

FILED

2013 SEP 26 AM 11:16

CLERK U.S. DISTRICT COURT
CENTRAL DISTRICT OF CALIF.
SANTA ANA

BY LAW

1 LOCKE LORD LLP
2 Brandon J. Witkow (SBN 210443)
3 bwitkow@lockelord.com
4 300 South Grand Avenue, Suite 2600
5 Los Angeles, California 90071
6 Tel: (213) 485-1500
7 Fax: (213) 485-1200

8 OSBORNE LAW LLC
9 John W. Osborne (*Admitted Pro Hac Vice*)
10 josborne@osborneipl.com
11 33 Habitat Lane
12 Cortlandt Manor, New York 10567
13 Tel: (914) 714-5936
14 Fax: (914) 734-7333

15 WATTS LAW OFFICES
16 Ethan M. Watts (SBN 234441)
17 emw@ewattslaw.com
18 12340 El Camino Real, Suite 430
19 San Diego, California 92130
20 Tel: (858) 509-0808
21 Fax: (619) 878-5784

22 *Attorneys for Plaintiff & Counter-Defendant*
23 AMERANTH, INC.

24 UNITED STATES DISTRICT COURT
25 CENTRAL DISTRICT OF CALIFORNIA

26 AMERANTH, INC., a Delaware)
27 corporation,)
28)
Plaintiff,)
vs.)
GENESIS GAMING SOLUTIONS, INC.)
et al.)
Defendants.)

Case No. SACV11-0189-AG (RNBX)
[Consolidated with 8:13-00720-AG-RNB]
**THIRD AMENDED COMPLAINT
FOR PATENT INFRINGEMENT**
[DEMAND FOR JURY TRIAL]

Locke Lord LLP
300 South Grand Avenue, Suite 2600
Los Angeles, CA 90071-3119

ORIGINAL

1 _____)
2 AND RELATED COUNTERCLAIMS)
3 _____)

4 **THIRD AMENDED COMPLAINT**

5 Plaintiff Ameranth, Inc., for its Third Amended Complaint against Genesis
6 Gaming Solutions, Inc., IT Casino Solutions LLC, El Dorado Enterprises, Inc., dba
7 Hustler Casino, California Commerce Club, Inc. dba Commerce Casino & DOES 1-
8 10 hereby asserts its Second Claim for patent infringement of U.S. Pat. No. 7,878,909
9 against Genesis Gaming Solutions, Inc. and avers as follows:

10 **PARTIES**

11 1. Plaintiff Ameranth, Inc. (“Plaintiff” or “Ameranth”) is a Delaware
12 corporation having a principal place of business at 5820 Oberlin Drive, Suite 202, San
13 Diego, California 92121. Ameranth manufactures and sells, *inter alia*, gaming
14 information technology solutions under the trademarks 21st Century Casino™
15 (“21CC”), Poker Room Manager (“PRM”) and others, including casino waitlisting,
16 tournament, marquee, player tracking and dealer coordination products and solutions.

17 2. Defendant Genesis Gaming Solutions, Inc. (“Genesis”) is, on information
18 and belief, a Texas corporation having a principal place of business at 25003 Pitkin
19 Road, Spring, Texas 77386. On information and belief, Defendant Genesis makes,
20 uses, sells and/or offers for sale gaming information technology products, software,
21 components and/or systems within this Judicial District including products, software,
22 components and/or systems including casino waitlisting, player tracking, tournament,
23 dealer coordination and marquee solutions.

24 3. Defendant IT Casino Solutions, LLC (“ITCS”) is, on information and
25 belief, a California limited liability corporation having a principal place of business at
26 7310 E. Paseo Tampico, Anaheim Hills, California 92808. On information and belief,
27 Defendant ITCS makes, uses, sells and/or offers for sale gaming information
28 technology products, software, components and/or systems within this Judicial

Locke Lord LLP
300 South Grand Avenue, Suite 2600
Los Angeles, CA, 90071-3119

Locke Lord LLP
300 South Grand Avenue, Suite 2600
Los Angeles, CA, 90071-3119

1 District including products, software, components and/or systems including casino
2 waitlisting, player tracking, tournament, marquee and dealer coordination solutions.

3 4. Defendant El Dorado Enterprises, Inc., dba Hustler Casino. (“Hustler
4 Casino”) is, on information and belief, a California corporation having a principal
5 place of business at 1000 W. Redondo Beach Blvd., Gardena, CA 90247. On
6 information and belief, Defendant Hustler Casino makes or uses gaming information
7 technology products, software, components and/or systems within this Judicial
8 District including products, software, components and/or systems including casino
9 waitlisting, tournament, player tracking, marquee and dealer coordination solutions.

10 5. Defendant California Commerce Club, Inc., dba Commerce Casino
11 (“Commerce”) is, on information and belief, a California corporation having a
12 principal place of business at 6131 E. Telegraph Road, Commerce, California 90040.
13 On information and belief, Defendant Commerce makes or uses gaming information
14 technology products, software, components and/or systems within this Judicial
15 District including products, software, components and/or systems including casino
16 waitlisting, player tracking, tournament, marquee and dealer coordination solutions.
17 Commerce purports to be the world’s largest poker room.

18 6. The true names and capacities of the Defendants named herein as DOES
19 1 through 10, inclusive, are unknown to Plaintiff at this time. Therefore, Plaintiff sues
20 said Defendants by such fictitious names. Plaintiff will amend this complaint to
21 allege these Defendants’ true names and capacities when they have been ascertained.

22 **JURISDICTION AND VENUE**

23 7. This is an action for patent infringement arising under the Patent Laws of
24 the United States, 35 U.S.C. §§ 271, 281-285.

25 8. This Court has subject matter jurisdiction pursuant to 28 U.S.C. §§ 1331
26 and 1338(a).

27 9. On information and belief, defendant Genesis has engaged in (a) the
28 offer for sale and sale of gaming technology services, products and/or components in

Locke Lord LLP
300 South Grand Avenue, Suite 2600
Los Angeles, CA, 90071-3119

1 the United States, including this Judicial District, including services, products,
2 software, components and/or systems including casino waitlisting, player tracking,
3 tournament, dealer coordination and marquee solutions under the “BRAVO”
4 trademark and/or tradename (b) the installation and maintenance of said services,
5 products, software, components and/or systems in gaming and/or casino information
6 technology systems in the United States, including this Judicial District and (c) the use
7 of gaming information technology systems comprising said services, products,
8 software, components and/or systems in the U.S., including this Judicial District.

9 10. This Court has personal jurisdiction over defendant Genesis as Genesis
10 has committed acts of patent infringement in this Judicial District including, *inter alia*,
11 making, using, offering for sale, and/or selling infringing services, products, software,
12 components and/or systems in this Judicial District.

13 11. On information and belief, defendant Genesis has knowingly and actively
14 infringed, contributed to infringement and/or have induced others to commit such acts
15 of infringement in this Judicial District.

16 12. On information and belief, defendant ITCS has engaged in (a) the offer
17 for sale and sale of gaming technology services, products and/or components in the
18 United States, including this Judicial District, including services, products, software,
19 components and/or systems including casino waitlisting, marquee, player tracking and
20 dealer coordination solutions under the “IT Casino Solutions,” “ITC,” “ITCS” and/or
21 “ISIS M3” trademarks and/or tradenames (b) the installation and maintenance of said
22 services, products, software, components and/or systems in gaming and/or casino
23 information technology systems in the United States, including this Judicial District
24 and (c) the use of gaming information technology systems comprising said services,
25 products, software, components and/or systems in the U.S., including this Judicial
26 District.

27 13. This Court has personal jurisdiction over defendant ITCS as ITCS has
28 committed acts of patent infringement in this Judicial District including, *inter alia*,

Locke Lord LLP
300 South Grand Avenue, Suite 2600
Los Angeles, CA, 90071-3119

1 making, using, offering for sale, and/or selling infringing services, products, software,
2 components and/or systems in this Judicial District.

3 14. On information and belief, defendant ITCS has knowingly and actively
4 infringed, contributed to infringement and/or have induced others to commit such acts
5 of infringement in this Judicial District.

6 15. On information and belief, defendant Hustler Casino has engaged in (a)
7 the installation, maintenance and use of gaming technology services, products and/or
8 components in the United States, including this Judicial District, including services,
9 products, software, components and/or systems including casino waitlisting, marquee,
10 player tracking, tournament and dealer coordination solutions either itself or in concert
11 with defendant ITCS..

12 16. This Court has personal jurisdiction over defendant Hustler Casino as
13 Hustler Casino has committed acts of patent infringement in this Judicial District
14 including, *inter alia*, making or using infringing services, products, software,
15 components and/or systems in this Judicial District.

16 17. On information and belief, defendant Hustler Casino has knowingly and
17 actively infringed, contributed to infringement and/or have induced others to commit
18 such acts of infringement in this Judicial District.

19 18. On information and belief, defendant Commerce has engaged in (a) the
20 installation, maintenance and use of gaming technology services, products and/or
21 components in the United States, including this Judicial District, including services,
22 products, software, components and/or systems including casino waitlisting,
23 tournament, player tracking, marquee and dealer coordination solutions either itself or
24 in concert with defendants Genesis and/or ITCS.

25 19. This Court has personal jurisdiction over defendant Commerce as
26 Commerce has committed acts of patent infringement in this Judicial District
27 including, *inter alia*, making or using infringing services, products, software,
28 components and/or systems in this Judicial District.

1 20. On information and belief, defendant Commerce has knowingly and
2 actively infringed, contributed to infringement and/or have induced others to commit
3 such acts of infringement in this Judicial District.

4 21. Venue is proper in this Judicial District pursuant to 28 U.S.C. §§ 1391(b)
5 and (c) and 1400(b) as regards to all defendants both separately and together.

6 **BACKGROUND**

7 22. Ameranth was established in 1996 to develop and provide innovative
8 information system and data synchronization technology solutions for the hospitality
9 industry. Ameranth has been widely recognized as a technology leader in the
10 provision of wireless and internet-based systems and services to, *inter alia*,
11 restaurants, hotels, casinos, cruise ships and sports venues and has been awarded
12 multiple “best product” technology awards, as well as been widely recognized as an
13 innovator by both national and hospitality/gaming publications. Ameranth’s
14 inventions enable, in relevant part, gaming and/or casino waitlisting, tournament,
15 player tracking, marquee and/or dealer coordination functions. Ameranth’s Poker
16 Room Manager (PRM) family of products have been installed in many of the largest
17 and most successful poker rooms around the world and in the United States including
18 within this Judicial District (which is home to the three largest poker rooms in the
19 world and includes the greatest concentration of poker-related activities in the world).

20 23. Development of the inventions leading to the patents-in-suit began at
21 least as early as late 2001 at a time when there were no integrated gaming or casino
22 waitlisting, marquee, player tracking, tournament or dealer coordination information
23 technology solutions. Ameranth’s later-acquired division, QueueOS, conceived and
24 developed its breakthrough innovations to provide systemic integrated solutions
25 directed to uniquely meeting these previously unmet industry needs. After acquiring
26 QueueOS in 2006, Ameranth merged product features from the QueueOS product line
27 into its Poker Room Manager (PRM) family of products. Ameranth has expended
28

Locke Lord LLP
300 South Grand Avenue, Suite 2600
Los Angeles, CA, 90071-3119

Locke Lord LLP
300 South Grand Avenue, Suite 2600
Los Angeles, CA, 90071-3119

1 considerable effort and resources in inventing, developing and marketing its
2 inventions and protecting its rights therein.

3 24. Ameranth’s pioneering inventions have been widely adopted throughout
4 the gaming industry and are thus now essential to the efficient operations of modern
5 casino and/or gaming enterprises of the 21st Century. Ameranth’s solutions have
6 been adopted throughout the hospitality/gaming industry, including by Genesis, ITCS,
7 Hustler Casino, Commerce and many others.

8 25. The widespread adoption of Ameranth’s technology by industry leaders
9 and the wide acclaim received by Ameranth for its many technological innovations are
10 just some of the many confirmations of the breakthrough aspects of Ameranth’s
11 inventions. Ameranth has received more than 10 major technology awards and has
12 been widely recognized as an innovator.

13 **FIRST CLAIM FOR RELIEF**
14 **Patent Infringement (U.S. Pat. No. 7,431,650)**
15 **(35 U.S.C. § 271)**

16 26. Plaintiff reiterates and incorporates the allegations set forth in paragraphs
17 1-25 above as if fully set forth herein.

18 27. On October 7, 2008, United States Patent No. 7,431,650 entitled “Casino
19 Poker and Dealer Management System” (“the ‘650 patent”) (attached hereto as
20 Exhibit A) was duly and legally issued by the United States Patent & Trademark
21 Office.

22 28. Plaintiff Ameranth is the lawful owner by assignment of all right, title
23 and interest in and to the ‘650 patent.

24 29. On information and belief, defendant Genesis has infringed the ‘650
25 patent in violation of 35 U.S.C. § 271(a) by making, using, offering for sale and/or
26 selling infringing gaming and/or casino information technology systems including but
27 not limited to systems including waitlisting, tournament, player tracking and marquee
28 functions under the BRAVO trademark and/or tradename in the U.S. without authority

Locke Lord LLP
300 South Grand Avenue, Suite 2600
Los Angeles, CA, 90071-3119

1 or license from Ameranth.

2 30. On information and belief, defendant Genesis has actively induced others
3 to infringe the '650 patent in violation of 35 U.S.C. § 271(b) by knowingly
4 encouraging, aiding and abetting gaming and/or casino users to use infringing systems
5 and services including but not limited to systems and services including waitlisting,
6 tournament, player tracking, and marquee functions under the BRAVO trademark
7 and/or tradename in the U.S. without authority or license from Ameranth.

8 31. On information and belief, defendant Genesis has contributorily infringed
9 the '650 patent in violation of 35 U.S.C. § 271(c) by offering to sell and/or selling
10 components of systems on which claims of the '650 patent read, constituting a
11 material part of the invention, knowing that the components were especially adapted
12 for use in systems which infringe claims of the '650 patent to distributors and/or to
13 gaming and/or casino users for use in infringing systems and services including but
14 not limited to systems and services including waitlisting, tournament, player tracking,
15 and marquee functions under the BRAVO trademark and/or tradename in the U.S.
16 without authority or license from Ameranth.

17 32. On information and belief, defendant ITCS has infringed the '650 patent
18 in violation of 35 U.S.C. § 271(a) by making, using, offering for sale and/or selling
19 infringing gaming and/or casino information technology systems including but not
20 limited to systems including waitlisting, player tracking, marquee and dealer
21 scheduling functions under the IT Casino Solutions, ITC, ITCS and/or ISIS M3
22 trademarks and/or tradenames in the U.S. without authority or license from Ameranth.

23 33. On information and belief, defendant ITCS has actively induced others to
24 infringe the '650 patent in violation of 35 U.S.C. § 271(b) by knowingly encouraging,
25 aiding and abetting gaming and/or casino users to use infringing systems and services
26 including but not limited to systems and services including waitlisting, player
27 tracking, ,marquee and dealer scheduling functions under the IT Casino Solutions,
28 ITC, ITCS and/or ISIS M3 trademarks and/or tradenames in the U.S. without

Locke Lord LLP
300 South Grand Avenue, Suite 2600
Los Angeles, CA, 90071-3119

1 authority or license from Ameranth.

2 34. On information and belief, defendant ITCS has contributorily infringed
3 the '650 patent in violation of 35 U.S.C. § 271(c) by offering to sell and/or selling
4 components of systems on which claims of the '650 patent read, constituting a
5 material part of the invention, knowing that the components were especially adapted
6 for use in systems which infringe claims of the '650 patent to distributors and/or to
7 gaming and/or casino users for use in infringing systems and services including but
8 not limited to systems and services including waitlisting, player tracking, marquee and
9 dealer scheduling functions under the IT Casino Solutions, ITC, ITCS and/or ISIS M3
10 trademarks and/or tradenames in the U.S. without authority or license from Ameranth.

11 35. On information and belief, defendant Hustler Casino has infringed the
12 '650 patent in violation of 35 U.S.C. § 271(a) by making or using infringing gaming
13 and/or casino information technology systems including but not limited to systems
14 including waitlisting, tournament, player tracking, marquee and dealer coordination
15 functions either itself or in concert with defendant ITCS in the U.S. without authority
16 or license from Ameranth.

17 36. On information and belief, defendant Hustler Casino has actively induced
18 others to infringe the '650 patent in violation of 35 U.S.C. § 271(b) by knowingly
19 encouraging, aiding and abetting gaming and/or casino users to use infringing systems
20 and services including but not limited to systems and services including waitlisting,
21 tournament, player tracking, marquee and dealer coordination functions either itself or
22 in concert with defendant ITCS in the U.S. without authority or license from
23 Ameranth.

24 37. On information and belief, defendant Hustler Casino has contributorily
25 infringed the '650 patent in violation of 35 U.S.C. § 271(c) by providing components
26 of systems on which claims of the '650 patent read, constituting a material part of the
27 invention, knowing that the components were especially adapted for use in systems
28 which infringe claims of the '650 patent, to gaming and/or casino users for use in

Locke Lord LLP
300 South Grand Avenue, Suite 2600
Los Angeles, CA, 90071-3119

1 infringing systems and services including but not limited to systems and services
2 including waitlisting, tournament, player tracking, marquee and dealer coordination
3 functions either itself or in concert with defendant ITCS without authority or license
4 from Ameranth.

5 38. On information and belief, defendant Commerce has infringed the ‘650
6 patent in violation of 35 U.S.C. § 271(a) by making and/or using infringing gaming
7 and/or casino information technology systems including but not limited to systems
8 including waitlisting, tournament, player tracking and marquee functions either itself
9 or in concert with defendants Genesis and/or ITCS in the U.S. without authority or
10 license from Ameranth.

11 39. On information and belief, defendant Commerce has actively induced
12 others to infringe the ‘650 patent in violation of 35 U.S.C. §271(b) by knowingly
13 encouraging, aiding and abetting gaming and/or casino users to use infringing systems
14 and services including but not limited to systems and services including waitlisting,
15 tournament, player tracking and marquee functions either itself or in concert with
16 defendants Genesis and/or ITCS in the U.S. without authority or license from
17 Ameranth.

18 40. On information and belief, defendant Commerce has contributorily
19 infringed the ‘650 patent in violation of 35 U.S.C. §271(c) by providing components
20 of systems on which claims of the ‘650 patent read, constituting a material part of the
21 invention, knowing that the components were especially adapted for use in systems
22 which infringe claims of the ‘650 patent, to gaming and/or casino users for use in
23 infringing systems and services including but not limited to systems and services
24 including waitlisting, tournament, player tracking and marquee functions either itself
25 or in concert with defendants Genesis and/or ITCS without authority or license from
26 Ameranth.

27 41. On information and belief, the infringement of the ‘650 patent by all
28 defendants has been in willful disregard of Ameranth’s patent rights, making this an

Locke Lord LLP
300 South Grand Avenue, Suite 2600
Los Angeles, CA, 90071-3119

1 exceptional case within the meaning of 35 U.S.C. § 285.

2 42. The aforesaid infringing activity has caused damage to plaintiff,
3 including loss of profits from sales they would have made but for the infringements.
4 Unless enjoined, the aforesaid infringing activity will continue and cause irreparable
5 injury to plaintiff for which there is no adequate remedy at law.

6 **SECOND CLAIM FOR RELIEF**

7 **Patent Infringement (U.S. Pat. No. 7,878,909)**

8 **(35 U.S.C. § 271)**

9 43. Plaintiff reiterates and incorporates the allegations set forth in paragraphs
10 1-42 above as if fully set forth herein.

11 44. On February 1, 2011, United States Patent No. 7,878,909 entitled
12 “Products and Processes for Operations Management of casino, Leisure and
13 Hospitality Industry” (“the ‘909 patent”) (attached hereto as Exhibit B) was duly and
14 legally issued by the United States Patent & Trademark Office.

15 45. Plaintiff Ameranth is the lawful owner by assignment of all right, title
16 and interest in and to the ‘909 patent.

17 46. On information and belief, defendant ITCS has infringed the ‘909 patent
18 in violation of 35 U.S.C. § 271(a) by making, using, offering for sale and/or selling
19 infringing gaming and/or casino information technology systems and services
20 including but not limited to systems and services including dealer coordination
21 functions under the IT Casino Solutions, ITC, ITCS and/or ISIS M3 trademarks
22 and/or tradenames in the U.S. without authority or license from Ameranth.

23 47. On information and belief, defendant ITCS has actively induced others to
24 infringe the ‘909 patent in violation of 35 U.S.C. § 271(b) by knowingly encouraging,
25 aiding and abetting gaming and/or casino users to use infringing systems and services
26 including but not limited to systems and services including dealer coordination
27 functions under the IT Casino Solutions, ITC, ITCS and/or ISIS M3 trademarks
28 and/or tradenames in the U.S. without authority or license from Ameranth.

Locke Lord LLP
300 South Grand Avenue, Suite 2600
Los Angeles, CA, 90071-3119

1 48. On information and belief, defendant ITCS has contributorily infringed
2 the '909 patent in violation of 35 U.S.C. § 271(c) by offering to sell and/or selling
3 components of systems on which claims of the '909 patent read, constituting a
4 material part of the invention, knowing that the components were especially adapted
5 for use in systems which infringe claims of the '909 patent to distributors and/or to
6 gaming and/or casino users for use in infringing systems and services including but
7 not limited to systems and services including dealer coordination functions under the
8 IT Casino Solutions, ITC, ITCS and/or ISIS M3 trademarks and/or tradenames in the
9 U.S. without authority or license from Ameranth.

10 49. On information and belief, defendant Hustler Casino has infringed the
11 '909 patent in violation of 35 U.S.C. § 271(a) by making or using infringing gaming
12 and/or casino information technology systems including but not limited to systems
13 including dealer coordination functions either itself or in concert with defendant ITCS
14 in the U.S. without authority or license from Ameranth.

15 50. On information and belief, defendant Hustler Casino has actively induced
16 others to infringe the '909 patent in violation of 35 U.S.C. § 271(b) by knowingly
17 encouraging, aiding and abetting gaming and/or casino users to use infringing systems
18 and services including but not limited to systems and services including dealer
19 coordination functions either itself or in concert with defendant ITCS in the U.S.
20 without authority or license from Ameranth.

21 51. On information and belief, defendant Hustler Casino has contributorily
22 infringed the '909 patent in violation of 35 U.S.C. § 271(c) by providing components
23 of systems on which claims of the '909 patent read, constituting a material part of the
24 invention, knowing that the components were especially adapted for use in systems
25 which infringe claims of the '909 patent, to gaming and/or casino users for use in
26 infringing systems and services including but not limited to systems and services
27 including dealer coordination functions either itself or in concert with defendant ITCS
28 without authority or license from Ameranth.

Locke Lord LLP
300 South Grand Avenue, Suite 2600
Los Angeles, CA, 90071-3119

1 52. [Withdrawn Per Settlement Agreement]

2 53. [Withdrawn Per Settlement Agreement]

3 54. [Withdrawn Per Settlement Agreement]

4 55. The aforesaid infringing activity has caused damage to plaintiff,
5 including loss of profits from sales they would have made but for the infringements.
6 Unless enjoined, the aforesaid infringing activity will continue and cause irreparable
7 injury to plaintiff for which there is no adequate remedy at law.

8 56. On information and belief, defendant Genesis has infringed the '909
9 patent in violation of 35 U.S.C. § 271(a) by making, using, offering for sale and/or
10 selling infringing gaming and/or casino information technology systems and services
11 including but not limited to systems and services including dealer coordination
12 functions under the Genesis and/or BRAVO trademarks and/or tradenames in the U.S.
13 without authority or license from Ameranth. Genesis publicly markets dealer
14 coordination functionality, *inter alia*, in its own product brochures and system
15 diagrams, and, further confirming Genesis' knowledge of its infringement of the '909
16 patent, Genesis unsuccessfully sought to invalidate the '909 patent through a failed
17 reexamination filing in the United States Patent Office specifically against the '909
18 patent.

19 57. On information and belief, defendant Genesis has actively induced others
20 to infringe the '909 patent in violation of 35 U.S.C. § 271(b) by knowingly
21 encouraging, aiding and abetting gaming and/or casino users to use infringing systems
22 and services including but not limited to systems and services including dealer
23 coordination functions under the Genesis and/or BRAVO trademarks and/or
24 tradenames in the U.S. without authority or license from Ameranth.

25 58. On information and belief, defendant Genesis has contributorily infringed
26 the '909 patent in violation of 35 U.S.C. § 271(c) by offering to sell and/or selling
27 components of systems on which claims of the '909 patent read, constituting a
28 material part of the invention, knowing that the components were especially adapted

Locke Lord LLP
300 South Grand Avenue, Suite 2600
Los Angeles, CA, 90071-3119

1 for use in systems which infringe claims of the '909 patent to distributors and/or to
2 gaming and/or casino users for use in infringing systems and services including but
3 not limited to systems and services including dealer coordination functions under the
4 Genesis and/or BRAVO trademarks and/or tradenames in the U.S. without authority
5 or license from Ameranth.

6 59. The aforesaid infringing activity as against Genesis with respect to the
7 '909 Patent has caused damage to plaintiff, including loss of profits from sales they
8 would have made but for the infringements. Unless enjoined, the aforesaid infringing
9 activity by Genesis will continue and cause irreparable injury to plaintiff for which
10 there is no adequate remedy at law.

11 60. The aforesaid infringing activities of Genesis have been done with
12 knowledge and willful disregard of Ameranth's patent rights, making this an
13 exceptional case within the meaning of 35 U.S.C. § 285. Genesis has had knowledge
14 of the '909 patent since February 2, 2011 when the original complaint in this action
15 was filed alleging infringement of the '909 patent against other defendants including
16 ITCS. Further, Genesis filed a reexamination request against the '909 patent in the
17 summer of 2011, which has since concluded with the confirmation of the majority of
18 the claims of the '909 patent. Genesis's deliberate decision to continue its infringing
19 activities after obtaining said knowledge constitutes objectively reckless behavior
20 justifying a finding of willfulness.

21 **PRAYER FOR RELIEF**

22 **WHEREFORE**, Plaintiff respectfully prays for judgment and an order against
23 defendants:

24 A. Adjudging that the manufacture, use, offer for sale and/or sale of
25 Genesis's products, services, software and/or hardware including those under the
26 BRAVO trademark and/or tradenames infringes both the '650 and '909 patents;

27 B. Adjudging that the manufacture, use, offer for sale and/or sale of ITCS's
28 products, services and/or software including those under the IT Casino Solutions, ITC,

Locke Lord LLP
300 South Grand Avenue, Suite 2600
Los Angeles, CA, 90071-3119

1 ITCS and/or ISIS M3 trademarks and/or tradenames infringes the ‘650 and ‘909
2 patents;

3 C. Adjudging that the making and/or use of Hustler Casino’s gaming and/or
4 casino waitlisting, player tracking, tournament, marquee and dealer coordination
5 products, services and/or software infringes the ‘650 and ‘909 patents;

6 D. Adjudging that the making and/or use of Commerce’s gaming and/or
7 casino waitlisting, tournament, player tracking and marquee products, services and/or
8 software infringes the ‘650 patent;

9 E. Adjudging that each of Genesis, ITCS, Hustler Casino and Commerce
10 has infringed, actively induced others to infringe and/or contributorily infringed, as
11 applicable, the ‘650 patent;

12 F. Adjudging that infringement of the ‘650 patent by Genesis, ITCS, Hustler
13 Casino and Commerce, as applicable, has been willful;

14 G. Enjoining Genesis, ITCS, Hustler Casino and Commerce, their officers,
15 directors, employees, attorneys, agents, representatives, parents, subsidiaries, affiliates
16 and all other persons acting in concert, participation or privity with them, and their
17 successors and assigns, from infringing, contributorily infringing and/or inducing
18 others to infringe the ‘650 patent, as applicable;

19 H. Adjudging that each of Genesis, ITCS, and Hustler Casino has infringed,
20 actively induced others to infringe and/or contributorily infringed, as applicable, the
21 ‘909 patent;

22 I. Adjudging that infringement of the ‘909 patent by Genesis has been
23 willful;

24 J. Enjoining Genesis, ITCS, and Hustler, their officers, directors,
25 employees, attorneys, agents, representatives, parents, subsidiaries, affiliates and all
26 other persons acting in concert, participation or privity with them, and their successors
27 and assigns, from infringing, contributorily infringing and/or inducing others to
28 infringe the ‘909 patent, as applicable

1 K. Awarding Ameranth the damages it has sustained by reason of
2 defendants' infringement, together with interest and costs pursuant to 35 U.S.C. §
3 284;

4 L. Awarding Ameranth increased damages of three times the amount found
5 or assessed by reason of the willful and deliberate nature of defendants' acts of
6 infringement pursuant to 35 U.S.C. § 284;

7 M. Adjudging this to be an exceptional case and awarding Ameranth its
8 attorney fees pursuant to 35 U.S.C. §285; and

9 N. Awarding to Ameranth such other and further relief that this Court may
10 deem just and proper.

11
12
13
14
15
16
17
18
19
20
21
22
23
24
25
26
27
28

Locke Lord LLP
300 South Grand Avenue, Suite 2600
Los Angeles, CA, 90071-3119

Dated: September 25, 2013

Respectfully submitted,

LOCKE LORD LLP

By: _____

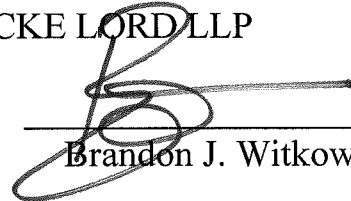

Brandon J. Witkow

OSBORNE LAW LLC

John W. Osborne

WATTS LAW OFFICES

Ethan M. Watts

Attorneys for Plaintiff and Counter-defendant
AMERANTH, INC.

DEMAND FOR JURY TRIAL

1
2
3
4
5
6
7
8
9
10
11
12
13
14
15
16
17
18
19
20
21
22
23
24
25
26
27
28

Plaintiff Ameranth, Inc., hereby demand trial by jury on all issues so triable,
pursuant to Rule 38 of the Federal Rules of Civil Procedure.

Dated: September 25, 2013

Respectfully submitted,

LOCKE LORD LLP

By: _____

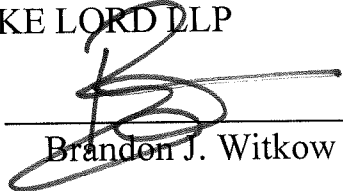
Brandon J. Witkow

OSBORNE LAW LLC

John W. Osborne

WATTS LAW OFFICES

Ethan M. Watts

*Attorneys for Plaintiff and Counter-defendant
AMERANTH, INC.*

Locke Lord LLP
300 South Grand Avenue, Suite 2600
Los Angeles, CA, 90071-3119

EXHIBIT "A"

Exhibit A, Pg. 18



US007878909B2

(12) **United States Patent**
Kessman et al.

(10) **Patent No.:** **US 7,878,909 B2**
 (45) **Date of Patent:** **Feb. 1, 2011**

(54) **PRODUCTS AND PROCESSES FOR OPERATIONS MANAGEMENT OF CASINO, LEISURE AND HOSPITALITY INDUSTRY**

(75) Inventors: **Mark D. Kessman**, Pound Ridge, NY (US); **Sean P. McCauley**, Danbury, CT (US)

(73) Assignee: **Ameranth, Inc.**, San Diego, CA (US)

(*) Notice: Subject to any disclaimer, the term of this patent is extended or adjusted under 35 U.S.C. 154(b) by 484 days.

(21) Appl. No.: **12/043,829**

(22) Filed: **Mar. 6, 2008**

(65) **Prior Publication Data**

US 2008/0281666 A1 Nov. 13, 2008

Related U.S. Application Data

(62) Division of application No. 10/452,231, filed on May 30, 2003, now Pat. No. 7,431,650.

(60) Provisional application No. 60/384,565, filed on May 30, 2002, provisional application No. 60/429,383, filed on Nov. 25, 2002.

(51) **Int. Cl.**
G06F 19/00 (2006.01)

(52) **U.S. Cl.** 463/42; 463/16

(58) **Field of Classification Search** 463/25-42, 463/17-20; 705/14.12, 14.41, 30; 703/1; 701/300; 726/5; 273/236

See application file for complete search history.

(56) **References Cited**

U.S. PATENT DOCUMENTS

4,926,327 A 5/1990 Sidley

5,586,936 A	12/1996	Bennett et al.	
5,711,715 A	1/1998	Ringo et al.	
5,957,776 A	9/1999	Iloehne	
6,093,100 A	7/2000	Singer et al.	
6,117,011 A	9/2000	Lvov	
6,174,237 B1	1/2001	Stephenson	
6,267,671 B1 *	7/2001	Hogan	463/25
6,299,534 B1	10/2001	Breeding et al.	
6,382,629 B1	5/2002	Hill	
6,582,301 B2	6/2003	Hill	
6,672,589 B1	1/2004	Lemke et al.	
6,676,517 B2 *	1/2004	Beavers	463/25
6,729,959 B1	5/2004	Moore et al.	
6,767,284 B1	7/2004	Koza	
7,018,291 B1	3/2006	Lemke et al.	
7,255,642 B2	8/2007	Sines et al.	
7,306,516 B2	12/2007	Losilovsky	
7,460,863 B2 *	12/2008	Steelberg et al.	455/419
2002/0123377 A1	9/2002	Shulman	
2003/0139190 A1 *	7/2003	Steelberg et al.	455/456
2007/0004518 A1	1/2007	Friesen et al.	

* cited by examiner

Primary Examiner—Peter DungBa Vo

Assistant Examiner—Masud Ahmed

(74) *Attorney, Agent, or Firm*—Locke Lord Bissell & Liddell T.L.P.

(57) **ABSTRACT**

In various embodiments of this invention, a suite of customized computer software applications, a linked or wireless computer network and accessory components cooperate to enhance and extend customer and employee resource management in the casino/gaming environment.

26 Claims, 95 Drawing Sheets

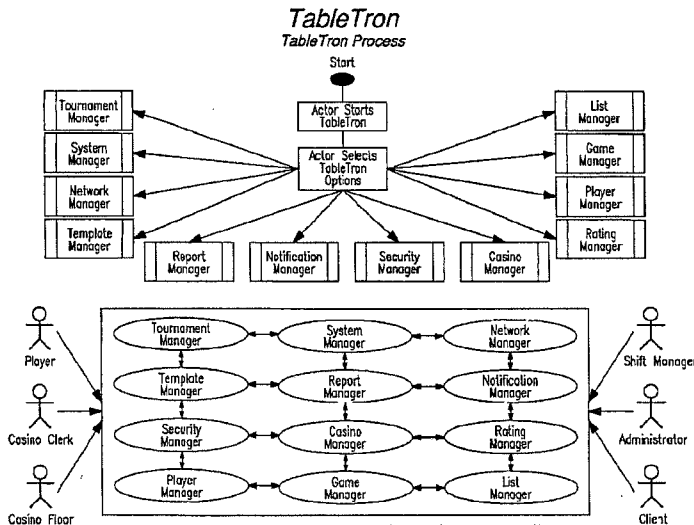

TableTron offers a multitude of processes of which certain Actors can utilize. Depending on the function at hand Actors will initiate, monitor, and react to certain product processes.

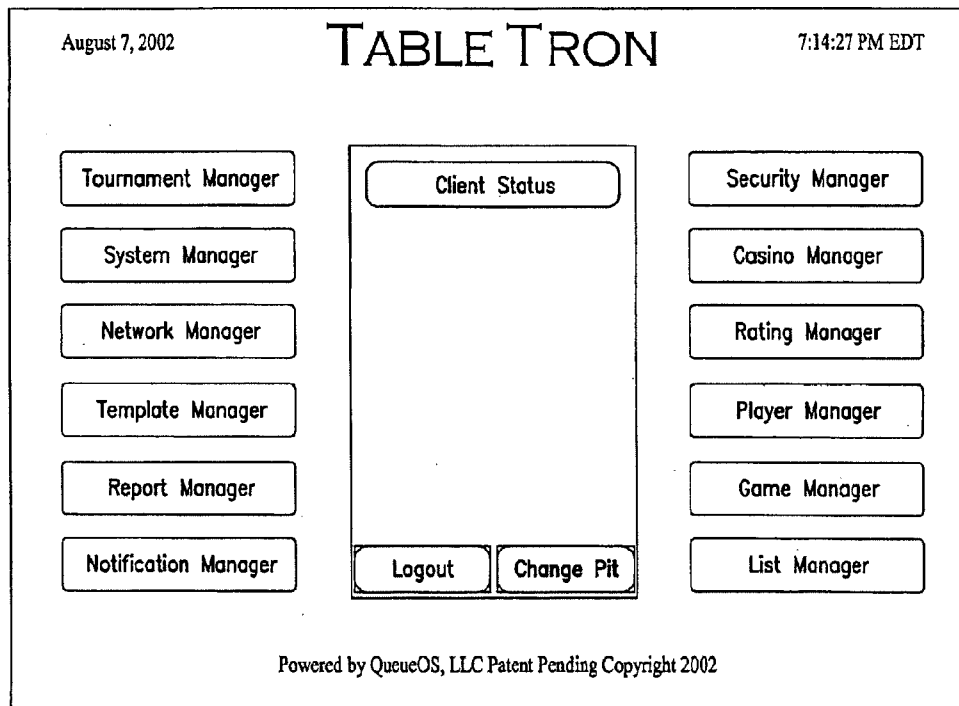
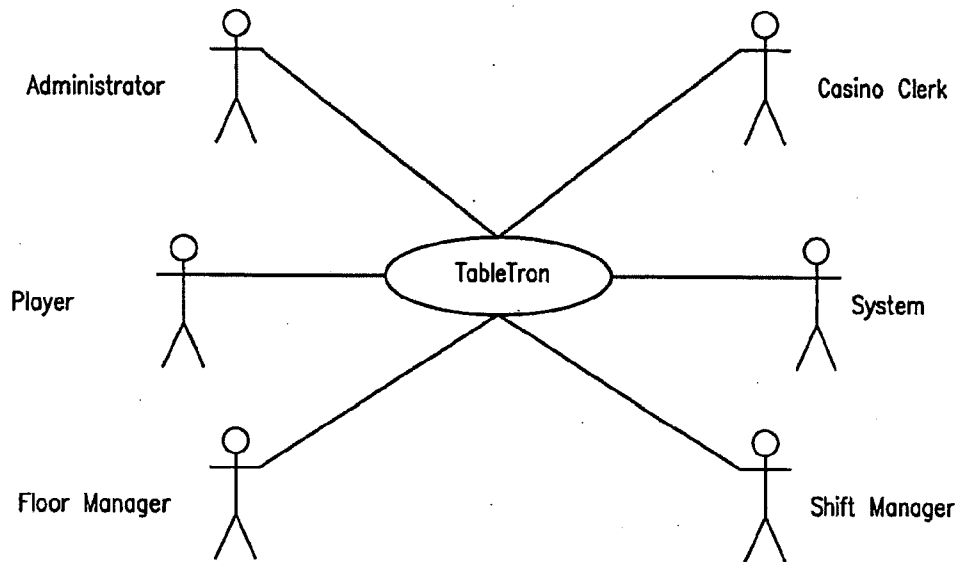

FIG. 1



TableTron offers electronic data efficiency within game, seat, rating, player, report, and system management incorporating a client-server based real-time application. TableTron is fully capable of managing the gateway (front-end) processes of casino venues by using intelligent an application model.

FIG. 2

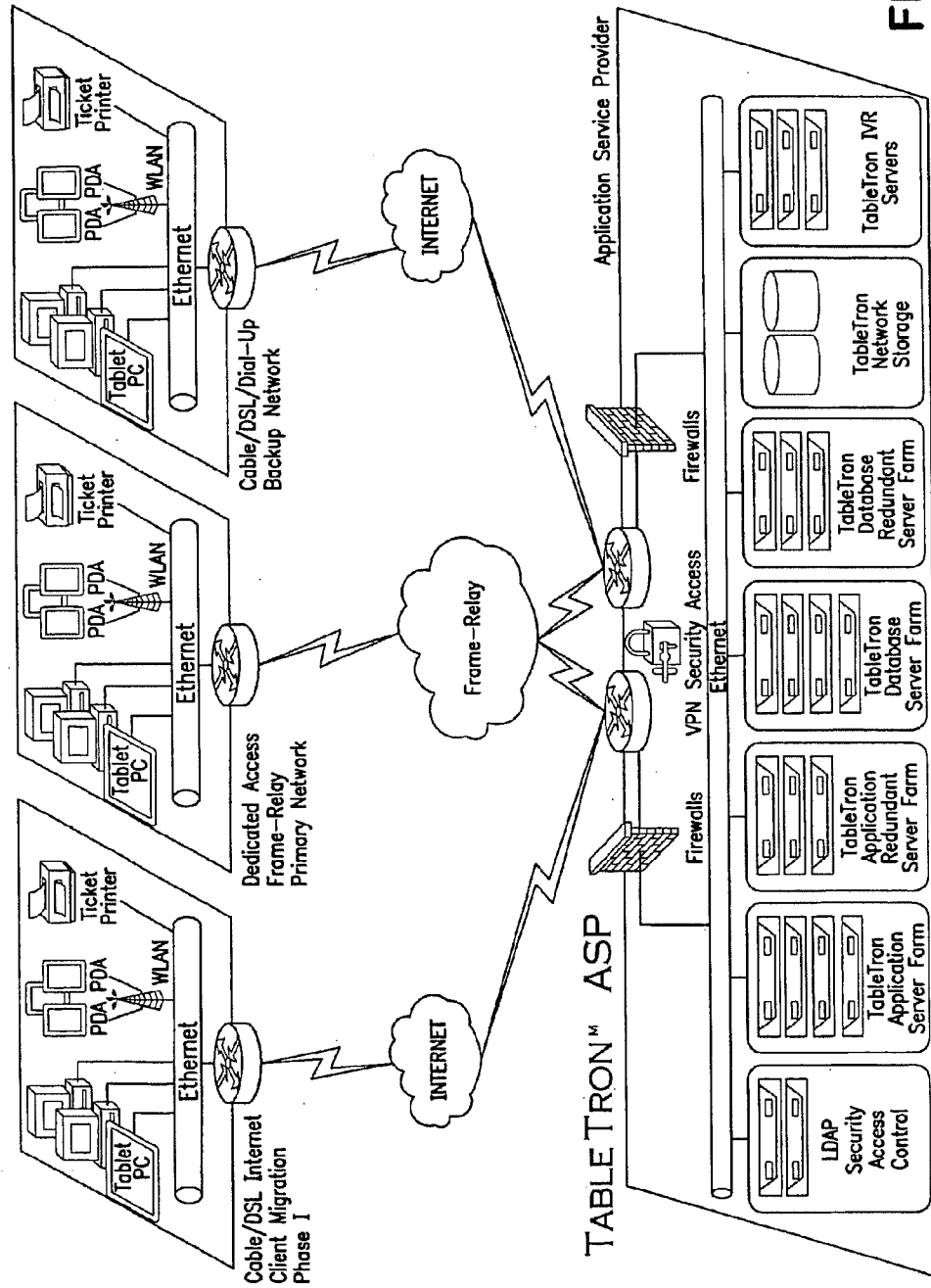

FIG. 3

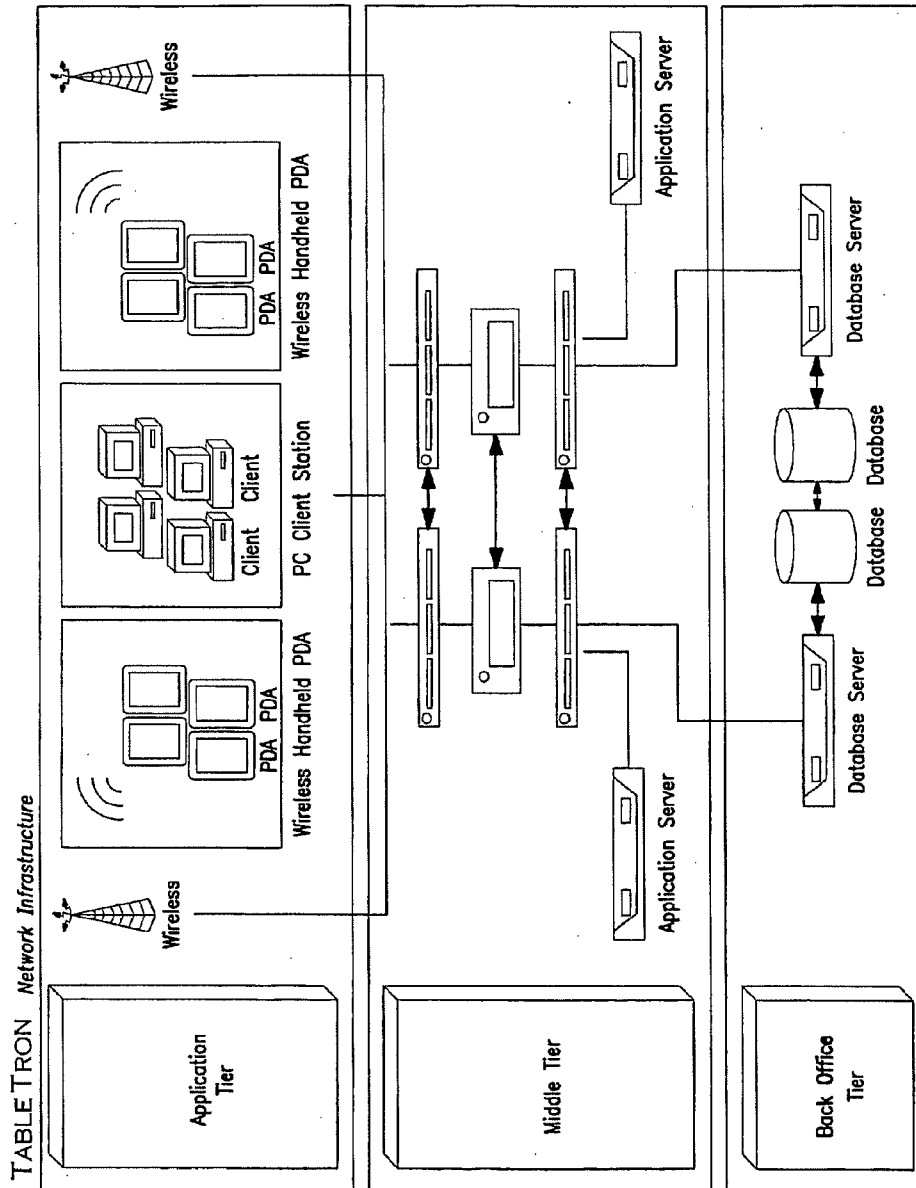
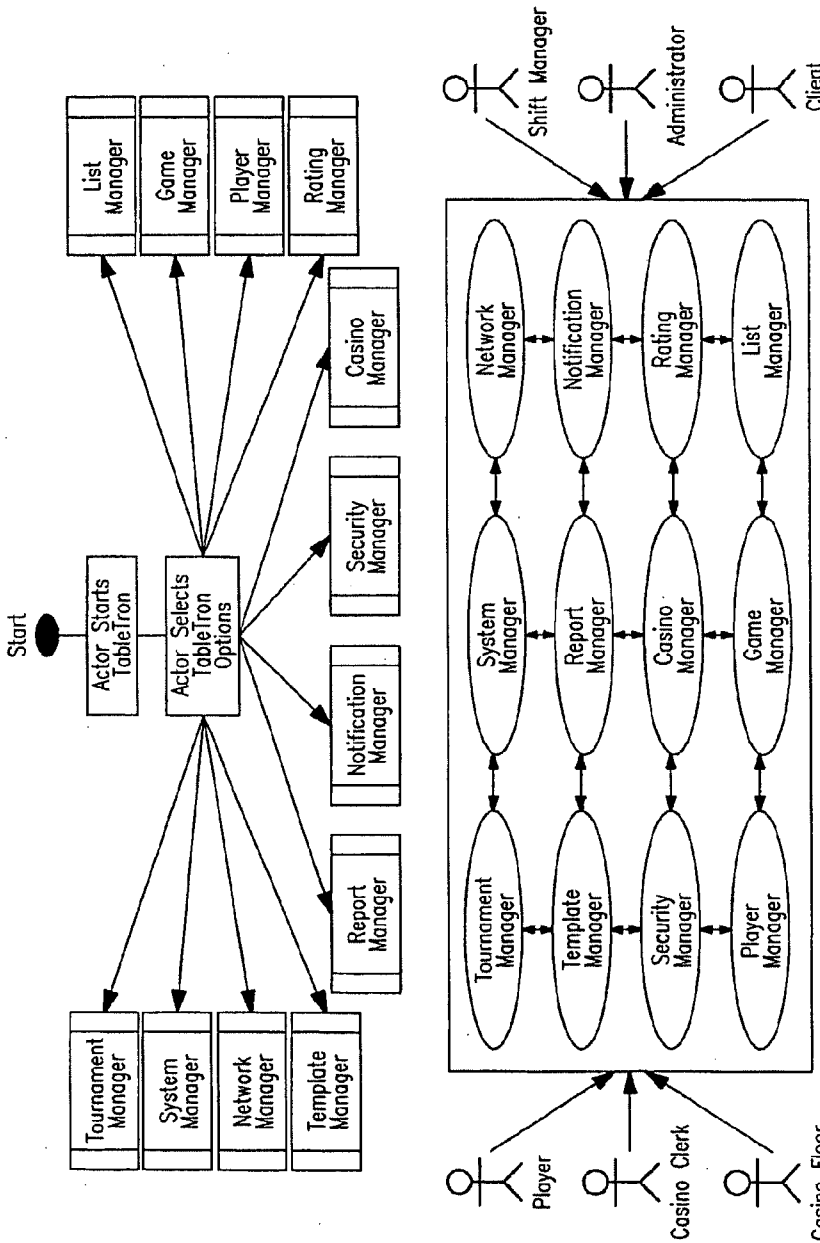

FIG. 4

TableTron
TableTron Process



TableTron offers a multitude of processes of which certain Actors can utilize. Depending on the function at hand Actors will initiate, monitor, and react to certain product processes.

FIG. 5

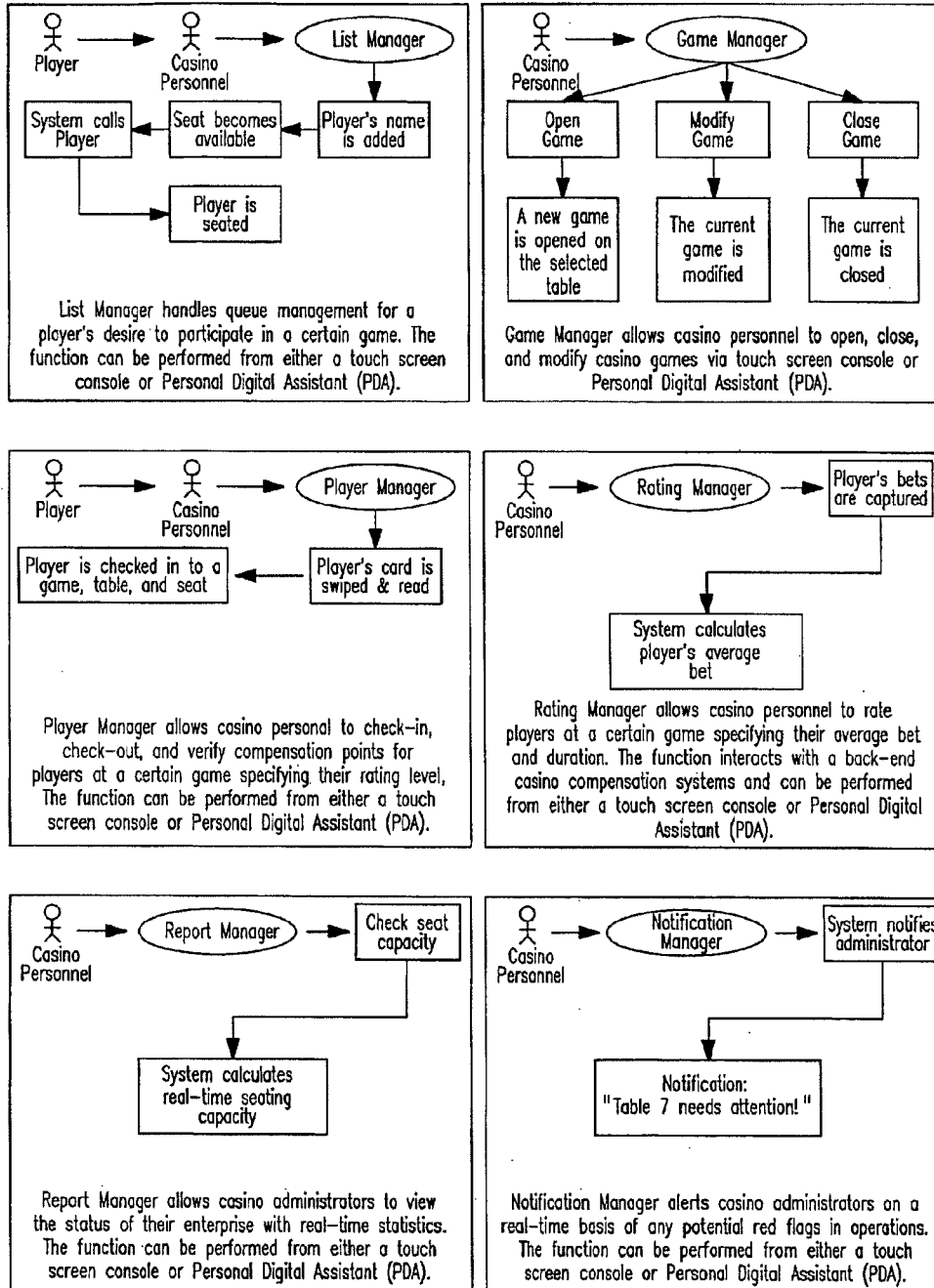

FIG. 6

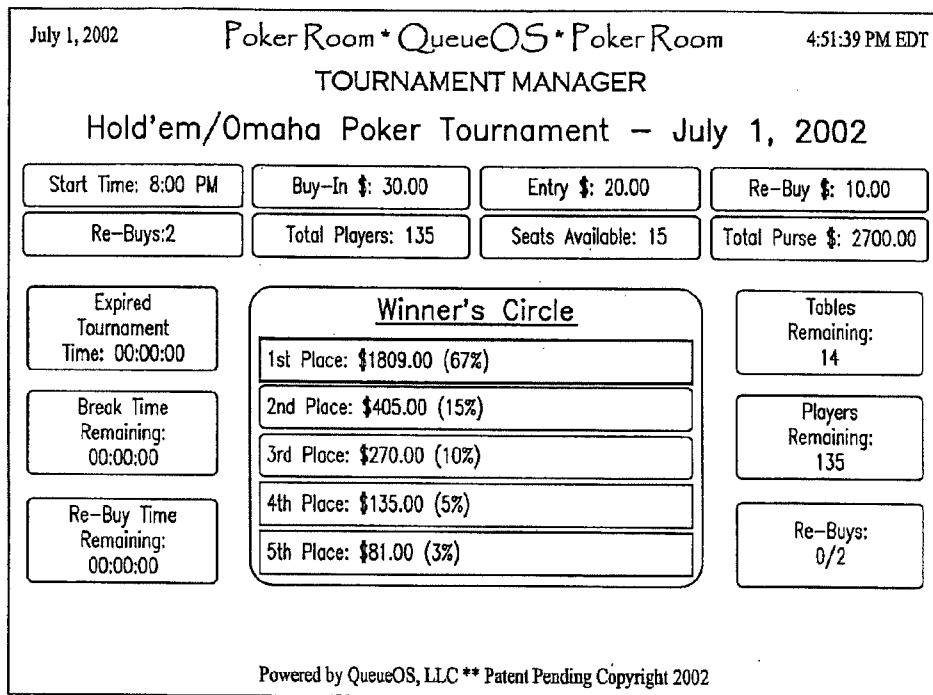

FIG. 7

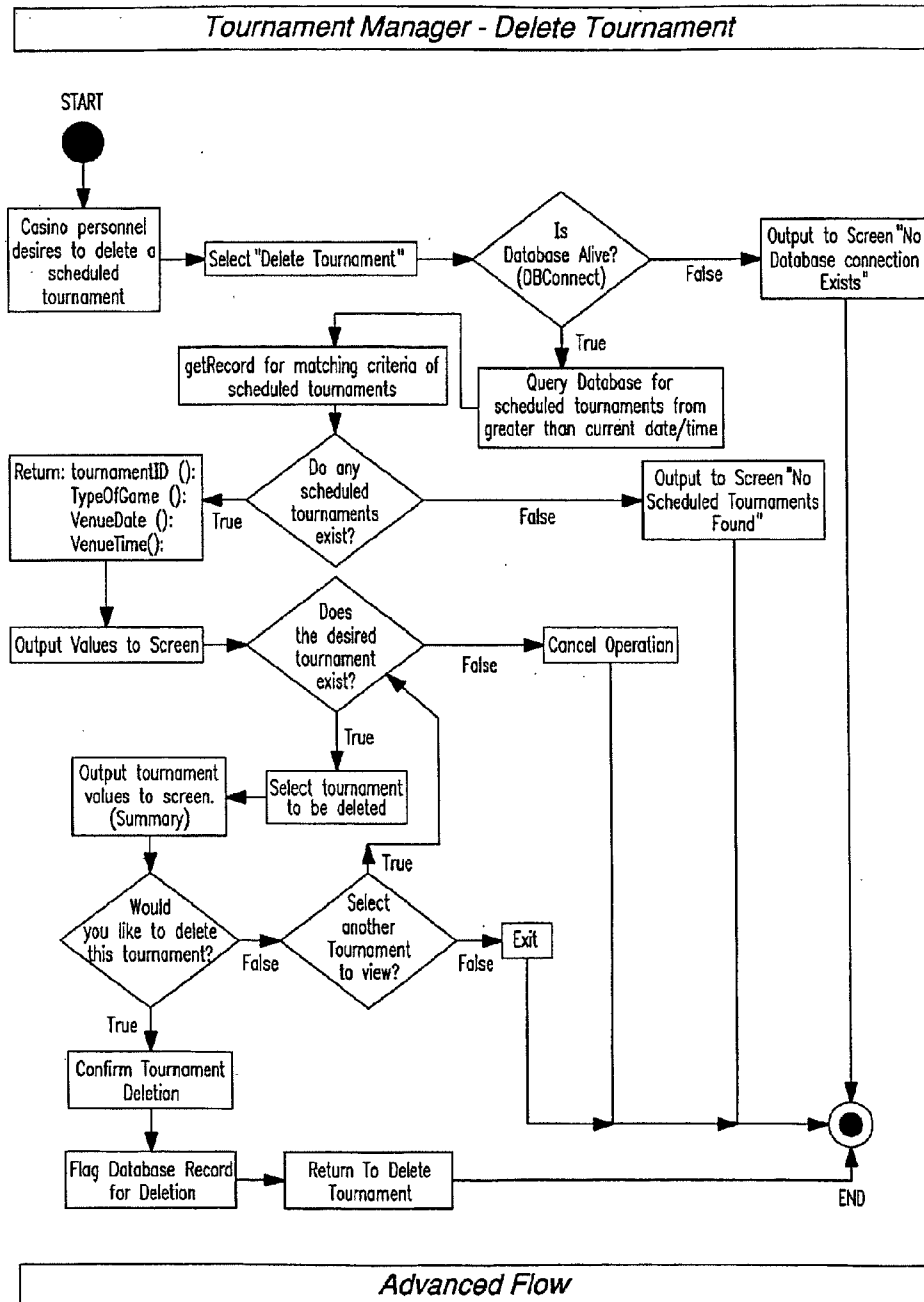

FIG. 8

U.S. Patent

Feb. 1, 2011

Sheet 9 of 95

US 7,878,909 B2

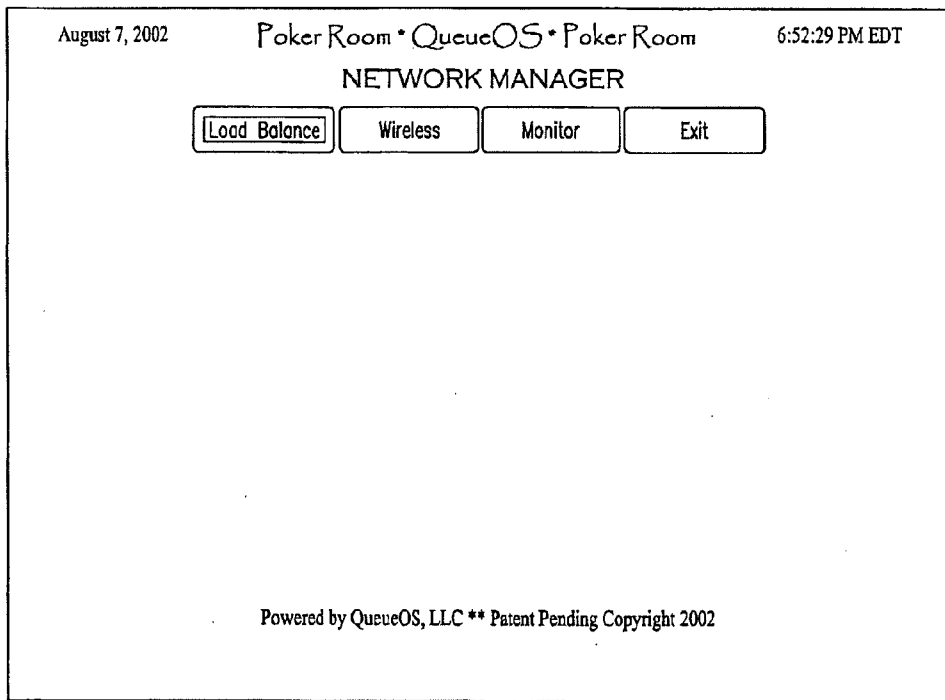

FIG. 9

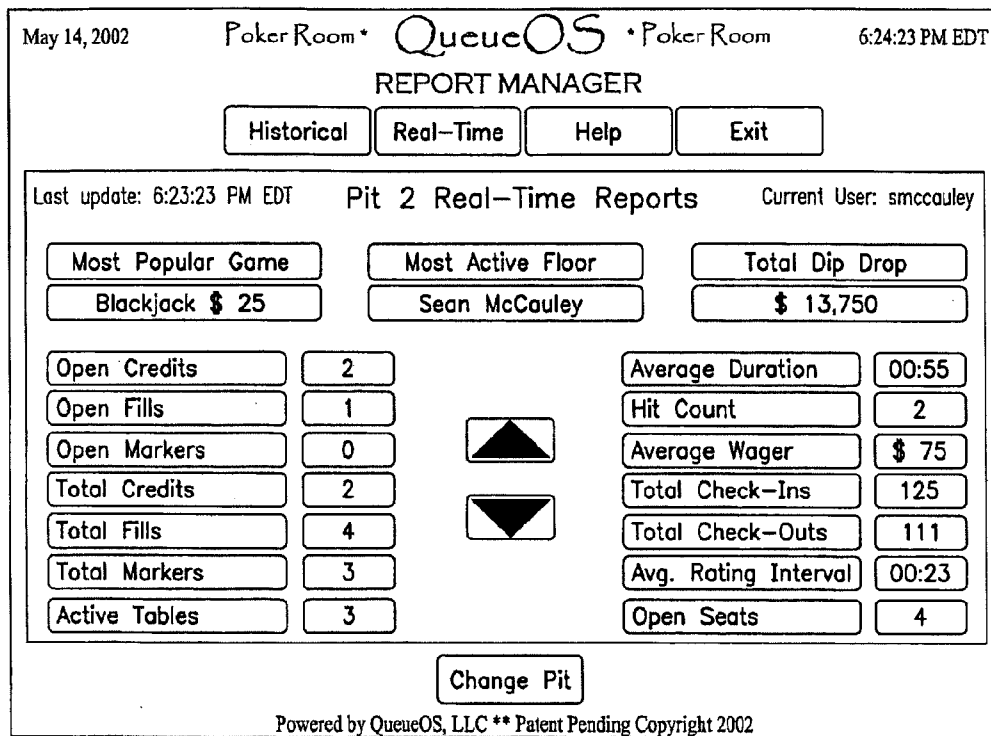

FIG. 10

U.S. Patent

Feb. 1, 2011

Sheet 11 of 95

US 7,878,909 B2

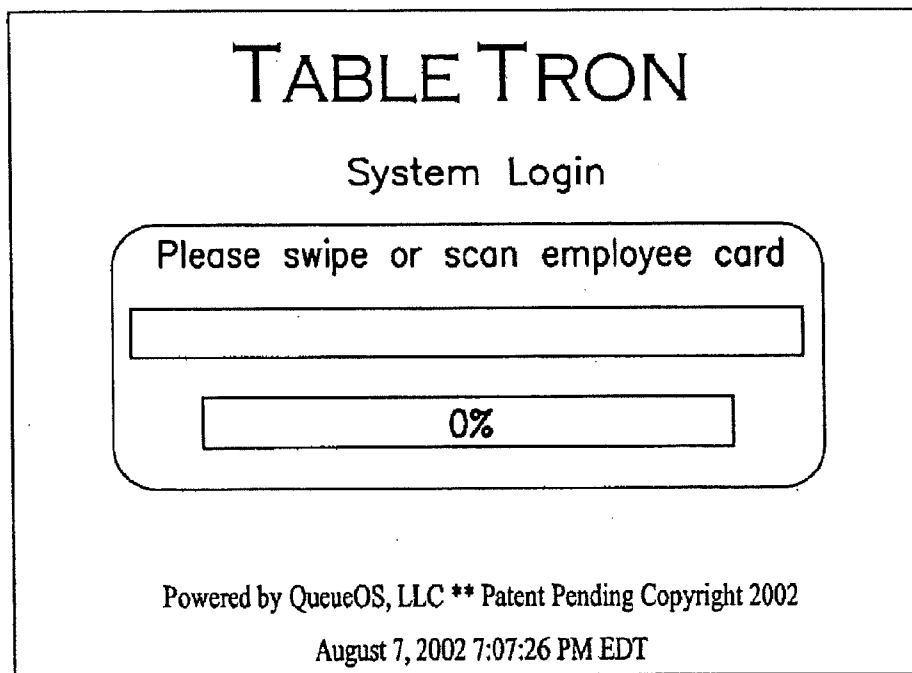

FIG. 11

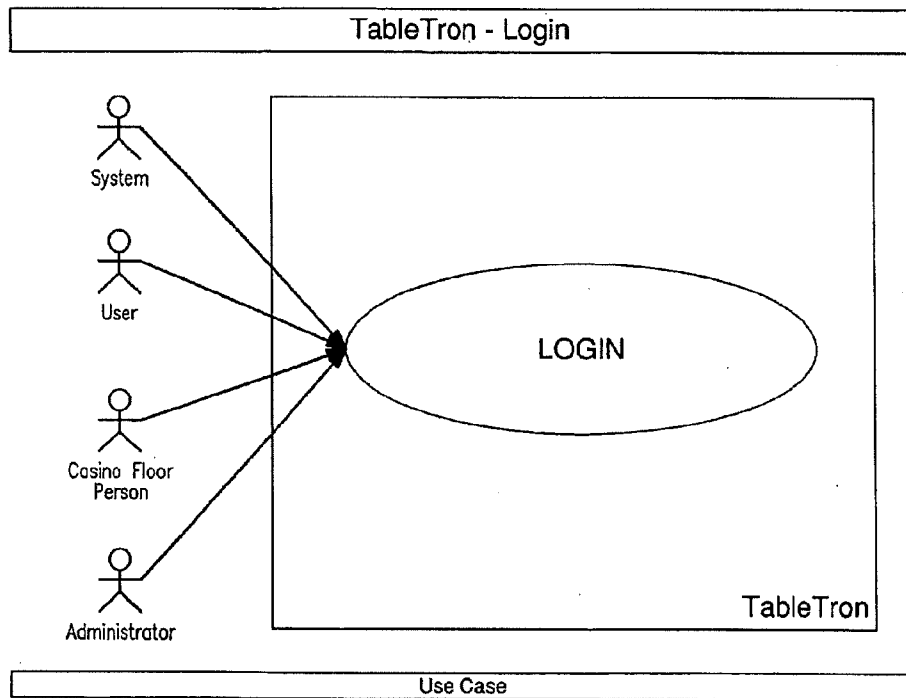

FIG. 12

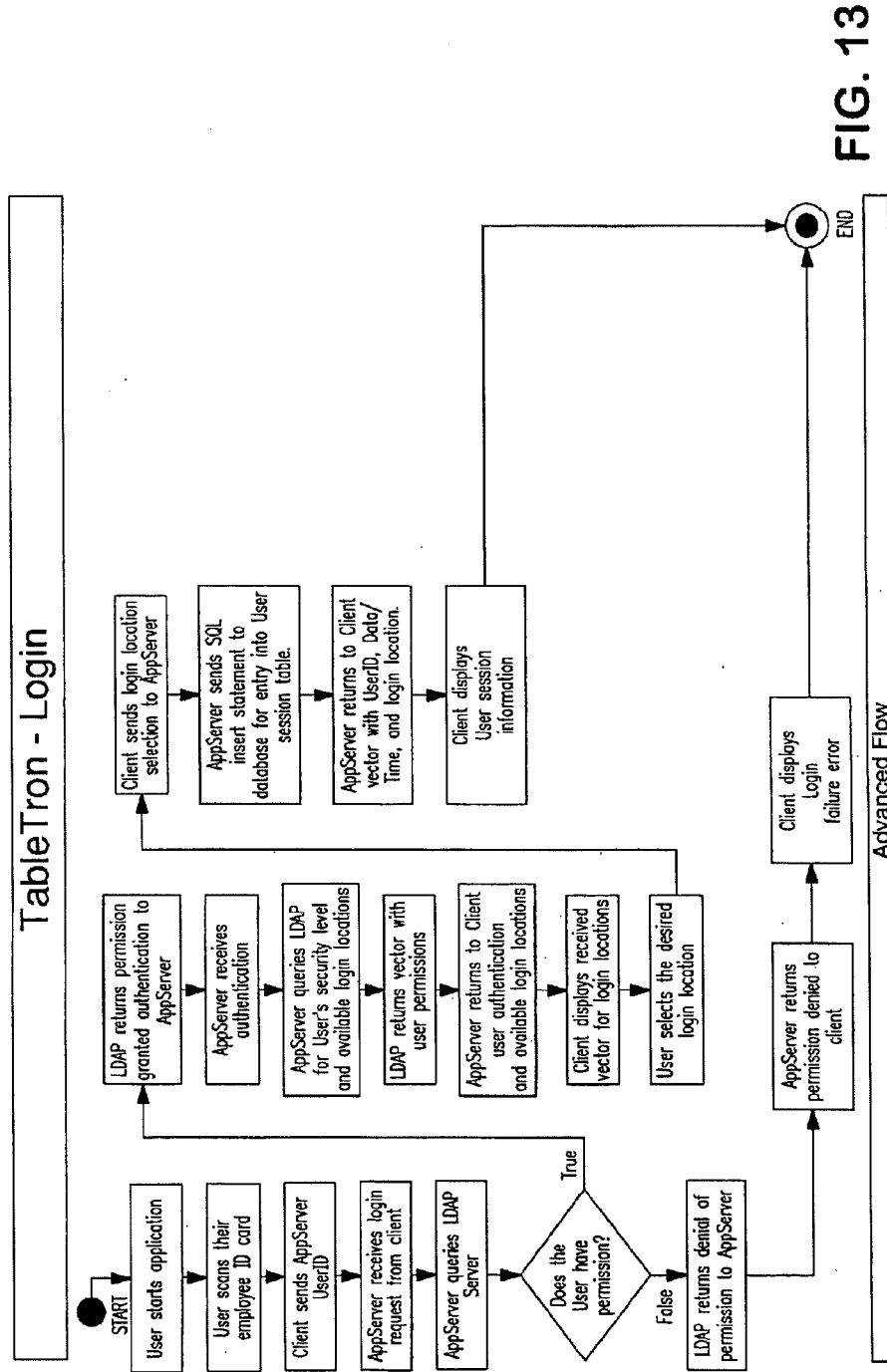

FIG. 13

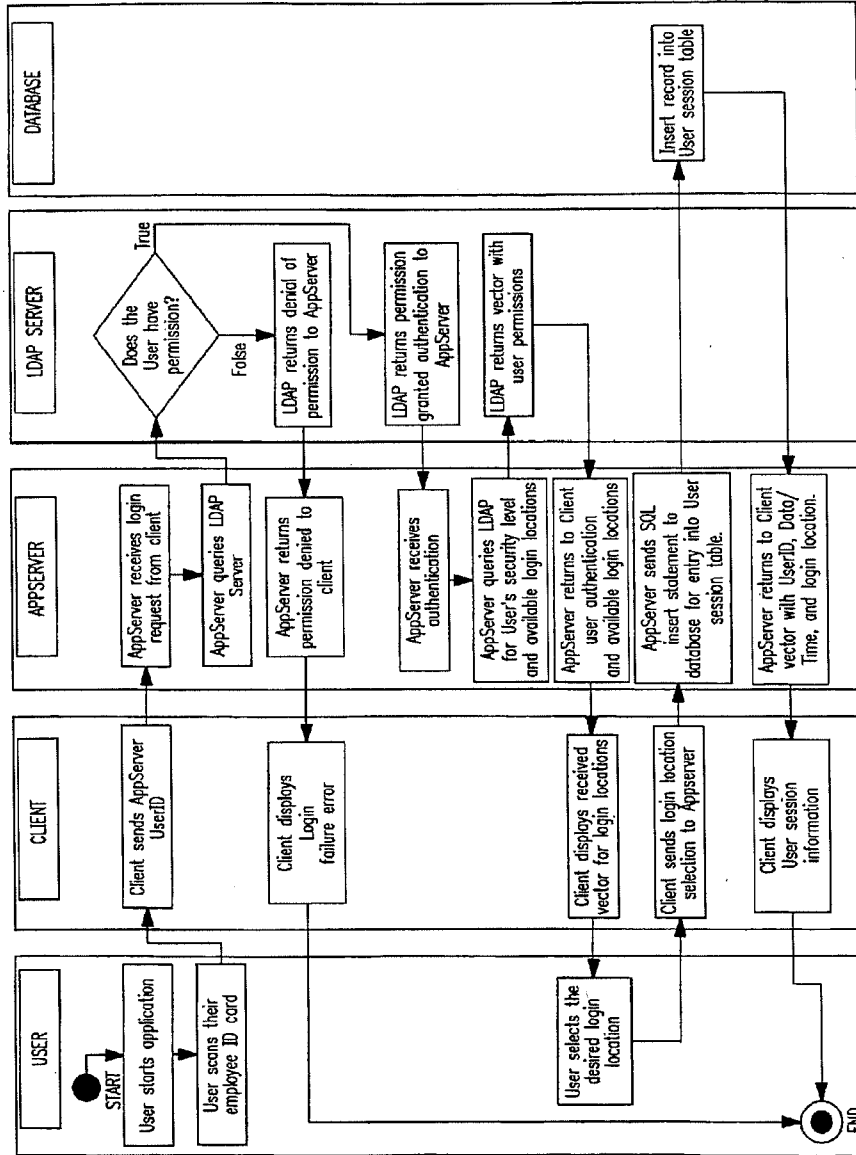

FIG. 14

August 7, 2002	Poker Room * QueueOS * Poker Room	5:58:50 PM EDT																																													
CASINO MANAGER																																															
<input type="button" value="Fill"/> <input type="button" value="Credit"/> <input type="button" value="Marker"/> <input type="button" value="Help"/> <input type="button" value="Exit"/>																																															
Please select a table																																															
<input type="button" value="1"/> <input type="button" value="8"/> <input type="button" value="3"/> <input type="button" value="5"/> <input type="button" value="7"/> <input type="button" value="18"/> <input type="button" value="26"/> <input type="button" value="30"/>																																															
Please select chip denomination and amounts																																															
<table border="1" style="width: 100%; border-collapse: collapse;"> <tr> <td style="width: 20%;">\$0.25</td> <td style="width: 10%;">+</td> <td style="width: 10%;">-</td> <td style="width: 10%;">0</td> <td style="width: 50%;"></td> <td style="width: 10%;">0</td> <td style="width: 10%;">+</td> <td style="width: 10%;">-</td> <td style="width: 10%;">\$5</td> </tr> <tr> <td>\$0.50</td> <td>+</td> <td>-</td> <td>0</td> <td></td> <td>0</td> <td>+</td> <td>-</td> <td>\$25</td> </tr> <tr> <td>\$1</td> <td>+</td> <td>-</td> <td>0</td> <td style="text-align: center;"><input type="button" value="\$8800"/></td> <td>300</td> <td>+</td> <td>-</td> <td>\$100</td> </tr> <tr> <td>\$1T</td> <td>+</td> <td>-</td> <td>0</td> <td></td> <td>3500</td> <td>+</td> <td>-</td> <td>\$500</td> </tr> <tr> <td>\$3</td> <td>+</td> <td>-</td> <td>0</td> <td></td> <td>5000</td> <td>+</td> <td>-</td> <td>\$1000</td> </tr> </table>	\$0.25	+	-	0		0	+	-	\$5	\$0.50	+	-	0		0	+	-	\$25	\$1	+	-	0	<input type="button" value="\$8800"/>	300	+	-	\$100	\$1T	+	-	0		3500	+	-	\$500	\$3	+	-	0		5000	+	-	\$1000	<input type="button" value="Next"/>	
\$0.25	+	-	0		0	+	-	\$5																																							
\$0.50	+	-	0		0	+	-	\$25																																							
\$1	+	-	0	<input type="button" value="\$8800"/>	300	+	-	\$100																																							
\$1T	+	-	0		3500	+	-	\$500																																							
\$3	+	-	0		5000	+	-	\$1000																																							

FIG. 15

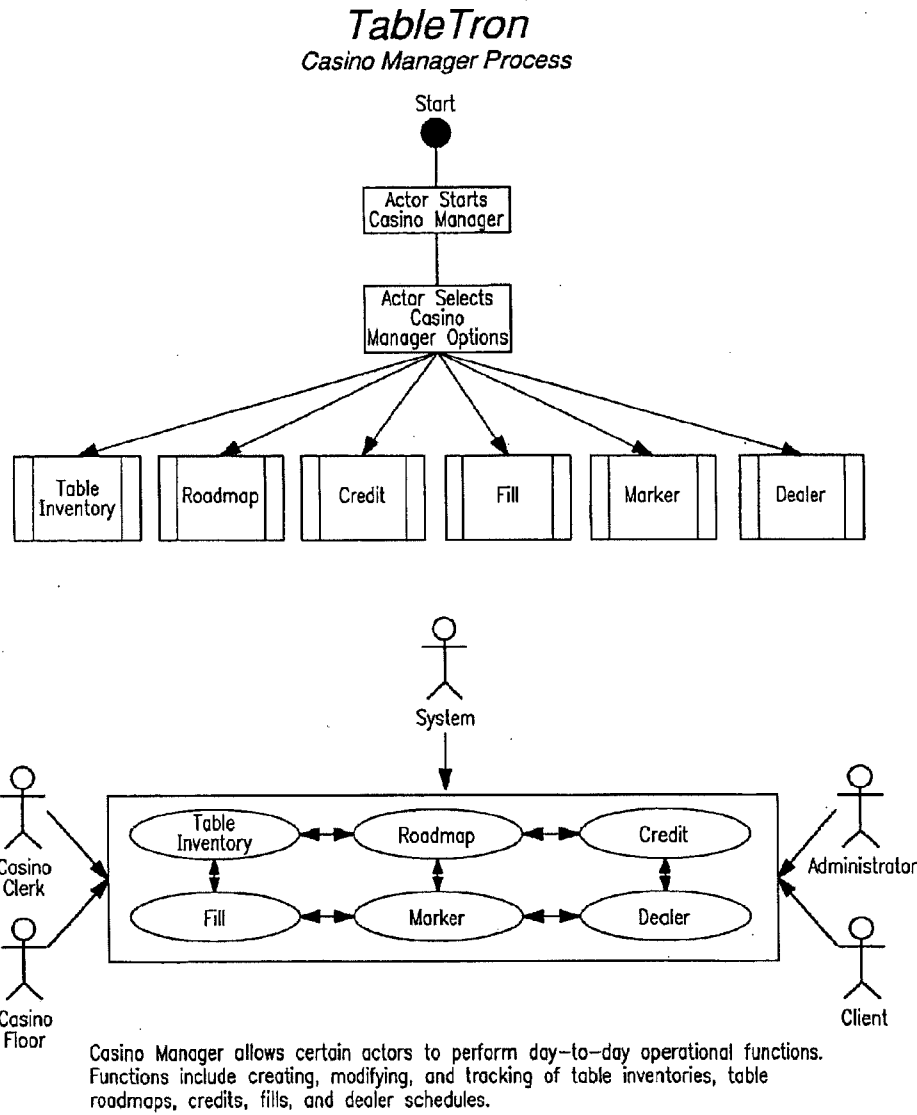

FIG. 16

August 7, 2002 Poker Room * Queue OS * Poker Room 5:28:21 PM EDT

RATING MANAGER

Exit

Please select a table

1	3	5	7	8	18	26	30
---	---	---	---	---	----	----	----

Please select a seat

3	1	5
---	---	---

Player wager

0	X	\$1	+	-	1	X	\$100	+	-	
0	X	\$5	+	-	\$100	0	X	\$500	+	-
0	X	\$25	+	-		0	X	\$100	+	-

Duration: 0 Hours 5 Minutes

Average Bet: 75

Submit

FIG. 17

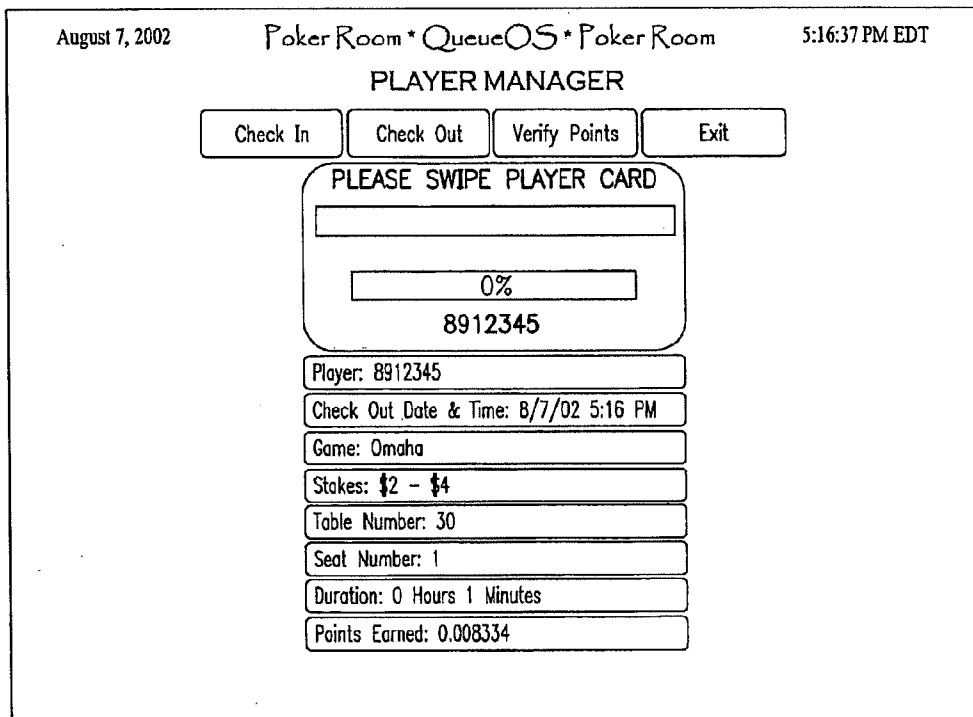

FIG. 18

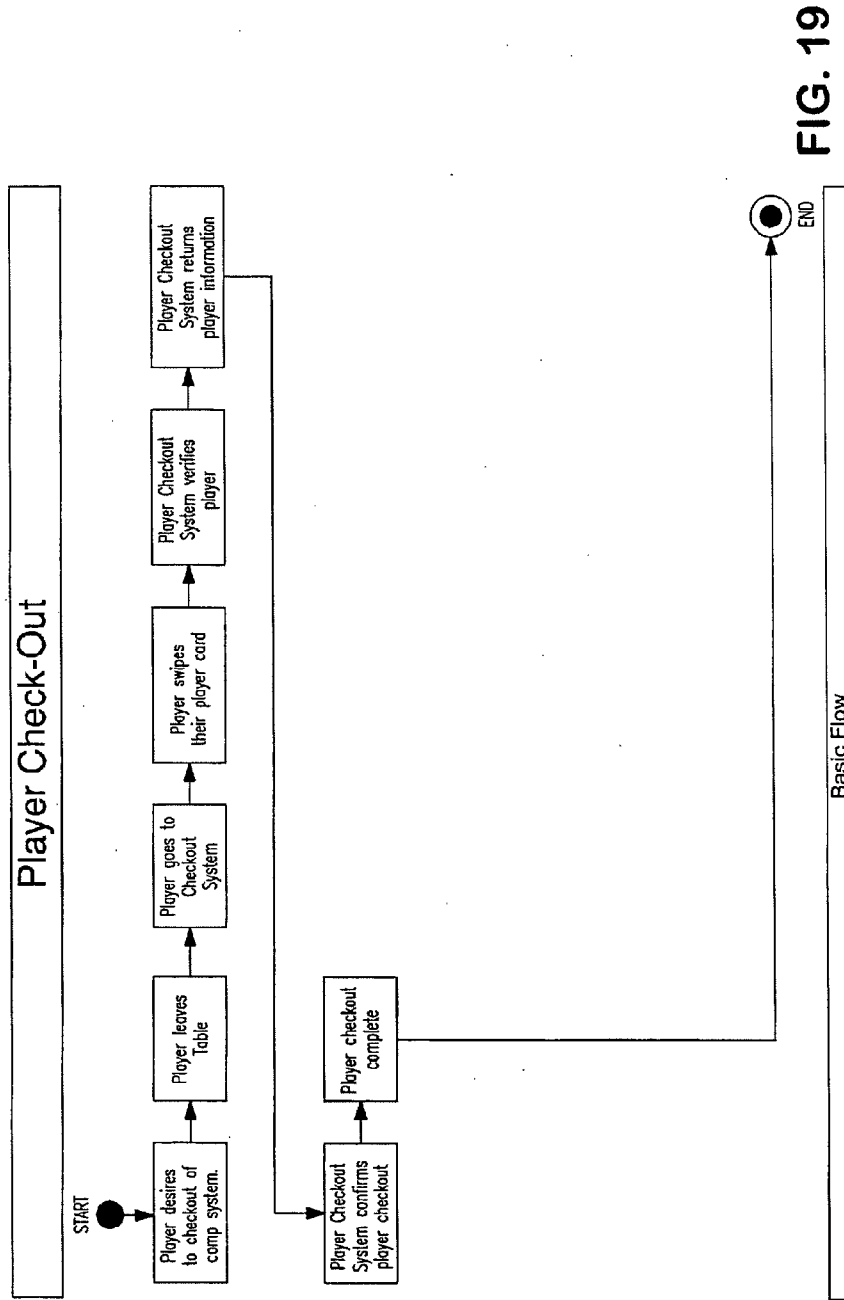
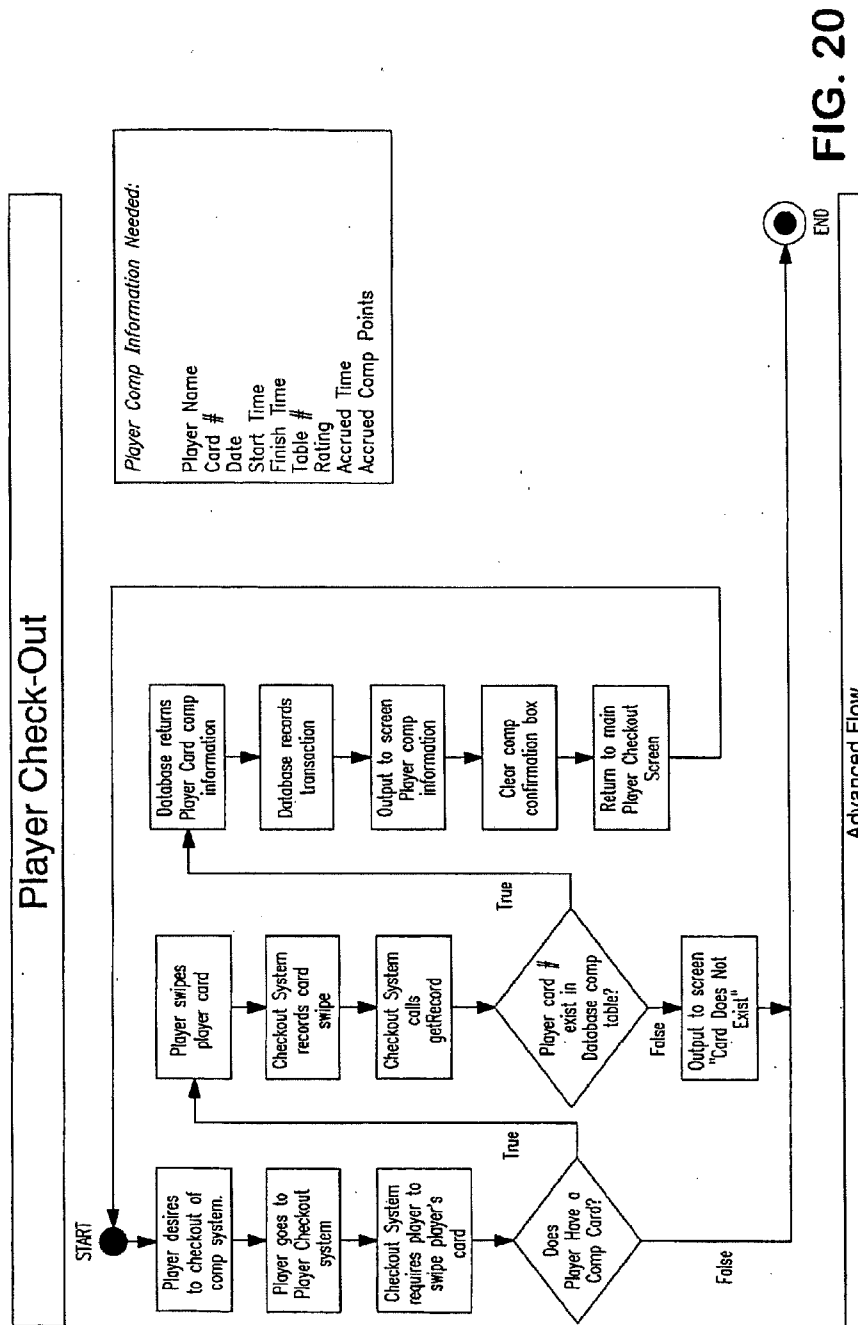

FIG. 19



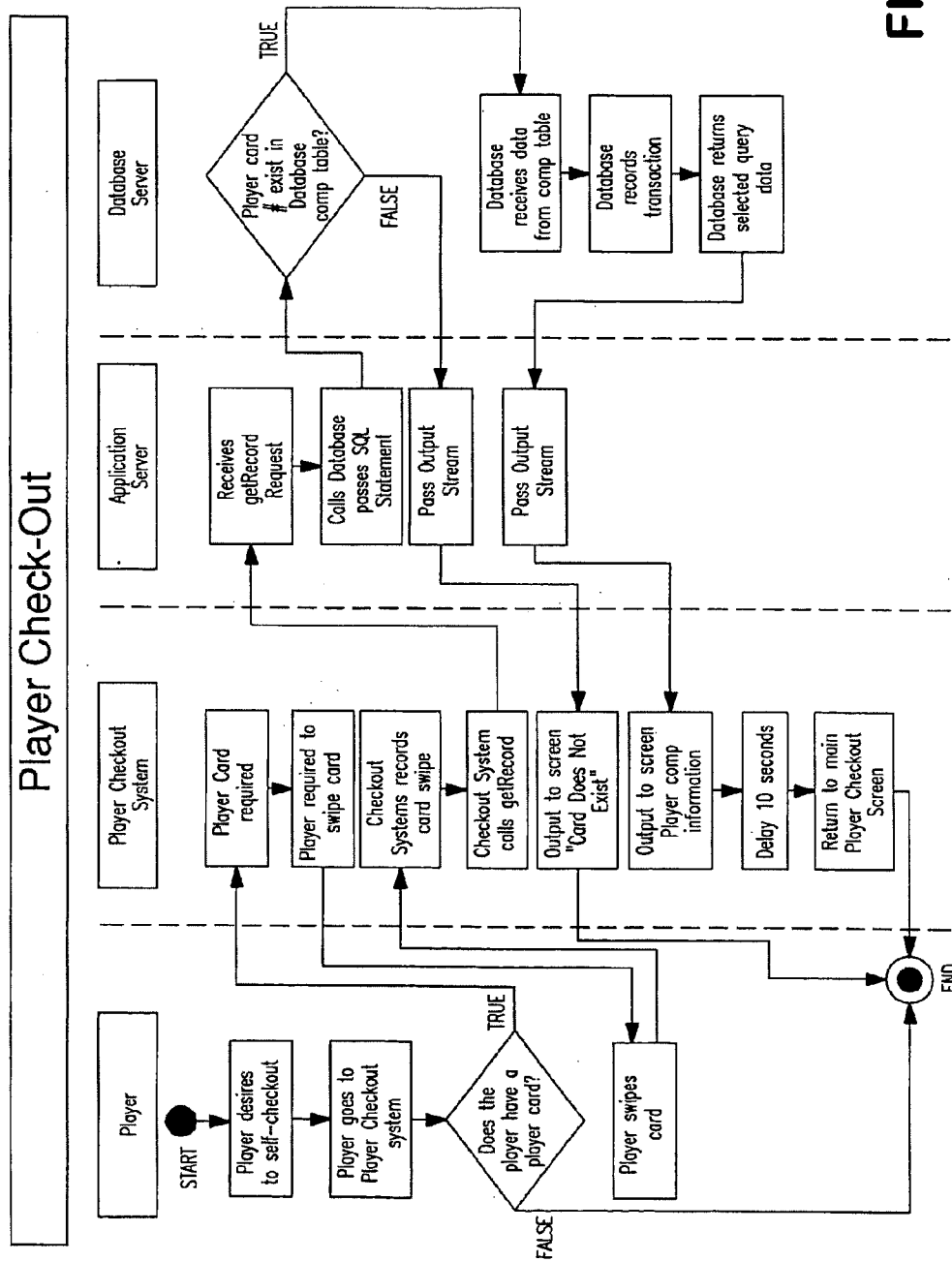

FIG. 21