

1 Todd C. Atkins (CA Bar No. 208879)
tatkings@siprut.com
2 SIPRUT PC
701 B Street, Suite 1170
3 San Diego, CA 92101
619.255.2380
4

5 Joseph J. Siprut (*pro hac vice* pending)
jsiprut@siprut.com
SIPRUT PC
6 17 N. State St., Suite 1600
Chicago, IL 60602
7 312.236.0000

8 Matthew M. Wawrzyn (*pro hac vice* pending)
matt@wawrzynlaw.com

9 Stephen C. Jarvis (*pro hac vice* pending)
stephen@wawrzynlaw.com

10 WAWRZYN LLC
233 S. Wacker Dr., 84th Floor
11 Chicago, IL 60606
312.283.8330

12 *Attorneys for Plaintiff William Grecia*
13

14
15 **UNITED STATES DISTRICT COURT**
16 **NORTHERN DISTRICT OF CALIFORNIA**

17 William Grecia,

18 Plaintiff,

19 v.

20 Apple Inc.,

21 Defendant.
22
23
24
25
26
27
28

CASE NO.

Complaint for Patent Infringement

JURY TRIAL DEMANDED

Parties

1. Plaintiff William Grecia lives in Downingtown, Pennsylvania.
2. Defendant Apple is a corporation organized under the laws of California, with its principal place of business located in Cupertino, California.

Jurisdiction and Venue

3. This action arises under the patent laws of the United States, 35 U.S.C. §§ 101 *et seq.*

4. This Court has subject matter jurisdiction over this action under 28 U.S.C. §§ 1331 and 1338(a).

5. This Court may exercise personal jurisdiction over Apple. Apple conducts continuous and systematic business in California and this District. This patent-infringement claim arises directly from Apple’s continuous and systematic activity in this District. In short, this Court’s exercise of jurisdiction over Apple would be consistent with the California long-arm statute and traditional notions of fair play and substantial justice.

6. Venue is proper in this District pursuant to 28 U.S.C. §§ 1391(b)(1) and 1400(b).

Claim of Patent Infringement

7. On November 11, 2014, United States Patent No. 8,887,308 (the “’308 patent”) was issued to William Grecia for an invention on a process for transforming a user access request into an authorization object. William Grecia owns the ‘308 patent, which is attached hereto as Exhibit A.

8. Apple is infringing the ‘308 patent by practicing the patent’s process. Specifically, the “Apple Pay” service involves all of the steps set forth in the ‘308 patent:

- a. Apple receives “an access request for cloud digital content through an apparatus in process with at least one CPU” when a user sets up an Apple Pay account on her iPhone 6 and 6+. The user enters her “CVV security code,” for example, and thereby requests cloud digital content through her phone in process with the CPU of the phone.

1
2
3
4
5
6
7
8
9
10
11
12
13
14
15
16
17
18
19
20
21
22
23
24
25
26
27
28

- b. Apple authenticates the CVV security code—a verification token—using its iTunes database.
- c. Apple establishes an API communication with databases different from the iTunes database when Apple establishes communications with, for example, the tokenization databases of MasterCard, Visa, and American Express. Establishing these communications requires a credential that is assigned to the user’s iPhone 6 or 6+. The communications between the phone and the tokenization databases are capable of communicating and exchanging query data that comprise a verified web service account identifier.
- d. The CPU of the phone requests from the operating system and related apparatus of the phone the query data that includes the web service identifier.
- e. The CPU of the phone receives this query data from one of the tokenization databases (i.e., MasterCard, Visa, or American Express) when via the API communication the phone receives a virtual credit card number.
- f. Apple creates a computer readable authorization object when the CPU of the phone writes the virtual credit card number to the secure element of the phone. During subsequent user access requests (i.e., subsequent uses of Apple Pay at participating merchants), the phone processes the authorization object using the cross-referencing action of comparing the user’s fingerprint to the print with authorization to use the phone.

9. Apple has contracts with third parties that entitle Apple to 15 cents on every 100 dollars that a consumer spends based on credit extended to the consumer over Apple Pay. Grecia seeks a fair and reasonable royalty that reflects a percentage of these payments

1 to Apple and a percentage of Apple sales of phones that perform the transformation process
2 of the '308 patent.

3 **Prayer for Relief**

4 WHEREFORE, William Grecia prays for the following relief against Apple:

- 5 (a) Judgment that Apple has directly infringed the '308 patent;
6 (b) For a fair and reasonable royalty;
7 (c) For pre-judgment interest and post-judgment interest at the maximum rate
8 allowed by law;
9 (d) For such other and further relief as the Court may deem just and proper.

10 **Demand for Jury Trial**

11 William Grecia demands a trial by jury on all matters and issues triable by jury.

12
13 Date: November 11, 2014

Respectfully submitted,

14 s/ Todd Atkins

15 Todd C. Atkins (CA Bar No. 208879)
16 tatkins@siprut.com
17 SIPRUT PC
18 701 B Street, Suite 1170
19 San Diego, CA 92101
20 619.255.2380

21 Joseph J. Siprut (*pro hac vice* pending)
22 jsiprut@siprut.com
23 SIPRUT PC
24 17 N. State St., Suite 1600
25 Chicago, IL 60602
26 312.236.0000

27 Matthew M. Wawrzyn (*pro hac vice* pending)
28 matt@wawrzynlaw.com
Stephen C. Jarvis (*pro hac vice* pending)
stephen@wawrzynlaw.com
WAWRZYN LLC
233 S. Wacker Dr., 84th Floor
Chicago, IL 60606
312.283.8330

Attorneys for Plaintiff William Grecia

Exhibit A



(12) **United States Patent**
Grecia

(10) **Patent No.:** **US 8,887,308 B2**
(45) **Date of Patent:** ***Nov. 11, 2014**

(54) **DIGITAL CLOUD ACCESS (PDMAS PART III)**

(58) **Field of Classification Search**
None

(71) Applicant: **William Grecia**, Downingtown, PA (US)

See application file for complete search history.

(72) Inventor: **William Grecia**, Downingtown, PA (US)

(56) **References Cited**

(*) Notice: Subject to any disclaimer, the term of this patent is extended or adjusted under 35 U.S.C. 154(b) by 75 days.

U.S. PATENT DOCUMENTS

This patent is subject to a terminal disclaimer.

7,254,235	B2	8/2007	Boudreault et al.	
7,343,014	B2	3/2008	Sovio et al.	
7,526,650	B1*	4/2009	Wimmer	713/176
2005/0065891	A1	3/2005	Lee et al.	
2008/0010685	A1	1/2008	Holtzman et al.	
2009/0083541	A1	3/2009	Levine	
2010/0100899	A1	4/2010	Bradbury et al.	
2011/0288946	A1*	11/2011	Baiya et al.	705/26.1

(21) Appl. No.: **13/888,051**

(22) Filed: **May 6, 2013**

OTHER PUBLICATIONS

(65) **Prior Publication Data**

US 2014/0304778 A1 Oct. 9, 2014

U.S. Appl. No. 13/397,517 Notice of Allowance.
U.S. Appl. No. 13/740,086 Notice of Allowance.

Related U.S. Application Data

* cited by examiner

(63) Continuation of application No. 13/740,086, filed on Jan. 11, 2013, now Pat. No. 8,533,860, which is a continuation of application No. 13/397,517, filed on Feb. 15, 2012, now Pat. No. 8,402,555, which is a continuation of application No. 12/985,351, filed on Jan. 6, 2011, now abandoned, which is a continuation of application No. 12/728,218, filed on Mar. 21, 2010, now abandoned.

Primary Examiner — Jung Kim
Assistant Examiner — Tri Tran

(51) **Int. Cl.**
H04L 29/06 (2006.01)

(57) **ABSTRACT**

(52) **U.S. Cl.**
CPC **H04L 63/10** (2013.01)
USPC **726/29; 726/28; 713/185**

The invention is an apparatus that facilitates access to a data source to accept verification and authentication from an enabler using at least one token and at least one reference. The at least one reference could be a device serial number, a networking MAC address, or a membership ID reference from a web service. Access to the data source is also managed with a plurality of secondary enablers.

1 Claim, 7 Drawing Sheets

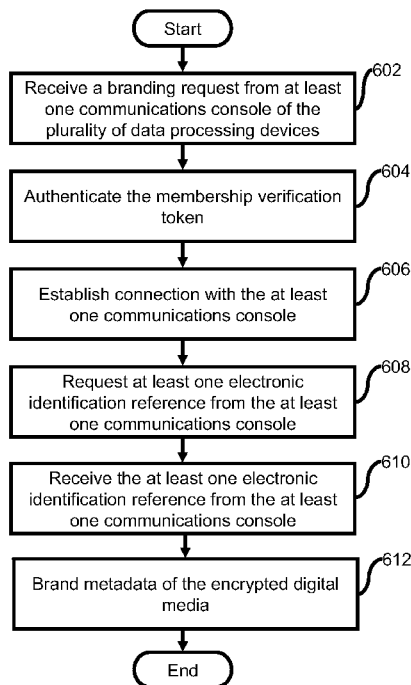

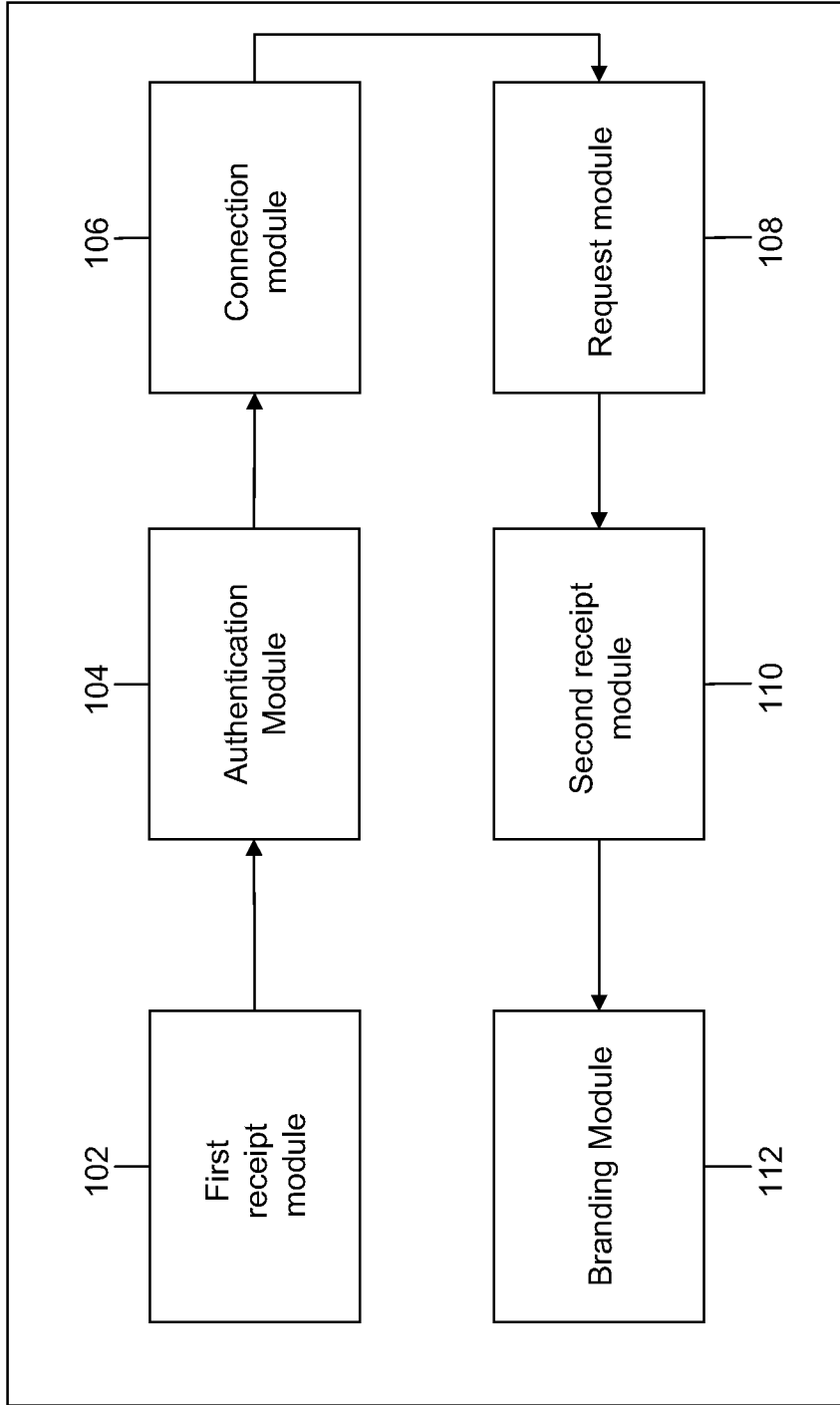

FIG.1

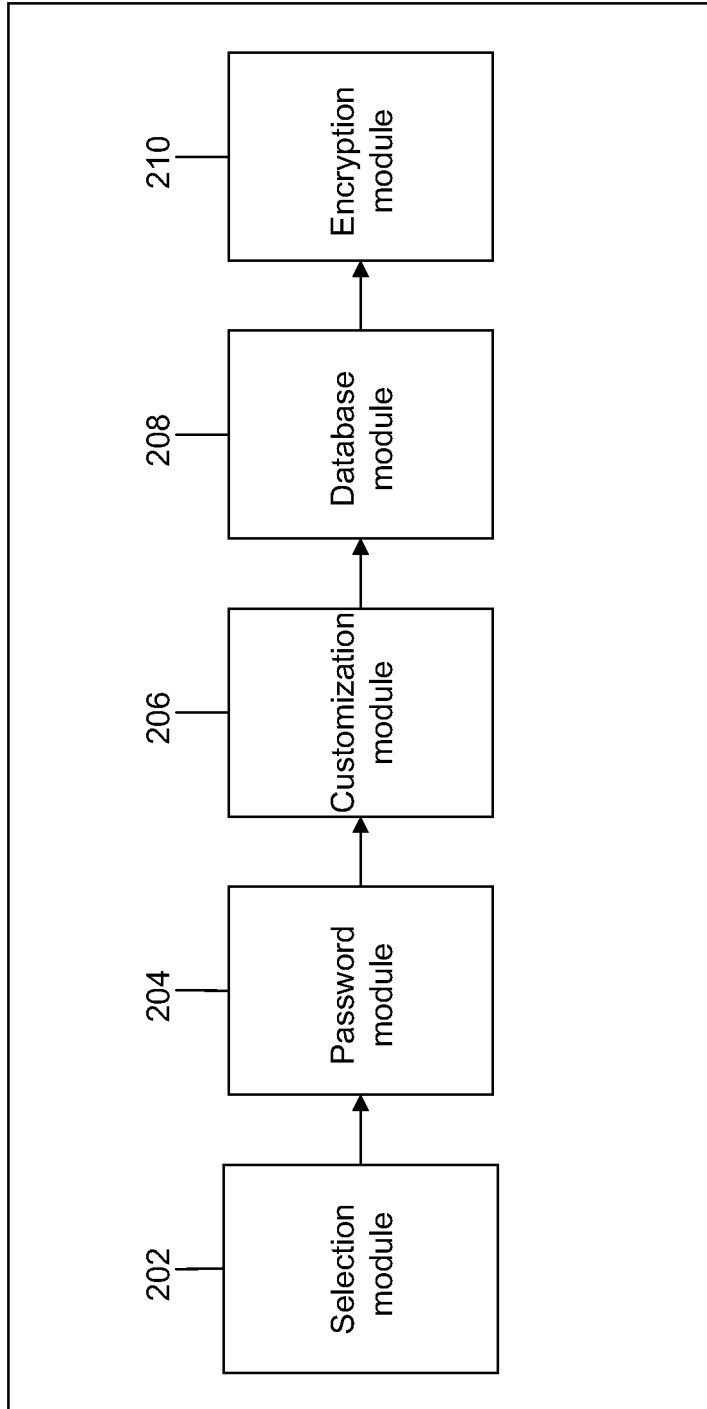

FIG.2

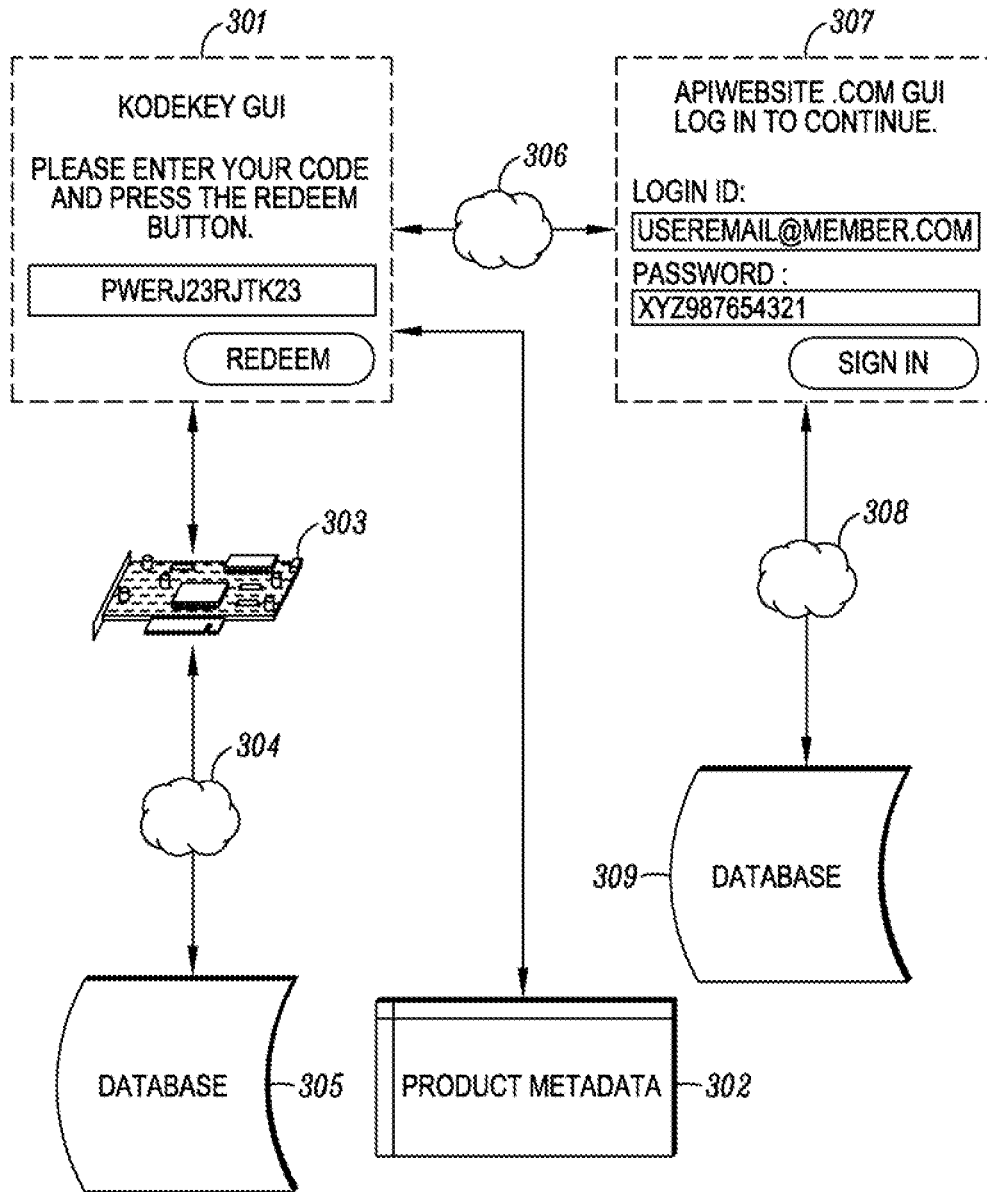

FIG. 3

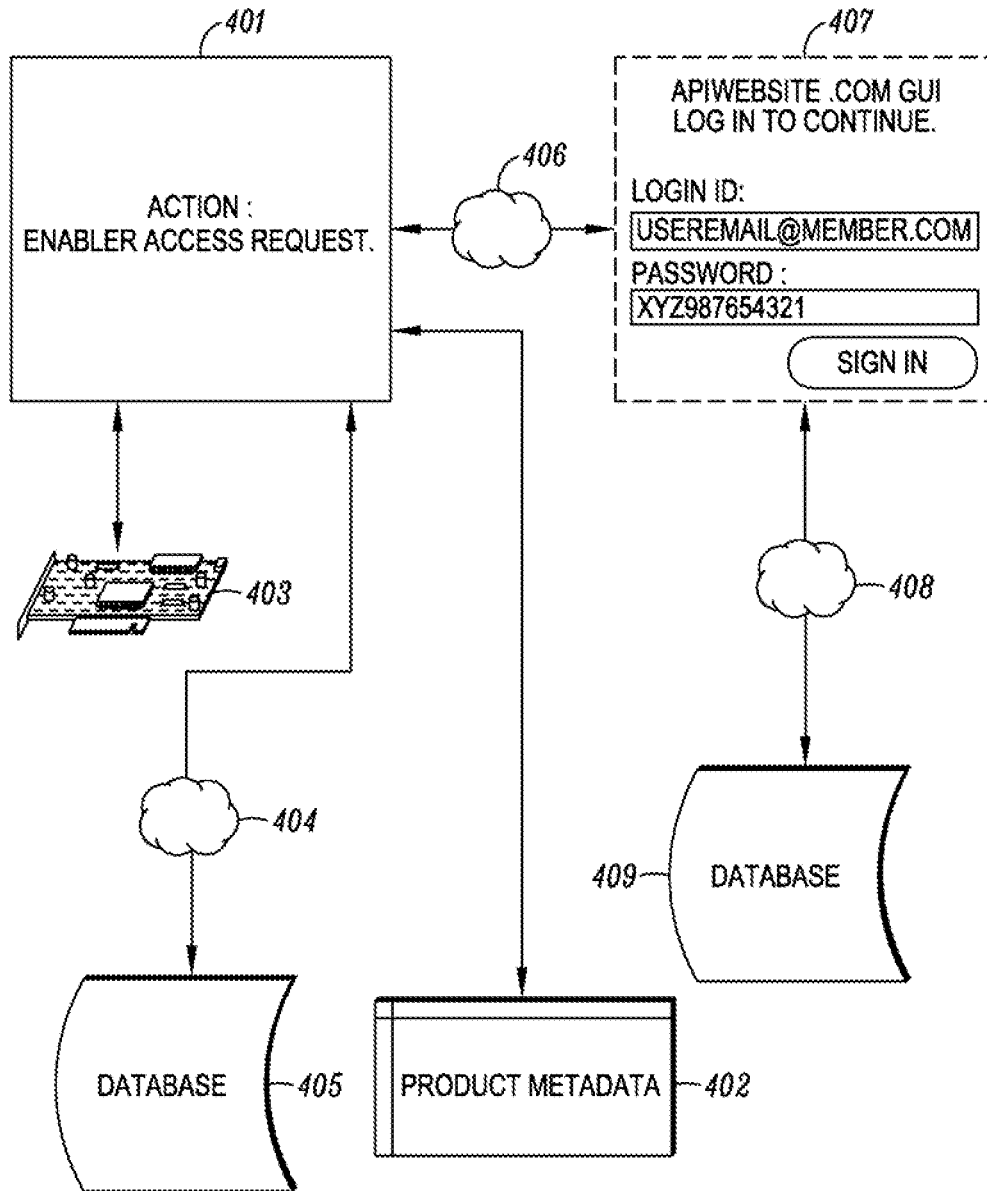

FIG. 4

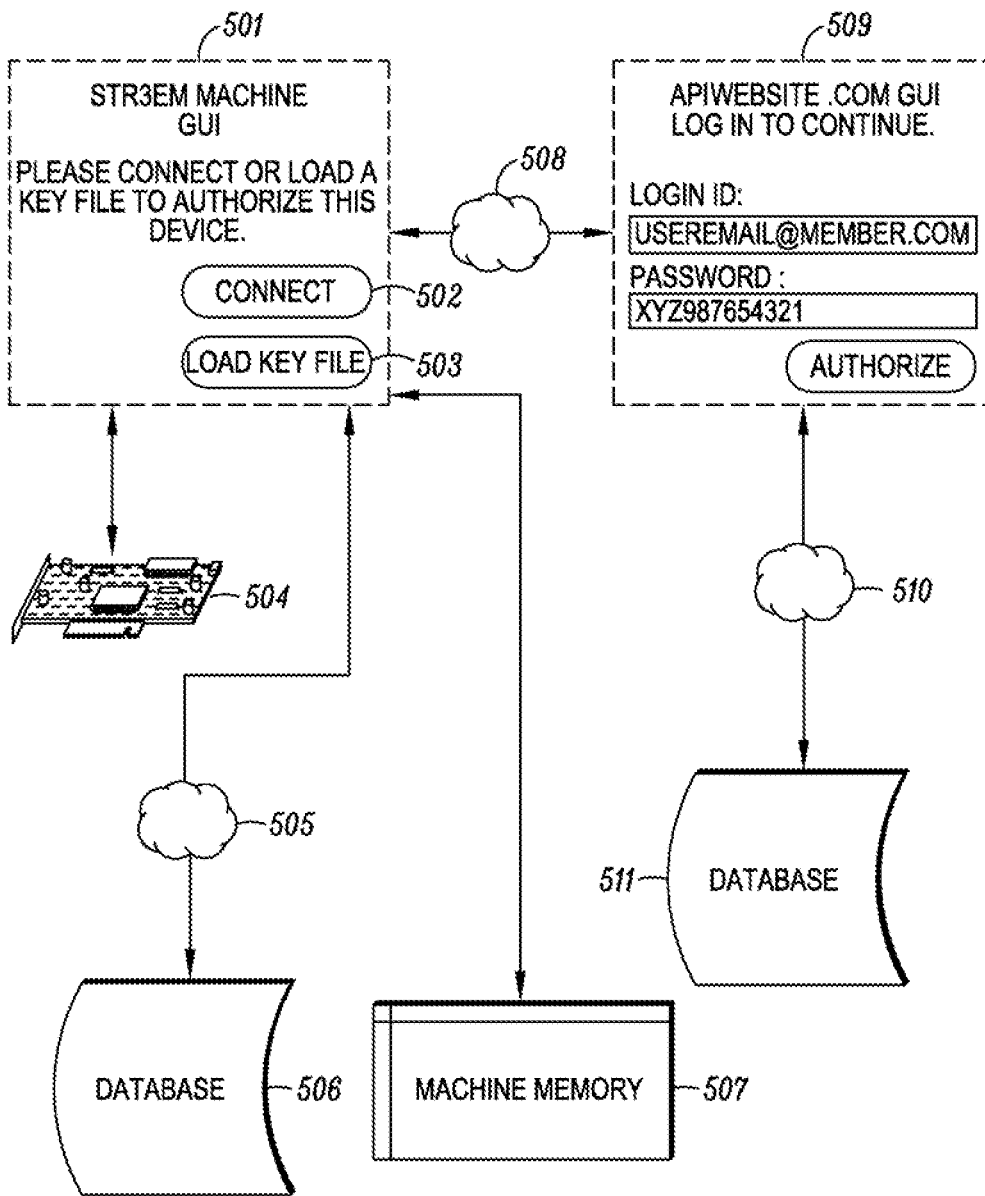

FIG. 5

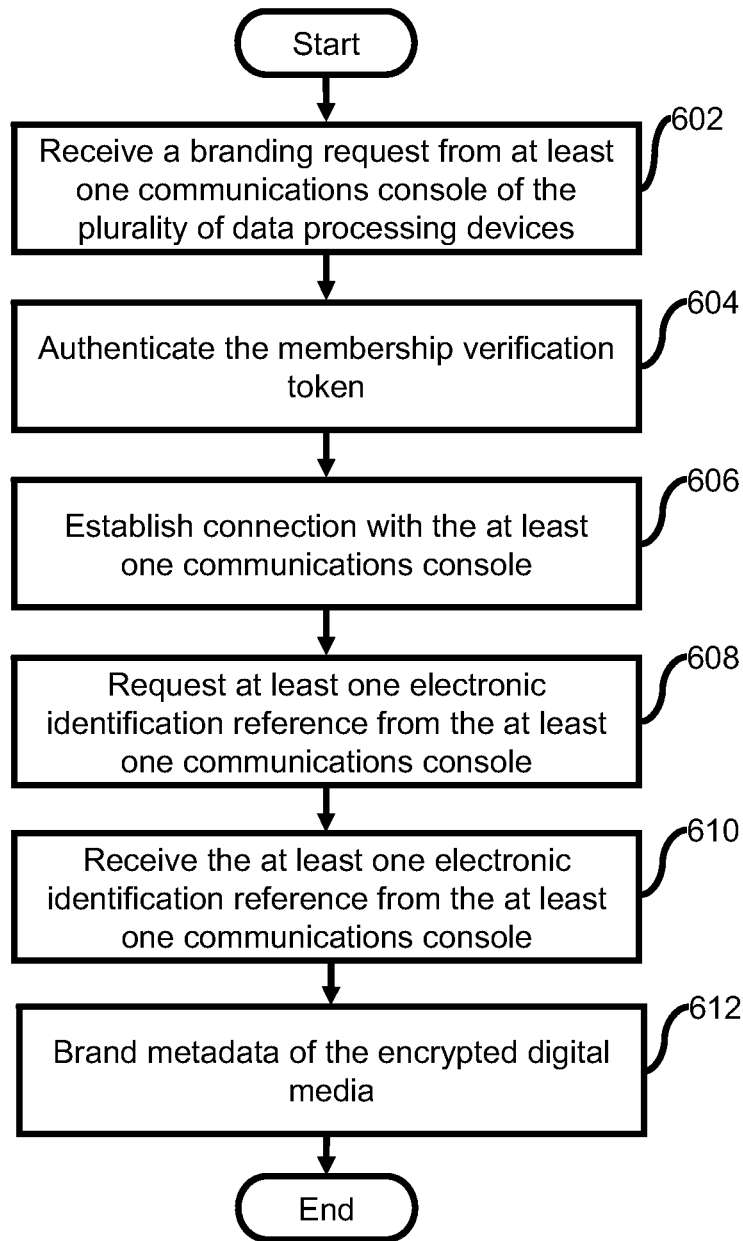

FIG.6

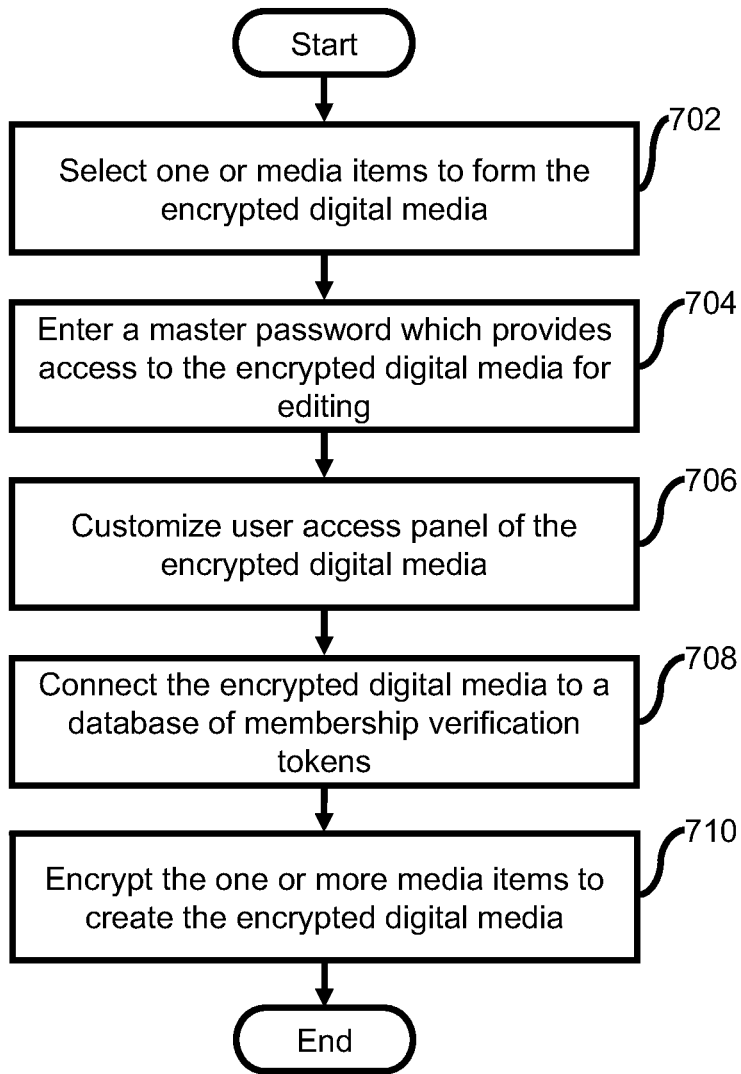

FIG.7

DIGITAL CLOUD ACCESS (PDMAS PART III)

CROSS-REFERENCE TO RELATED APPLICATIONS

This application is a continuation of and claims the priority benefit of U.S. patent application Ser. No. 13/740,086 filed Jan. 11, 2013 which is a continuation of and claims the priority benefit of Ser. No. 13/397,517 filed Feb. 15, 2012 now issued as U.S. Pat. No. 8,402,555 on Mar. 19, 2013 which is a continuation of and claimed the priority benefit of Ser. No. 12/985,351 filed Jan. 6, 2011 which was a continuation of and claimed the priority benefit of U.S. patent application Ser. No. 12/728,218 filed Mar. 21, 2010, which are incorporated herein by reference in their entirety.

BACKGROUND OF THE INVENTION

1. Field of the Invention

The present invention relates to the field of digital rights management schemes used by creators of electronic products to protect commercial intellectual property copyrights privy to illegal copying using computerized devices. More specifically, the present invention teaches a more personal system of digital rights management which employs electronic ID, as part of a web service membership, to manage access rights across a plurality of devices.

2. Description of the Prior Art

Digital rights management (DRM) is a generic term for access control technologies used by hardware manufacturers, publishers, copyright holders and individuals to impose limitations on the usage of digital content across devices. DRM refers to any technology that inhibits undesirable or illegal uses of the digital content. The term generally doesn't refer to forms of copy protection that can be circumvented without modifying the file or device, such as serial numbers or key files. It can also refer to restrictions associated with specific instances of digital works or devices.

Traditional DRM schemes are defined as authentication components added to digital files that have been encrypted from public access. Encryption schemes are not DRM methods but DRM systems are implemented to use an additional layer of authentication in which permission is granted for access to the cipher key required to decrypt files for access. A computer server is established to host decryption keys and to accept authentication keys from Internet connected client computers running client software in which handles the encrypted files. The server can administer different authorization keys back to the client computer that can grant different sets of rules and a time frame granted before the client is required to connect with the server to reauthorize access permissions. In some cases content can terminate access after a set amount of time, or the process can break if the provider of the DRM server ever ceases to offer services.

In the present scenario, consumer entertainment industries are in the transition of delivering products on physical media such as CD and DVD to Internet delivered systems. The Compact Disc, introduced to the public in 1982, was initially designed as a proprietary system offering strict media to player compatibility. As the popularity of home computers and CD-ROM drives rose, so did the availability of CD ripping applications to make local copies of music to be enjoyed without the use of the disc. After a while, users found ways to share digital versions of music in the form of MP3 files that could be easily shared with family and friends over the Internet. The DVD format introduced in 1997 included a new apparatus for optical discs technology with embedded copy

protection schemes also recognized as an early form of DRM. With internet delivered music and video files, DRM schemes has been developed to lock acquired media to specific machines and most times limiting playback rights to a single machine or among a limited number of multiple machines regardless of the model number. This was achieved by writing the machine device ID to the metadata of the media file, then cross referencing with a trusted clearinghouse according to pre-set rules. DRM systems employed by DVD and CD technologies consisted of scrambling (also known as encryption) disc sectors in a pattern to which hardware developed to unscramble (also known as decryption) the disc sectors are required for playback. DRM systems built into operating systems such as Microsoft Windows Vista block viewing of media when an unsigned software application is running to prevent unauthorized copying of a media asset during playback. DRM used in computer games such as SecuROM and Steam are used to limit the amount of times a user can install a game on a machine. DRM schemes for e-books include embedding credit card information and other personal information inside the metadata area of a delivered file format and restricting the compatibility of the file with a limited number of reader devices and computer applications.

In a typical DRM system, a product is encrypted using Symmetric block ciphers such as DES and AES to provide high levels of security. Ciphers known as asymmetric or public key/private key systems are used to manage access to encrypted products. In asymmetric systems the key used to encrypt a product is not the same as that used to decrypt it. If a product has been encrypted using one key of a pair it cannot be decrypted even by someone else who has that key. Only the matching key of the pair can be used for decryption. After receiving an authorization token from a first-use action are usually triggers to decrypt block ciphers in most DRM systems. User rights and restrictions are established during this first-use action with the corresponding hosting device of a DRM protected product.

Examples of such prior DRM art include Hurtado (U.S. Pat. No. 6,611,812) who described a digital rights management system, where upon request to access digital content, encryption and decryption keys are exchanged and managed via an authenticity clearing house. Other examples include Alve (U.S. Pat. No. 7,568,111) who teaches a DRM and Tuoriniemi (U.S. Pat. No. 20090164776) who described a management scheme to control access to electronic content by recording use across a plurality of trustworthy devices that has been granted permission to work within the scheme.

Recently, DRM schemes have proven unpopular with consumers and rights organizations that oppose the complications with compatibility across machines manufactured by different companies. Reasons given to DRM opposition range from limited device playback restrictions to the loss of fair-use which defines the freedom to share media products will family members.

Prior art DRM methods rely on content providers to maintain computer servers to receive and send session authorization keys to client computers with an Internet connection. Usually rights are given from the server for an amount of time or amount of access actions before a requirement to reconnect with the server is required for reauthorization. At times, content providers will discontinue servers or even go out of business some years after DRM encrypted content was sold to consumers causing the ability to access files to terminate.

In the light of the foregoing discussion, the current states of DRM measures are not satisfactory because unavoidable issues can arise such as hardware failure or property theft that could lead to a paying customer loosing the right to recover

US 8,887,308 B2

3

purchased products. The current metadata writable DRM measures do not offer a way to provide unlimited interoperability between different machines. Therefore, a solution is needed to give consumers the unlimited interoperability between devices and “fair use” sharing partners for an infinite time frame while protecting commercial digital media from unlicensed distribution to sustain long-term return of investments.

SUMMARY OF THE INVENTION

An object of the present invention is to provide unlimited interoperability of digital media between unlimited machines with management of end-user access to the digital media.

In accordance with an embodiment of the present invention, the invention is a process of an apparatus which in accordance with an embodiment, another apparatus, tangible computer medium, or associated methods (herein referred to as The App) is used to: handle at least one branding action which could include post read and write requests of at least one writable metadata as part of at least one digital media asset to identify and manage requests from at least one excelsior enabler, and can further identify and manage requests from a plurality of connected second enablers; with at least one token and at least one electronic identification reference received from the at least one excelsior enabler utilizing at least one membership. Here, controlled by the at least one excelsior enabler, The App will proceed to receive the at least one token to verify the authenticity of the branding action and further requests; then establish at least one connection with at least one programmable communications console of the at least one membership to request and receive the at least one electronic identification reference; and could request and receive other data information from the at least one membership. The method then involves sending and receiving variable data information from The App to the at least one membership to verify a preexisting the at least one branding action of the at least one writable metadata as part of the at least one digital media asset; or to establish permission or denial to execute the at least one branding action or the post read and write requests of the at least one writable metadata. To do this, controlled by the at least one excelsior enabler. The App may establish at least one connection, which is usually through the Internet, with a programmable communications console, which is usually a combination of an API protocol and graphic user interface (GUI) as part of a web service. In addition, the at least one excelsior enabler provides reestablished credentials to the programmable communications console as part of the at least one membership, in which The App is facilitating and monitoring, to authenticate the data communications session used to send and receive data requests between the at least one membership and The App.

In accordance with another embodiment of the present invention, the present invention teaches a method for monitoring access to an encrypted digital media and facilitating unlimited interoperability between a plurality of data processing devices. The method comprises receiving a branding request from at least one communications console of the plurality of data processing devices, the branding request being a read and write request of metadata of the encrypted digital media, the request comprising a membership verification token corresponding to the encrypted digital media. Subsequently, the membership verification token is authenticated, the authentication being performed in connection with a token database. Thereafter, connection with the at least one communications console is established. Afterwards, at least one electronic identification reference is requested from the at

4

least one communications console. Further, the at least one electronic identification reference is received from the at least one communications console. Finally, branding metadata of the encrypted digital media is performed by writing the membership verification token and the electronic identification reference into the metadata.

The present invention is particularly useful for giving users the freedom to use products outside of the device in which the product was acquired and extend unlimited interoperability with other compatible devices.

BRIEF DESCRIPTION OF THE DRAWINGS

For a more complete understanding of the present invention, the needs satisfied thereby, and the objects, features, and advantages thereof, reference now is made to the following description taken in connection with the accompanying drawings.

FIG. 1 shows a system for monitoring access to an encrypted digital media according to an embodiment of the present invention.

FIG. 2 shows a system for authoring an encrypted digital media according to an embodiment of the present invention.

FIG. 3 shows a flow chart giving an overview of the process of digital media personalization according to an embodiment of the present invention.

FIG. 4 shows a flow chart giving an overview of the process of an access request made by an enabler according to an embodiment of the present invention.

FIG. 5 shows personalized digital rights management component as part of a compatible machine with writable static memory.

FIG. 6 shows a flowchart for monitoring access to an encrypted digital media according to an embodiment of the present invention

FIG. 7 shows a flowchart showing authoring an encrypted digital media according to an embodiment of the present invention.

Skilled artisans will appreciate that elements in the figures are illustrated for simplicity and clarity and have not necessarily been drawn to scale. For example, the dimensions of some of the elements in the figures may be exaggerated relative to other elements to help to improve understanding of embodiments of the present invention

DETAILED DESCRIPTION OF THE DRAWINGS

Before describing in detail the particular system and method for personalised digital media access system in accordance with an embodiment of the present invention, it should be observed that the present invention resides primarily in combinations of system components related to the device of the present invention.

Accordingly, the system components have been represented where appropriate by conventional symbols in the drawings, showing only those specific details that are pertinent to understanding the present invention so as not to obscure the disclosure with details that will be readily apparent to those of ordinary skill in the art having the benefit of the description herein.

In this document, relational terms such as ‘first’ and ‘second’, and the like may be used solely to distinguish one entity or action from another entity or action without necessarily requiring or implying any actual such relationship or order between such entities or actions. The terms ‘comprises’, ‘comprising’, or any other variation thereof, are intended to cover a non-exclusive inclusion, such that a process, method,

US 8,887,308 B2

5

article, or apparatus that comprises a list of elements does not include only those elements but may include other elements not expressly listed or inherent to such process, method, article, or apparatus. An element preceded by 'comprises . . . a' does not, without more constraints, preclude the existence of additional identical elements in the process, method, article, or apparatus that comprises the element.

The present invention is directed at providing infinite access rights of legally acquired at least one encrypted digital media asset to the content acquirer, explained in this document as the excelsior enabler, and optionally to their recognized friends and family, explained in this document as a plurality of secondary enablers. To explain further, the excelsior enabler and secondary enablers defined comprises human beings or computerized mechanisms programmed to process steps of the invention as would normally be done manually by a human being. Additionally, an apparatus used alone or in accordance with an embodiment, another apparatus, tangible computer medium, or associated methods with a connection are needed (herein referred to as The App). To deliver the requirements of the invention, communicative and connected elements comprise: verification, authentication, electronic ID metadata branding, additional technical branding, and cross-referencing. The connection handling the communicative actions of the invention will usually be the Internet and can also be an internal apparatus cooperative. The App can further be defined as a Windows OS, Apple OS, Linux OS, and other operating systems hosting software running on a machine or device with a capable CPU, memory, and data storage. The App can be even further defined as a system on a chip (SOC), embedded silicon, flash memory, programmable circuits, cloud computing and runtimes, and other systems of automated processes.

The digital media assets used in this system are encrypted usually with an AES cipher and decryption keys are usually stored encoded, no encoded, encrypted, or no encrypted as part of the apparatus or as part of a connection usually an Internet server. As explained earlier, the system we will discuss will work as a front-end to encrypted files as an authorization agent for decrypted access.

FIG. 1 shows a system **100** for monitoring access to an encrypted digital media according to an embodiment of the present invention. The system **100** includes a first recipient module **102**, an authentication module **104**, a connection module **106**, a request module **108**, a second receipt module **110** and a branding module **112**. The first receipt module **102** receives a branding request from at least one communications console of the plurality of data processing devices. The branding request is a read and write request of metadata of the encrypted digital media and includes a membership verification token corresponding to the encrypted digital media. Examples of the encrypted digital media includes, and are not limited to, one or more of a video file, audio file, container format, document, metadata as part of video game software and other computer based apparatus in which processed data is facilitated.

Subsequently, the authentication module **104** authenticates the membership verification token. The authentication is performed in connection with a token database. Further, the connection module **106** establishes communication with the at least one communication console.

According to an embodiment of the present invention, the connection is established through one of internet, intranet, Bluetooth, VPN, Infrared and LAN.

According to another embodiment of the present invention, the communication console is a combination of an Application Programmable interface (API) protocol and graphic user

6

interface (GUI) as a part of web service. The API is a set of routines, data structures, object classes, and/or protocols provided by libraries and/or operating system services. The API is either one of language dependent or language independent.

The request module **108** requests at least one electronic identification reference from the at least one communication console. The second receipt module **110** receives the at least one electronic identification reference from the least one communication console. The branding module **112** brands metadata of the encrypted digital media by writing the membership verification token and the electronic identification into the metadata.

FIG. 2 shows a system **200** for authoring an encrypted digital media according to an embodiment of the present invention. The figure includes a selection module **202**, a password module **204**, a customization module **206**, a database module **208** and an encryption module **210**. The selection module **202** facilitates selection of one or more media items to form the encrypted digital media. Examples of the one or more media items include, and are not limited to, one or more of a video, an audio and a game.

According to an embodiment of the present invention, the one or more media items are one or more of remote URL links and local media files.

The password module **204** prompts the user to enter a master password which provides access to the encrypted digital media. Subsequently, the customization module **206** allows the user to customize the user access panel of the encrypted digital media.

According to an embodiment of the present invention, the customization module **206** facilitates adding one or more of a banner, a logo, an image, an advertisement, a tag line, a header message and textual information to the user access panel of the encrypted digital media.

Further, the database module **208** connects the encrypted digital media to a database of membership verification token required for decrypting the encrypted digital media.

According to an embodiment of the present invention, the membership verification token is a kodekey. The kodekey is a unique serial number assigned to the encrypted digital media.

The encryption module **210** encrypts the one or more media items to create the encrypted digital media.

According to an embodiment of the present invention, the system **200** further includes a watermark module. The watermark module watermarks information on the encrypted digital media, wherein the watermark is displayed during playback of the encrypted digital media.

According to another embodiment of the present invention, the system **200** further includes an access module. The access module allows the user to define access rights. Examples of the access rights include, but are not limited to, purchasing rights, rental rights and membership access rights.

According to yet another embodiment of the present invention, the system **200** further includes a name module. The name module allows the user to name the encrypted digital media.

FIG. 3 shows a flow chart giving an overview of the process of digital media personalization according to an embodiment of the present invention. The process is achieved by way of an enabler using an apparatus or otherwise known as an application in which facilitates digital media files. The apparatus interacts with all communicative parts required to fulfill the actions of the invention. The figure shows a Kodekey Graphical User Interface (GUI) **301**, a product metadata **302**, a networking card **303**, internet **304**, **306** and **308**, database **305** and **309** and an APIwebsite.com GUI **307**. A user posts a branding request via the Kodekey GUI interface **301**. The

US 8,887,308 B2

7

Kodekey GUI interface **301** is the GUI for entering token. The Kodekey GUI interface **301** prompts the user to enter the token and press the redeem button present on the Kodekey GUI interface **301**. The product metadata **302** is read/writable metadata associated with the digital media to be acquired. The networking card **303** facilitates querying of optional metadata branding process and referenced. The Kodekey GUI interface is connected to the database **305** via the internet **304** through the networking card **303**. The database **305** is the database used to read/write and store the tokens, also referred to as token database. The user is redirected to the APIwebsite.com GUI **307** through the internet **306**. The APIwebsite.com is the GUI to the membership API in which the electronic ID is collected and sent back to the Kodekey GUI interface **301**. The APIwebsite.com GUI **307** prompts the user to enter a login id and a password to access the digital media which is acquired from the database **309** through the internet **308**. The database **309** is the database connected to the web service membership in which the user's electronic ID is queried from.

Examples of the encrypted digital files include, and are not limited to, a video file, an audio file, container formats, documents, metadata as part of video game software and other computer based apparatus in which processed data is facilitated.

FIG. 4 shows a flow chart giving an overview of the process of an access request made by an enabler according to an embodiment of the present invention. Subsequently, the communicative parts to cross-reference information stored in the metadata of the digital media asset are checked which has been previously handled by the process of FIG. 1. The figure shows an enabler access request **401**, a product metadata **402**, a networking card **403**, an internet **404**, **406** and **408**, a database **405** and **409** and an APIwebsite.com GUI **407**. The enabler access request **401** facilitates the user to make a request for the digital media. The product metadata **402** is read/writable metadata associated with the digital media to be acquired. The networking card **403** facilitates querying of optional metadata branding process and referenced. The database **405** is the database used to read/write and store the tokens. The APIwebsite.com GUI **407** is the GUI in which the electronic ID is collected and sent back to the Kodekey GUI interface **301**. The APIwebsite.com GUI **407** prompts the user to enter a login id and a password to access the digital media from the database **409** through the internet **408**. The database **409** is the database connected to the web service membership in which the user's electronic ID is queried from.

FIG. 5 shows personalized digital rights management component as part of a compatible machine with writable static memory. The figure represents an authorization sequence action in which a machine is authorized to accept a personalized digital media file. The figure includes STR3EM Machine GUI **501** including the connect icon **502**, a load key file icon **503**, a networking card **504**, an internet **505**, **508** and **510**, a database **506** and **511**, a machine memory **507** and a APIwebsite.com GUI **509**. The STR3EM Machine GUI **501** prompts the user to connect or load a key file to authorize the device through the connect icon **502** and the load key file icon **503**. The STR3EM Machine GUI **501** is connected to the networking card **504**. The networking card **504** facilitates querying of optional metadata branding process and referenced. Further, the STR3EM machine GUI **501** is connected to the database **506** via the internet **505**. The database **506** is the database used to read/write and store the tokens. Moreover, STR3EM Machine GUI **501** is connected to the machine memory **507**. The machine memory **507** represents the internal memory of the machine or device so authoriza-

8

tions can be saved for access of the digital media. The APIwebsite.com GUI **509** is connected to the STR3EM machine GUI through the internet **508**. Further, APIwebsite.com GUI **509** is connected to the database **511** through the internet **510**. The APIwebsite.com GUI **509** prompts the user to enter the login id and a password to authorize the access to digital media. The database **511** is the database connected to the web service membership in which the user's electronic ID is queried from.

FIG. 6 shows a flowchart for monitoring access to an encrypted digital media according to an embodiment of the present invention. At step **602**, a branding request is made by a user from at least one communications console of the plurality of data processing devices. The branding request is a read and write request of metadata of the encrypted digital media.

According to an embodiment of the present invention, the request includes a membership verification token corresponding to the encrypted digital media.

Subsequently, the membership verification token is authenticated at step **604**. The authentication is performed in connection with a token database. Further, connection with the at least communication console is established at step **606**. Afterwards, at least one electronic identification reference is requested from the at least one communications console at the step **608**. At step **610**, at least one electronic identification reference in received from the at least one communication console. Finally, metadata of the encrypted digital media is branded by writing the membership verification token and the electronic identification reference into the metadata at the step **612**.

FIG. 7 shows a flowchart showing authoring an encrypted digital media according to an embodiment of the present invention. At step **702**, one or more media items are selected by the user to form the encrypted digital media. Subsequently, a master password is entered for providing access to the encrypted digital media for editing at step **704**. Afterwards, the user customizes the user panel of the encrypted digital media at step **706**. Further, the encrypted digital media is connected to a database of membership verification tokens required for decrypting the encrypted digital media at the step **708**. Finally, the one or more media items are encrypted to create the encrypted digital media at the step **710**.

According to various embodiments of the present invention, the verification is facilitated by at least one token handled by at least one excelsior enabler. Examples of the token include, and are not limited to, a structured or random password, e-mail address associated with an e-commerce payment system used to make an authorization payment, or other redeemable instruments of trade for access rights of digital media. Examples of e-commerce systems are PayPal, Amazon Payments, and other credit card services.

According to an embodiment of the present invention, an identifier for the digital media is stored in a database with another database of a list of associated tokens for cross-reference identification for verification.

According to an embodiment of the present invention, the database of a list of associated tokens includes Instant Payment Notification (IPN) received from successful financial e-commerce transactions that includes the identifier for the digital media; import of CSV password lists, and manually created reference phrases.

For this discussion, the structured or random password example will be used as reference. The structured or random passwords can be devised in encoded schemes to flag the apparatus of permission type such as: 1) Purchases can start a password sequence with "P" following a random number, so

US 8,887,308 B2

9

further example would be “PSJD42349MFJDF”. 2) Rentals can start or end a password sequence with “R” plus (+) the number of days a rental is allowed, for example “R7” included in “R7SJDHFG58473” flagging a seven day rental. 3) Memberships can start or end a password sequence with “M” plus (+) optionally the length of months valid for example “M11DFJGH34KF” would flag an eleven-month membership period.

According to an embodiment of the present invention, the tokens are stored in a relational database such as MySQL or Oracle. Cloud storage systems such as Amazon’s Web Services Simple Storage Solution, or also known as S3, provides a highly available worldwide replicated infrastructure. In addition to S3, monetization offerings such as DevPay offer developers the opportunity to make money from applications developed to use the services.

The verification will reference to the S3 and DevPay services for example purposes only as many options such as FTP, SimpleDB, solid state storage and others can be used to host the token hosting needed for the verification element of this invention. The token represents permission from the content provider to grant access rights to the excelsior enabler and thereafter the plurality of secondary enablers. To set up the verification the content provider can manually or automatically generate a single or a plurality of structured or random password in which will represent the token. By using public or private access of S3 as part of an apparatus, the content provider can create empty text files giving each the name of the passwords generated. Because S3 is associated with a highly available worldwide infrastructure, to check this password token can be done my simply constructing a HTTP request from the apparatus and triggering follow up actions based on either a 200 HTTP response, which means OK at which point the next action can happen, or a 400 HTTP response which means ERROR at which point the verification process is voided. An additional token can be used to provide a flag to the apparatus that the verification element has been fulfilled for an initial verification token. Creating an alternate version of the first token by appending a reference to the end, for example, does this: “M11DFJGH34KF_user@str3em.com_01_01_11”. In this example, it is defined that the eleven month authorized membership token was verified by a user@str3em.com on Jan. 1, 2011. By providing a second token, the first token becomes locked to ownership by the excelsior enabler preventing unauthorized users from reusing the first token without providing the authentication associated with the alternative referenced second token. In the interest of providers of the apparatus delivering this invention, this document will teach a method of a HTTP PUT calculation scheme for automatic royalty billing and administration for the token element used in the invention. Amazon’s DevPay allow developers to attach monetary charges to data services of S3 offered as an embedded component of the apparatus. By using the “PUT” requests parameter, tokens generated by the apparatus are monitored, calculated, and charged to clients of the apparatus provider. For example: the default charge measure for DevPay is \$0.05 for every 1000 PUT requests. By changing the amount to \$100 for every 1000 PUT requests, the apparatus provider is paid a \$0.10 royalty for each token created. Content providers using a connected apparatus like DevPay to deliver and manage digital media distribution do not need to have restrictions on the tokens created as with prior art DRM key providers as DevPay is charged on a pay-as-you-need model on a monthly basis. As a novelty to the apparatus provider, if a content provider fails to pay royalties due, the DevPay hosting will automatically deny token access to all

10

related media products in distribution and restore this verification element when royalties are paid in full.

The authentication element of this invention is at least handled first by the at least one excelsior enabler with a connection to a membership. In the present discussion, the connection is equal to the Internet and the membership is equal to a web service. Further, the web service must be available for two way data exchange to complete the authentication process of this invention. Data exchange with a web service is usually facilitated with a programmable communications console, at most times, will be an Applications Programmable Interface (API). An API is a set of routines, data structures, object classes, and/or protocols provided by libraries and/or operating system services in order to support the building of applications. An API may be language-dependent: that is, available only in a particular programming language, using the particular syntax and elements of the programming language to make the API convenient to use in this particular context. Alternatively an API may be language-independent: that is, written in a way that means it can be called from several programming languages (typically an assembly/C-level interface). This is a desired feature for a service-style API that is not bound to a particular process or system and is available as a remote procedure call. A more detailed description of API that can be used for an apparatus can be found in the book, “Professional Web APIs with PHP: eBay, Google, Paypal, Amazon, FedEx plus Web Feeds”, by Paul Reinheimer, Wrox publishers (2006). A program apparatus, scripts, often calls these APIs or sections of code residing on user computerized devices. For example, a web browser running on a user computer, cell phone, or other device can download a section of JavaScript or other code from a web server, and then use this code to in turn interact with the API of a remote Internet server system as desired. A Graphic User Interface (GUI) can be installed for human interaction or processes can be preprogrammed in a programmable script such as PHP, ASP.Net, Java, Ruby on Rails and others. The authentication element of the invention is usually embedded as a process of the apparatus but could be linked dynamically. In this document, the embedded version using a GUI will be used as reference. The web service equipped with the API is usually a well-known membership themed application in which the users must use an authentic identification. Some example includes Facebook in which as a rule, members are required to use their legal name identities. A reference number or name with the Facebook Platform API represents this information. Other verified web services in which real member names are required such as the LinkedIn API and the PayPal API and even others could be used, but for this discussion, Facebook will be used only as an example of how the authentication element of the invention is utilized. The Facebook API system, as well as others, operates based on an access authentication system called from a connected apparatus (which is usually an Internet powered desktop or browser based application) with an API Key, an Application Secret Key and could also include an Application ID. For example, the Facebook API Application Keys required to establish a data exchange session with the connected apparatus might look like:

```
API Key
37a925fc5ee9b4752af981b9a30e9a73gh
Application Secret
f2a2d92ef395cce88eb0261d4b4gsa782
Application ID
51920566446
```

The collective API keys are usually embedded in the source code of the apparatus, or stored on a remote Internet server, and could be included in the encrypted digital media metadata

and inserted on-the-fly into calls made to the API from the connected apparatus. This allows dynamic API connection of the apparatus using keys issued to individual content providers so in the event of a reprimand of a single the individual content provider by the API provider, the collective the individual content providers and the enablers of the connected apparatus are not affected.

Upon an access request of the digital media, the excelsior enabler interacts with the apparatus, usually software or web application, to enter membership credentials in a GUI front-end connected to the API. The membership credentials are usually comprised of a login element comprising a name, phrase, or e-mail address, and a secret password. The credentials can be generated by the enabler or automatically generated by the web service. Once the enabler authenticates their identity with the membership, the apparatus facilitating the data communication can request relevant information to fulfill the process chain of the invention. For example, Facebook API Platform defines members as ID numbers, so if a member's real name is John Doe, then Facebook API ID (also programmatically known as the FBID) would be 39485678. Once the enabler successfully sign in to the GUI element then the apparatus will query the API for at least one electronic identification reference, in this discussion is the FBID. The FBID is received to the permanent or temporary memory of the apparatus to sustain the branding and cross-referencing requirements of the invention. Additional information can be requested according to membership status or connected "friends" of the enabler. Additional information can be made required for successful authentication and includes: a minimum amount of total friends, a minimum amount of female friends, a minimum amount of male friends, a minimum amount of available pictures, a minimum age limit and other custom rules can be defined by the apparatus. An example of how this would work is a content provider can define a minimum of 32 Facebook friends are required to access an encrypted digital media asset offered for sale or promotion. This is achieved by the apparatus handling a access request in which the enabler has not yet acquired access rights by executing and parsing information returned by the Facebook "Friends.get" API command.

XML return example of the Facebook "Friends.get" API command where a plurality of FBID are returned to the apparatus for parsing additional information as may be required to satisfy successful authentication:

```
<?xml version="1.0" encoding="UTF-8"?>
<friends_get_response xmlns="http://api.facebook.com/1.0/"
xmlns:xsi="http://www.w3.org/2001/XMLSchema-instance"
xsi:schemaLocation="http://api.facebook.com/1.0/
http://api.facebook.com/1.0/facebook.xsd" list="true">
  <uid>222333</uid>
  <uid>1240079</uid>
</friends_get_response>
```

When authenticating a compatible device or machine which may not have access to a connection for the authentication element, a key file or part of the metadata thereof could be made on another connected compatible device or machine and allow the enabler to execute Friends.get API command to collect and store the complete list of a plurality of FBID to the key file or the metadata thereof. The compatible device or machine which may not have access to a connection for the authentication element with an embedded interaction console, usually a user GUI, can request and load the key file or part of the metadata thereof to save the complete list of a plurality of electronic identification references, in this discus-

sion is reference as the FBID, to storage or metadata as part of the compatible device or machine. This step ensures the cross-referencing element requirement of the invention can take place in the event the connection for the authentication element is not present in the compatible device or machine.

Another example is a content provider can allow shared access to friends of the excelsior enabler after a time period, like for example, 90 days. After the 90 day period, when media access is requested using the authentication element by a plurality of secondary enablers, which are usually friends and family of the excelsior enabler, the FBID of the excelsior enabler is cross-referenced with the FBID of the requesting secondary enabler by way of the apparatus ability to execute the Facebook "Friends.areFriends" API command.

XML return example of the Facebook "Friends.areFriends" API command where FBID 2223322 and 2222333 are friends and FBID 1240077 and 1240079 are not friends:

```
<?xml version="1.0" encoding="UTF-8"?>
<friends_areFriends_response
xmlns=http://api.facebook.com/1.0/
xmlns:xsi=http://www.w3.org/2001/XMLSchema-instance
xsi:schemaLocation="http://api.facebook.com/1.0/
http://api.facebook.com/1.0/facebook.xsd" list="true">
  <friend_info>
    <uid1>222332</uid1><uid2>222333</uid2>
    <are_friends>1</are_friends>
  </friend_info>
  <friend_info>
    <uid1>1240077</uid1><uid2>1240079</uid2>
    <are_friends>0</are_friends>
  </friend_info>
</friends_areFriends_response>
```

Such usability can be important to sustain "fair use" rights of consumers of the digital media to emulate usability found with physical media products such as CD and DVD that can be loaned to friends and family after an inception grace period.

Once the information of the verification and authentication elements is acquired, the apparatus handles the next process of writing the information to the digital media metadata and can include additional information gathered from components of The App. Components of The App can include MAC address from a networking card, CRC checksum of an embedded file or circuit, SOC identifier, embedded serial number, OS version, web browser version, and many other identifiable components as part of The App. For this discussion, the MAC address from a networking card as part of The App will be used as reference of a secondary electronic identification reference. In computer networking, a Media Access Control address (MAC address) is a unique identifier assigned to most network adapters or network interface cards (NICs) by the manufacturer for identification, and used in the Media Access Control protocol sub-layer. If assigned by the manufacturer, a MAC address usually encodes the manufacturer's registered identification number. It may also be known as an Ethernet Hardware Address (EHA), hardware address, adapter address, or physical address. The novelty of embedding the MAC address along with the FBID of the excelsior enabler is to provide a plurality of electronic identification references in which cross-referencing actions can allow more rapid access to be granted with less interaction from an enabler. For example, to retrieve the FBID from Facebook to cross-reference with the FBID stored in the digital media metadata requires the enabler to possibly physically need to enter their login and password credentials to the GUI connected to the apparatus. It may be possible that web browser

US 8,887,308 B2

13

cookies allow automatic Facebook login by storing an active session key, but the session key is not guaranteed to be active at the time of an access request. While the enabler may not have an issue executing another authentication command, several remote operations could exist to control authentication and access requests separately from each other. The apparatus can execute a programmable retrieval command, usually a GET command, to locate and retrieve the MAC address from an attached or connected networking card. After the FBID is acquired, the MAC address is also acquired to write the plurality of electronic identifications to the metadata of the at least one encrypted digital media asset by; obtaining the decryption key to decrypt the encrypted digital media asset which is usually stored encoded, no encoded, encrypted, or no encrypted as part of the apparatus or as part of a connected source, usually an Internet server with an encrypted HTTPS protocol. A plurality of MAC addresses can be stored along with the FBID of the excelsior enabler to manage access rights across a plurality of devices. To understand metadata and the uses, metadata is defined simply as to “describe other data”. It provides information about certain item’s content. For example, an image may include metadata that describes how large the picture is, the color depth, the image resolution, when the image was created, and other data. A text document’s metadata may contain information about how long the document is, who the author is, when the document was written, and a short summary of the document. Web pages often include metadata in the form of Meta tags. Description and keywords Meta tags are commonly used to describe the Web page’s content. Most search engines use this data when adding pages to their search index. In the invention, the FBID and MAC addresses are written to the digital media asset metadata to prepare for the instant or delayed cross-referencing element of the invention. The same process of writing the information to the digital media metadata is true with secondary enablers allowing the same benefits of cross-referencing.

Cross-referencing, the last element of the invention is used to verify access rights of an enabler of a pre or post personalized encrypted digital media asset. Once an enabler executes an action for access request, the apparatus will obtain the decryption key to first seek the MAC address record. If the MAC address is found, then a cross-reference process is executed by comparing the MAC address retrieved from the metadata of the digital media file with the MAC address retrieved from the networking card connected to the apparatus or The App. If the comparison action proves to be true, then access rights are granted to the enabler. If the comparison fails, then the apparatus can either ask the enabler to participate in communication with the authentication element of the invention, or could deny further interactivity with the enabler. In this discussion, the apparatus requires the enabler to participate in communication with the authentication element to provide credentials to establish a cross-reference comparison with the FBID retrieved from the metadata and the FBID retrieved from the Facebook API. If the comparison action proves to be true, then access rights is granted to the excelsior enabler and the current MAC address of the networking card as part of The App is appended to the metadata of the encrypted digital media asset and access rights is granted to the excelsior enabler. If the FBID cross-reference fails, then the apparatus can either ask the potential secondary enabler to participate in communication with the authentication element of the invention, or could deny further interactivity with the potential secondary enabler. In this discussion, the apparatus requires the potential secondary enabler to participate in communication with the authentication element to

14

provide credentials to establish a cross-reference comparison with the FBID retrieved from the metadata and the FBID retrieved from the Facebook “Friends.areFriends” API command to determine if the potential secondary enabler identity is true or false. The determination is in accordance to any possible access grace periods set by the content provider of the encrypted digital media asset. If the comparison action proves to be true, then access rights is granted to the secondary enabler and the current MAC address of the networking card as part of The App and the FBID retrieved are appended to the established metadata information of the encrypted digital media asset and access rights can be granted to a plurality of secondary enablers; unlimited interoperability between devices and “fair use” sharing partners for an infinite time frame while protecting commercial digital media from unlicensed distribution to sustain long-term return of investments is achieved.

While the present invention has been described in connection with preferred embodiments, it will be understood by those skilled in the art that variations and modifications of the preferred embodiments described above may be made without departing from the scope of the invention. Other embodiments will be apparent to those skilled in the art from a consideration of the specification or from a practice of the invention disclosed herein. It is intended that the specification and the described examples are considered exemplary only, with the true scope of the invention indicated by the following claims.

What is claimed is:

1. A process for transforming a user access request for cloud digital content into a computer readable authorization object, the process for transforming comprising:
 - a) receiving an access request for cloud digital content through an apparatus in process with at least one CPU, the access request being a write request to a data store, wherein the data store is at least one of:
 - a memory connected to the at least one CPU;
 - a storage connected to the at least one CPU; and
 - a database connected to the at least one CPU through the Internet; wherein
 the access request further comprises verification data provided by at least one user, wherein the verification data is recognized by the apparatus as a verification token; then
 - b) authenticating the verification token of (a) using a database recognized by the apparatus of (a) as a verification token database; then
 - c) establishing an API communication between the apparatus of (a) and a database apparatus, the database apparatus being a different database from the verification token database of (b) wherein the API is related to a verified web service, wherein the verified web service is a part of the database apparatus, wherein establishing the API communication requires a credential assigned to the apparatus of (a), wherein the apparatus assigned credential is recognized as a permission to conduct a data exchange session between the apparatus of (a) and the database apparatus to complete the verification process, wherein the data exchange session is also capable of an exchange of query data, wherein the query data comprises at least one verified web service account identifier; then
 - d) requesting the query data, from the apparatus of (a), from the API communication data exchange session of (c), wherein the query data request is a request for the at least one verified web service identifier;
- then

US 8,887,308 B2

15

e) receiving the query data requested in (d) from the API communication data exchange session of (c); and
f) creating a computer readable authorization object by writing into the data store of (a) at least one of:
the received verification data of (a); and
the received query data of (e); wherein
the created computer readable authorization object is recognized by the apparatus of (a) as user access rights associated to the cloud digital content, wherein the computer readable authorization object is processed by the apparatus of (a) using a cross-referencing action during subsequent user access requests to determine one or more of a user access permission for the cloud digital content.

* * * * *

15

16