

1 Brent H. Blakely (SBN 157292)
2 bblakely@blakelylawgroup.com
3 Cindy Chan (SBN 247495)
4 cchan@blakelylawgroup.com
5 **BLAKELY LAW GROUP**
6 915 North Citrus Avenue
7 Los Angeles, California 90038
8 Telephone: (323) 464-7400
9 Facsimile: (323) 464-7410

10 *Attorneys for Plaintiff*
11 *Deckers Outdoor Corporation*

FILED
12 AUG 28 PM 1:19
CLERK U.S. DISTRICT COURT
CENTRAL DIST. OF CALIF.
LOS ANGELES

12 UNITED STATES DISTRICT COURT
13 CENTRAL DISTRICT OF CALIFORNIA

14 **CV12-07382** ODW(SH)x
15 CASE NO. CV

16 DECKERS OUTDOOR CORPORATION,
17 a Delaware Corporation,

18 Plaintiff,

19 v.

20 SHOESCANDAL.COM, LLC, a Nevada
21 Limited Liability Company; and DOES 1-
22 10, inclusive,

23 Defendants.

24 **COMPLAINT FOR DAMAGES:**

- 25 1. **PATENT INFRINGEMENT;**
- 26 2. **COMMON LAW UNFAIR
27 COMPETITION**

28 **JURY TRIAL DEMANDED**

1 Plaintiff **Deckers Outdoor Corporation** for its claims against Defendant
2 **ShoeScandal.com, LLC** respectfully alleges as follows:

3 **JURISDICTION AND VENUE**

4 1. Plaintiff files this action against Defendant for patent infringement arising
5 under the patent laws of the United States. This Court has subject matter jurisdiction
6 over the claims alleged in this action pursuant to 28 U.S.C. §§ 1331, 1338.

7 2. This Court has personal jurisdiction over Defendant because Defendant
8 does business within this judicial district.

9 3. This action arises out of wrongful acts by Defendant within this judicial
10 district and Plaintiff is located and has been injured in this judicial district by

1 Defendant's alleged wrongful acts. Venue is proper in this district pursuant to 28
2 U.S.C. § 1391 because the claims asserted arise in this district.

3 **THE PARTIES**

4 4. Plaintiff Deckers Outdoor Corporation ("Deckers") is a corporation
5 organized and existing under the laws of the state of Delaware with an office and
6 principal place of business in Goleta, California. Deckers designs and markets
7 footwear identified by its famous UGG® trademark and other famous trademarks.

8 5. Upon information and belief, Defendant ShoeScandal.com, LLC is a
9 limited liability company duly organized and existing under the laws of the state of
10 Nevada with an office and principal place of business at 555 West 59th Street, Suite 10-
11 H, New York, New York 10019.

12 6. Plaintiff is unaware of the names and true capacities of Defendants,
13 whether individual, corporate and/or partnership entities, named herein as DOES 1
14 through 10, inclusive, and therefore sues them by their fictitious names. Plaintiff will
15 seek leave to amend this complaint when their true names and capacities are
16 ascertained. Plaintiff is informed and believes and based thereon alleges that said
17 Defendant and DOES 1 through 10, inclusive, are in some manner responsible for the
18 wrongs alleged herein, and that at all times referenced each was the agent and servant
19 of the other Defendant and was acting within the course and scope of said agency and
20 employment.

21 7. Plaintiff is informed and believes, and based thereon alleges, that at all
22 relevant times herein, Defendant and DOES 1 through 10, inclusive, knew or
23 reasonably should have known of the acts and behavior alleged herein and the damages
24 caused thereby, and by their inaction ratified and encouraged such acts and behavior.
25 Plaintiff further alleges that Defendant and DOES 1 through 10, inclusive, have a non-
26 delegable duty to prevent or not further such acts and the behavior described herein,
27 which duty Defendant and DOES 1 though 10, inclusive, failed and/or refused to
28 perform.

1
2
3
4
5
6
7
8
9
10
11
12
13
14
15
16
17
18
19
20
21
22
23
24
25
26
27
28

ALLEGATIONS COMMON TO ALL CAUSES OF ACTION

A. Deckers' UGG® Brand

8. Deckers has become well known throughout the United States and elsewhere as a source of high quality footwear products identified at least by its UGG® brand of premium footwear.

9. Deckers' UGG® products are distributed and sold to consumers through retailers throughout the United States at point of sale and on the Internet, including through its website www.uggaustralia.com.

10. Deckers has spent substantial time, effort, and money in designing, developing, advertising, promoting, and marketing its famous UGG® Australia line of footwear. Deckers' efforts have been successful and Deckers has sold a substantial amount of UGG® Australia footwear.

11. Many of Deckers' UGG® footwear designs are protected by design patents issued by the United States Patent and Trademark Office. Design Patents for UGG® footwear include, but are not limited to, U.S. Patent Nos. D599,999 (registered on September 15, 1999), and D616,189 (registered on May 25, 2010) (hereinafter, collectively, "UGG Designs"). Attached hereto and incorporated herein as Exhibit 1 are true and correct copies of the registered design patents for the UGG Designs.

12. Deckers is the lawful assignee of all right, title, and interest in and to the UGG Designs.

B. Defendant's Infringement of the UGG Designs

13. Upon information and belief, Plaintiff hereon avers that Defendant ShoeScandal.com, LLC advertises, offers for sale, and sells shoes through its online store – www.shoescandal.com.

14. Customers nationwide, including those within this judicial district, can purchase Defendant's shoes via its website - www.shoescandal.com.

1 15. Defendant has offered and is currently advertising, offering for sale, and
2 selling footwear with designs nearly identical to that of the UGG Designs (“Infringing
3 Products”) on www.shoescandal.com. See below image comparison.

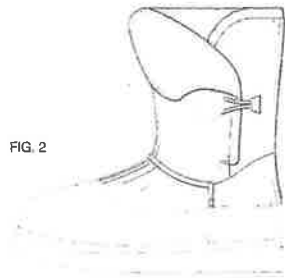

8
9 **Ugg Design Patent No. D599,999**



Defendant’s Infringing Product

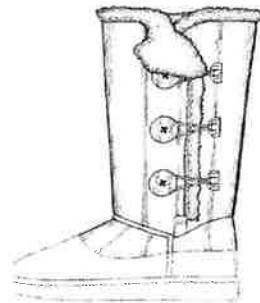

15 **Ugg Design Patent No. D616,189**



Defendant’s Infringing Product

16 16. Deckers has not granted a license or any other form of permission to
17 Defendant with respect to the UGG Designs.

18 **FIRST CLAIM FOR RELIEF**

19 **(Patent Infringement – 35 U.S.C. § 271)**

20 17. Plaintiff incorporates herein by reference the averments of the preceding
21 paragraphs as though fully set forth herein.

22 18. Plaintiff Deckers Outdoor Corporation is the owner by assignment of all
23 right, title and interest in and to the design patents for the UGG Designs.

24 19. Defendant has knowingly and intentionally manufactured, caused to be
25 produced, distributed, advertised, marketed, offered for sale, and/or sold footwear that
26 is nearly identical to the UGG Designs in direct violation of 35 U.S.C. § 271.

27 20. Defendant’s use of the UGG Designs is without Plaintiff’s permission or
28 authority and is in total disregard of Plaintiff’s right to control its intellectual property.

1 21. As a direct and proximate result of Defendant's infringing conduct,
2 Plaintiff has been injured and will continue to suffer injury to its business and
3 reputation unless Defendant is restrained by this Court from infringing Plaintiff's
4 design patents.

5 22. Defendant's acts have damaged and will continue to damage Plaintiff, and
6 Plaintiff has no adequate remedy at law.

7 23. On information and belief, Defendant's acts herein complained of
8 constitute willful acts and intentional infringement of the UGG Designs.

9 24. In light of the foregoing, Plaintiff is entitled to injunctive relief
10 prohibiting Defendant from using the UGG Designs and to recover from Defendant all
11 damages, including attorneys' fees, that Plaintiff has sustained and will sustain as a
12 result of such infringing acts, and all gains, profits and advantages obtained by
13 Defendant as a result thereof, in an amount to be determined, which amount can be
14 trebled under 35 U.S.C. § 284.

15 **SECOND CLAIM FOR RELIEF**

16 **Unfair Competition Under California Common Law**

17 25. Plaintiff incorporates herein by reference the averments of the preceding
18 paragraphs as though fully set forth herein.

19 26. Defendant's infringement of Plaintiff's UGG Designs constitutes unfair
20 competition in violation of the common law of the State of California.

21 27. Plaintiff has no adequate remedy at law to compensate it fully for the
22 damages that have been caused and which will continue to be caused by Defendant's
23 infringing conduct, unless it is enjoined by this Court.

24 28. In light of the foregoing, Plaintiff is entitled to injunctive relief
25 prohibiting Defendant from using the UGG Designs, and to recover all damages,
26 including attorneys' fees, that Plaintiff has sustained and will sustain, and all gains,
27 profits and advantages obtained by Defendant as a result of its infringing acts alleged
28 above in an amount not yet known, and the costs of this action.

1 29. The conduct herein complained of was extreme, outrageous, fraudulent,
2 and was inflicted on Plaintiff in reckless disregard of Plaintiff's rights. Said conduct
3 was despicable and harmful to Plaintiff and as such supports an award of exemplary
4 and punitive damages in an amount sufficient to punish and make an example of
5 Defendant, and to deter it from similar such conduct in the future.

6 **PRAYER FOR RELIEF**

7 WHEREFORE, Plaintiff respectfully prays for judgment against Defendant, as
8 follows:

- 9 1. A Judgment that Defendant has infringed the UGG Designs
10 in violation of 35 U.S.C. § 271 and that Defendant's infringement was willful;
- 11 2. An order granting temporary, preliminary and permanent injunctive relief
12 restraining and enjoining Defendant, its officers, agents, employees, and attorneys, and
13 all those persons or entities in active concert or participation with them from:
- 14 (a) manufacturing, importing, advertising, marketing, promoting,
15 supplying, distributing, offering for sale, or selling any products that infringe upon the
16 UGG Designs, including the Infringing Products;
- 17 (b) engaging in any other activity constituting unfair competition with
18 Plaintiff, or acts and practices that deceive consumers, the public, and/or trade,
19 including without limitation, the use of designations and design elements used or
20 owned by or associated with Plaintiff; and
- 21 (c) committing any other act which falsely represents or which has the
22 effect of falsely representing that the goods and services of Defendant are licensed by,
23 authorized by, offered by, produced by, sponsored by, or in any other way associated
24 with Plaintiff;
- 25 3. Ordering Defendant to recall from any distributors and retailers and to
26 deliver to Plaintiff for destruction or other disposition all remaining inventory of all
27 Infringing Products and related items, including all advertisements, promotional and
28 marketing materials therefore, as well as means of making same;

- 1 4. Ordering Defendant to file with this Court and serve on Plaintiff within
2 thirty (30) days after entry of the injunction a report in writing, under oath setting forth
3 in detail the manner and form in which Defendant has complied with the injunction;
- 4 5. Ordering an accounting by Defendant of all gains, profits and advantages
5 derived from their wrongful acts;
- 6 6. Awarding Plaintiff all of Defendant's profits and all damages sustained by
7 Plaintiff as a result of Defendant's wrongful acts, and such other compensatory
8 damages as the Court determines to be fair and appropriate;
- 9 7. Increasing the damages up to three times the amount found or assessed
10 under 35 U.S.C. § 284;
- 11 8. Awarding applicable interest, costs, disbursements and attorneys' fees;
- 12 9. Finding that this is an exceptional case under 35 U.S.C. § 285 and
13 awarding attorneys' fees thereunder;
- 14 10. Awarding Plaintiff's punitive damages in connection with its claims under
15 California law; and
- 16 11. Such other relief as may be just and proper.

17 Dated: August 27, 2012

BLAKELY LAW GROUP

18
19 By:



Brent H. Blakely
Cindy Chan

Attorneys for Plaintiff
Deckers Outdoor Corporation

1
2
3
4
5
6
7
8
9
10
11
12
13
14
15
16
17
18
19
20
21
22
23
24
25
26
27
28

DEMAND FOR JURY TRIAL

Pursuant to Rule 38(b) of the Federal Rules of Civil Procedure, Plaintiff hereby demands a trial by jury as to all claims in this litigation.

Dated: August 27, 2012

BLAKELY LAW GROUP

By: 
Brent H. Blakely
Cindy Chan
Attorneys for Plaintiff
Deckers Outdoor Corporation



US00D599999S

(12) **United States Design Patent** (10) **Patent No.:** **US D599,999 S**
MacIntyre (45) **Date of Patent:** **** Sep. 15, 2009**

(54) **PORTION OF A FOOTWEAR UPPER**
(75) **Inventor:** **Jennifer MacIntyre**, Santa Barbara, CA (US)
(73) **Assignee:** **Deckers Outdoor Corporation**, Goleta, CA (US)
(**) **Term:** **14 Years**
(21) **Appl. No.:** **29/326,868**

EP 00718002-0006 4/2007

OTHER PUBLICATIONS

UGG Australia, Bipster model, p. 1, Oct. 3, 2008.
UGG Australia, Henry model, p. 1, Oct. 3, 2008.
UGG Australia, Erin model, p. 1, Oct. 3, 2008.
UGG Australia, Cove model, p. 1, Oct. 27, 2008.
UGG Australia, Kona model, p. 1, Oct. 27, 2008.
Catalogue Moscow Shoes, summer 2006, p. 2 top center.
Steve Madden MISSYY Brown Suede boot, www.jildorshoes.com, Dec. 9, 2008.

* cited by examiner

Primary Examiner—Stella M Reid
Assistant Examiner—Rashida C McCoy
(74) *Attorney, Agent, or Firm*—Greer, Burns & Crain, Ltd.

(22) **Filed:** **Oct. 27, 2008**
(51) **LOC (9) Cl.** **02-99**
(52) **U.S. Cl.** **D2/970; D2/911; D2/946**
(58) **Field of Classification Search** **D2/896,**
D2/909-915, 946, 970, 973, 974; 36/45,
36/50.1, 83, 3 A, 7.1 R, 113
See application file for complete search history.

(57) **CLAIM**

The ornamental design for a portion of a footwear upper, as shown and described.

(56) **References Cited**

U.S. PATENT DOCUMENTS

D125,568 S *	3/1941	Hard	D2/911
D155,573 S *	10/1949	Bingham	D2/910
D159,577 S *	8/1950	Stromberg	D2/900
D159,761 S *	8/1950	Barron	D2/910
D227,197 S *	6/1973	Fukuoka	D2/910
D319,332 S *	8/1991	Itzkowitz	D2/910
D481,863 S *	11/2003	Belley et al.	D2/970
D529,269 S *	10/2006	Belley et al.	D2/970
D539,024 S	3/2007	Belley et al.		
D581,140 S	11/2008	Earle		

FOREIGN PATENT DOCUMENTS

DE 40702148 8/2007

DESCRIPTION

FIG. 1 is a perspective view of a portion of a footwear upper showing my new design;

FIG. 2 is a side elevational view thereof;

FIG. 3 is an opposite side elevational view thereof;

FIG. 4 is a front elevational view thereof;

FIG. 5 is a rear elevational view thereof;

FIG. 6 is a top plan view thereof; and,

FIG. 7 is a bottom plan view thereof.

The broken lines in FIGS. 1-7 represent portions of the footwear that form no part of the claimed design. The broken line which defines the bounds of the claimed design forms no part thereof.

1 Claim, 6 Drawing Sheets



EXHIBIT 1

U.S. Patent

Sep. 15, 2009

Sheet 1 of 6

US D599,999 S

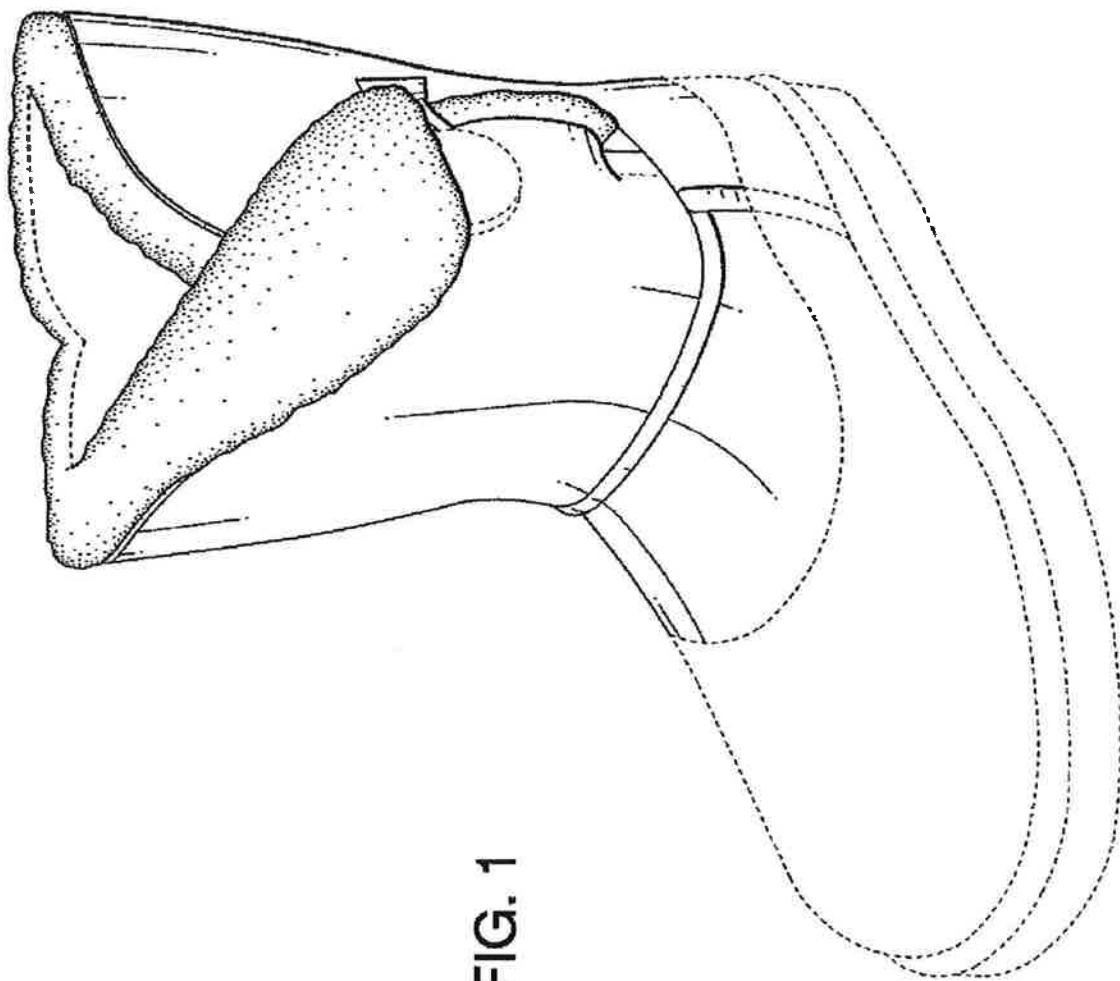

FIG. 1

U.S. Patent

Sep. 15, 2009

Sheet 2 of 6

US D599,999 S

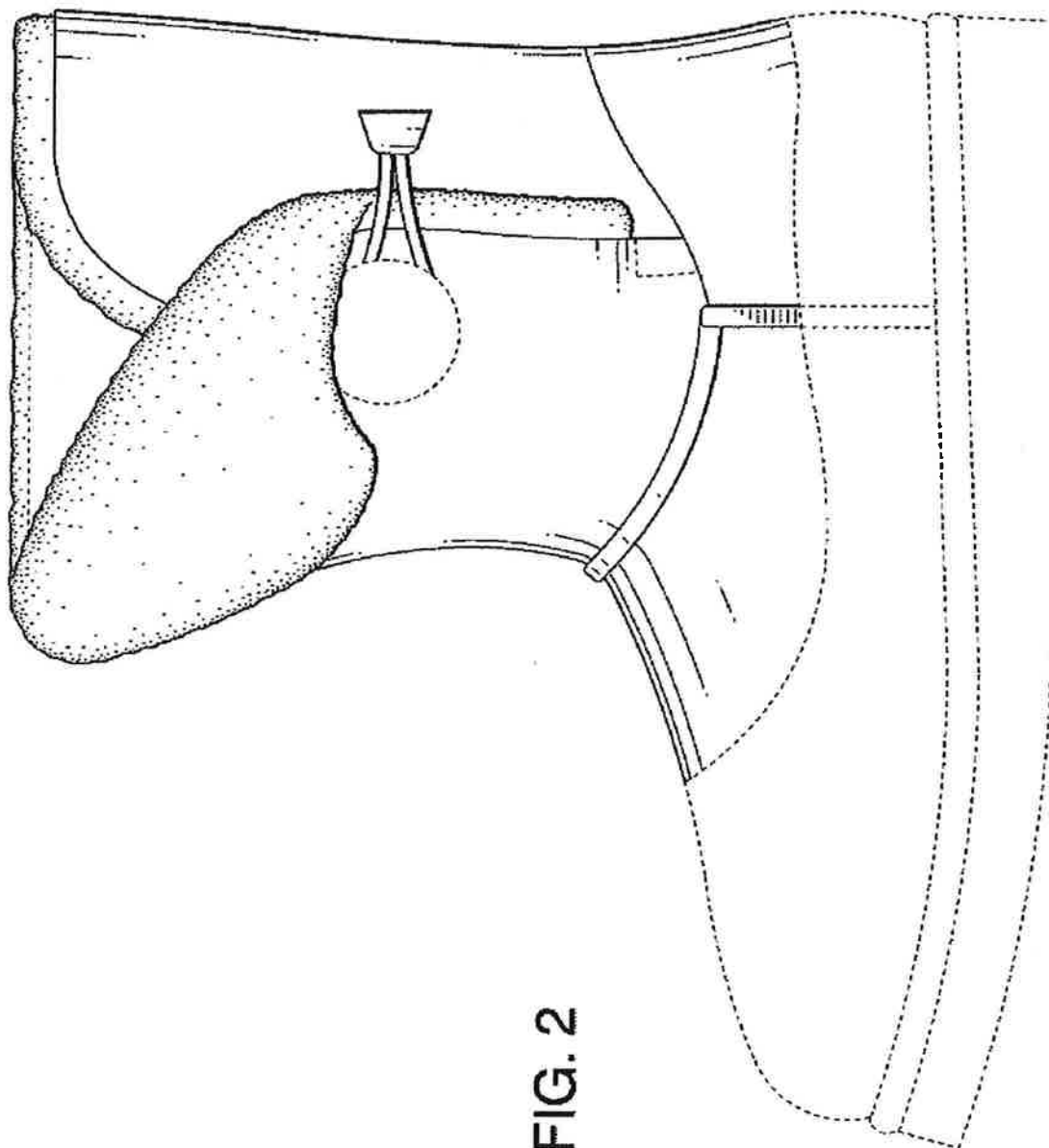

FIG. 2

U.S. Patent

Sep. 15, 2009

Sheet 3 of 6

US D599,999 S

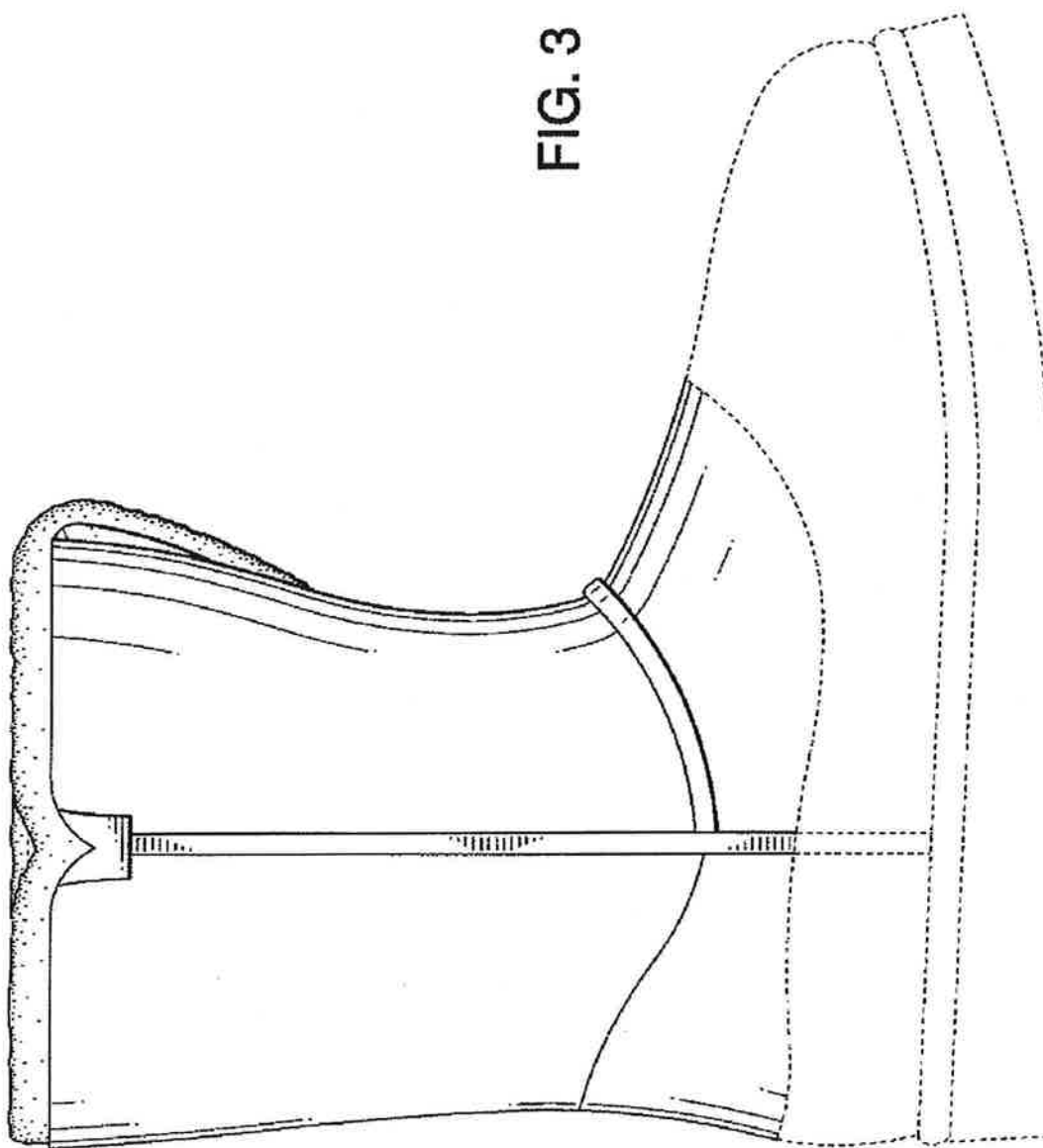

U.S. Patent

Sep. 15, 2009

Sheet 4 of 6

US D599,999 S

FIG. 5

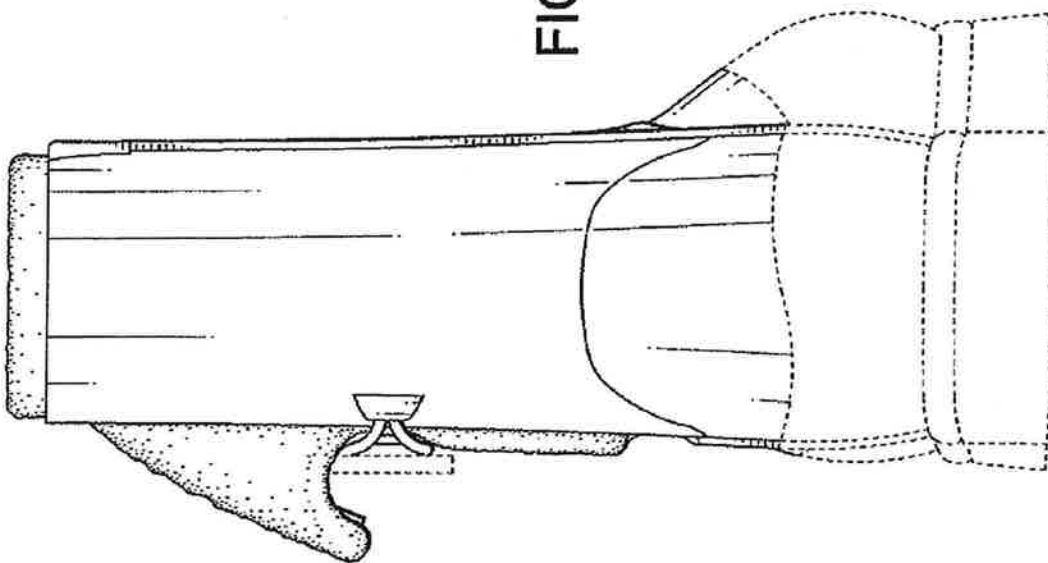
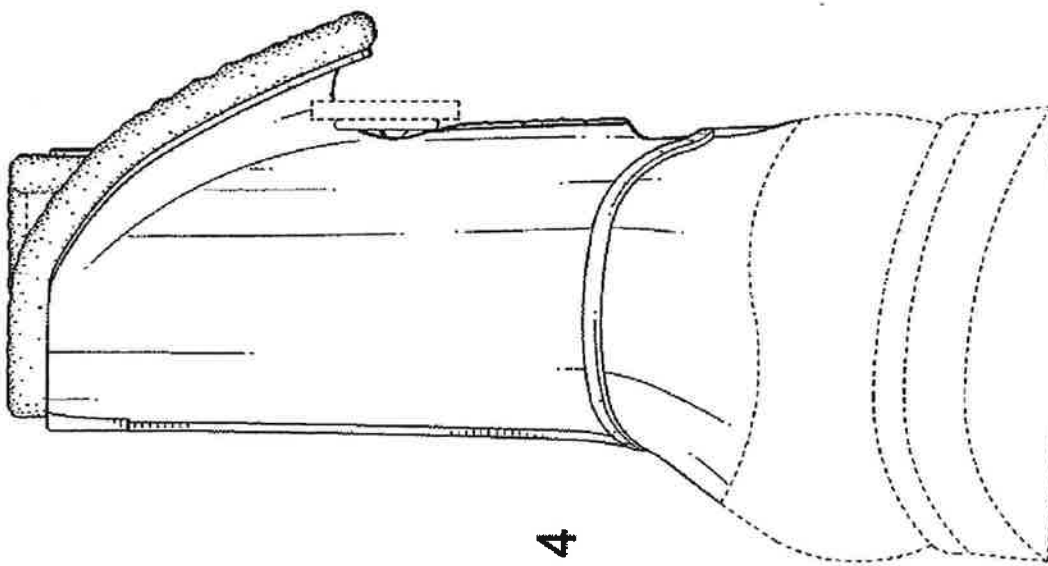

FIG. 4



U.S. Patent

Sep. 15, 2009

Sheet 5 of 6

US D599,999 S

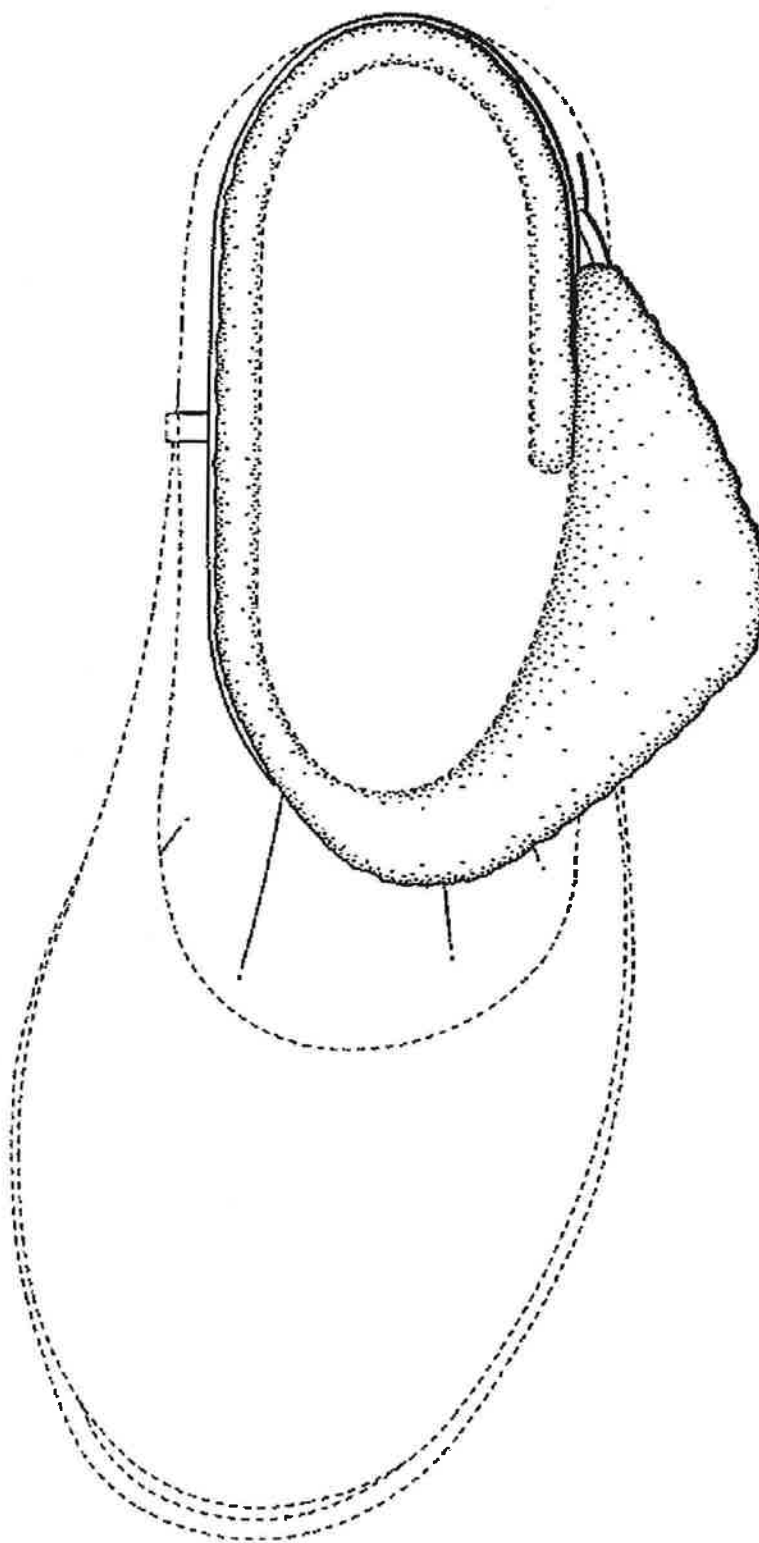

FIG. 6

U.S. Patent

Sep. 15, 2009

Sheet 6 of 6

US D599,999 S

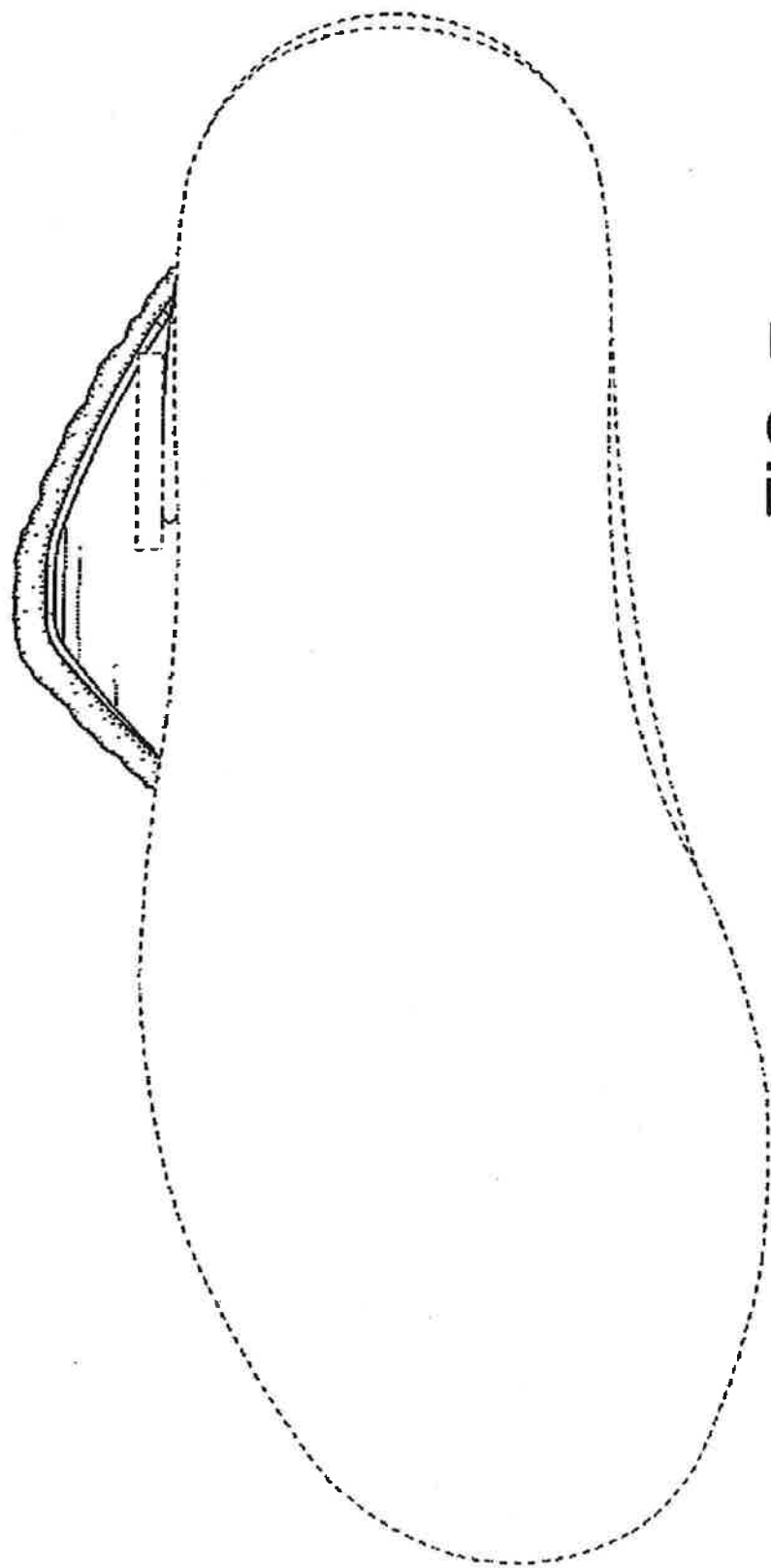

FIG. 7



US00D616189S

(12) **United States Design Patent**
MacIntyre

(10) **Patent No.:** US D616,189 S
(45) **Date of Patent:** ** *May 25, 2010

(54) **PORTION OF A FOOTWEAR UPPER**

D554,341 S * 11/2007 Belley et al. D2/970
D575,495 S 8/2008 Le
D580,158 S 11/2008 Belley et al.

(75) **Inventor:** Jennifer MacIntyre, Santa Barbara, CA (US)

(73) **Assignee:** Deckers Outdoor Corporation, Goleta, CA (US)

(Continued)

FOREIGN PATENT DOCUMENTS

(**) **Term:** 14 Years

DE 40702148 8/2007

(21) **Appl. No.:** 29/343,479

(Continued)

(22) **Filed:** Sep. 14, 2009

OTHER PUBLICATIONS

Related U.S. Application Data

UGG Australia, Bipster model, p. 1, Oct. 3, 2008.

(63) **Continuation-in-part of application No. 29/326,868, filed on Oct. 27, 2008, now Pat. No. Des. 599,999.**

(Continued)

(51) **LOC (9) CL.** 02-99
(52) **U.S. CL.** D2/970
(58) **Field of Classification Search** D2/896,
D2/902, 903, 905-915, 946, 970, 972, 974,
D2/976; 36/45, 50.1, 83, 3 A, 7.1 R, 113,
36/101, 112, 114, 116, 126-130, 48
See application file for complete search history.

Primary Examiner—Robert M Spear
Assistant Examiner—Rashida C McCoy
(74) *Attorney, Agent, or Firm*—Greer, Burns & Crain, Ltd.

(57) **CLAIM**

The ornamental design for a portion of a footwear upper, as shown and described.

(56) **References Cited**

U.S. PATENT DOCUMENTS

D21,954 S * 11/1892 Richardson D2/910
D125,568 S 3/1941 Hard
D155,573 S 10/1949 Bingham, Jr.
D159,577 S * 8/1950 Stromberg D2/900
D159,761 S * 8/1950 Barron D2/910
D227,197 S 6/1973 Fukuoka
D284,805 S * 7/1986 Smith D2/900
D319,332 S 8/1991 Itzkowitz
D357,572 S * 4/1995 Seiler et al. D2/910
D386,292 S * 11/1997 Brooks et al. D2/970
D386,294 S * 11/1997 Brooks et al. D2/970
D400,342 S * 11/1998 Davidowitz et al. D2/909
D481,863 S 11/2003 Belley et al.
D497,476 S * 10/2004 Huard et al. D2/970
D521,228 S * 5/2006 Kelsey D2/976
D529,269 S 10/2006 Belley et al.
D539,024 S * 3/2007 Belley et al. D2/970

DESCRIPTION

FIG. 1 is a perspective view of a portion of a footwear upper showing my new design;
FIG. 2 is a side elevational view thereof;
FIG. 3 is an opposite side elevational view thereof;
FIG. 4 is a front elevational view thereof;
FIG. 5 is a rear elevational view thereof; and,
FIG. 6 is a top plan view thereof.
The broken lines in FIGS. 1-6 represent portions of the footwear that form no part of the claimed design. The broken line which defines the bounds of the claimed design forms no part thereof.

1 Claim, 6 Drawing Sheets

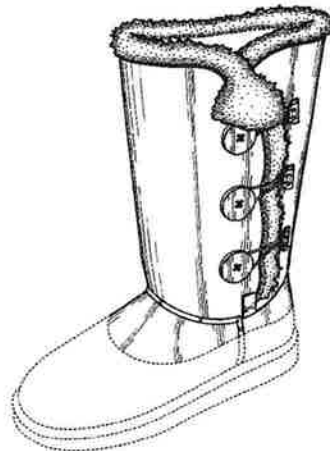

US D616,189 S

Page 2

U.S. PATENT DOCUMENTS

D581,140 S 11/2008 Earle
D585,636 S 2/2009 Earle
D591,496 S 5/2009 Earle

FOREIGN PATENT DOCUMENTS

EP 00718002-0006 4/2007
EP 001159008-0005 8/2009

OTHER PUBLICATIONS

UGG Australia, Henry model, p. 1, Oct. 3, 2008.
UGG Australia, Erin model, p. 1, Oct. 3, 2008.

UGG Australia, Cove model, p. 1, Oct. 27, 2008.

UGG Australia, Kona model, p. 1, Oct. 27, 2008.

Steve Madden MISSYY Brown Suede boot, www.jildorshoes.com, Dec. 9, 2008.

Catalogue Moscow Shoes, summer 2006, p. 2 top center.

UGG Australia 1990 Catalog, Classic Tall model, 1990.

UGG Australia Fall/Winter 2004 Catalog, Larkspur model, 2004.

Sportsmaster, Russian Federation, Autumn/Winter 2008-2009.

* cited by examiner

U.S. Patent

May 25, 2010

Sheet 1 of 6

US D616,189 S

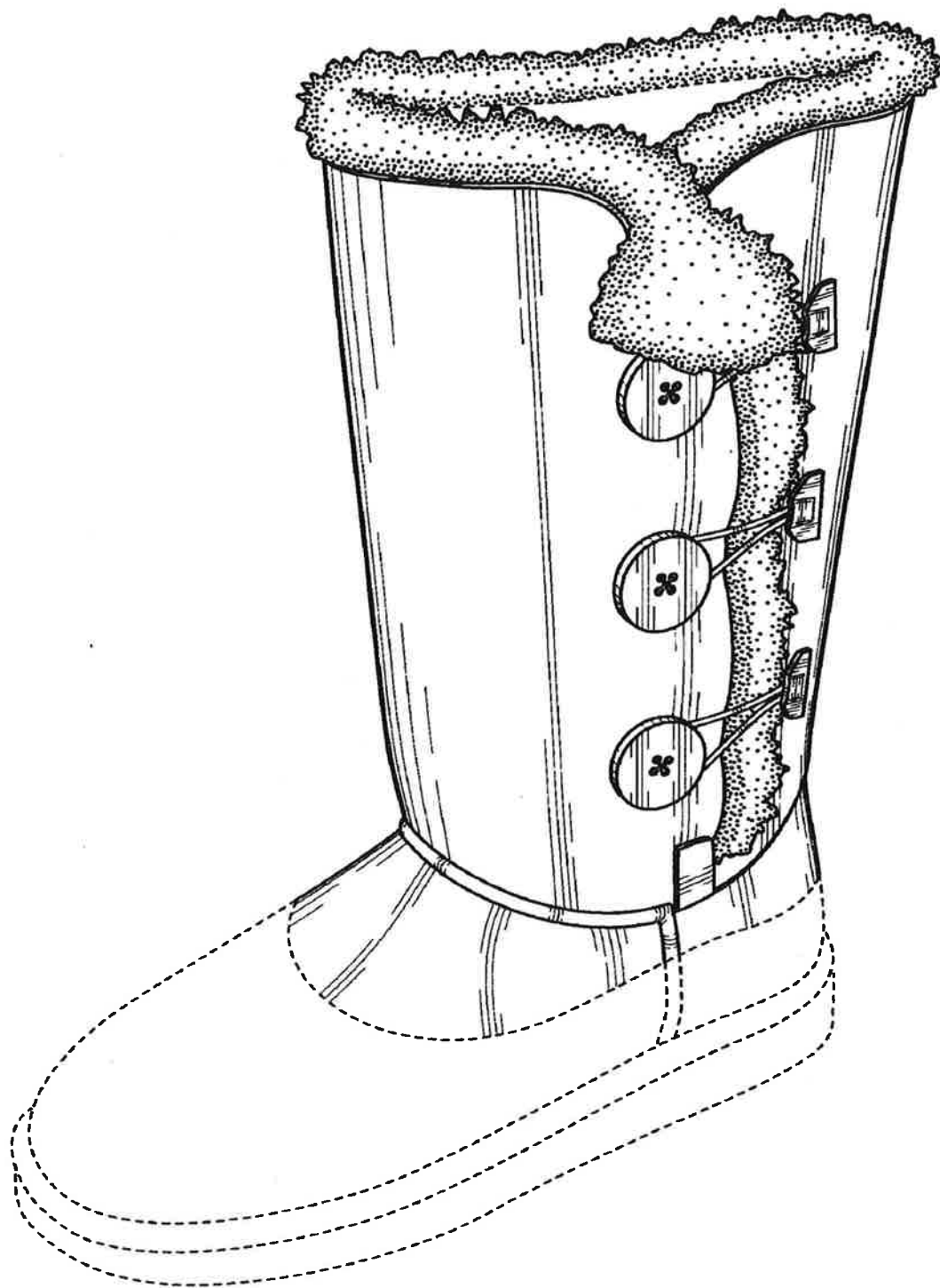

FIG. 1

U.S. Patent

May 25, 2010

Sheet 2 of 6

US D616,189 S

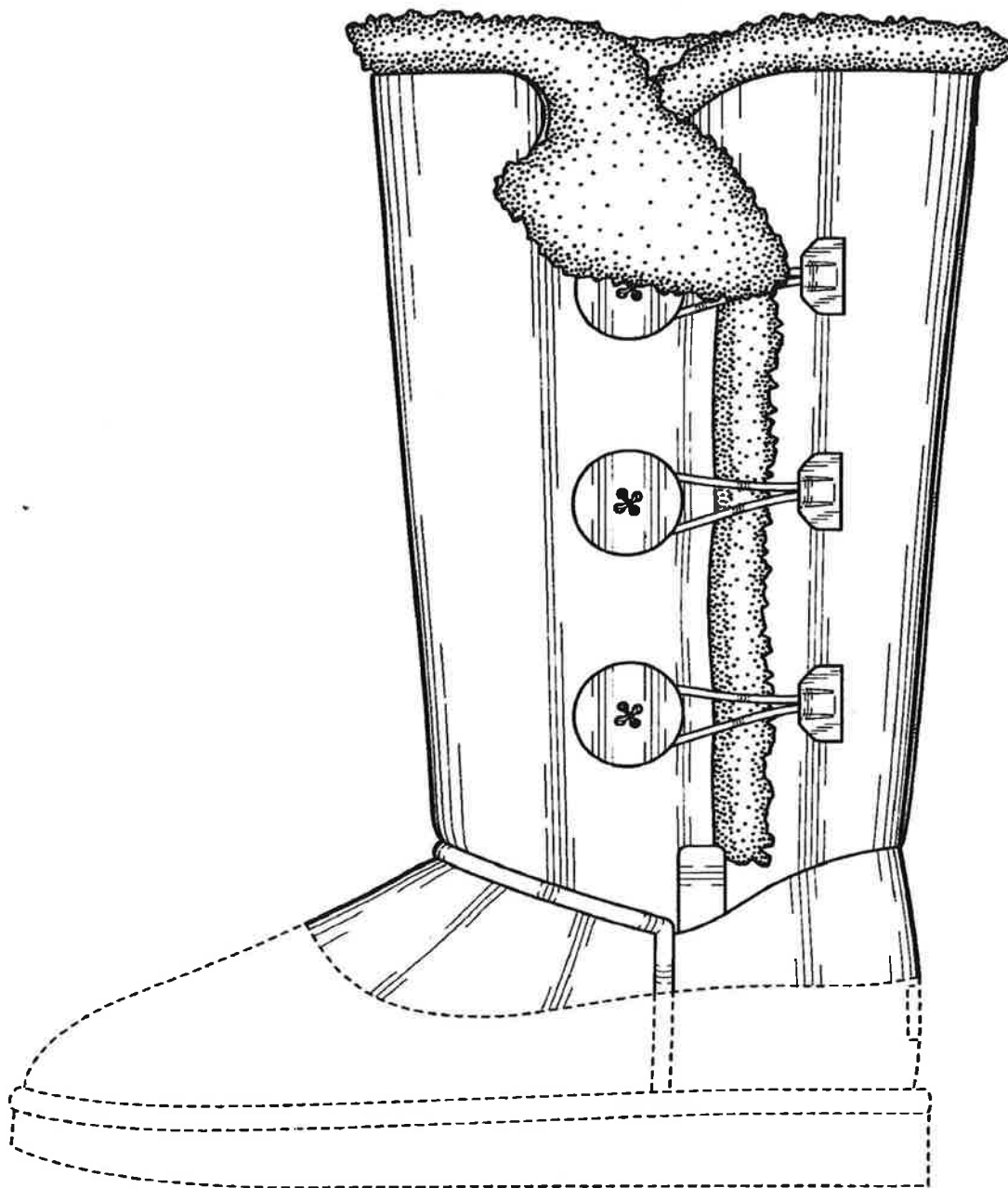

FIG. 2

U.S. Patent

May 25, 2010

Sheet 3 of 6

US D616,189 S

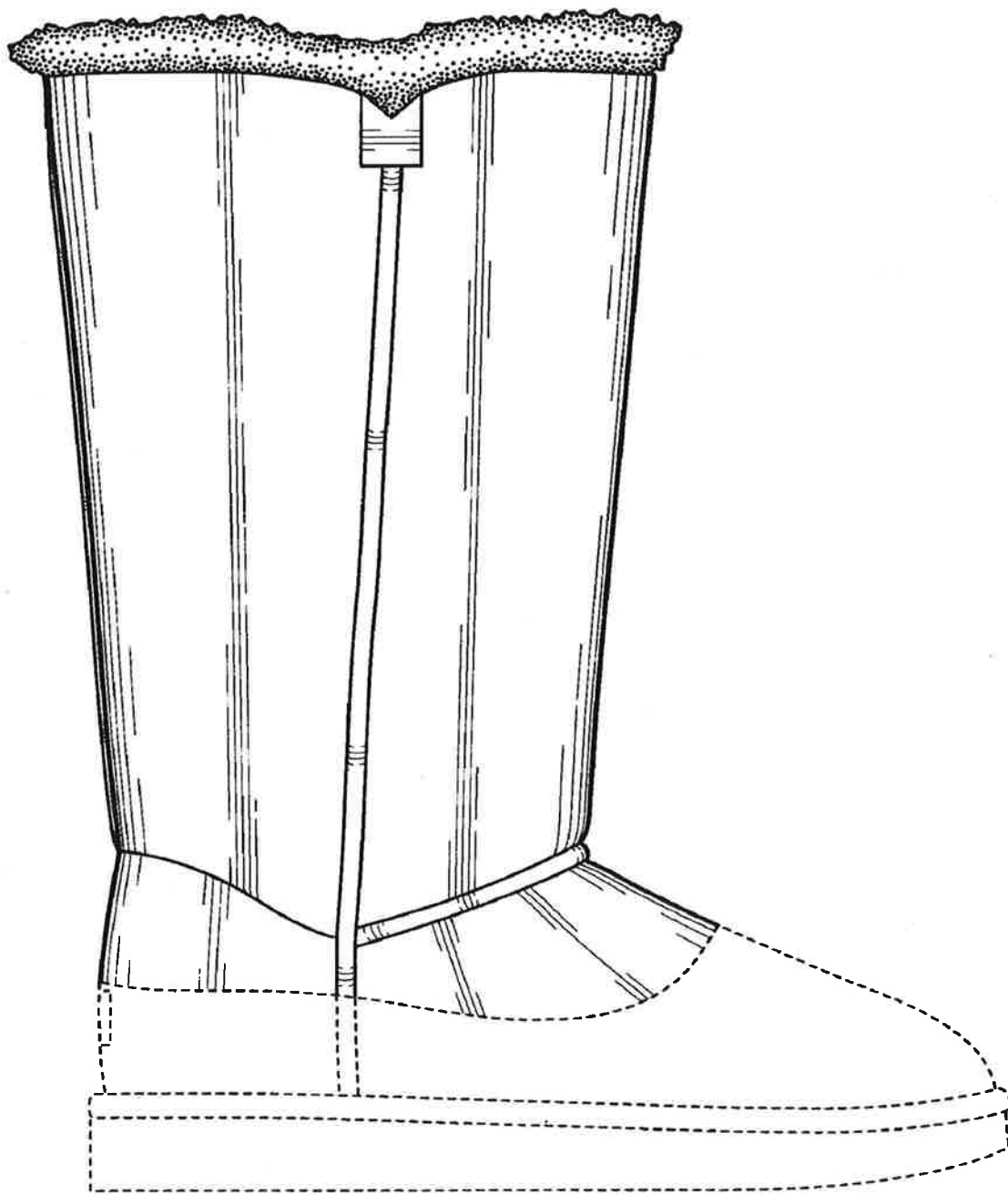

FIG. 3

U.S. Patent

May 25, 2010

Sheet 4 of 6

US D616,189 S

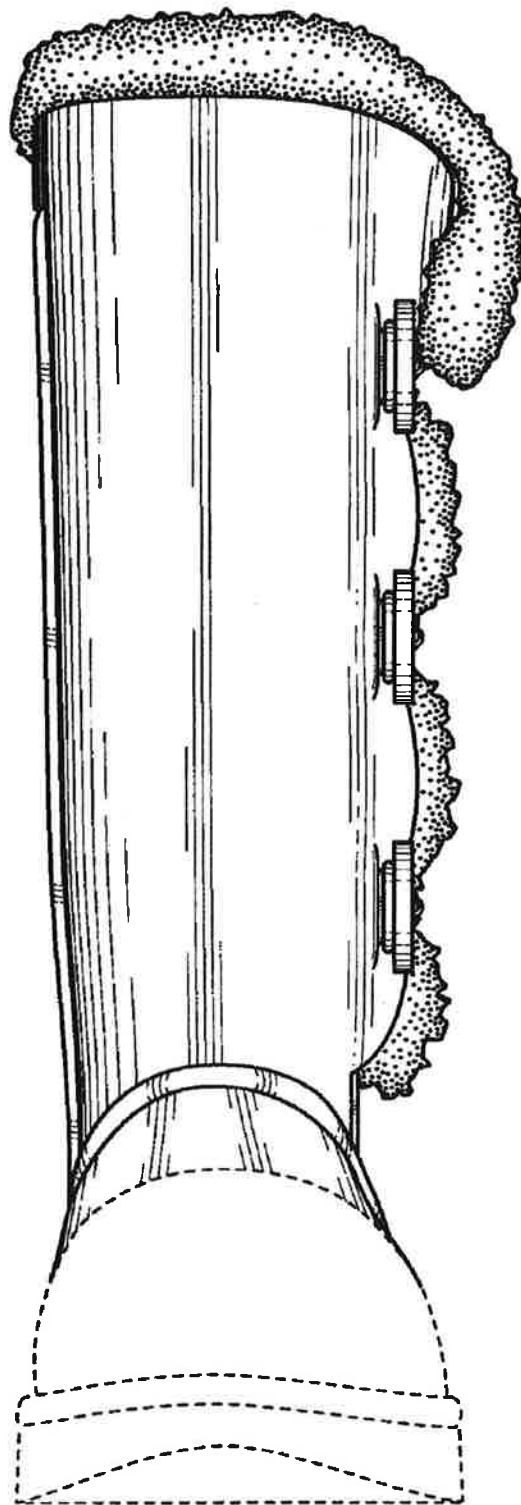

FIG. 4

U.S. Patent

May 25, 2010

Sheet 5 of 6

US D616,189 S

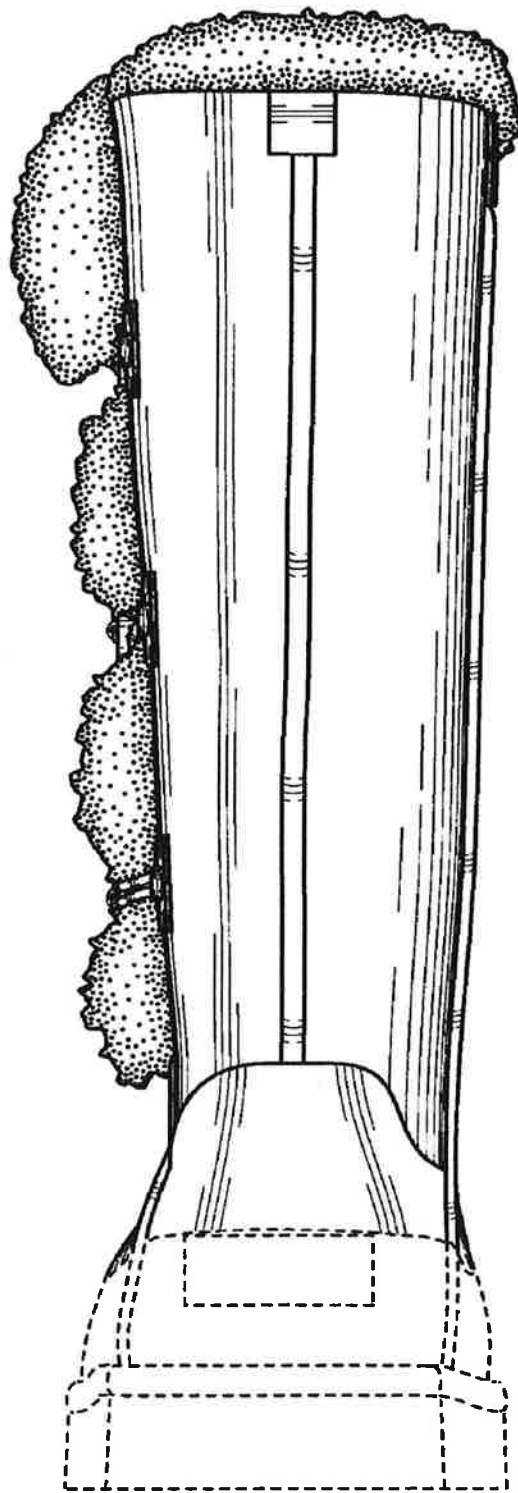

FIG. 5

U.S. Patent

May 25, 2010

Sheet 6 of 6

US D616,189 S

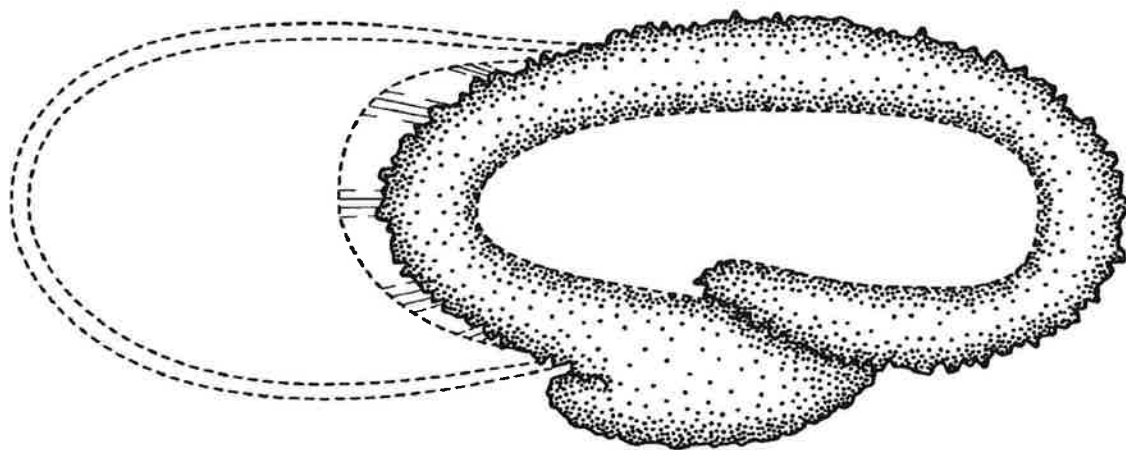

FIG. 6

UNITED STATES DISTRICT COURT, CENTRAL DISTRICT OF CALIFORNIA
CIVIL COVER SHEET

I (a) PLAINTIFFS (Check box if you are representing yourself <input type="checkbox"/>) Deckers Outdoor Corporation	DEFENDANTS Shoescandal.com, LLC
(b) Attorneys (Firm Name, Address and Telephone Number. If you are representing yourself, provide same.) BLAKELY LAW GROUP 915 North Citrus Avenue, Hollywood, California 90038 Telephone: (323) 464-7400	Attorneys (If Known)

II. BASIS OF JURISDICTION (Place an X in one box only.) <input type="checkbox"/> 1 U.S. Government Plaintiff <input checked="" type="checkbox"/> 3 Federal Question (U.S. Government Not a Party) <input type="checkbox"/> 2 U.S. Government Defendant <input type="checkbox"/> 4 Diversity (Indicate Citizenship of Parties in Item III)	III. CITIZENSHIP OF PRINCIPAL PARTIES - For Diversity Cases Only (Place an X in one box for plaintiff and one for defendant.) <table style="width:100%; border-collapse: collapse;"> <tr> <td style="width:30%;"></td> <td style="width:10%; text-align: center;">PTF</td> <td style="width:10%; text-align: center;">DEF</td> <td style="width:40%;"></td> <td style="width:10%; text-align: center;">PTF</td> <td style="width:10%; text-align: center;">DEF</td> </tr> <tr> <td>Citizen of This State</td> <td style="text-align: center;"><input type="checkbox"/> 1</td> <td style="text-align: center;"><input type="checkbox"/> 1</td> <td>Incorporated or Principal Place of Business in this State</td> <td style="text-align: center;"><input type="checkbox"/> 4</td> <td style="text-align: center;"><input type="checkbox"/> 4</td> </tr> <tr> <td>Citizen of Another State</td> <td style="text-align: center;"><input type="checkbox"/> 2</td> <td style="text-align: center;"><input type="checkbox"/> 2</td> <td>Incorporated and Principal Place of Business in Another State</td> <td style="text-align: center;"><input type="checkbox"/> 5</td> <td style="text-align: center;"><input type="checkbox"/> 5</td> </tr> <tr> <td>Citizen or Subject of a Foreign Country</td> <td style="text-align: center;"><input type="checkbox"/> 3</td> <td style="text-align: center;"><input type="checkbox"/> 3</td> <td>Foreign Nation</td> <td style="text-align: center;"><input type="checkbox"/> 6</td> <td style="text-align: center;"><input type="checkbox"/> 6</td> </tr> </table>		PTF	DEF		PTF	DEF	Citizen of This State	<input type="checkbox"/> 1	<input type="checkbox"/> 1	Incorporated or Principal Place of Business in this State	<input type="checkbox"/> 4	<input type="checkbox"/> 4	Citizen of Another State	<input type="checkbox"/> 2	<input type="checkbox"/> 2	Incorporated and Principal Place of Business in Another State	<input type="checkbox"/> 5	<input type="checkbox"/> 5	Citizen or Subject of a Foreign Country	<input type="checkbox"/> 3	<input type="checkbox"/> 3	Foreign Nation	<input type="checkbox"/> 6	<input type="checkbox"/> 6
	PTF	DEF		PTF	DEF																				
Citizen of This State	<input type="checkbox"/> 1	<input type="checkbox"/> 1	Incorporated or Principal Place of Business in this State	<input type="checkbox"/> 4	<input type="checkbox"/> 4																				
Citizen of Another State	<input type="checkbox"/> 2	<input type="checkbox"/> 2	Incorporated and Principal Place of Business in Another State	<input type="checkbox"/> 5	<input type="checkbox"/> 5																				
Citizen or Subject of a Foreign Country	<input type="checkbox"/> 3	<input type="checkbox"/> 3	Foreign Nation	<input type="checkbox"/> 6	<input type="checkbox"/> 6																				

IV. ORIGIN (Place an X in one box only.)

1 Original Proceeding
 2 Removed from State Court
 3 Remanded from Appellate Court
 4 Reinstated or Reopened
 5 Transferred from another district (specify):
 6 Multi-District Litigation
 7 Appeal to District Judge from Magistrate Judge

V. REQUESTED IN COMPLAINT: **JURY DEMAND:** Yes No (Check 'Yes' only if demanded in complaint.)

CLASS ACTION under F.R.C.P. 23: Yes No **MONEY DEMANDED IN COMPLAINT:** \$ 100,000+

VI. CAUSE OF ACTION (Cite the U.S. Civil Statute under which you are filing and write a brief statement of cause. Do not cite jurisdictional statutes unless diversity.)

Patent Infringement

VII. NATURE OF SUIT (Place an X in one box only.)

OTHER STATUTES <input type="checkbox"/> 400 State Reapportionment <input type="checkbox"/> 410 Antitrust <input type="checkbox"/> 430 Banks and Banking <input type="checkbox"/> 450 Commerce/ICC Rates/etc. <input type="checkbox"/> 460 Deportation <input type="checkbox"/> 470 Racketeer Influenced and Corrupt Organizations <input type="checkbox"/> 480 Consumer Credit <input type="checkbox"/> 490 Cable/Sat TV <input type="checkbox"/> 810 Selective Service <input type="checkbox"/> 850 Securities/Commodities/Exchange <input type="checkbox"/> 875 Customer Challenge 12 USC 3410 <input type="checkbox"/> 890 Other Statutory Actions <input type="checkbox"/> 891 Agricultural Act <input type="checkbox"/> 892 Economic Stabilization Act <input type="checkbox"/> 893 Environmental Matters <input type="checkbox"/> 894 Energy Allocation Act <input type="checkbox"/> 895 Freedom of Info. Act <input type="checkbox"/> 900 Appeal of Fee Determination Under Equal Access to Justice <input type="checkbox"/> 950 Constitutionality of State Statutes	CONTRACT <input type="checkbox"/> 110 Insurance <input type="checkbox"/> 120 Marine <input type="checkbox"/> 130 Miller Act <input type="checkbox"/> 140 Negotiable Instrument <input type="checkbox"/> 150 Recovery of Overpayment & Enforcement of Judgment <input type="checkbox"/> 151 Medicare Act <input type="checkbox"/> 152 Recovery of Defaulted Student Loan (Excl. Veterans) <input type="checkbox"/> 153 Recovery of Overpayment of Veteran's Benefits <input type="checkbox"/> 160 Stockholders' Suits <input type="checkbox"/> 190 Other Contract <input type="checkbox"/> 195 Contract Product Liability <input type="checkbox"/> 196 Franchise REAL PROPERTY <input type="checkbox"/> 210 Land Condemnation <input type="checkbox"/> 220 Foreclosure <input type="checkbox"/> 230 Rent Lease & Ejectment <input type="checkbox"/> 240 Torts to Land <input type="checkbox"/> 245 Tort Product Liability <input type="checkbox"/> 290 All Other Real Property	TORTS PERSONAL INJURY <input type="checkbox"/> 310 Airplane <input type="checkbox"/> 315 Airplane Product Liability <input type="checkbox"/> 320 Assault, Libel & Slander <input type="checkbox"/> 330 Fed. Employers' Liability <input type="checkbox"/> 340 Marine <input type="checkbox"/> 345 Marine Product Liability <input type="checkbox"/> 350 Motor Vehicle <input type="checkbox"/> 355 Motor Vehicle Product Liability <input type="checkbox"/> 360 Other Personal Injury <input type="checkbox"/> 362 Personal Injury-Med Malpractice <input type="checkbox"/> 365 Personal Injury-Product Liability <input type="checkbox"/> 368 Asbestos Personal Injury Product Liability IMMIGRATION <input type="checkbox"/> 462 Naturalization Application <input type="checkbox"/> 463 Habeas Corpus-Alien Detainee <input type="checkbox"/> 465 Other Immigration Actions	TORTS PERSONAL PROPERTY <input type="checkbox"/> 370 Other Fraud <input type="checkbox"/> 371 Truth in Lending <input type="checkbox"/> 380 Other Personal Property Damage <input type="checkbox"/> 385 Property Damage Product Liability BANKRUPTCY <input type="checkbox"/> 422 Appeal 28 USC 158 <input type="checkbox"/> 423 Withdrawal 28 USC 157 CIVIL RIGHTS <input type="checkbox"/> 441 Voting <input type="checkbox"/> 442 Employment <input type="checkbox"/> 443 Housing/Accommodations <input type="checkbox"/> 444 Welfare <input type="checkbox"/> 445 American with Disabilities - Employment <input type="checkbox"/> 446 American with Disabilities - Other <input type="checkbox"/> 440 Other Civil Rights	PRISONER PETITIONS <input type="checkbox"/> 510 Motions to Vacate Sentence <input type="checkbox"/> 530 Habeas Corpus General <input type="checkbox"/> 535 Death Penalty <input type="checkbox"/> 540 Mandamus/Other <input type="checkbox"/> 550 Civil Rights <input type="checkbox"/> 555 Prison Condition FORFEITURE / PENALTY <input type="checkbox"/> 610 Agriculture <input type="checkbox"/> 620 Other Food & Drug <input type="checkbox"/> 625 Drug Related Seizure of Property 21 USC 881 <input type="checkbox"/> 630 Liquor Laws <input type="checkbox"/> 640 R.R. & Truck <input type="checkbox"/> 650 Airline Regs <input type="checkbox"/> 660 Occupational Safety /Health <input type="checkbox"/> 690 Other	LABOR <input type="checkbox"/> 710 Fair Labor Standards Act <input type="checkbox"/> 720 Labor/Mgmt. Relations <input type="checkbox"/> 730 Labor/Mgmt. Reporting & Disclosure Act <input type="checkbox"/> 740 Railway Labor Act <input type="checkbox"/> 790 Other Labor Litigation <input type="checkbox"/> 791 Empl. Ret. Inc. Security Act PROPERTY RIGHTS <input type="checkbox"/> 820 Copyrights <input checked="" type="checkbox"/> 830 Patent <input type="checkbox"/> 840 Trademark SOCIAL SECURITY <input type="checkbox"/> 861 HIA (1395ff) <input type="checkbox"/> 862 Black Lung (923) <input type="checkbox"/> 863 DIWC/DIWW (405(g)) <input type="checkbox"/> 864 SSID Title XVI <input type="checkbox"/> 865 RSI (405(g)) FEDERAL TAX SUITS <input type="checkbox"/> 870 Taxes (U.S. Plaintiff or Defendant) <input type="checkbox"/> 871 IRS-Third Party 26 USC 7609
---	--	--	---	--	--

CV12-07382

FOR OFFICE USE ONLY: Case Number _____

AFTER COMPLETING THE FRONT SIDE OF FORM CV-71, COMPLETE THE INFORMATION REQUESTED BELOW.

**UNITED STATES DISTRICT COURT, CENTRAL DISTRICT OF CALIFORNIA
CIVIL COVER SHEET**

VIII(a). IDENTICAL CASES: Has this action been previously filed in this court and dismissed, remanded or closed? No Yes
If yes, list case number(s): _____

VIII(b). RELATED CASES: Have any cases been previously filed in this court that are related to the present case? No Yes
If yes, list case number(s): _____

Civil cases are deemed related if a previously filed case and the present case:

- (Check all boxes that apply) A. Arise from the same or closely related transactions, happenings, or events; or
 B. Call for determination of the same or substantially related or similar questions of law and fact; or
 C. For other reasons would entail substantial duplication of labor if heard by different judges; or
 D. Involve the same patent, trademark or copyright, and one of the factors identified above in a, b or c also is present.

IX. VENUE: (When completing the following information, use an additional sheet if necessary.)

(a) List the County in this District; California County outside of this District; State if other than California; or Foreign Country, in which **EACH** named plaintiff resides.
 Check here if the government, its agencies or employees is a named plaintiff. If this box is checked, go to item (b).

County in this District:*	California County outside of this District; State, if other than California; or Foreign Country
	Delaware

(b) List the County in this District; California County outside of this District; State if other than California; or Foreign Country, in which **EACH** named defendant resides.
 Check here if the government, its agencies or employees is a named defendant. If this box is checked, go to item (c).

County in this District:*	California County outside of this District; State, if other than California; or Foreign Country
	Nevada

(c) List the County in this District; California County outside of this District; State if other than California; or Foreign Country, in which **EACH** claim arose.
Note: In land condemnation cases, use the location of the tract of land involved.

County in this District:*	California County outside of this District; State, if other than California; or Foreign Country
All claims - Los Angeles	

* Los Angeles, Orange, San Bernardino, Riverside, Ventura, Santa Barbara, or San Luis Obispo Counties

Note: In land condemnation cases, use the location of the tract of land involved

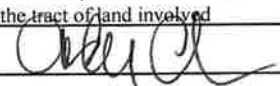
X. SIGNATURE OF ATTORNEY (OR PRO PER):  Date 8/27/2012

Notice to Counsel/Parties: The CV-71 (JS-44) Civil Cover Sheet and the information contained herein neither replace nor supplement the filing and service of pleadings or other papers as required by law. This form, approved by the Judicial Conference of the United States in September 1974, is required pursuant to Local Rule 3-1 is not filed but is used by the Clerk of the Court for the purpose of statistics, venue and initiating the civil docket sheet. (For more detailed instructions, see separate instructions sheet.)

Key to Statistical codes relating to Social Security Cases:

Nature of Suit Code	Abbreviation	Substantive Statement of Cause of Action
861	HIA	All claims for health insurance benefits (Medicare) under Title 18, Part A, of the Social Security Act, as amended. Also, include claims by hospitals, skilled nursing facilities, etc., for certification as providers of services under the program. (42 U.S.C. 1935FF(b))
862	BL	All claims for "Black Lung" benefits under Title 4, Part B, of the Federal Coal Mine Health and Safety Act of 1969. (30 U.S.C. 923)
863	DIWC	All claims filed by insured workers for disability insurance benefits under Title 2 of the Social Security Act, as amended; plus all claims filed for child's insurance benefits based on disability. (42 U.S.C. 405(g))
863	DIWW	All claims filed for widows or widowers insurance benefits based on disability under Title 2 of the Social Security Act, as amended. (42 U.S.C. 405(g))
864	SSID	All claims for supplemental security income payments based upon disability filed under Title 16 of the Social Security Act, as amended.
865	RSI	All claims for retirement (old age) and survivors benefits under Title 2 of the Social Security Act, as amended. (42 U.S.C. (g))