

1
2
3
4
5
6
7
8
9
10
11
12
13
14
15
16
17
18
19
20
21
22
23
24
25
26

UNITED STATES DISTRICT COURT
WESTERN DISTRICT OF WASHINGTON
AT SEATTLE

ICI USA LLC, a Washington limited liability company,

Plaintiff,

v.

TEXIM TRADING COMPANY, and
IPERFECT KITCHEN,

Defendants.

Case No. _____

COMPLAINT FOR PATENT, TRADE
DRESS, AND COPYRIGHT
INFRINGEMENT

JURY DEMAND

ICI USA LLC hereby states its complaint against Texim Trading Company and iPerfect Kitchen as follows:

I. PARTIES

1. Plaintiff ICI USA LLC (“ICI”) is a Washington company with its principal place of business in Seattle, Washington. ICI develops unique, innovative products that solve everyday problems, including sphere ice molds.

2. Upon information and belief, Defendant Texim Trading Company maintains its principal place of business in San Diego, California.

3. Upon information and belief, Texim Trading Company does business as, or owns and/or controls, iPerfect Kitchen. Upon information and belief, Defendants sell a

1 sphere ice mold.

2 **II. JURISDICTION AND VENUE**

3 4. This Court has subject matter jurisdiction under 28 U.S.C. § 1331 and § 1332.

4 5. This Court has personal jurisdiction because Defendants commit intentional
5 acts to sell its products in the stream of commerce in the forum state; they have sufficient
6 minimum contacts with the forum state; they specifically sell their infringing product in the
7 forum state; they sell their infringing product through an Internet site requiring active
8 participation in the forum state; and they maintain a universal presence through Internet sales
9 in the forum state.

10 6. Venue is proper under 28 U.S.C. §§ 1391(b)(2) and 1400(b) because a
11 substantial part of the events giving rise to the claim occurred in this judicial district, and the
12 property that is the subject of this action, namely, the Tovolo sphere ice mold, was created,
13 designed, and sold in this judicial district. In addition, Defendants sold infringing products in
14 this judicial district.
15

16 **III. FACTUAL ALLEGATIONS**

17 **A. ICI Has Sold Over One Million of Its Innovative and Well-Known
18 Sphere Ice Molds.**

19 7. ICI designs innovative new products that surprise and delight the user. ICI
20 has built a team of experts dedicated to each phase of product development including
21 marketers, industrial and graphic designers, and packaging experts. ICI's clients include
22 Bed Bath & Beyond, Crate & Barrel, Pier 1 Imports, Sur La Table, Macy's, and Williams
23 Sonoma, among others, all of whom sell the ICI products.
24

25 8. One of ICI's well known product lines is the Tovolo product line. ICI uses
26

1 the Tovolo brand to market utensils, kitchen gadgets, and beverage devices including tea
2 infusers, ice cube trays, wine bottle holders, crock book holders, spreaders, scoops, pizza
3 wheels, and ice sphere molds, among many other successful products.

4
5 9. The Tovolo products all have a certain look and feel in terms of design. The
6 Tovolo products incorporate bright colors; high-quality, sturdy-looking plastics; professional
7 quality-looking designs; and unique shapes. The designs among products look similar and
8 help customers identify products that are part of the Tovolo line of products.

9
10 10. The Tovolo product line includes a product called Sphere Ice Molds. The
11 innovative and clever design produces an ice sphere, which melts slowly when added to a
12 drink.

13
14 11. ICI sells the Tovolo sphere ice molds through Amazon.com among other
15 places. The product received 4.6 out of 5 stars on Amazon after being reviewed by over
16 2100 customers. The Tovolo sphere ice mold is a best seller on Amazon.com and among the
17 Top 100 products in Kitchen & Dining. The product is the “#1 Best Seller” out of all the ice
18 cube molds and trays sold on Amazon.com.

19
20 12. In addition, ICI sells the Tovolo sphere ice mold through Bed Bath & Beyond,
21 Sur La Table, and Williams Sonoma in addition to other fine retailers.

22
23 13. In total, ICI has sold over one million Tovolo sphere ice molds through its
24 various retailers.

25
26 14. Since its creation, the Tovolo sphere ice mold has featured a unique design
and combination of design elements. This design and trade dress includes a clear plastic
mold base with two swirled-looking lines with the Tovolo trademark in the middle and a

1 gray plastic mold top with grooves, lines, ridges, and a wagon wheel design. The colors and
2 design elements help the mold look ready for professional kitchen use. None of these design
3 elements are functional or necessary to the mold in any manner; rather, they add a unique
4 touch similar to all of the other Tovolo products. Because these design elements fit in the
5 family of the other Tovolo products, they help to signify the source of the products.
6

7 **B. Defendants’ “ICE SPHERE MOLD” Ice Mold Infringes the**
8 **Tovolo Product.**

9 15. On or about June 9, 2015, the Defendants’ “Ice Sphere Mold” was purchased
10 from Amazon.com and delivered to the offices of Schwabe, Williamson, & Wyatt located in
11 Seattle, Washington. *See Attachment A.*

12 16. Defendants also sell the infringing ice sphere molds through, at a minimum,
13 online sales, including websites such as hot-bar-supplies.com. *See Attachment B.*

14 17. Defendants’ Ice Sphere Molds are sold on the website and Amazon.com, see
15 **Attachment C**, copies and infringes the trade dress of the Tovolo sphere ice molds.
16

17 **Tovolo Product**



iPerfect Product



24 18. In addition to infringing the trade dress of Tovolo’s product, the packaging for
25 iPerfect Kitchen’s brand product infringes on the trade dress of the Tovolo packaging.
26

1 iPerfect Kitchen’s brand packaging uses the same rectangular box, similar black, gray, and
2 white color scheme, and very similar wording placement. Further, just like the Tovolo
3 product packaging, the front of the brand packaging displays a cocktail glass that is partially
4 filled with a brown liquid and a large ice sphere. iPerfect Kitchen’s Ice Sphere Molds brand
5 packaging also displays the words “for classic cocktails,” which invokes Tovolo’s use of
6 those same words on its packaging.
7

8 **Tovolo Product**



iPerfect Product

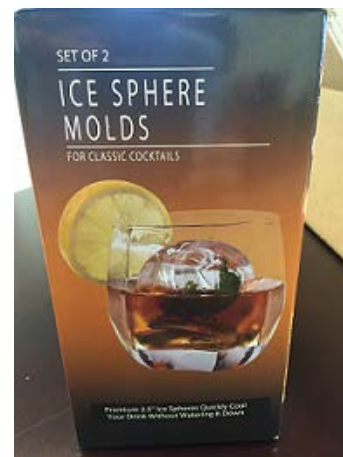

19. In addition, iPerfect Kitchen’s brand product infringes the copyright of ICI’s operating instructions on the reverse side of the packaging. The Tovolo packaging includes unique instructions including six step-by-step images demonstrating the proper use of the sphere ice mold, along with six accompanying written instructions with each image. The reverse side of the iPerfect Kitchen product packaging copies the exact same six images that appear on the Tovolo product packing. The instructional words are also nearly identical. The only difference is that the iPerfect Kitchen instructions omit the word “silicone” when referring to the product’s cap; otherwise the instructions are copied verbatim.

Tovolo Product

iPerfect Product

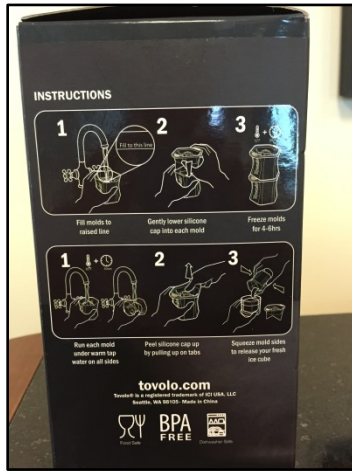

IV. CLAIMS FOR RELIEF

CAUSE OF ACTION – PATENT INFRINGEMENT UNDER 35 U.S.C. § 271

20. ICI repeats, realleges, and incorporates all of the above allegations.

21. On June 9, 2015, US D731,264 (the “264 Patent”), entitled “Sphere Mold,” attached hereto as **Attachment D**, was issued to ICI.

22. The ‘264 Patent is presumed valid.

23. Defendants’ Ice Sphere Mold is infringing the ‘264 Patent, at least Fig. 1, 2, 3, 4, 5, 8, 9 of the ‘264 product.

24. Defendants manufacture, sell, and distribute the infringing product.

25. Defendants’ actions have damaged ICI.

CAUSE OF ACTION – TRADE DRESS INFRINGEMENT UNDER 15 U.S.C. § 1125(a)

26. ICI repeats, realleges, and incorporates all of the above allegations.

27. ICI owns a protectable trade dress in the clearly articulated design elements and combination of elements in the Tovolo sphere ice mold, including a clear plastic mold

1 base that features two swirled-looking lines with the Tovolo trademark in the middle and a
2 gray plastic mold top with grooves, lines, ridges, and a wagon wheel design. ICI also owns a
3 protectable trade dress in the Tovolo sphere ice mold packaging, including the color scheme,
4 tag lines and placement, and layout elements.

5
6 28. None of the trade dress in the Tovolo sphere ice mold or packaging is
7 functional. Rather, the design elements and combination thereof were selected to fit in with
8 the other products in Tovolo's kitchen and beverage lines and to designate Tovolo and ICI as
9 the source. Indeed, the Tovolo trademark is incorporated into the trade dress of the product
10 and packaging as another way to indicate the product source.

11
12 29. The trade dress in the Tovolo sphere ice mold and packaging is inherently
13 distinctive or has acquired secondary meaning through ICI's sales and marketing efforts of
14 the mold as described above. The product and packaging design and features are well known
15 in all of the markets in which ICI sells the products.

16
17 30. Defendants' ice sphere mold design and packaging together create a
18 likelihood of confusion as to source, sponsorship, affiliation, connection, or association
19 because the Defendants' product and packaging copies all of the non-functional trade dress
20 elements of the Tovolo sphere ice mold product and packaging. Customers are likely to be
21 confused or deceived as to the origination of the Defendants' product or are likely to think
22 that the Defendants' product is somehow connected to or associated with ICI and Tovolo.

23
24 31. The general impression made by the Defendants' product upon the eye of the
25 ordinary purchaser or user is deceiving given the similarity to the Tovolo trade dress. The
26 multiplicity of similarities between the products constitutes trade dress infringement.

32. Defendants' conduct violates section 1125(a) and has damaged ICI.

CAUSE OF ACTION – COPYRIGHT INFRINGEMENT UNDER 17 U.S.C. § 501

33. ICI repeats, realleges, and incorporates all of the above allegations.

34. ICI owns a protectable copyright in the compilation of instructions, including unique images and words, and the manner in which these instructions are set forth on the Tovolo packaging.

35. The iPerfect Kitchen product copies the instructional images as they are presented on the Tovolo packaging.

36. The iPerfect Kitchen product substantially copies the instructional words as they are presented on the Tovolo packaging.

37. Defendants' conduct violates 17 U.S.C. § 501 and has damaged ICI.

V. PRAYER FOR RELIEF

WHEREFORE, Plaintiff ICI prays for relief as follows:

1. For a judgment against Defendant;
2. For an injunction against Defendant that prohibits Defendant from manufacturing, selling, incorporating, or otherwise using ICI's proprietary trade dress.
3. For damages against Defendants in an amount to be determined at trial;
4. For reasonable attorneys' fees and the costs of pursuing ICI's claims as may be allowed by law; and;
5. Such other and further relief as the Court determines is just and proper.

1 Dated this 24th day of June, 2015.

2 SCHWABE, WILLIAMSON & WYATT, P.C.

3
4 By: s/ Priya Sinha Cloutier
5 Priya Sinha Cloutier, WSBA #37407
6 Email: pcloutier@schwabe.com
7 1420 5th Avenue, Suite 3400
8 Seattle, WA 98101-4010
9 *Attorneys for Plaintiff ICI USA LLC*

10
11 By: s/ Ryan W. Dumm
12 Ryan W. Dumm, WSBA #46738
13 Email: rdumm@schwabe.com
14 1420 5th Avenue, Suite 3400
15 Seattle, WA 98101-4010
16 *Attorneys for Plaintiff ICI USA LLC*

ATTACHMENT A

amazon.com



SDnzdMzMk

Your order of June 9, 2015 (Order ID 103-6412454-6381059)

Qty.	Item	Item Price	Total
1	Tovolo Colossal Cube Ice Mold - Set of 2, Kitchen (** P-9-A098A439 **) B00BMANKMW 848113002586	\$14.22	\$14.22
1	Zappbo® - MORE FOR LESS 4 X 2.5" Huge Perfect Ice Balls Value for Money Best Silicone Ice Sphere Maker and Ice Ball Mold... (** P-8-A259C034 **) X000RT8VND B00H3ZH7CO - SKU8 820103774178 (Sold by Zappbo)	\$15.99	\$15.99
1	iPerfect Kitchen Sphere Ice Mold - Premium Silicone Ice Ball Maker - Set of 2 X 2.5" Molds Kitchen (** P-8-A204A416 **) B00V500FYU RV-H9FK-NNP7 616241764870 (Sold by iPerfect Kitchen)	\$8.95	\$8.95

This shipment completes your order.	Subtotal	\$39.16
Have feedback on how we packaged your order? Tell us at www.amazon.com/packaging.	Tax Collected	\$1.37
	Order Total	\$40.53
	Paid via credit/debit	\$40.53
	Balance due	\$0.00

Returns Are Easy! Most items can be refunded, exchanged, or replaced when returned in original and unopened condition. Visit <http://www.amazon.com/returns> to start your return, or <http://www.amazon.com/help> for more information on return policies.



ATTACHMENT B



SEARCH... SEARCH

0 ITEMS

HOME BLOG BEST SELLERS SPECIAL OFFERS CONTACT US

HOME / BARWARE

KITCHEN & DINING

BARWARE TOOL SETS (214)

COCKTAIL SHAKERS (134)

BARWARE (119)

GLASSWARE & DRINKWARE (145)

SHOT GLASSES (141)

ICE CUBE MOLDS & TRAYS (136)

WINE ACCESSORY SETS (199)

JIGGERS (124)

MUDDLERS (119)

BOTTLE OPENERS (142)

COOKBOOKS, FOOD & WINE

I PERFECT KITCHEN SPHERE ICE MOLD - PREMIUM SILICONE ICE BALL MAKER - SET OF 2 X 2.5" MOLDS

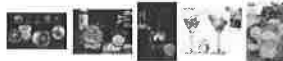

PRICE: \$20.95 \$15.95

AS OF: 2015-06-24 03:33:57 CDT (MORE INFO)

YOU SAVE: \$5.00 (31%)

AVAILABILITY: IN STOCK

ADD TO CART

USUALLY SHIPS IN 24 HOURS

PRODUCT INFORMATION (MORE INFO)



SEE ALL USER REVIEWS

VIEW PRODUCT DETAILS

READ AMAZON PRODUCT REVIEWS

MANUFACTURER DESCRIPTION

THE SECRET TO AN IMMACULATE COCKTAIL, WHISKEY, OR SCOTCH LIES IN COOLING THE SPIRITS WITHOUT DILUTING THE DELICATE FLAVORS - FAST, EASY & FUN

• ARE YOU SIMPLY EXHAUSTED OF USING REGULAR ICE CUBES TO KEEP THE DRINKS LAST COLD

ATTACHMENT C

amazon Try Prime All iperfect kitchen ice sphere Q INTRODUCING amazon echo 

Shop by Department Your Amazon.com Today's Deals Gift Cards Sell Help Hello, Sign in Your Account Try Prime Wish List 0 Cart

Kitchen & Dining Best Sellers Wedding Registry Small Appliances Kitchen Tools Cookware Bakeware Cutlery Dining & Entertaining

[Back to search results for "iperfect kitchen ice sphere"](#)



Roll over image to zoom in

iPerfect Kitchen Sphere Ice Mold - Premium Silicone Ice Ball Maker - Set of 2 X 2.5" Molds

by iPerfect Kitchen
 ☆☆☆☆☆ - 1,111 customer reviews

List Price: ~~\$29.95~~
 Price: ~~\$15.95~~
 Sale: \$10.95 & FREE Shipping on orders over \$35.
 Details
 You Save: \$19.00 (63%)

In Stock.
 Sold by iPerfect Kitchen and Fulfilled by Amazon. Gift-wrap available.

Want it TODAY, June 23? Order within 1 hr 9 mins and choose **Same-Day Delivery** at checkout. Details

- ✓ AWESOME GIFTS OR PRESENTS FOR ANY COCKTAIL PARTY ENTHUSIAST, MIXOLOGIST, OR PROFESSIONAL BARTENDER - Your Award winning Sphere Ice Mold comes with FREE 150 Classic Cocktails & Tropical Drink Recipes eBook will be e-Mailed directly to you - Limited Stock! Trusted by thousands of Happy Customers on Amazon and over 800 positive product reviews ! BUY with CONFIDENCE: we offer a Money Back Guarantee if you do not love this product !
- ✓ PERFECT ROUND BETTER THAN CUBES - Ice Balls keep drinks colder for longer and won't dilute drinks like conventional ice cubes do - Ice Spheres are UNIQUE cause they have the Lowest Surface Area, so the ice melts slowly - Giving you an exquisitely chilled drink without the watery taste - Spherical Ice is frequently used in Bars and Upscale Restaurant, Pool Party !
- ✓ EASY-TO-USE & INGENIOUS ICE SPHERES DESIGN - Perfectly Set of 2 x 2.5 " Ice Rounds are sleek enough to slot inside pretty much any freezer - Features "Fill To Line" and "Leak-free" - Work as Tovolo Molds - BPA Free, FDA Approved, Durable, Dishwasher Safe & Easy to Clean - Flexible Silicone Iceballmaker for easy release of Ice Balls - Flat Bottom Design Won't Tip Over - You will be able to create beverage chillers that highlight your mixologist skills, even if only pouring a scotch or whiskey for yourself or who you love !
- ✓ SURPRISE FRIEND & FAMILY WITH A SPARKLING 2.5" ICE SPHERES FLOATING IN THEIR DRINK - The days of inefficient ice cube trays that warp, crack, spill, and leak are over! Ice Rounds allow you to endlessly create and customise: it's bound to be a hit with the kids! Filling Ice Baller with punch or juice for a delicious, fruity treat? Using berries, lemon slices, or mint to give your ice balls which a bit of panache? - For men, womens, dad, mom: why not have a shot of vodka, with a cranberry juice ice sphere? It's just made a perfectly deconstructed Cape Cod - Mojito or Margarita with a lime juice infused ice ball? Enhance your lemonade, sweet tea? Or even just add a bit of fruit juice to flavor your water naturally while you keep it cold? HAVING FUN exploring the endless beverages possibilities !
- ✓ THE ONLY SPHERE ICE MOLDS WITH A 100% SATISFACTION LIFETIME MONEY-BACK GUARANTEE - One of the top-talked-about and must-have kitchen gadget of the 21st century, this is the best ideal for anyone who love Tumbler, Punch Bowls, Water Pitchers, Mason Jars, Goblets,

Share    

Qty: 1 

Yes, I want **FREE Two-Day Shipping** with Amazon Prime

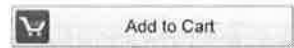

Turn on 1-Click ordering for this browser

Ship to:
 WA 98101 

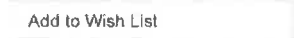



Have one to sell? 

Ad feedback 

ATTACHMENT D



US00D731264S

(12) **United States Design Patent** (10) **Patent No.:** **US D731,264 S**
Frank et al. (45) **Date of Patent:** **** Jun. 9, 2015**

(54) **SPHERE MOLD** 2,028,808 A * 1/1936 Rosenthal 428/36.8
 2,152,467 A 3/1939 Crosby
 2,247,018 A 6/1941 Henning
 (Continued)

(71) Applicant: **ICI USA, LLC**, Seattle, WA (US)

(72) Inventors: **Matthew Frank**, Seattle, WA (US);
Ryan H Peloquin, Seattle, WA (US)

(73) Assignee: **ICI USA, LLC**, Seattle, WA (US)

(**) Term: **14 Years**

(21) Appl. No.: **29/452,215**

(22) Filed: **Apr. 12, 2013**

Related U.S. Application Data

(63) Continuation of application No. 29/417,609, filed on Apr. 5, 2012, now abandoned.

(51) **LOC (10) Cl.** **07-04**

(52) **U.S. Cl.**
 USPC **D7/672**

(58) **Field of Classification Search**

USPC D7/368, 603, 672-676, 638, 669, 323, D7/354, 376, 543-546, 549, 555, 601-602, D7/677, 681, 701, 705, 708; 249/63, 69, 249/70, 127, 132, 81, 91-92, 118-121, 249/94-97, 126, 173, 175; 62/135, 348, 62/352, 350, 300, 66, 228.2, 250, 312, 62/398, 400, 459; D15/80, 89-90, 82-83; D1/101-103, 105; D23/200, 202, D23/204-206; 425/117, 118, 125, 126.1, 425/126.2, 234; 294/87.11; 206/563, 423, 206/822; 220/659, 669, 674-675, 220/FOR. 112, FOR. 115, 800; D6/329, 351
 See application file for complete search history.

(56) **References Cited**

U.S. PATENT DOCUMENTS

D42,547 S 5/1912 Smith
 1,034,580 A * 8/1912 Buckau 425/408

OTHER PUBLICATIONS

4pcs Ice Brick Mold Party Bar Tray Cube Round Sphere Ball Maker Mould Kitchen—ebay, (online), retrieved on Apr. 29, 2013. Retrieved from, URL: <http://www.ebay.com/itm/ws/eBay>.

(Continued)

Primary Examiner — Wan Laymon

Assistant Examiner — Mark Booker

(74) *Attorney, Agent, or Firm* — Schwabe Williamson & Wyatt PC

(57) **CLAIM**

I claim as my invention the ornamental design for a sphere mold, as shown and described.

DESCRIPTION

FIG. 1 shows a perspective view of the sphere mold;
 FIG. 2 shows a first, side view of the sphere mold when it is in a closed position where the opposite side is to the same as the side shown;
 FIG. 3 shows a top of the sphere mold when it is in a closed position;
 FIG. 4 shows a second side view of the sphere mold when it is in a closed position where the opposite side is the same as the to the side shown;
 FIG. 5 shows a top view of the sphere mold when it is in an open position;
 FIG. 6 is a side view of the sphere mold when it is in a closed position;
 FIG. 7 is a sectional view of the sphere mold taken from line 7-7 of FIG. 6;
 FIG. 8 is an exploded view of the sphere mold; and,
 FIG. 9 is a bottom view of the sphere mold.

1 Claim, 8 Drawing Sheets

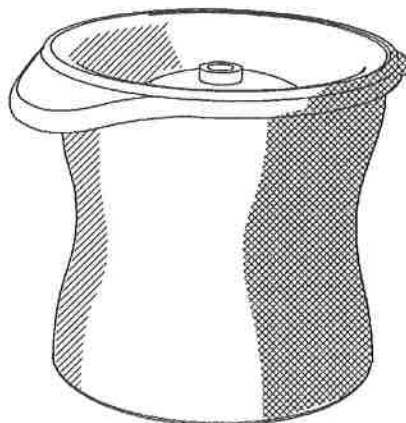

US D731,264 S

Page 2

(56)

References Cited

U.S. PATENT DOCUMENTS

2,839,209	A *	6/1958	Lester et al.	215/13.1	D648,989	S	11/2011	Coursey et al.	
2,890,122	A *	6/1959	Katon	426/112	8,046,921	B2	11/2011	Mastroianni	
D187,748	S *	4/1960	Bently	D7/674	D661,540	S *	6/2012	Facey	D7/354
2,955,044	A	10/1960	Tupper		8,408,016	B2	4/2013	Mccollough et al.	
2,980,039	A	4/1961	Jolly		D687,681	S *	8/2013	Barber	D7/674
3,050,207	A *	8/1962	Oxenham	220/581	2009/0088273	A1	4/2009	Nardacci et al.	
3,181,913	A *	5/1965	Guido et al.	297/462	2010/0162577	A1	7/2010	Chen	
3,199,711	A *	8/1965	Nurkiewicz	220/581	2012/0237656	A1	9/2012	Henry	
3,204,959	A *	9/1965	Nicholls	473/610	2014/0197300	A1 *	7/2014	Zorovich et al.	249/127
3,287,807	A	11/1966	Menke						
4,075,264	A	2/1978	Hay, II						
4,076,207	A	2/1978	Austin						
4,130,619	A	12/1978	Held						
4,157,805	A	6/1979	Haber et al.						
4,284,399	A	8/1981	Newcomb et al.						
4,320,849	A	3/1982	Yellin						
4,959,903	A	10/1990	Daoust et al.						
D348,473	S *	7/1994	Griffin, Sr.	D15/90					
5,527,012	A	6/1996	Vinkel et al.						
5,937,525	A	8/1999	Chan						
D432,874	S	10/2000	Kari						
D504,286	S *	4/2005	de Cleir	D7/675					
D521,819	S	5/2006	So et al.						

OTHER PUBLICATIONS

Tovolo Sphere Ice Molds—Sur la table, (online), product reviewed on Sep. 14, 2012, retrieved on Apr. 29, 2013. Retrieved from, URL: <http://www.surlatable.com/product/PR0-958470-10>.

Tovolo Sphere Ice Molds, Set of 2—Amazon, (online), reviewed on May 3, 2012, retrieved on Apr. 29, 2013. Retrieved from, URL: <http://www.amazon.com/Tovolo-Sphere-Ice-Mold/>.

Tovolo Square Ice Cube Maker 2 1/4" Diameter Ice Cubes for Cocktails—ebay, (online), site updated on Mar. 13, 2013, retrieved Apr. 29, 2013. URL: <http://ebay.com/itm/ws/eBayISAPI>.

Office Action dated May 10, 2013 for Design U.S. Appl. No. 29/417,609 (priority application); pp. 1-10.

* cited by examiner

U.S. Patent

Jun. 9, 2015

Sheet 1 of 8

US D731,264 S

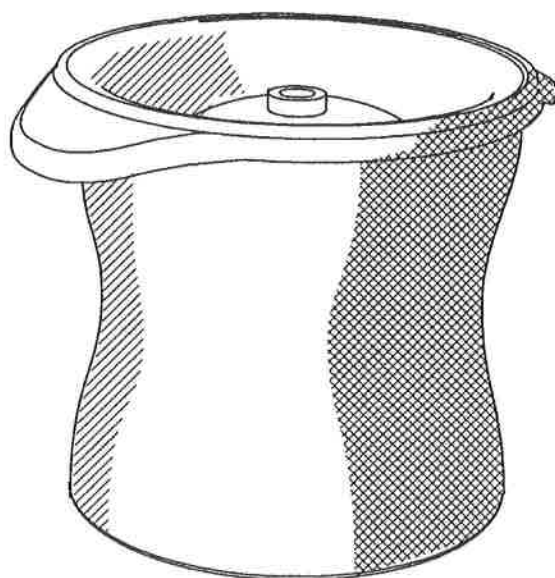

FIG 1

U.S. Patent

Jun. 9, 2015

Sheet 2 of 8

US D731,264 S

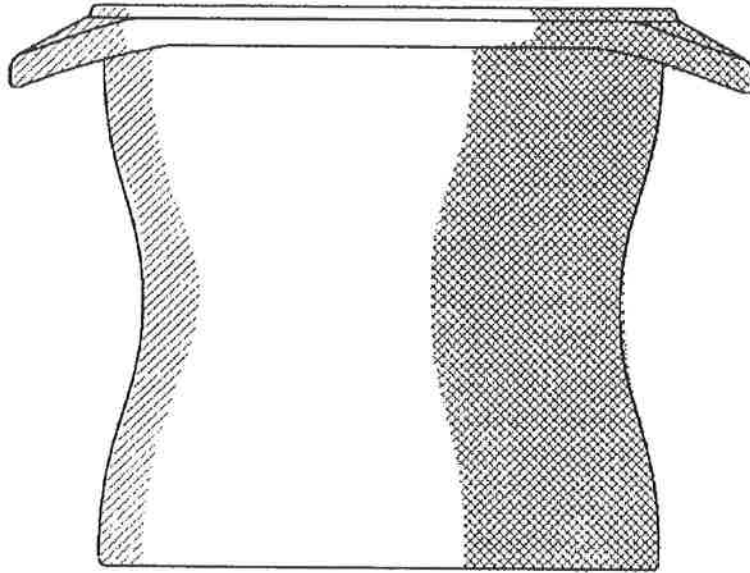

FIG 2

U.S. Patent

Jun. 9, 2015

Sheet 3 of 8

US D731,264 S

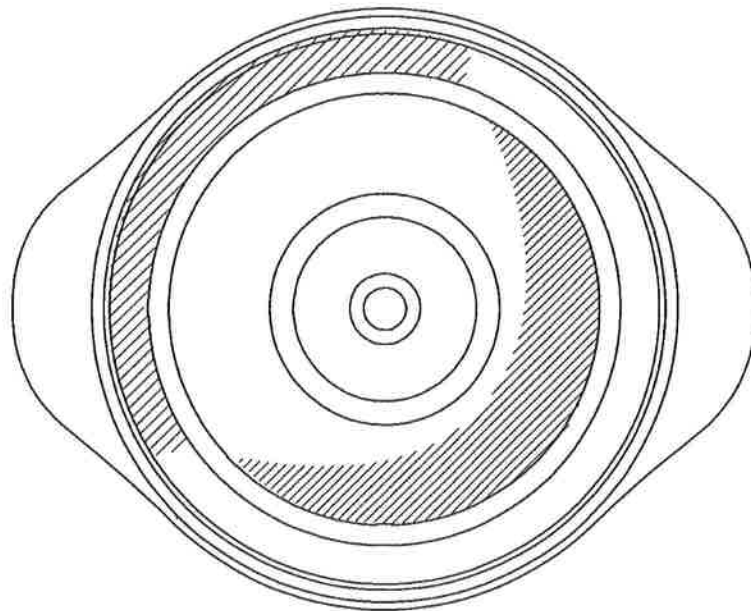

FIG 3

U.S. Patent

Jun. 9, 2015

Sheet 4 of 8

US D731,264 S

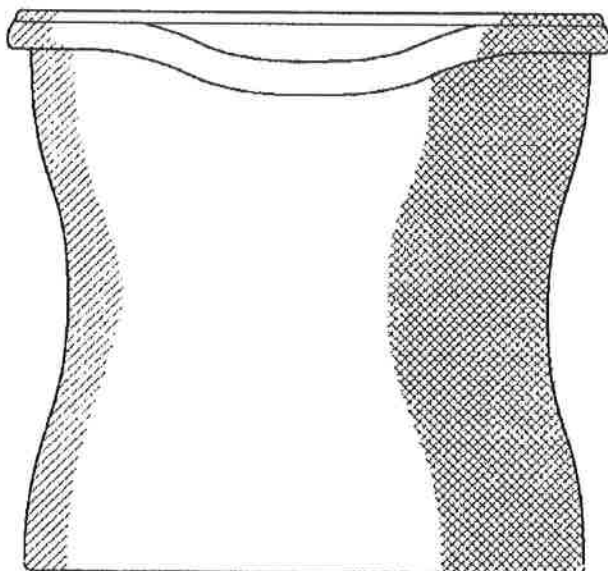

FIG 4

U.S. Patent

Jun. 9, 2015

Sheet 5 of 8

US D731,264 S

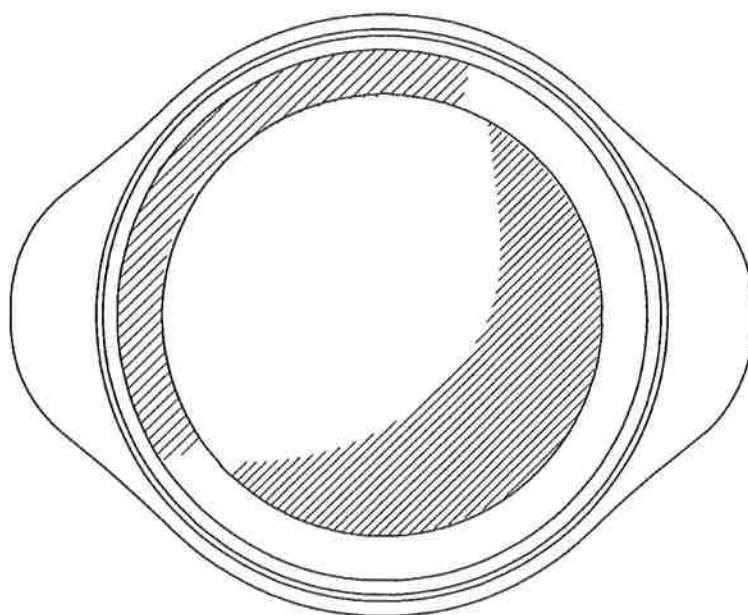

FIG 5

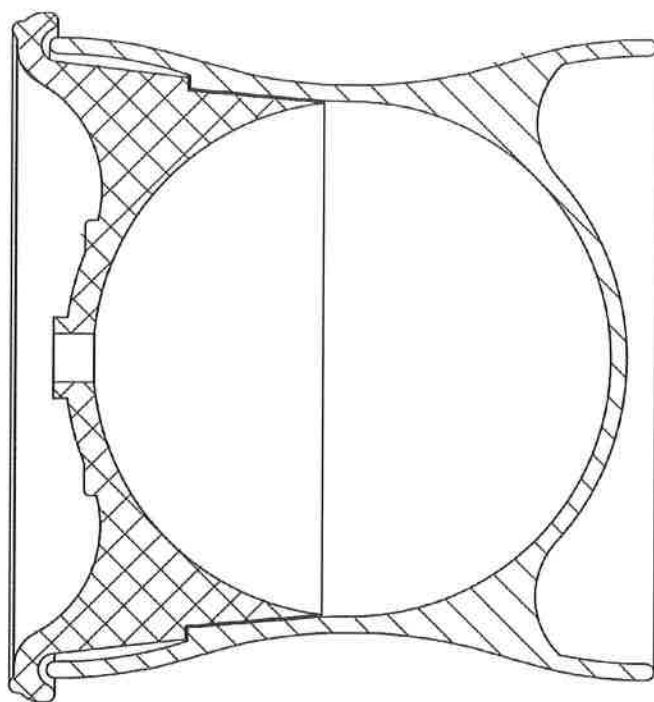

FIG 7

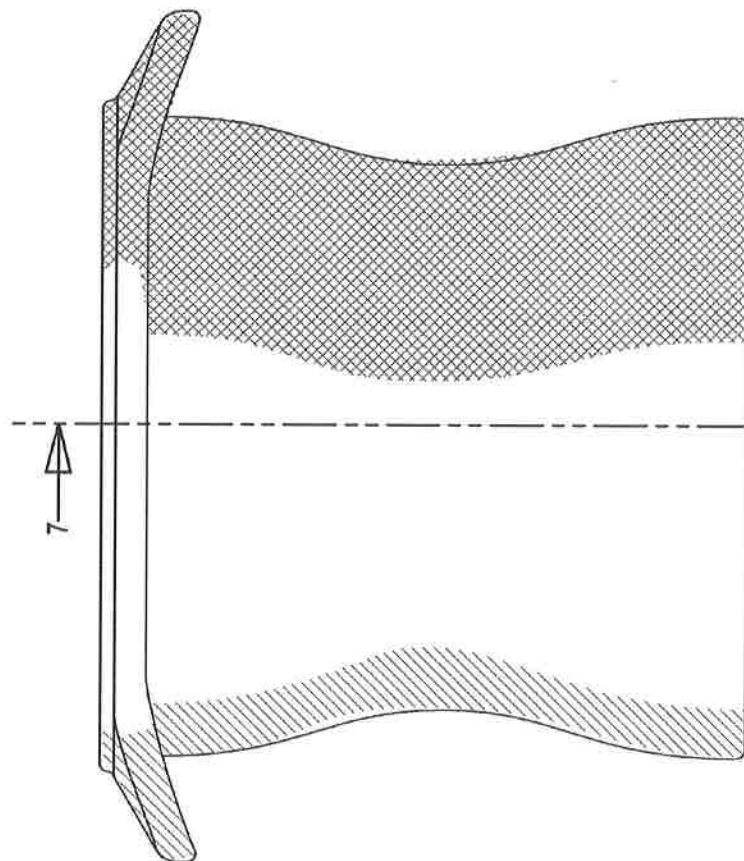

FIG 6

U.S. Patent

Jun. 9, 2015

Sheet 7 of 8

US D731,264 S

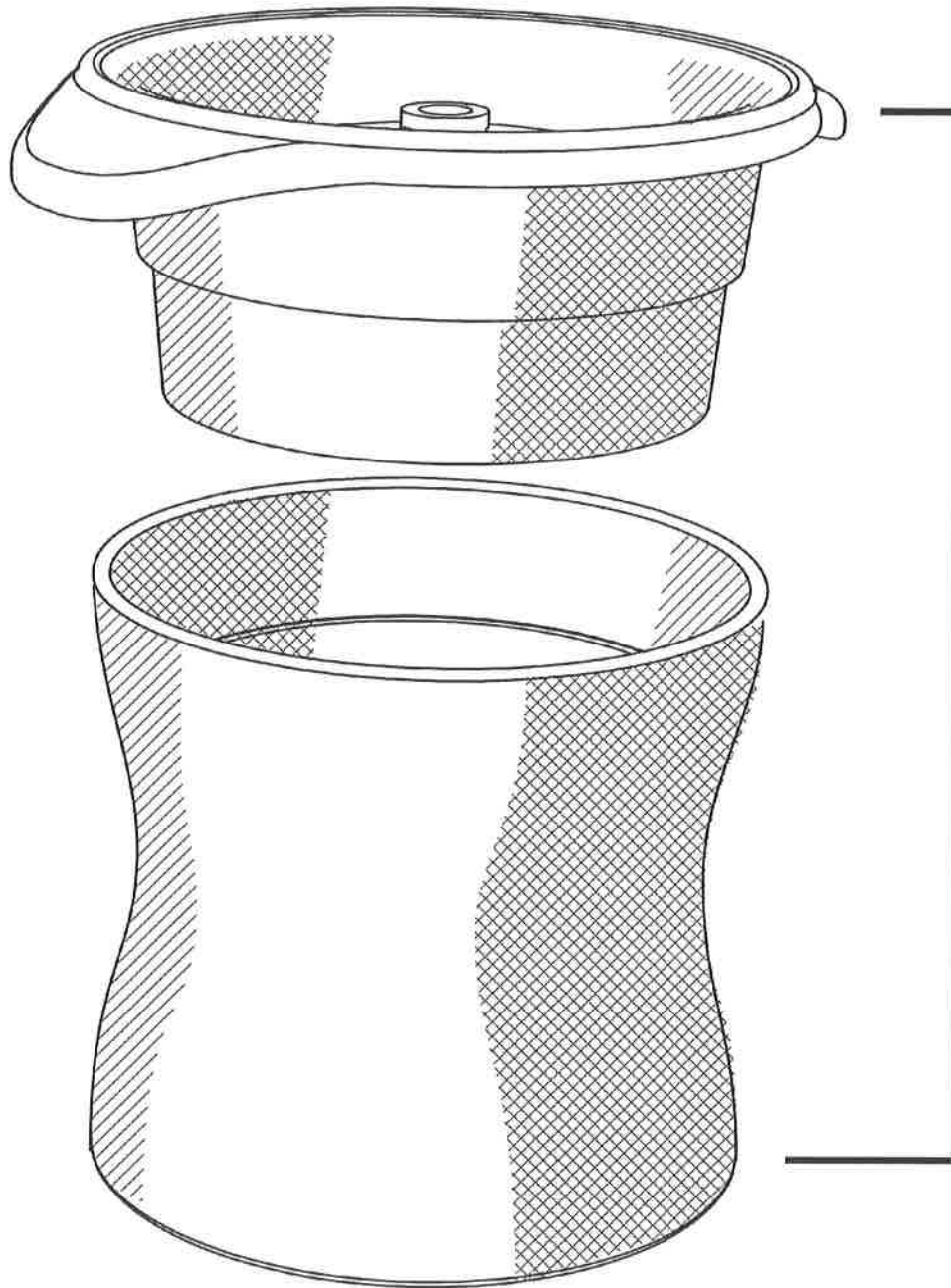

FIG 8

U.S. Patent

Jun. 9, 2015

Sheet 8 of 8

US D731,264 S

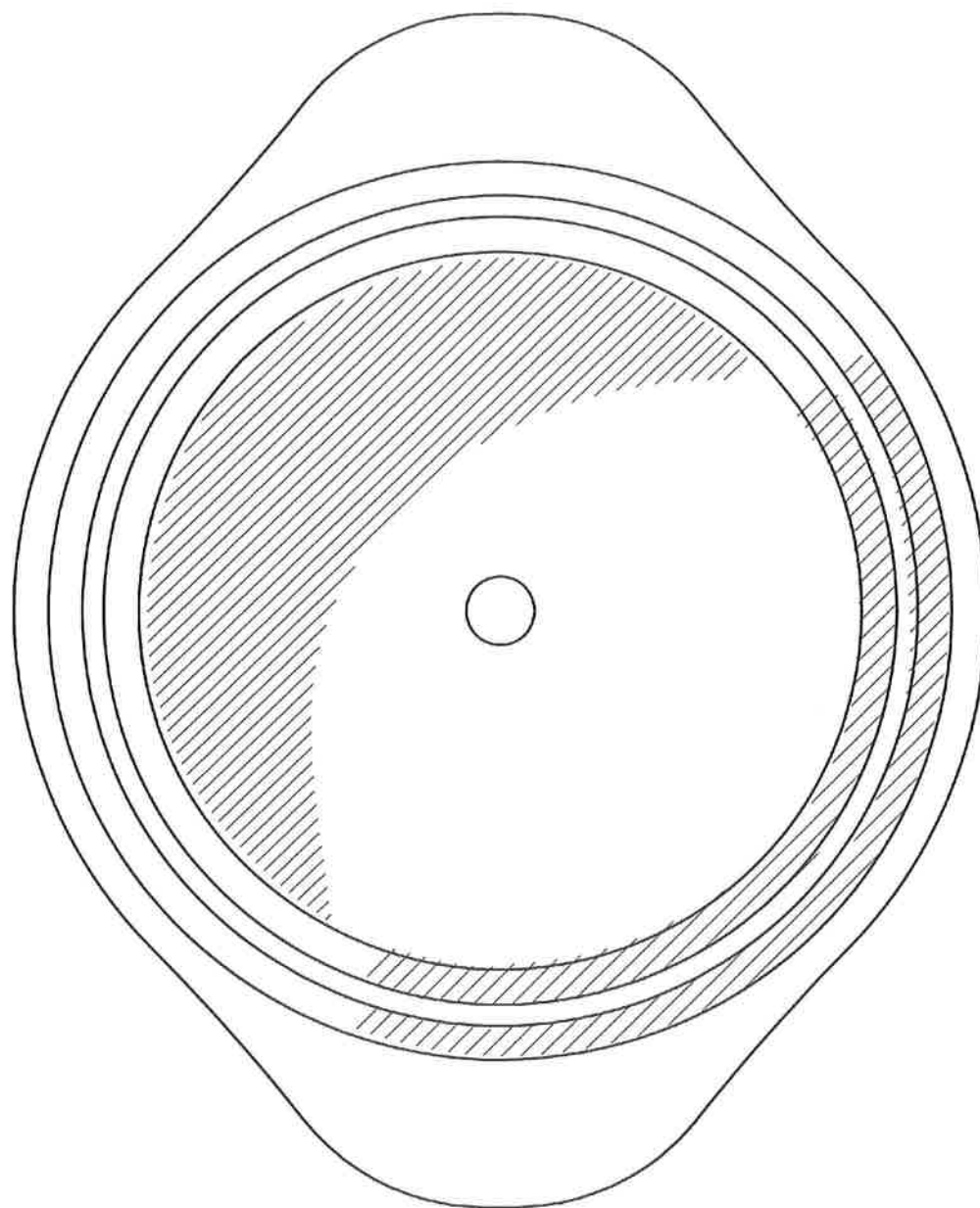

FIG 9