

1 Rasheed McWilliams (SBN 281832)

2 Rasheed@cotmanip.com

3 Daniel C. Cotman (SBN 218315)

4 dan@cotmanip.com

5 Obi I. Iloputaife (SBN 192271)

6 obi@cotmanip.com

7 COTMAN IP LAW GROUP, PLC

8 35 Hugus Alley, Suite 210

9 Pasadena, CA 91103

10 (626) 405-1413/FAX: (626) 316-7577

11 *Attorneys for Plaintiff*

12 *Shipping & Transit LLC*

13 **UNITED STATES DISTRICT COURT**

14 **CENTRAL DISTRICT OF CALIFORNIA**

15 Shipping & Transit LLC,

) Case No. 2:16-cv-06531

16 Plaintiff,

)

) **COMPLAINT FOR PATENT**
) **INFRINGEMENT AND**
) **PERMANENT INJUNCTION**

17 v.

)

18 Lighthouse.io Inc., a corporation; Inlight
19 Labs Pty Ltd, an Australian corporation,

)

) **DEMAND FOR JURY TRIAL**

20 Defendant.

)

)

)

)

)

)

)

21 _____
22 ///

23 ///

24 ///

25

26

27

28

1 Plaintiff Shipping & Transit LLC, (“S&T”), by and through its undersigned
2 counsel, for its Complaint against Defendants Lighthouse.io Inc. and Inlight Labs Pty
3 Ltd. (collectively, “Lighthouse”) makes the following allegations. These allegations
4 are made upon information and belief.

5 **NATURE OF THE ACTION**

6 1. This is an action to stop Defendant’s infringement of United States Patent
7 Nos. 6,317,060 (“the ‘060 Patent”) and 6,415,207 (“the ‘207 Patent”).

8 **THE PARTIES**

9 2. Shipping & Transit LLC, formerly known as ArrivalStar S.A. and Melvino
10 Technologies Limited, is a limited liability company organized under the laws of the
11 State of Florida having an office and principal place of business at 711 SW 24th Ave.,
12 Boynton Beach, Florida 33435.

13 3. Lighthouse.io Inc. is a Delaware corporation with a principal place of
14 business at 20 Jay Street, Suite 312, Brooklyn, New York 11201.

15 4. Inlight Labs Pty Ltd is an Australian private company with a principal
16 place of business at 47 Easey Street, Collingwood VIC 3066.

17 **JURISDICTION AND VENUE**

18 5. This patent infringement action arises under the patent laws of the United
19 States including 35 U.S.C. §§ 271, et seq.

20 6. This Court has subject-matter jurisdiction over this action pursuant to 28
21 U.S.C. § § 1331 and 1338(a) because it arises under United States Patent law.

22 7. This Court has personal jurisdiction over the Defendant because they
23 (either directly or through their subsidiaries, divisions, groups or divisions) have
24 sufficient minimum contacts with the forum as a result of business conducted within
25 the State of California and this district; and/or specifically over the Defendant (either
26 directly or through their subsidiaries, divisions, groups or distributors) because of
27 their infringing conduct within or directed at the State of California and this district.
28

1 8. Venue is proper in this district pursuant to 28 U.S.C. §1391(b) and
2 1400(b).

3 **FACTS**

4 1. S&T is the owner, by assignment, of United States Patent No. 6,317,060
5 (“the ‘060 Patent”), entitled, “Base Station System and Method for Monitoring Travel
6 of Mobile Vehicles and Communicating Notification Messages,” which was duly and
7 legally issued by the United States Patent and Trademark Office (“USPTO”) on
8 November 13, 2001. A true and correct copy of the ‘060 Patent is attached as **Exhibit**
9 **A** to this complaint.

10 2. S&T is the owner, by assignment, of United States Patent No. 6,415,207
11 (“the ‘207 Patent”), entitled, “System and Method for Automatically Providing
12 Vehicle Status Information,” which was duly and legally issued by the USPTO on
13 July 2, 2002. A true and correct copy of the ‘207 Patent is attached as **Exhibit B** to
14 this complaint.

15 3. S&T is owner of all rights, titles and interests in and to the ‘060 Patent
16 and the ‘207 Patent (collectively, “Patents-In-Suit”) including the right to assert all
17 causes of action arising from the infringement of the Patents-in-Suit and the right to
18 all damages, past and present, for any infringement of the Patents-in-Suit.

19 4. The claims of the Patents-In-Suit are valid and enforceable.

20 5. Lighthouse’s Logistics and Asset Management System is a computer based
21 notification system for notifying users of impending arrivals of vehicles at particular
22 locations. The system stores vehicle identity, location information, time information
23 and other data on a plurality of vehicles. The system selects and monitors portions of
24 data to determine when notifications are expected to occur, during the time when
25 vehicles are active, at preset timed intervals. The system determines when notifications
26 should occur and or be triggered based preset criteria. See below illustration.
27
28

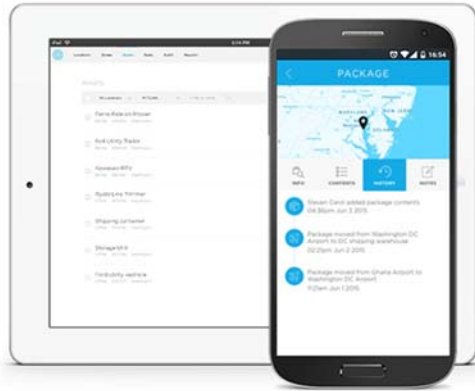

Digitize your workflow

Replace manual or paper-based manifests with dynamic forms presented at the right time, right place, and to the right employee.

- Create digital manifests and assign to cargo and locations
- Trigger list presentation on arrival at a location
- Authorize delivery and verify receipt with a single click from your mobile device
- Track asset or inventory with real time dashboards and digital history reports
- Enable personnel to report issues and order new supplies

6. Lighthouse monitors shipments from pickup locations, travel and hub locations and also delivery locations. The system monitors and provides shipment notifications, and updated tracking information and reports status of vehicles picking up, transporting and delivering customer ordered products. The system provides updated vehicle delivery information; it communicates with the user's device when the user logs in to the system. The user's device is a remote communication device. The system utilizes the customer identification information to automatically provide customers with shipment status information. The system automatically retrieves vehicle status information upon the customer logging into their account and automatically transmits the retrieved status information to the customer.

7. Defendants offer the Lighthouse Accused Product, Logistics and Asset Management System, to its customers in the United States.

8. At a minimum, the Lighthouse Accused Product has all the elements of at least claim 10 of the '207 and claim 19 of the '060 patents. See **Exhibit C**.

///

///

///

///

///

COUNT I

CLAIM FOR PATENT INFRINGEMENT

UNDER 35 U.S.C. § 271 ('207 PATENT)

9. S&T Technologies realleges and incorporates by reference the allegations of the preceding paragraphs of this Complaint as if fully set forth herein.

10. Without license or authorization and in violation of 35 U.S.C. §271(a), Lighthouse has infringed and continues to infringe Claim 10 of '207 Patent by making, using, offering for sale and/or selling within this district and elsewhere in the United States the Lighthouse Accused Products. See **Exhibit C**.

11. Unless enjoined by this Court, Defendant will continue to infringe the '207 Patent.

12. As a direct and proximate result of Defendant's infringement of the '207 Patent, S&T has been and will continue to be damaged in an amount yet to be determined, including but not limited to Plaintiff's lost profits and/or reasonable royalties.

COUNT II

CLAIM FOR PATENT INFRINGEMENT

UNDER 35 U.S.C. § 271 ('060 PATENT)

13. S&T Technologies realleges and incorporates by reference the allegations of the preceding paragraphs of this Complaint as if fully set forth herein.

14. Without license or authorization and in violation of 35 U.S.C. §271(a), Lighthouse has infringed and continues to infringe Claim 19 of '060 Patent by making, using, offering for sale and/or selling within this district and elsewhere in the United States the Lighthouse Accused Products. See **Exhibit C**.

15. Unless enjoined by this Court, Defendant will continue to infringe the '060 Patent.

16. As a direct and proximate result of Defendant's infringement of the '060 Patent, S&T has been and will continue to be damaged in an amount yet to be

1 determined, including but not limited to Plaintiff's lost profits and/or reasonable
2 royalties.

3 **PRAYER FOR RELIEF**

4 WHEREFORE, Plaintiff prays for relief against Defendant as follows:

5 1. In favor of Plaintiff that Defendant has infringed each of the asserted
6 claims of the '207 Patent and the '060 Patent;

7 2. Requiring Defendant to pay Plaintiff its damages, costs, expenses, and pre-
8 judgment and post-judgment interest for Defendant's infringement each of the asserted
9 claims of the '207 Patent and the '060 Patent as provided under 35 U.S.C § 284; but not
10 less than a reasonable royalty; and

11 3. For such other and further relief as may be just and equitable.

12 **DEMAND FOR TRIAL BY JURY**

13 Pursuant to Rule 38 of the Federal Rules of Civil Procedure, Plaintiff hereby
14 demands a jury trial on all issues and causes of action triable to a jury.

15 Respectfully submitted,

16
17 DATED: August 30, 2016

COTMAN IP LAW GROUP, PLC

s/Rasheed M. McWilliams

19 By: _____

Rasheed M. McWilliams

Daniel C. Cotman

Obi I. Iloputaife

COTMAN IP LAW GROUP, PLC

35 Hugus Alley, Suite 210

Pasadena, CA 91103

(626) 405-1413/FAX: (626) 316-7577

Attorneys for Plaintiff

Shipping & Transit LLC



US006317060B1

(12) **United States Patent**
Jones

(10) **Patent No.:** **US 6,317,060 B1**
 (45) **Date of Patent:** ***Nov. 13, 2001**

(54) **BASE STATION SYSTEM AND METHOD FOR MONITORING TRAVEL OF MOBILE VEHICLES AND COMMUNICATING NOTIFICATION MESSAGES**

4,791,571	12/1988	Takahashi et al.	701/117
4,799,162	1/1989	Shinkawa et al.	701/117
4,804,937	2/1989	Barbiaux et al.	340/459
4,812,843	3/1989	Champion, III et al.	340/905
4,857,925 *	8/1989	Brubaker	340/994

(75) Inventor: **Martin Kelly Jones**, Vancouver (CA)

(List continued on next page.)

(73) Assignee: **Global Research Systems, Inc.**, Rome, GA (US)

FOREIGN PATENT DOCUMENTS

(*) Notice: This patent issued on a continued prosecution application filed under 37 CFR 1.53(d), and is subject to the twenty year patent term provisions of 35 U.S.C. 154(a)(2).

2 559 930	8/1985	(FR) .
2674355	9/1992	(FR) .
52066175	6/1977	(JP) .
63288400	11/1988	(JP) .

Subject to any disclaimer, the term of this patent is extended or adjusted under 35 U.S.C. 154(b) by 0 days.

Primary Examiner—Benjamin C. Lee

(74) *Attorney, Agent, or Firm*—Thomas, Kayden, Horstemeier & Risley, LLP

(21) Appl. No.: **09/516,577**

(22) Filed: **Mar. 1, 2000**

Related U.S. Application Data

(60) Provisional application No. 60/122,482, filed on Mar. 1, 1999.

(51) **Int. Cl.**⁷ **G08G 1/123**

(52) **U.S. Cl.** **340/994; 340/989; 340/993; 701/204**

(58) **Field of Search** 340/994, 982, 340/989, 990, 991, 995, 906, 907, 539, 993; 701/204, 205, 206, 207, 208, 302

(56) **References Cited**

U.S. PATENT DOCUMENTS

Re. 35,920	10/1998	Sorden et al.	342/457
4,220,946	9/1980	Henriot	340/994
4,713,661	12/1987	Boone et al.	340/994

(57) **ABSTRACT**

A vehicle monitoring and notification system includes a route handler, a schedule monitor, and a communication handler. The schedule monitor determines when users should receive notification messages based on data that indicates when vehicles are expected to arrive at certain locations. The route handler communicates with vehicle control units on board vehicles to determine whether and how much any of the vehicles are off schedule. If any of the vehicles are off schedule, the route handler updates the data monitored by the schedule monitor to change when the schedule monitor determines that notification messages should be received by the users. Once the schedule monitor determines that a user should receive a notification message, the schedule monitor transmits a notification request to the communication handler. The communication handler then establishes communication with a communication device associated with the user and transmits a notification message to the user. Therefore, the user is warned of an impending arrival of a vehicle at a particular location.

23 Claims, 11 Drawing Sheets

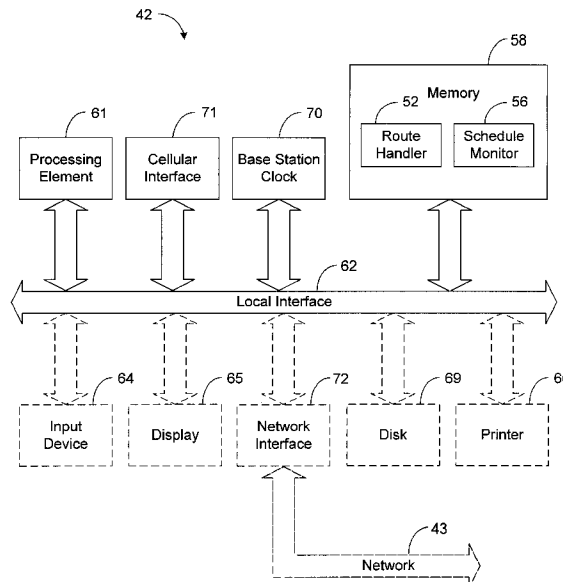

US 6,317,060 B1

Page 2

U.S. PATENT DOCUMENTS

4,956,777	9/1990	Cearley et al.	401/24	5,544,225	8/1996	Kennedy, III et al.	455/412
5,006,847	* 4/1991	Rush et al.	340/994	5,546,444	8/1996	Roach, Jr. et al.	455/412
5,014,206	5/1991	Scribner et al.	701/207	5,587,715	12/1996	Lewis	342/357.03
5,068,656	11/1991	Sutherland	340/989	5,594,650	1/1997	Shah et al.	701/207
5,122,959	6/1992	Nathanson et al.	701/117	5,602,739	2/1997	Haagenstad et al.	701/117
5,131,020	7/1992	Liebesny et al.	455/427	5,623,260	4/1997	Jones	340/994
5,168,451	* 12/1992	Bolger	701/117	5,648,770	7/1997	Ross	340/994
5,218,629	6/1993	Dumond, Jr. et al.	455/572	5,652,707	7/1997	Wortham	455/456
5,223,844	6/1993	Mansell et al.	342/357.07	5,657,010	8/1997	Jones	340/994
5,243,529	* 9/1993	Kashiwazaki	701/208	5,668,543	9/1997	Jones	340/994
5,299,132	3/1994	Wortham	455/457	5,673,305	9/1997	Ross	455/577
5,351,194	9/1994	Ross et al.	455/456	5,719,771	2/1998	Buck et al.	455/456
5,381,338	1/1995	Wysocki et al.	701/207	5,724,243	3/1998	Westerlage et al.	455/456
5,400,020	3/1995	Jones	340/994	5,736,940	4/1998	Burgener	340/994
5,440,489	* 8/1995	Newman	701/20	5,739,774	4/1998	Olandesi	340/994
5,444,444	8/1995	Ross	340/994	5,751,245	5/1998	Janky et al.	342/357.07
5,461,374	10/1995	Lewiner et al.	340/994	5,760,742	6/1998	Branch et al.	342/457
5,483,234	* 1/1996	Carreel	340/994	5,771,455	6/1998	Kennedy, III et al.	455/456
5,483,454	* 1/1996	Lewiner et al.	701/200	5,808,565	9/1998	Matta et al.	340/994
5,493,295	2/1996	Lewiner et al.	340/994	5,987,377	* 11/1999	Westerlage et al.	701/204
5,493,694	2/1996	Vlcek et al.	455/521	6,006,159	12/1999	Schmier et al.	701/200
5,515,421	5/1996	Sikand et al.	379/88.21	6,134,501	10/2000	Oumi	701/209
5,519,621	5/1996	Wortham	455/99	6,137,425	* 10/2000	Oster et al.	340/994
5,539,810	7/1996	Kennedy, III et al.	379/88.25	6,178,378	* 1/2001	Leibold	701/202

* cited by examiner

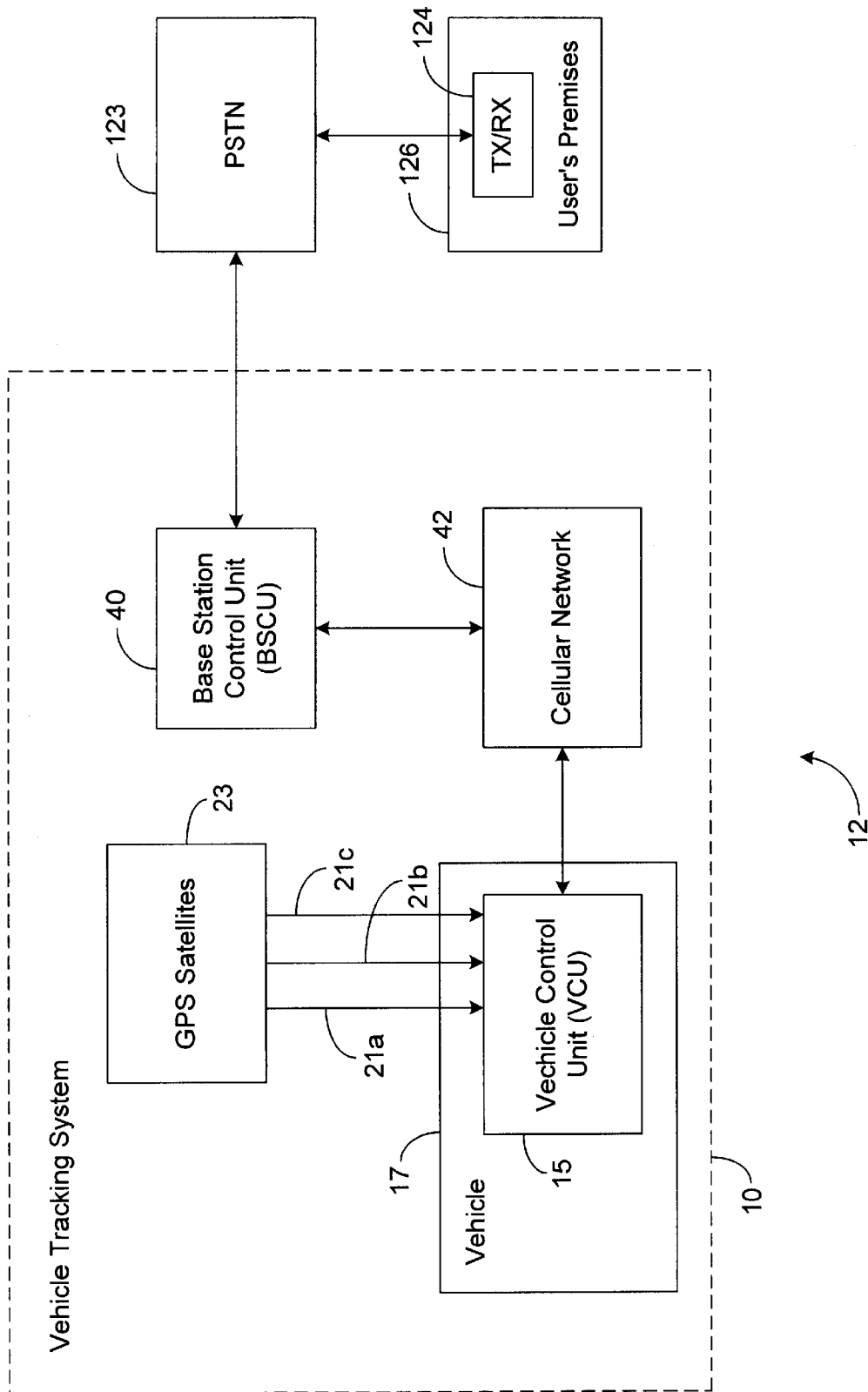

Fig. 1

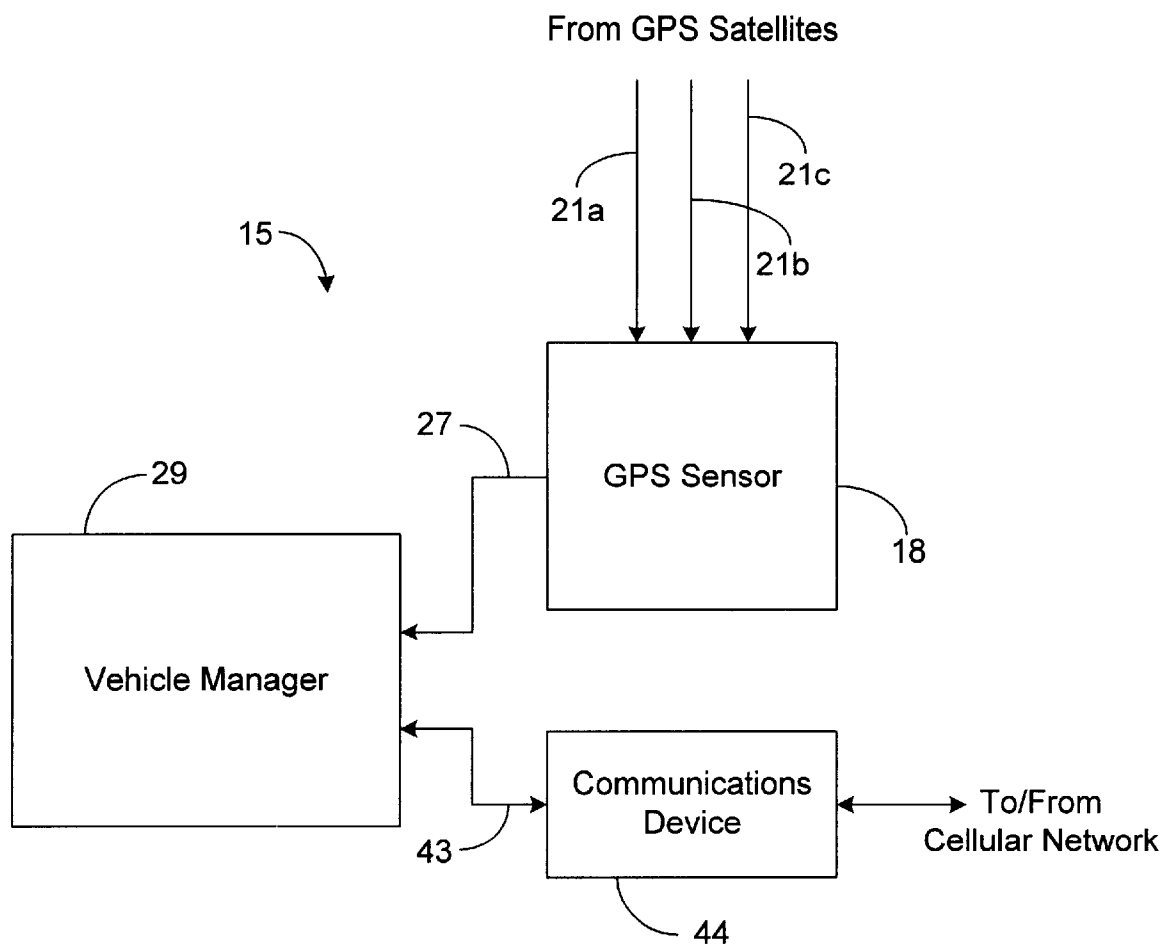

Fig. 2

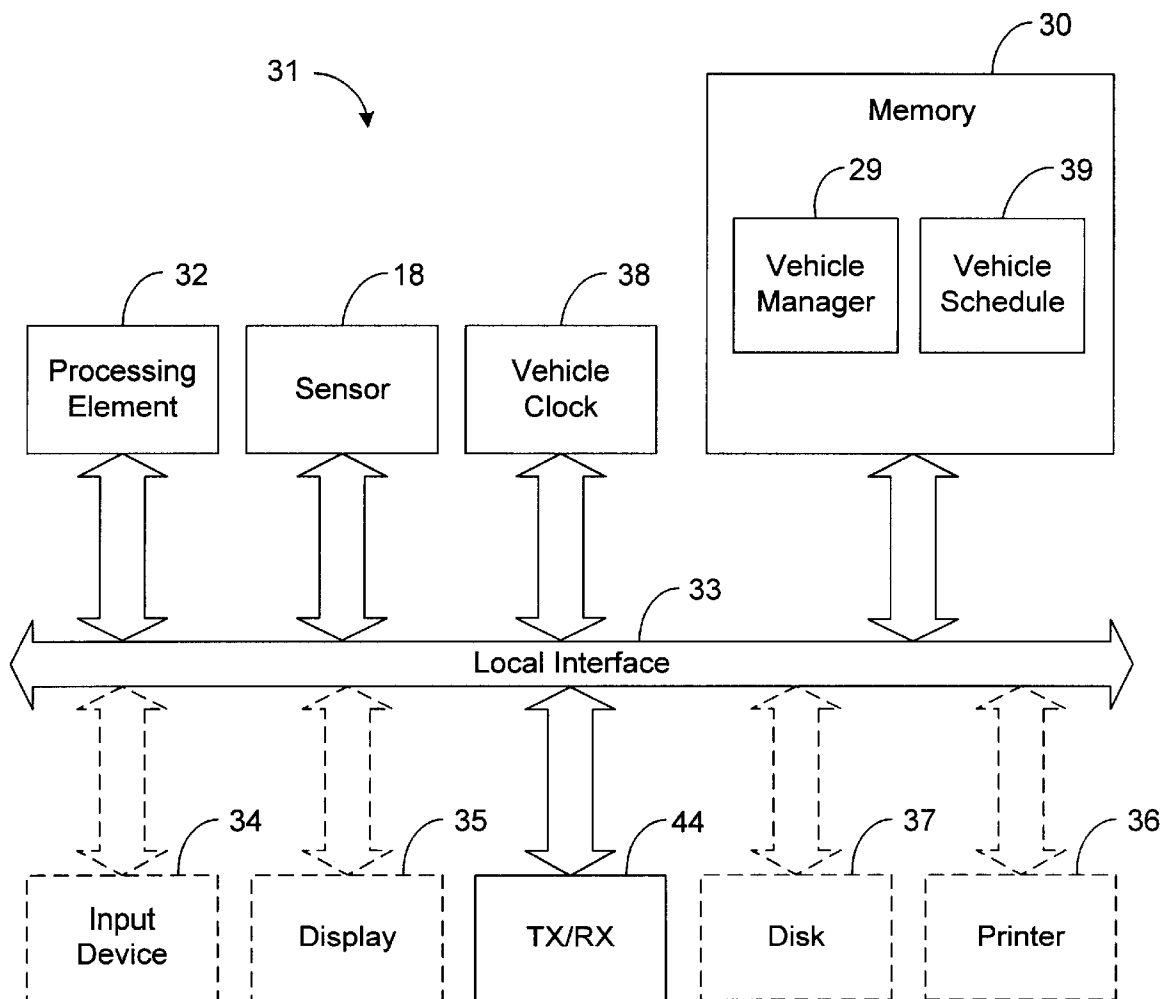

Fig. 3

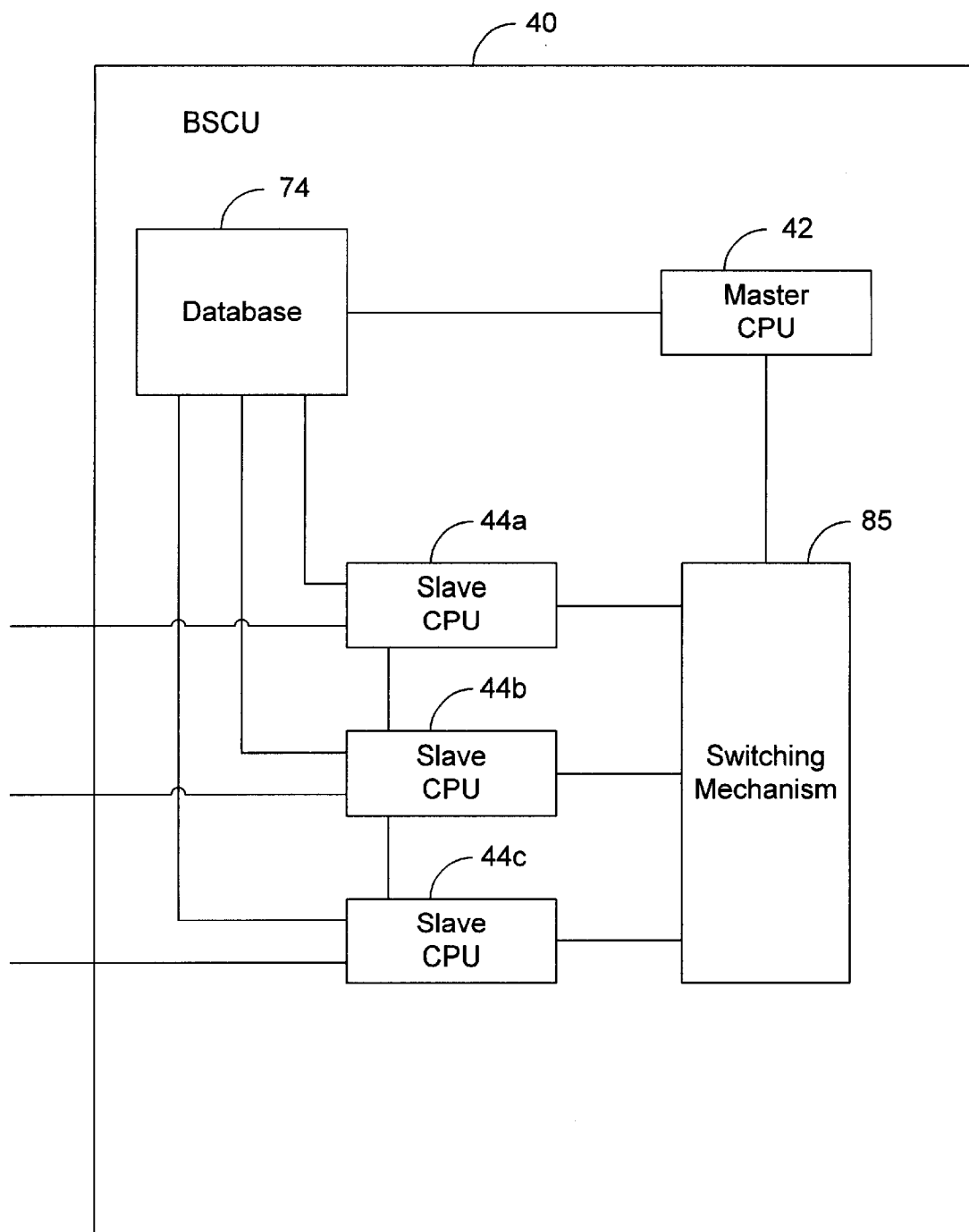

FIG. 4

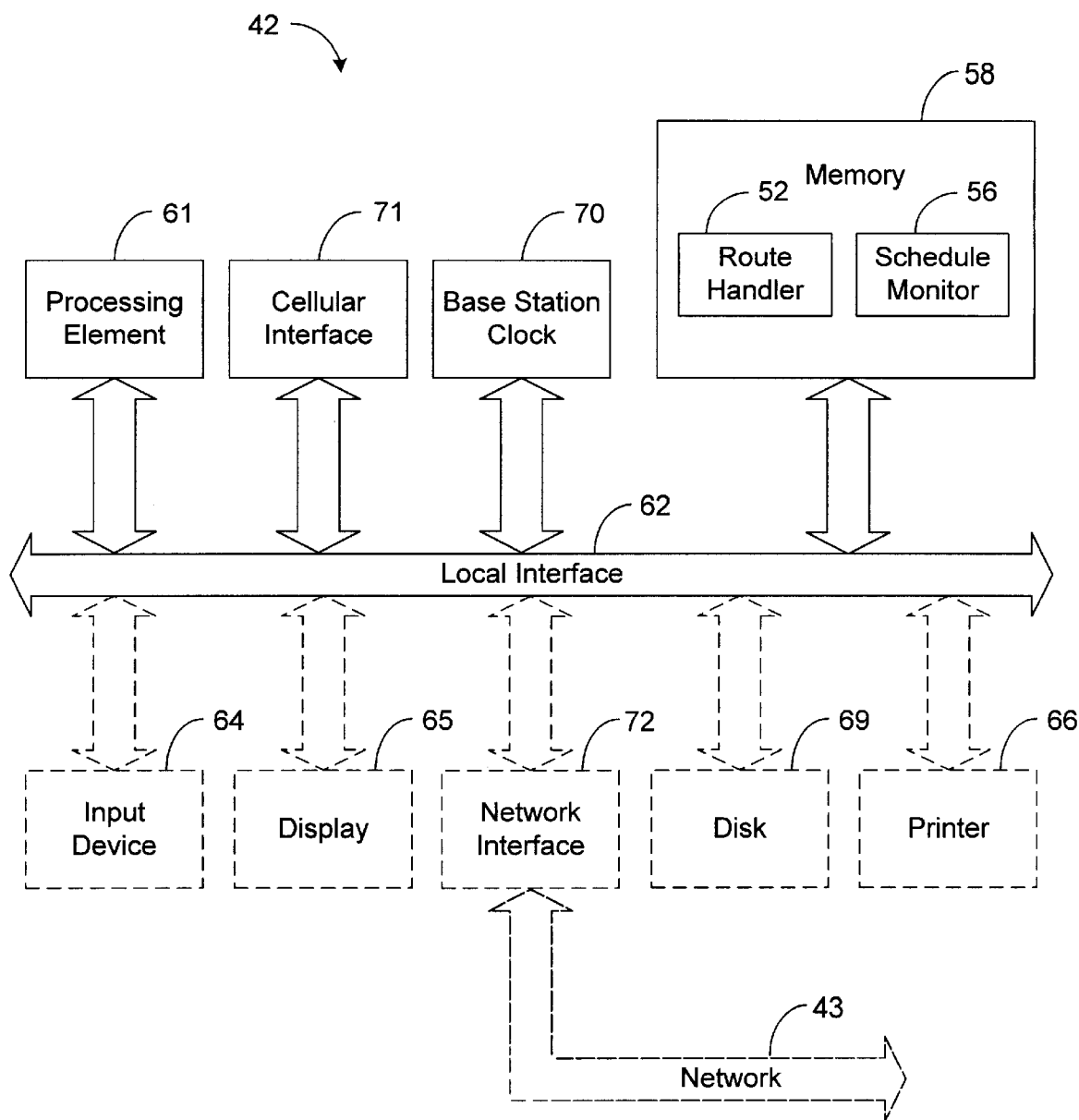

Fig. 5

81
↘

	TIME	Contact Information	Vehicle ID
Entry 1	6:30	1235670987	1112
Entry 2	9:15	1235290945	2034
Entry 3	12:45	1235467867	1390
Entry 4	15:30	1234342313	0999

FIG. 6

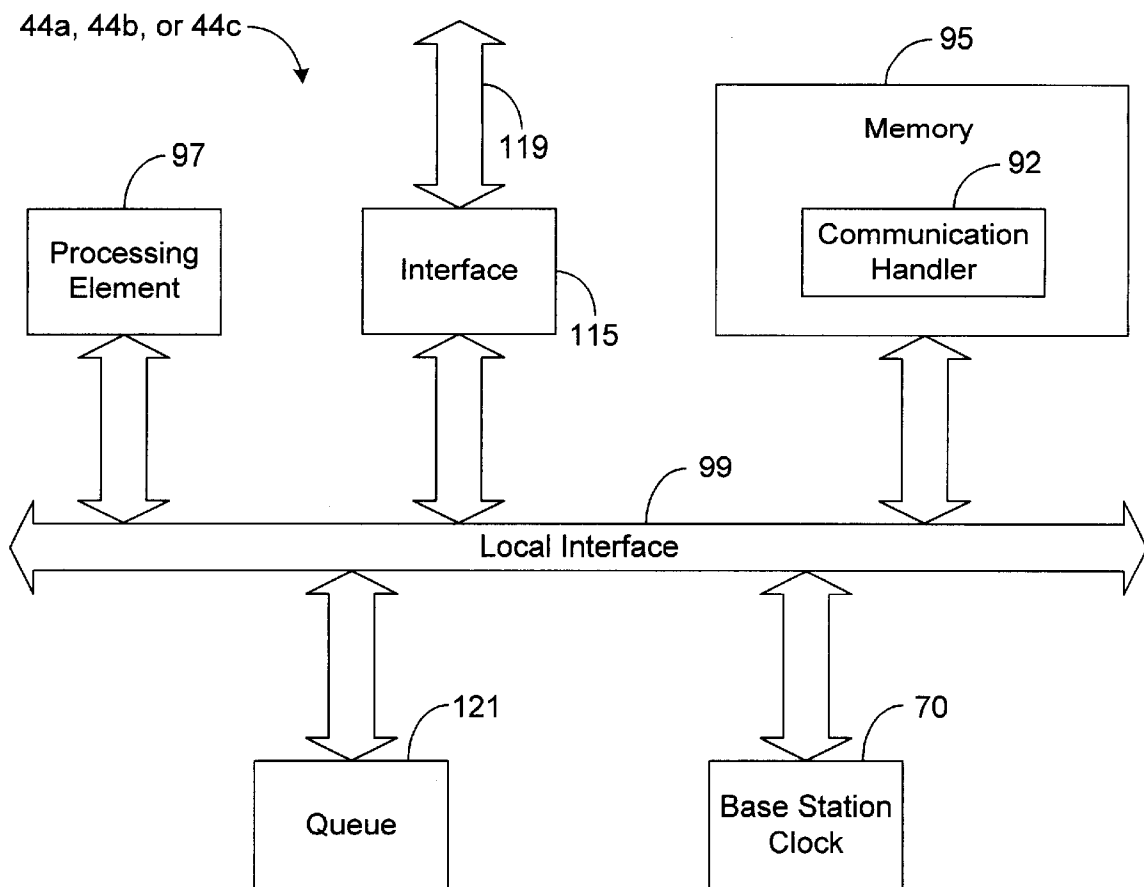

FIG. 7

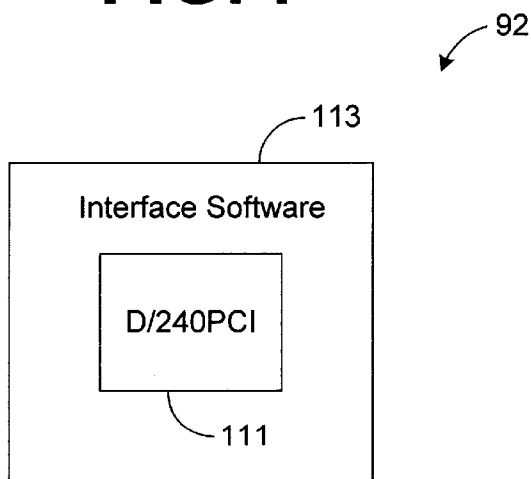

FIG. 8

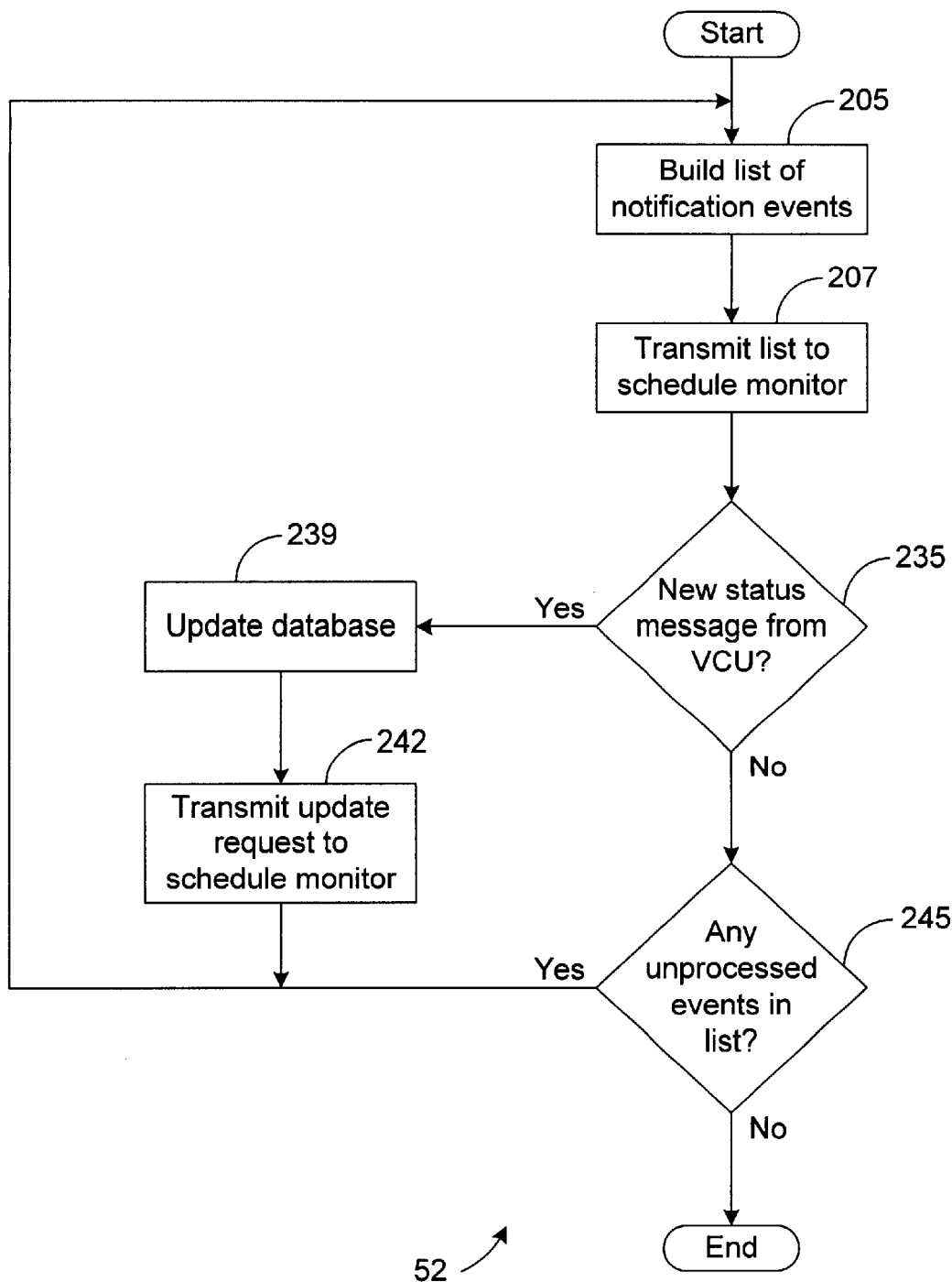

FIG. 9

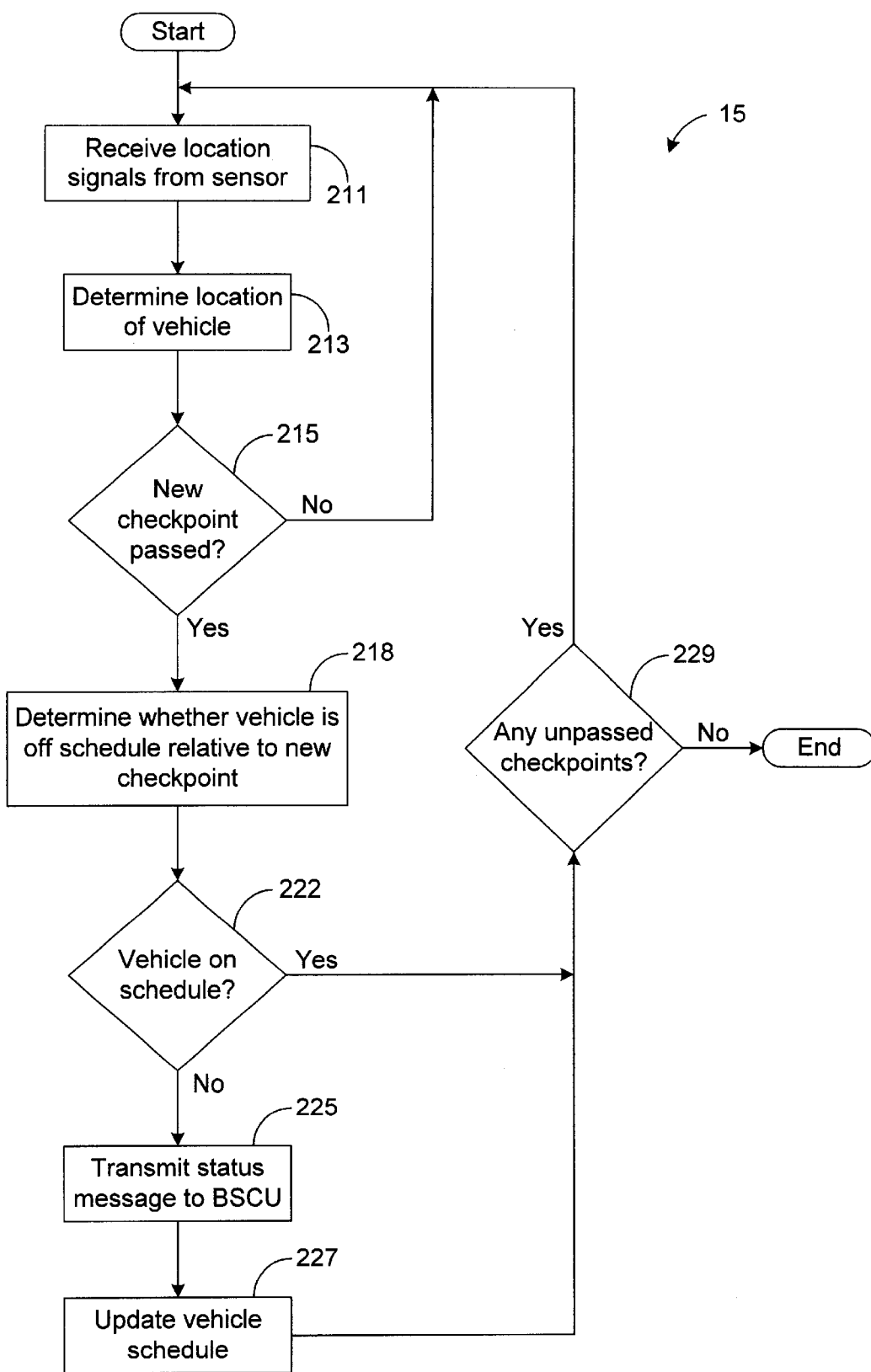

FIG. 10

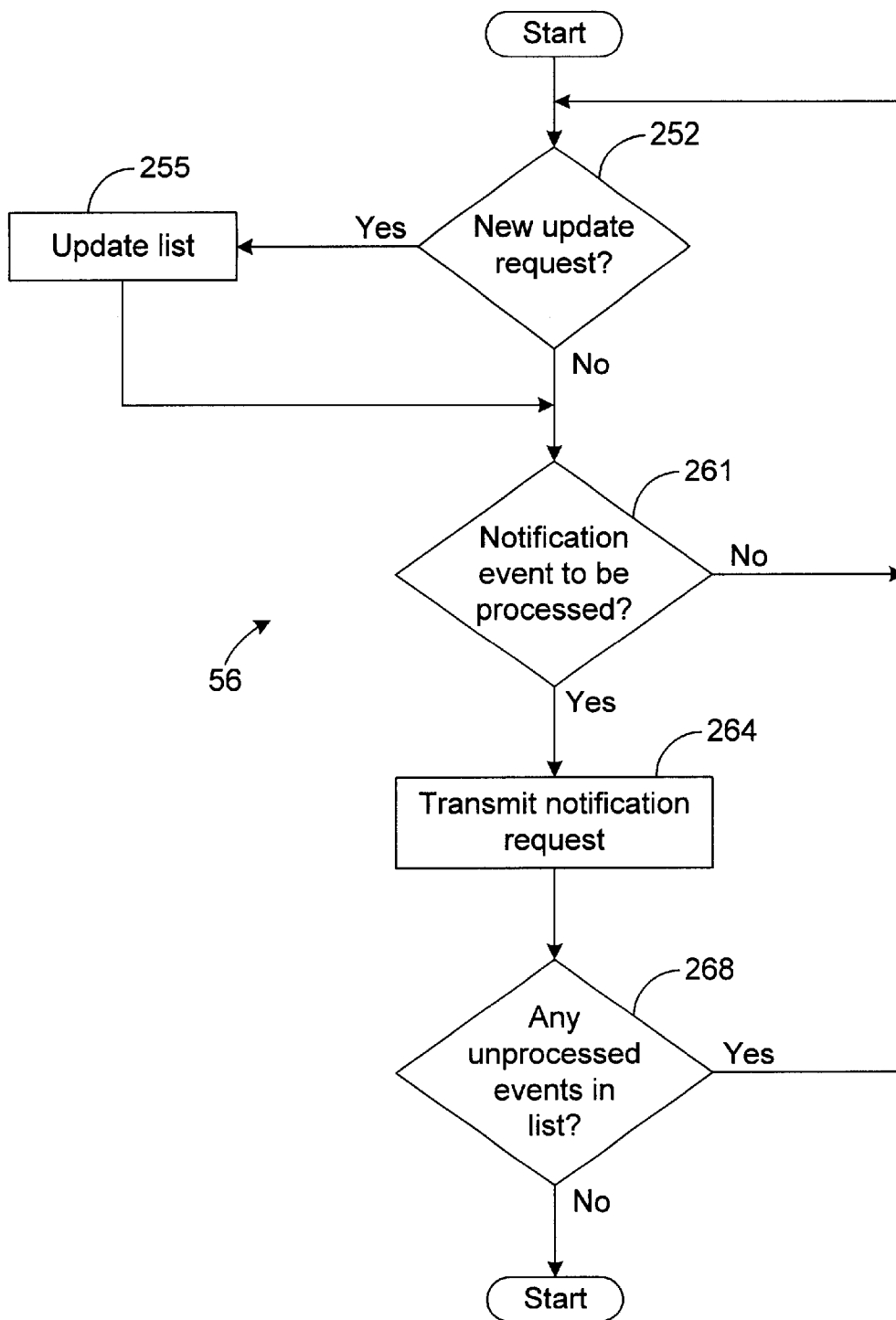

FIG. 11

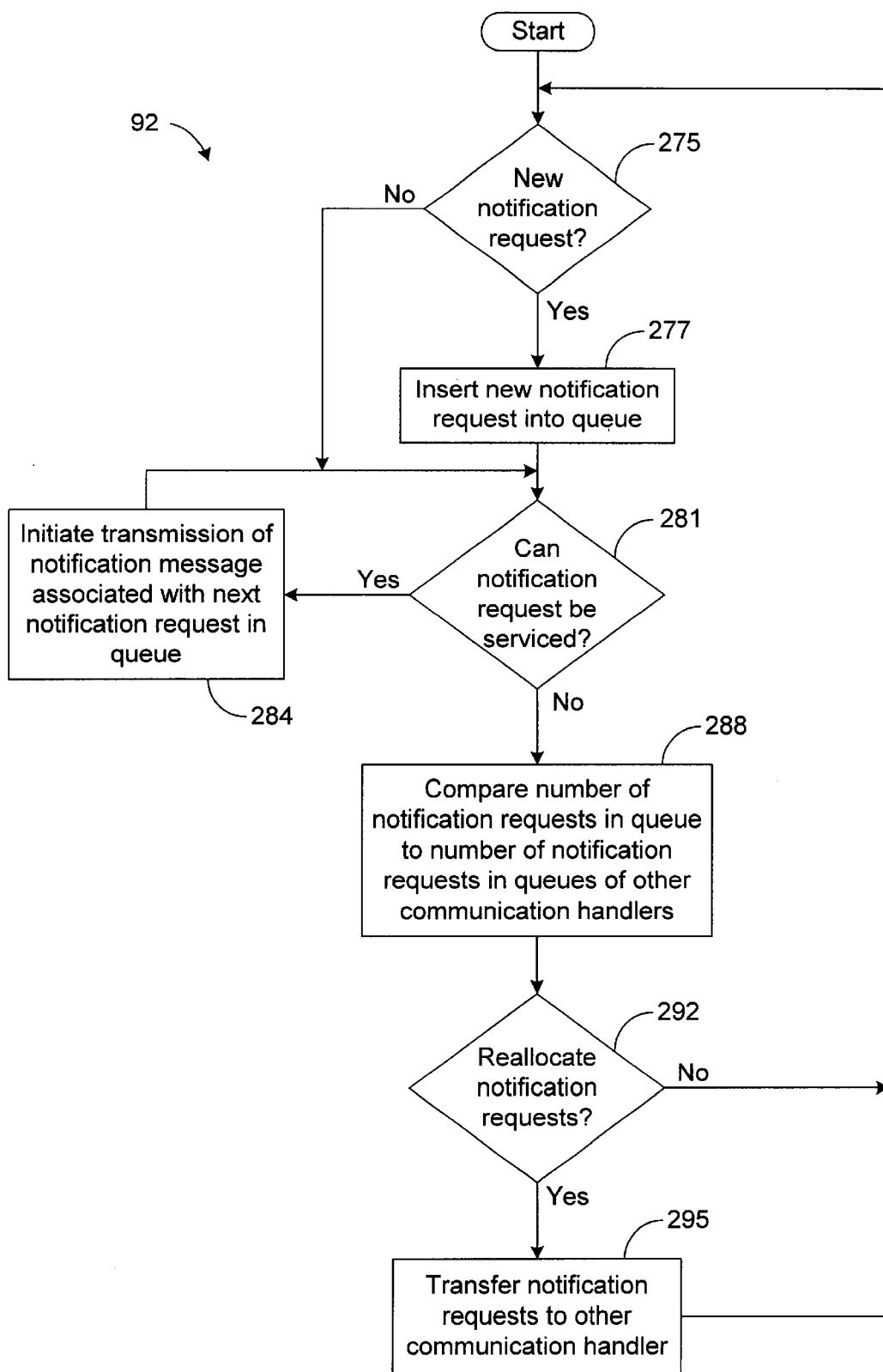

FIG. 12

US 6,317,060 B1

1

**BASE STATION SYSTEM AND METHOD
FOR MONITORING TRAVEL OF MOBILE
VEHICLES AND COMMUNICATING
NOTIFICATION MESSAGES**

**CLAIM OF PRIORITY AND CROSS
REFERENCE TO RELATED APPLICATIONS**

This document claims priority to U.S. provisional patent application entitled "BASE STATION APPARATUS AND METHOD FOR MONITORING TRAVEL OF MOBILE VEHICLE," assigned Ser. No. 60/122,482 and filed on Mar. 1, 1999, which is incorporated herein by reference.

BACKGROUND OF THE INVENTION

1. Field of the Invention

The present invention generally relates to vehicle monitoring and messaging systems and, in particular, to a vehicle monitoring system and method capable of communicating a plurality of notification messages to warn users of impending arrivals of vehicles.

2. Related Art

U.S. Pat. No. 5,400,020, entitled "Advance Notification System and Method," which is incorporated herein by reference, describes a system and method for communicating notification messages to users to warn the users of impending arrivals of vehicles. In this regard, each vehicle associated with the system is equipped with a tracking sensor, which is used to determine the location of the vehicle. Location signals indicating the location of the vehicle as the vehicle travels are transmitted to a base station control unit, which monitors the travel of the vehicle. When the vehicle is within a predefined time or distance of a particular location, the base station control unit transmits a notification message to a user. Therefore, the user is warned of the impending arrival of the vehicle at the particular location.

However, the base station control unit may be used to monitor the travel of a large number of vehicles or may be used to warn a large number of users of impending arrivals of a vehicle or vehicles. Furthermore, servicing a large number of vehicles and/or users may result in the need to simultaneously transmit a large number of notification messages. Accordingly, the ability to efficiently process data for a large number of vehicles and/or users and to efficiently transmit a large number of notification messages is critical in many applications.

Thus, a heretofore unaddressed need exists in the industry for better systems, apparatuses, and methods for accurately and efficiently tracking and/or reporting the status of mobile vehicles as the vehicles travel.

SUMMARY OF THE INVENTION

The present invention overcomes many inadequacies and deficiencies of the prior art, as discussed hereinbefore. In general, the present invention provides an automated computer-based apparatus and method for monitoring travel of vehicles and for efficiently communicating notification messages to warn users of impending arrivals of the vehicles.

In a broad sense, the automated computer-based apparatus of the present invention includes a route handler, a schedule monitor, and a communication handler. The schedule monitor determines when users should receive notification messages based on data that indicates when vehicles are expected to arrive at certain locations. The route handler

2

communicates with vehicle control units on board the vehicles to determine how much any of the vehicles are off schedule. If any of the vehicles are off schedule, the route handler updates the data monitored by the schedule monitor to change when the schedule monitor determines that the notification messages should be received by the users.

Once the schedule monitor determines that a user should receive a notification message, the schedule monitor transmits a notification request to the communication handler. The communication handler then establishes communication with a communication device associated with the user and transmits a notification message to the user. Therefore, the user is warned of an impending arrival of a vehicle at a particular location.

In accordance with another feature of the present invention, the route handler selects portions of the data that are associated with notification events expected to occur during a particular time period. During the particular time period, the schedule monitor monitors the selected data to determine whether any notification messages should be received by users during the particular time period.

In accordance with another feature of the present invention, the communication handler stores the notification request and determines a number of notification requests stored by the communication handler. The communication handler then compares this number to a number of notification requests stored by another communication handler and transmits the notification request to the other communication handler if the difference in the two numbers exceeds a predefined threshold.

Other features and advantages of the present invention will become apparent to one skilled in the art upon examination of the following detailed description, when read in conjunction with the accompanying drawings. It is intended that all such features and advantages be included herein within the teachings of the present invention, as set forth herein and as sought to be protected by the claims.

BRIEF DESCRIPTION OF THE DRAWINGS

The invention can be better understood with reference to the following drawings. The elements of the drawings are not necessarily to scale relative to each other, emphasis instead being placed upon clearly illustrating the principles of the invention. Furthermore, like reference numerals designate corresponding parts throughout the several views.

FIG. 1 is a block diagram illustrating a vehicle tracking system employed within the context of an advance notification system in accordance with the present invention.

FIG. 2 is a block diagram illustrating an implementation of the vehicle control unit of FIG. 1 in accordance with the present invention.

FIG. 3 is a block diagram illustrating a computer implementing the functionality of the vehicle control unit of FIG. 2 in accordance with the present invention.

FIG. 4 is a block diagram illustrating an implementation of the base station control unit of FIG. 1 in accordance with the present invention.

FIG. 5 is a block diagram illustrating a computer implementing the functionality of the master computer depicted in FIG. 4 in accordance with the present invention.

FIG. 6 is a schematic illustrating an exemplary list of notification events generated by the route handler of FIG. 5.

FIG. 7 is a block diagram illustrating a computer implementing the functionality of the slave computers depicted in FIG. 4 in accordance with the present invention.

US 6,317,060 B1

3

FIG. 8 is a block diagram illustrating a more detailed view of the communication handler depicted in FIG. 7.

FIG. 9 is a flow chart illustrating the architecture, functionality, and operation of the route handler of FIG. 5.

FIG. 10 is a flow chart illustrating the architecture, functionality, and operation of the vehicle control unit of FIG. 2 while the vehicle control unit is tracking the vehicle of FIG. 1.

FIG. 11 is a flow chart illustrating the architecture, functionality, and operation of the communication handler of FIG. 5.

FIG. 12 is a flow chart illustrating the architecture, functionality, and operation of the communication handler of FIG. 7.

DETAILED DESCRIPTION OF THE INVENTION

FIG. 1 depicts an automated vehicle tracking system 10 illustrating the principles of the present invention. As shown by FIG. 1, the vehicle tracking system 10 is preferably employed within the context of an automated advance notification system 12 that automatically provides advance notice of impending arrivals of vehicles at destinations or other locations.

As depicted in FIG. 1, a vehicle control unit (VCU) 15 is disposed on a mobile vehicle 17, which is capable of transporting the VCU 15 over various distances. U.S. patent application entitled "System and Method for an Advance Notification System for Monitoring and Reporting Proximity of a Vehicle," assigned Ser. No. 09/163,958, and filed on Sep. 30, 1998, which is incorporated herein by reference, describes an exemplary VCU 15 that may be used to implement the principles of the present invention.

Preferably, the vehicle 17 is a delivery vehicle for delivering items to a destination or for picking up items at a destination. Note that items can include many various types of packages or goods to be delivered or picked up. Furthermore, items can also include persons to be picked up or delivered, such as when a bus picks up and/or delivers passengers at different bus stops. Preferably, the vehicle 17 travels along a predetermined route in making its deliveries, and the vehicle 17 may make numerous stops along its route in order to deliver or pick up different items at different locations.

Vehicle Control Unit

A more detailed view of the VCU 15 is depicted in FIG. 2. A sensor 18 within VCU 15 is configured to determine the location of the sensor 18 relative to a predetermined reference point. Preferably, sensor 18 is a global positioning system (GPS) sensor, although other types of positioning systems and/or sensors are also possible. For example, other types of sensors 18 that may be used to implement the principles of the present invention include, but are not limited to, an odometer or sensors associated with Glonass, Loran, Shoran, Decca, or Tacan. The GPS sensor 18 is configured to receive signals 21a-21c from a plurality of GPS satellites 23, and as known in the art, sensor 18 is designed to analyze signals 21a-21c to determine the sensor's location or coordinate values relative to a predetermined reference point.

For example, in the foregoing embodiment where sensor 18 is a GPS sensor, the sensor 18 determines the sensor's location values relative to the Earth's zero degree latitude and zero degree longitude reference point, which is located at the intersection of the Equator and the Prime Meridian. U.S. Pat. No. 5,781,156 entitled "GPS Receiver and Method

4

for Processing GPS Signals" and filed on Apr. 23, 1997 by Krasner, which is incorporated herein by reference, discusses the processing of GPS signals 21a-21c received from GPS satellites 23 in order to determine the sensor's location values. Since the sensor 18 is located on or within the vehicle 17, the location values determined by the sensor 18 are assumed to match the location values of the vehicle 17 and the VCU 15.

It should be noted that the term "location value" shall be defined herein to mean any value or set of values that may be used to determine a location of a point on the Earth or within the Earth's atmosphere. This value may be a distance value, a coordinate value (i.e., grid value), polar value, vector value, or any other type of value or values known in the art for indicating locations of points.

Sensor 18 is designed to periodically transmit a signal 27 to vehicle manager 29 indicating the vehicle's current location values. Vehicle manager 29 is configured to receive signal 27 and to monitor the location of the vehicle 17 over time by processing multiple signals 27. The vehicle manager 29 can be implemented in software, hardware, or a combination thereof. Preferably, as illustrated by way of example in FIG. 3, the vehicle manager 29 of the present invention along with its associated methodology is implemented in software and stored in computer memory 30 of a computer system 31.

Note that the vehicle manager 29 can be stored and transported on any computer-readable medium for use by or in connection with an instruction execution system, apparatus, or device, such as a computer-based system, processor-containing system, or other system that can fetch the instructions from the instruction execution system, apparatus, or device and execute the instructions. In the context of this document, a "computer-readable medium" can be any means that can contain, store, communicate, propagate, or transport the program for use by or in connection with the instruction execution system, apparatus, or device. The computer readable medium can be, for example but not limited to, an electronic, magnetic, optical, electromagnetic, infrared, or semiconductor system, apparatus, device, or propagation medium. More specific examples (a nonexhaustive list) of the computer-readable medium would include the following: an electrical connection (electronic) having one or more wires, a portable computer diskette (magnetic), a random access memory (RAM) (magnetic), a read-only memory (ROM) (magnetic), an erasable programmable read-only memory (EPROM or Flash memory) (magnetic), an optical fiber (optical), and a portable compact disc read-only memory (CDROM) (optical). Note that the computer-readable medium could even be paper or another suitable medium upon which the program is printed, as the program can be electronically captured, via for instance optical scanning of the paper or other medium, then compiled, interpreted or otherwise processed in a suitable manner if necessary, and then stored in a computer memory. As an example, the vehicle manager 29 may be magnetically stored and transported on a conventional portable computer diskette.

The preferred embodiment of the computer system 31 of FIG. 3 comprises one or more conventional processing elements 32, such as a digital signal processor (DSP), that communicate to and drive the other elements within the system 31 via a local interface 33, which can include one or more buses. Furthermore, an input device 34, for example, a keyboard or a mouse, can be used to input data from a user of the system 31, and screen display 35 or a printer 36 can be used to output data to the user. A disk storage mechanism

US 6,317,060 B1

5

37 can be connected to the local interface 33 to transfer data to and from a nonvolatile disk (e.g., magnetic, optical, etc.). Furthermore, a vehicle clock 38 may be connected to the computer system 31 so that components of the system 31 may utilize data from the clock 38 to determine time through conventional techniques. It should be noted that input device 34, display 35, printer 36, and disk 37 are optional and are not necessarily a part of the preferred embodiment.

The vehicle manager 29 is preferably configured to maintain a predefined schedule 39, referred to herein as the "vehicle schedule 39," within memory 30. The predefined vehicle schedule 39 corresponds with a route of travel for the vehicle 17. In this regard, the predefined vehicle schedule 39 stored in memory 30 includes data defining locations or "checkpoints" along the vehicle's intended route of travel. Furthermore, each checkpoint is associated with a particular time value indicating when the vehicle 17 is expected to pass the associated checkpoint. Each checkpoint along with its associated time value may define an entry in the vehicle schedule 39.

Preferably, the time value associated with a checkpoint corresponds to a time of day that the vehicle 17 is expected to pass the checkpoint. For example, the time value associated with a checkpoint may define the hour and minute that the vehicle 17 is expected to pass the checkpoint. Consequently, when the vehicle 17 reaches the location defined by the checkpoint, the time of day, as defined by vehicle clock 38, can be compared with the time value in the schedule 39 associated with the checkpoint to determine whether the vehicle 17 is early, late, or on time. It should be noted that other data and other methodologies, such as the those disclosed in U.S. Pat. No. 5,400,020, for example, may be employed to determine whether or not the vehicle 17 is on schedule, without departing from the principles of the present invention.

As the vehicle 17 travels along its route, the vehicle manager 29 determines when the vehicle 17 passes a checkpoint by comparing the data received from sensor 18 with the checkpoint data stored in vehicle schedule 39. When the vehicle manager 29 determines that a checkpoint has been passed, the vehicle manager 29 is configured to determine a time value indicating the time of day by analyzing vehicle clock 38, and the vehicle manager 29 is configured to compare this time value with the time value in the schedule 39 associated with the checkpoint.

The vehicle 17 is considered to be off schedule if the value for the time of day from clock 38 differs from the time value in schedule 39 by a predetermined amount. Otherwise the vehicle 17 is considered to be on schedule. For example, assume that the vehicle 17 is to be considered off schedule if the vehicle 17 is early or late by more than two minutes and assume that the vehicle 17 is scheduled to pass a checkpoint at 6:30 a.m. If the vehicle 17 passes the checkpoint between 6:28 a.m. and 6:32 a.m., the vehicle 17 is on schedule. If the vehicle 17 passes the checkpoint before 6:28 a.m., the vehicle is off schedule and is early. If the vehicle 17 passes the checkpoint after 6:32 a.m., the vehicle 17 is off schedule and is late.

If the vehicle manager 29 determines that the vehicle 17 is off schedule, the vehicle manager 29 is configured to transmit a status message to a base station control unit (BSCU) 40 (FIG. 1) indicating how much the vehicle is off schedule, and the vehicle manager 29 is also configured to update the entries in the schedule 39. For example, assume that the vehicle 17 passes the aforementioned checkpoint at 6:25 a.m. In this example, the vehicle 17 is off schedule and five minutes early. Therefore, the vehicle manager 29 trans-

6

mits a status message to BSCU 40 via cellular network 42 indicating that the vehicle 17 is five minutes early and decreases the expected times stored in the schedule 39 by five minutes. As a result, the schedule 39 is adjusted to account for the vehicle's earliness, and the vehicle 17 will not be deemed off schedule when the vehicle 17 passes the other checkpoints, provided that the rate of travel of the vehicle 17 continues as expected for the remainder of the route. Similarly, if the vehicle 17 passes the aforementioned checkpoint at 6:35 a.m., then the vehicle manager 29 is configured to transmit a status message indicating that the vehicle 17 is five minutes late and is configured to increase the times stored in the schedule 39 by five minutes.

It should be noted that updating the schedule 39 is not necessary in implementing the present invention. However, if the vehicle 17 is early or late at one checkpoint, the vehicle 17 will likely be respectively early or late at other checkpoints causing the vehicle manager 29 to make an off schedule determination and to transmit a status message at each of the remaining checkpoints in the route. By updating the times in schedule 39, the number of status messages transmitted to the BSCU 40 may be reduced in monitoring the travel of the vehicle 17.

It should be further noted that the status message transmitted by VCU 15 may be communicated via any suitable technique and that utilization of the cellular network 42 is not necessary. In this regard, other types of networks may be used to communicate the status message, or the status message may be communicated directly to the base station control unit 40 without the use of any type of communication network. For example, the status message may be communicated via short wave radio.

Base Station Control Unit

Referring to FIG. 4, the base station control unit (BSCU) 40 preferably comprises a master computer system 42 that controls one or more slave computer systems 44a, 44b, and 44c. Referring to FIG. 5, the master computer system 42 includes a route handler 52 and a schedule monitor 56. The route handler 52 and schedule monitor 56, which will be described in further detail hereafter, can be implemented in software, hardware, or a combination thereof. Preferably, as illustrated by way of example in FIG. 5, the route handler 52 and schedule monitor 56 of the present invention along with their associated methodology are implemented in software and stored in memory 58.

Further shown by FIG. 5, the computer system 42 may include one or more processing elements 61, such as a DSP, that communicate to and drive the other elements within the system 42 via a local interface 62, which may include one or more buses. Furthermore, an input device 64, for example, a keyboard or a mouse, can be used to input data from a user of the system 42, and screen display 65 or a printer 66 can be used to output data to the user. A disk storage mechanism 69 can be connected to the local interface 62 to transfer data to and from a nonvolatile disk (e.g., magnetic, optical, etc.). Furthermore, a base station clock 70 may be connected to the computer system 42 so that components of the system 42 may utilize data from the clock 70 to determine time through conventional techniques. The system 42 may also be connected to a cellular interface 71, or other type of suitable interface, for communicating with VCU 15. It may also be desirable for computer system 42 to include a network interface 72 that allows the system 42 to exchange data with a network 73. It should be noted that input device 64, display 65, printer 66, disk 69, network interface 72, and network 73 are optional and are not necessarily a part of the preferred embodiment.

US 6,317,060 B1

7

Referring again to FIG. 4, the database 74 shown by FIG. 4 preferably stores data defining the routes of one or more vehicles 17. For example, the database 74 may include entries that are correlated with a vehicle 17 of the system 10, wherein each entry includes sufficient data to define a checkpoint that may be used to monitor the travel of the vehicle 17. The checkpoints defined in the database 74 for a particular vehicle 17 are preferably the same checkpoints defined in vehicle schedule 39 for the particular vehicle 17. Furthermore, the entry may also include data to indicate the time of day that the vehicle 17 is expected to reach the checkpoint defined by the entry. Therefore, the database 74 includes sufficient data to define the checkpoints used to monitor the vehicles 17 associated with the system 10 and the times that the vehicles 17 should respectively pass the checkpoints.

Preferably, the database 74 also includes data indicating when different users are to be notified of an impending arrival of at least one of the vehicles 17 associated with the system 10. For example, the database 74 may include data indicating that a user should be notified a certain amount of time before or after a particular vehicle 17 passes a particular checkpoint. Therefore, at any time, the database 74 can be queried to determine which checkpoints are to be passed by a particular vehicle 17 and when the particular vehicle 17 is expected to pass each of the checkpoints. The database 74 also can be queried to determine when users are to be notified of the particular vehicle's impending arrival. To facilitate querying of the database, the entries of the database 74 may be keyed by vehicle numbers used to identify the vehicles associated with the system 10.

To illustrate the configuration and use of the database 74, assume that a user would like to be notified when a particular vehicle 17 is two minutes from a particular location, such as the user's house or a scheduled vehicle stop. Assume further that the vehicle 17 is scheduled to pass a checkpoint every five minutes after starting its route and that the particular location is expected to be reached seventeen minutes after the vehicle 17 starts its route. In this scenario, the database 74 should include data that defines each of the checkpoints along the vehicle's route and that indicates the time that the vehicle 17 is expected to pass each of the checkpoints. The database 74 should also indicate that the individual is to be notified when the vehicle 17 passes the third checkpoint, since the vehicle 17 is expected to pass the third checkpoint fifteen minutes into the route (i.e., two minutes before the vehicle 17 is expected to reach the particular location).

The database 74 also preferably includes sufficient information to enable the individual to be automatically notified once a determination is made that the user should be notified. For example, the database 74 may include the individual's telephone number, pager number, e-mail address, or other type of contact information, depending on the methodology used to notify the individual.

The route handler 52 (FIG. 5) is configured to query the database 74 to build a list of notification events that are expected to occur during a specified time period. A "notification event" is the generation of a notification message to be transmitted to a user to notify the user of an impending arrival of a vehicle 17 associated with the system 10. For example, the route handler 52 may query the database 74 at the beginning of a day to determine each notification event that should occur during the course of the day, and the route handler 52 then builds a list of these events. The list should not only indicate what notification events are to occur but also should indicate at what time each notification event is expected to occur. The list may also include contact infor-

8

mation (e.g., telephone numbers, pager numbers, e-mail addresses etc.) to facilitate the process of contacting the users associated with the notification events in the list.

FIG. 6 shows an exemplary list 81 that may be produced by the route handler 52. The list 81 depicts four entries, although any number of entries may be included in the list 81. Each entry of the list 81 is associated with a respective notification event and indicates: (1) the time at which the respective notification event is expected to occur, (2) the contact information (e.g., telephone number, pager number, e-mail address etc.) associated with the particular user, and (3) a vehicle number identifying the particular vehicle 17 associated with the notification event. For example, assume that "entry 1" is associated with a notification event for a user that would like to be notified when a particular vehicle (vehicle number "1112") is five minutes from a particular location. Based on the information stored in database 74, assume that the route handler 52 determines that the notification event should occur at 6:30 a.m. (five minutes before the particular vehicle 17 is scheduled to arrive at the particular location). As a result, "entry 1" of the list 81 indicates that the notification event associated with the entry is to occur at 6:30 a.m. "Entry 1" also provides the user's contact information and the vehicle number ("1112") of the vehicle 17 that is to arrive at the particular location. Each of the other entries can be similarly configured based on the information associated with the notification events associated with the other entries. Once the route handler 52 has defined the list 81, the route handler 52 transmits the list 81 to schedule monitor 56.

When the BSCU 40 receives a status message from one of the VCUs 15 indicating that one of the vehicles 17 is early or late, the route handler 52 transmits an update request based on the received status message. In response to the update request, the schedule monitor 56 is designed to update the list 81, if the list 81 includes an entry associated with a notification event pertaining to the one vehicle 17.

For example, assume that the route handler 52 receives a status message indicating that the vehicle 17 associated with "entry 1" (i.e., vehicle number "1112") is seven minutes late. In response, the route handler 52 transmits an update request to schedule monitor 56. The update request preferably includes information indicating which vehicle 17 is off schedule and how much the vehicle 17 is off schedule. Based on this update request, the schedule monitor 56 determines that the vehicle 17 associated with the update request (i.e., vehicle number "1112") is seven minutes late. The schedule monitor 56 is designed to traverse the list 81 to identify each entry associated with the vehicle number "1112" and is configured to increase the time values stored in the identified entries by seven minutes to account for the tardiness of vehicle number "1112." Therefore, in the list 81 depicted by FIG. 6, the schedule monitor 56 changes the time value in "entry 1" from "6:30" to "6:37." As a result, the notification event associated with "entry 1" should not occur until 6:37 a.m.

Upon receiving a status message, the route handler 52 is also designed to update the database 74. Therefore, in the example described hereinbefore, the route handler 52 is designed to input data into the database 74 indicating that vehicle number "1112" is seven minutes late. As a result, the database 74 can be consulted at any time to determine not only the scheduled route of any vehicle 17 but also to determine the status of the vehicle 17 as the vehicle 17 is traveling its route. In this regard, if the database 74 does not indicate that a particular vehicle 17 is early or late, then it can be assumed that the vehicle 17 should arrive at its future

US 6,317,060 B1

9

checkpoints on schedule. However, if the database 74 indicates that the vehicle 17 is early or late, then it can be assumed that the vehicle 17 will arrive at its future checkpoints off schedule by the amount indicated by the database 74.

The schedule monitor 56 is configured to periodically scan the list 81 to determine if a notification event should occur (i.e., if a notification message should be transmitted to a user). In this regard, when the time of the day, as determined from base station clock 70, corresponds to (e.g., matches) the time indicated by one of the entries in the list 81, the schedule monitor 56 determines that the notification event associated with the corresponding entry should occur. Therefore, to initiate the occurrence of the notification event, the schedule monitor 56 is designed to transmit a notification request to one of the slave computers 44a-44c, which transmits a notification message in response to the notification request, as will be described in more detail hereinbelow.

As shown by FIG. 4, a switching mechanism 85, such as an etherswitch, for example, is used to route the notification request to the appropriate slave computer 44a-44c. In an attempt to balance the workload of the slave computers 44a-44c, the schedule monitor 56 preferably selects one of the slave mechanisms 44a-44c to process the notification request based on the number of notification requests previously transmitted to each slave computer 44a-44c within a specified time period. For example, the schedule monitor 56 could be configured to transmit the notification message to the slave computer 44a-44c that has received the least number of notification requests in the last five minutes. As a result, the workload of the slave computers 44a-44c is not likely to become disproportionately high for any one of the slave computers 44a-44c.

As shown by FIG. 7, each of the slave computers 44a-44c includes a communication handler 92 configured to process each notification request received by the computer 44a-44c. The communication handler 92 may be implemented in software, hardware, or a combination thereof. Preferably, as depicted by FIG. 7, the communication handler 92 is implemented in software and stored in memory 95.

Further shown by FIG. 7, each slave computer system 44a-44c may include one or more processing elements 97, such as a DSP, that communicate to and drive the other elements within the system 44a-44c via a local interface 99, which may include one or more buses. Furthermore, the base station clock 70 may be connected to each computer system 44a-44c so that components of the system 44a-44c may utilize data from the clock 70 to determine time through conventional techniques. Each slave computer 44a-44c preferably includes an interface 115, such as a telephone interface, for example, coupled to a plurality of communication connections 119 that enables the communication handler 92 to transmit the notification messages across the connections 119. As an example, the interface 115 may be coupled to a T1 trunk or a plurality of T1 trunks that, as known in the art, are capable of placing up to twenty-four telephone calls each.

The communication handler 92 is preferably capable of processing multiple notification requests and of simultaneously communicating multiple notification messages to users to warn the users of impending arrivals of vehicles 17. For example, in one embodiment, the communication handler 92 is implemented by a D/240PCI card 111 manufactured by Dialogic Corp., as shown by FIG. 8. Other software 113 may be implemented to interface the notification messages with the Dialogic card. This other software 113 may include Visual Voice software, which is a well known set of software commonly used to interface data with the Dialogic card 111.

10

As shown by FIG. 1, the notification messages may be routed to one or more users via a communication network, such as the publicly switched telephone network (PSTN) 123. In this regard, the network 123 routes each notification message transmitted by a communication handler 92 to a communication device 124, such as a telephone, for example, at a premises 126 of a user that is to receive the notification message. Upon receiving the notification message from network 123, the communication device 124 communicates the notification message to the user. It should be noted that the notification messages do not necessarily have to be communicated via telephone calls and that the communications device 124 may be any device capable of communicating a notification message. For example, the communications device 124 may be pager in one embodiment. In another embodiment, the communication handler 92 transmits a notification message to the device 124 via the Internet. For example, the communication handler 92 may transmit an e-mail message to the device 124, which in this example is a computer capable of reading the message and displaying the message to the user.

If a notification request cannot be immediately serviced by the communication handler 92, then the communication handler 92 is designed to store the notification request into a queue 121. The communication handler 92 then services the notification requests stored in the queue 121 on a first in, first out (FIFO) basis. Therefore, the communication handler 92 of each system 44a-44c services the notification requests in the order in which they were received by the communication handler 92.

As stated hereinbefore, each notification request is generated in response to a determination that a user should be warned of an impending arrival of a particular vehicle 17 at a particular location. Therefore, each notification request preferably includes contact information to enable the communication handler 92 to send a notification message to the particular user associated with the notification request or includes other information to enable the communication handler 92 to retrieve such contact information from the database 74. As a result, the communication handler 92 is configured to utilize contact information included in the notification request or stored in the database 74 to transmit a notification request to the user associated with the notification request.

It should be noted that it is possible for the notification message to be user specific. For example, the message may include the phrase "Vehicle number 1112 is five minutes from your vehicle stop." To enable such a message, the vehicle number and the time from the user's stop may be included in the notification request. Therefore, each entry in the list 81 may include, in addition to the information shown in FIG. 6, the amount of time that the vehicle 17 is from the user's selected destination when the notification event associated with the entry is expected to occur.

Furthermore, since there may be a delay between generating a notification request and in servicing the notification request, the communication handler 92 may be designed to query the database 74 to update the notification message before transmission. For example, if the notification request is generated when the vehicle 17 is five minutes from a user's selected destination and if the notification message is transmitted two minutes later, the communication handler 92 can be designed to query the database 74 based on the information provided in the notification request and determine that two minutes have elapsed since the notification request was generated. Therefore, the communication handler 92 may modify the message to include the phrase "Vehicle 1112 is three minutes from your vehicle stop."

It should be further noted that the list **81** is not a necessary feature of the present invention. In this regard, the database **74** can be repeatedly searched to determine when to generate notification requests. However, repeatedly searching the database **74** could result in the unnecessary processing of a vast amount of data, depending on the amount of data and entries stored in database **74**. Utilization of the list **81** enables a much smaller amount of data to be searched in identifying whether notification requests should be generated.

Furthermore, it is not necessary for the communication handlers **92** to be implemented by slave computers **44a-44c**. For example, it may be possible to implement the route handler **52**, the schedule monitor **56**, and the communication handlers **92** in a single computer system, such as system **42**. In addition, the present invention has been described as using three communication handlers **92** for the purposes of illustration only, and any number of communication handlers **92** (i.e., one or more) may be utilized by the system **10**.

In addition, it is possible to use the contents of the database **74** to create a web page indicating the status of the vehicles **17** associated with the system **10**. Therefore, users can access the web page via the Internet or some other suitable communication network to determine whether a particular vehicle **17** is on or off schedule and how much a particular vehicle may be off schedule.

Furthermore, as shown by FIG. **4**, the slave computers **44a-44c** can be connected to one another and can be configured to reallocate notification requests. For example, the communication handlers **92** in the slave computers **44a-44c** can be configured to communicate to one another how many notification requests are currently queued by each of the communication handlers **92**. If the difference in the number of notification requests queued by one communication handler **92** and the number of notification requests queued by another communication handler **92** exceeds a predetermined threshold, then the communication handler **92** having the higher number of queued notification requests preferably transmits one or more of the queued notification requests to the other communication handler **92**. Therefore, the occurrence of one communication handler **92** having a disproportionately high number of queued notification requests should be prevented.

It should be noted that there are many alternative embodiments that may be implemented to reallocate the notification requests without departing from the principles of the present invention. For example, in one embodiment, a first communication handler **92** may be designed to communicate a reallocation request to one or more of the other communication handlers **92** when the number of notification requests queued by the first communication handler falls below a predetermined threshold. In response to the reallocation request, at least one of the other communication handlers **92** transmits one or more of its queued notification requests to the first communication handler **92**, which services the notification request. Other variations for reallocating the notification requests are possible.

In other embodiments, it may be possible for the VCU **15** to transmit notification requests directly to the communication device **124** at the user's premises **126**. Such a system is fully described in U.S. Pat. No. 5,444,444 entitled "Apparatus and Method of Notifying a Recipient of an Unsched-

uled Delivery" and filed on Sep. 16, 1994, by Ross, which is incorporated herein by reference.

Alternative Embodiments

It should be noted that there are many alternative embodiments for implementing the vehicle tracking system **10**. For example, in one alternative embodiment, portions of the schedule monitor **56** are implemented in each of the slave computers **44a-44c**. When implemented in software, the schedule monitor **56** in each slave computer **44a-44c** may be stored in the memory **95** of the slave computer **44a-44c**.

In this example, a list **81** of notification events is created by the route handler **52** in the master computer **42**, as described hereinabove. However, portions (e.g., entries) of the list **81** are transmitted to each slave computer **44a-44c**, which monitors the received portion of the list **81**. For example, once the list **81** is created by the route handler **52**, the route handler **52** is designed to assign certain vehicles **17** to certain ones of the slave computers **44a-44c**. The route handler **52** is designed to then transmit each entry defining a notification event associated with a particular vehicle **17** to the slave computer **44a-44c** assigned to the particular vehicle **17**. The assignment of the vehicles **17** to the slave computers **44a-44c** is preferably controlled by the route handler **52** such that each slave computer **44a-44c** receives a similar number of notification events in an effort to prevent any one slave computer **44a-44c** from becoming overburdened.

The schedule monitor **56** in each slave computer **44a-44c** then builds a notification event list **81** including each of the entries received by the slave computer **44a-44c**. As a result, the functionality of monitoring the list **81** is divided across the slave computers **44a-44c**. Moreover, when a status message from a VCU **15** is received by cellular interface **71**, the route handler **52** in the master computer **42** is designed to determine which slave computer **44a-44c** is assigned to the vehicle **17** associated with the status message. Then, the route handler **52** of the slave computer **42** is designed to transmit the status message to the slave computer **44a-44c** assigned to the foregoing vehicle **17**. The schedule monitor **56** in the slave computer **44a-44a** receiving the status message then updates the list **81** maintained in the slave computer **44a-44c**, via techniques described hereinbefore.

The schedule monitor **56** in each slave computer **44a-44c** monitors the list **81** in the same slave computer **44a-44c** to determine when a notification event should occur. When a notification event occurs, the schedule monitor **56** transmits a notification request to the communication handler **92**, which processes the notification as described hereinbefore. Therefore, the operation of the foregoing embodiment is similar to the embodiment previously described, except that at least some of the functionality of the schedule monitor **56** is implemented in each of the slave computers **44a-44c**. Dividing the functionality of the schedule monitor **56** across multiple slave computers **44a-44c** is advantageous in applications utilizing a relatively large number of notification events, since monitoring of a large number of notification events by the master computer **42** may overload the master computer **42**.

Operation

The preferred use and operation of the system **10** and associated methodology are described hereafter.

US 6,317,060 B1

13

Initially, a vehicle schedule **39** is respectively stored in the VCU **15** of each vehicle **17** associated with the system **10**. As set forth hereinbefore, the vehicle schedule **39** includes data defining a plurality of checkpoints along the vehicle's route or routes of travel and the expected time that the vehicle **17** is to pass each of the checkpoints. There are a variety of methodologies that may be employed to determine the information stored in the VCU **15**. In one embodiment, the data is accumulated from the sensor **18** and the vehicle clock **38**, as the vehicle **17** travels the route or routes. Such a methodology is described in more detail in U.S. patent application entitled "Apparatus and Method for Monitoring Travel of a Mobile Vehicle," assigned Ser. No. 09/395,497, and filed on Sep. 14, 1999, which is incorporated herein by reference.

The route data stored in vehicle schedule **39** is also stored in database **74** of BSCU **40**. Furthermore, contact information associated with each user that is to be notified of an impending arrival of one of the vehicles **17** is also stored in database **74** so that the users may be sent a notification message at appropriate times. Each user is allowed to select a vehicle **17** and a time when the user would like to be warned of an impending arrival of the selected vehicle **17**. The process of enabling a user to select a vehicle and a time is further described in U.S. patent application entitled "System and Method for Activation of an Advance Notification System for Monitoring and Reporting Status of Vehicle Travel," assigned Ser. No. 09/163,588, and filed on Sep. 30, 1998, which is incorporated herein by reference.

As shown by blocks **205** and **207** of FIG. **9**, the route handler **52** builds a list **81** of notification events that should occur during a specified time period and transmits this list **81** to schedule monitor **56**. For illustrative purposes, assume that the user selects to receive a notification message when a particular vehicle **17** is five minutes from a particular location. Further assume that the vehicle **17** is scheduled to arrive at the particular location at 6:35 a.m., which is within the aforementioned specified time period. As a result, the user should receive a notification message at 6:30 a.m., if the vehicle **17** is on schedule when traveling the route, and in performing block **205**, the route handler **52** defines an entry in the list **81** indicating that the user should be so notified at 6:30 a.m. "Entry 1" of the list **81** depicted by FIG. **6** is suitable for implementing the present invention in the context of the foregoing example.

At some point, the vehicle **17** begins to travel its route. Before or during travel of the route, the vehicle clock **38** should be synchronized with the BSCU clock **70**. As vehicle **17** travels its route, it passes checkpoints, and its VCU **15** monitors its progress. In this regard, based on the signals provided by sensor **18**, the VCU **15** determines when vehicle **17** passes each of its checkpoints, as shown by blocks **211**, **213**, and **215** of FIG. **10**. As depicted by blocks **218** and **222**, when vehicle **17** passes a checkpoint, the VCU **15** determines whether the vehicle **17** is on or off schedule by comparing the current time, as defined by vehicle clock **38**, with the time value associated with the passed checkpoint and stored in vehicle schedule **39**.

If vehicle **17** is determined to be off schedule, then the VCU **15** transmits a status message to BSCU **40** indicating how much the vehicle **17** is off schedule and updates the

14

time values associated with the remaining checkpoints (i.e., the checkpoints that have yet to be passed by vehicle **17**), as shown by blocks **225** and **227**. As depicted by block **229**, the VCU **15** continues to monitor the progress of vehicle **17** until vehicle **17** passes the last checkpoint on the route.

Upon receiving a status message from the VCU **15**, the route handler **52** updates the database **74** to indicate that the vehicle **17** is off schedule by an amount indicated by the status message, as depicted by blocks **235** and **239** of FIG. **9**. Next, as shown by block **242**, the route handler **52** transmits an update request to the schedule monitor **56** indicating that the vehicle **17** associated with the status message is off schedule by a specified amount (e.g., a specified number of minutes early or late). As shown by block **245**, the route handler **52** continues to check for status messages until each notification event in the list **81** has occurred.

As shown by blocks **252** and **255** of FIG. **11**, the schedule monitor **56** updates the list **81** when the schedule monitor **56** receives an update request from route handler **52**. In this regard, when the schedule monitor **56** receives an update request indicating that a vehicle **17** is off schedule, the schedule monitor **56** changes the time values in the entries associated with the vehicle **17** by an amount that the vehicle **17** is off schedule.

As depicted by block **261**, the schedule monitor **56** periodically checks to determine whether any notification events should occur. In this regard, the schedule monitor **56** compares the current time, as determined by the BSCU clock **70**, with the time values in the list **81**. If the time value of an entry in the list **81** corresponds with the current time (e.g., matches the current time, in the preferred embodiment), then the schedule monitor **56** determines that a notification message should be transmitted to a user to warn the user of an impending arrival of the vehicle **17** associated with the entry. Therefore, in block **264**, the schedule monitor **56** transmits a notification request to one of the communication handlers **92** indicating that a user should be notified. The notification request preferably includes data identifying the user (such as the user's telephone number, pager number, e-mail address, or any other value unique to the user) and identifying the vehicle **17** associated with the notification event. As shown by block **268**, the schedule monitor **56** continues to monitor the entries in the list **81** until each notification event defined by the entries has occurred.

As shown by blocks **275** and **277** of FIG. **12**, each communication handler **92** places any new notification request received from schedule monitor **56** into a respective queue. As depicted by blocks **281** and **284**, each communication handler **92** determines whether a new call can be initiated via interface **115** and initiates transmission of a notification message if the interface **115** can handle a new call. In this regard, the communication handler **92** uses the information in the notification request to identify the user that should be notified by the notification message. The information in the notification request may either include the contact information needed to establish communication with the user or the communication handler **92** may look up the contact information in the database **74**.

Furthermore, the notification message may provide a status report for the vehicle **17** associated with the notifica-

US 6,317,060 B1

15

tion request. For example, the notification message may indicate that the vehicle 17 is a certain number of minutes from a particular location. The communication handler 92 may retrieve information from the database 74 to form the notification message. By retrieving the information for the status report directly from the database 74, the communication handler 92 utilizes the most recent information available in providing any status reports to the user.

If the interface 115 cannot handle a new call (e.g., the interface 115 is not operating properly or there are no available communication lines 119) the communication handler 92 preferably checks to see if another communication handler 92 has a disproportionately less number of notification requests queued, as shown by block 288. If the difference in the number of queued notification requests in the two communication handlers 92 being compared in block 288 exceeds a predetermined threshold, then the communication handler 92 reallocates the queued notification requests by transmitting one or more of its queued notification requests to the other communication handler 92 that has a smaller number of queued notification requests, as depicted by blocks 292 and 295. Ultimately, a notification message is transmitted by one of the communication handlers for each notification request transmitted by the schedule monitor 56.

It should be noted that the present invention has been described herein as determining when to initiate a notification message to a user based on a time value. However, other types of values may be used to monitor the travel of the vehicle 17. For example, a notification message could be initiated when a particular vehicle comes within a certain distance of a particular location. U.S. patent application entitled "Base Station Apparatus and Method for Monitoring Travel of a Mobile Vehicle," assigned Ser. No. 09/395,501, and filed on Sep. 14, 1999, which is incorporated herein by reference, describes how distance values may be used to determine when to transmit notification messages.

It should be emphasized that the above-described embodiments of the present invention, particularly, any "preferred" embodiments, are merely possible examples of implementations, merely set forth for a clear understanding of the principles of the invention. Many variations and modifications may be made to the above-described embodiment(s) of the invention without departing substantially from the spirit and principles of the invention. All such modifications and variations are intended to be included herein within the scope of the present invention and protected by the claims.

Now, therefore, the following is claimed:

1. A system for notifying users of impending arrivals of vehicles at particular locations, comprising:

- memory storing a first time value, said first time value indicating when a user should be notified of an impending arrival of a vehicle;
- a clock configured to produce a second time value;
- a route handler configured to receive a status message from said vehicle and to transmit an update request when said vehicle is off schedule based on said status message;
- a schedule monitor configured to compare said first time value to said second time value and to produce and

16

transmit a notification request based on a comparison of said time values, said schedule monitor further configured to update said first time value in response to said update request; and

5 a communication handler configured to receive said notification request and to transmit a notification message to said user in response to said notification request, said communication handler further configured to store said notification request and to determine a number of notification requests stored by said communication handler, said communication handler further configured to compare said number of notification requests to a threshold number and to cause reallocation of notification requests between said communication handler and at least one other communication handler based on a comparison of said number of notification requests to said threshold number.

2. The system of claim 1, wherein said communication handler receives a notification request in response to said reallocation.

3. The system of claim 1, wherein said communication handler transmits a notification request in response to said reallocation.

4. The system of claim 1, wherein said threshold number is a number of notification requests stored in another communication handler.

5. The system of claim 1, wherein said communication handler is configured to simultaneously transmit a plurality of notification messages across a plurality of communication lines.

6. The system of claim 1, further comprising:

a database storing route information associated with a plurality of vehicles, said route information including said first time value,

wherein said route handler is configured to determine whether said first time value is associated with a notification event that is expected to occur within a particular time period and to transmit said first time value to said schedule monitor in response to a determination that said notification event associated with said first time value is expected to occur within said particular time period.

7. The system of claim 1, wherein said route handler is further configured to produce a list of notification events that are expected to occur within a particular time period, said route handler further configured to include said first time value in said list in response to a determination that said first time value is associated with a notification event that is expected to occur within said particular time period, said schedule monitor further configured to analyze said list to determine whether any notification requests should be transmitted to said communication handler.

8. The system of claim 1, wherein said schedule monitor is implemented within a first computer system and said communication handler is implemented within a second computer system.

9. A system for notifying users of impending arrivals of vehicles at particular locations, comprising:

a database storing data associated with a plurality of vehicles;

a route handler configured to analyze said data and to select portions of said data that are associated with notification events expected to occur during a particular time period;

US 6,317,060 B1

17

a schedule monitor configured to analyze said selected portions of said data during said particular time period and to disregard other portions of said data during said particular time period, said schedule monitor further configured to determine when at least one of said notification events should occur based on said selected portions of said data and to transmit a notification request in response to a determination by said schedule monitor that said at least one notification event should occur; and

a communication handler configured to receive said notification request and to transmit a notification message in response to said notification request.

10. The system of claim 9, wherein said communication handler is configured to simultaneously transmit a plurality of notification messages across a plurality of communication lines.

11. The system of claim 9, wherein said communication handler is configured to store said notification request and to determine a number of notification requests stored by said communication handler, said communication handler further configured to compare said number of notification requests to a threshold number and to cause reallocation of notification requests between said communication handler and at least one other communication handler based on a comparison of said number of notification requests to said threshold number.

12. The system of claim 9, wherein said schedule monitor is implemented in a first computer system and said communication handler is implemented in a second computer system.

13. A system for notifying users of impending arrivals of vehicles at particular locations, comprising:

memory storing data indicating a proximity of at least one vehicle to at least one location;

a route handler configured to receive status messages and to update said data based on said status messages;

a schedule monitor configured to monitor said data and to transmit notification requests in response to determinations by said schedule monitor that said at least one vehicle is within a predefined proximity of at least one location; and

a plurality of communication handlers configured to respectively receive said notification requests and to transmit notification messages in response to said notification requests,

wherein said schedule monitor is further configured to determine a number of notification requests transmitted to one of said communication handlers within a first particular time period and to allocate said notification requests between said communication handlers based on said number.

14. The system of claim 13, wherein at least one of said communication handlers is configured to store notification requests and to determine a number of notification requests stored by said at least one communication handler, said at least one communication handler further configured to compare said number of notification requests to a threshold number and to cause reallocation of notification requests between said communication handler and another of said communications handlers based on a comparison of said number of notification requests to said threshold number.

15. The system of claim 13, wherein said route handler selects said data in response to a determination by said route

18

handler that said data is associated with notification events that are expected to occur during a second particular time period.

16. A method for notifying users of impending arrivals of vehicles at particular locations, comprising the steps of:

storing a first time value, said first time value indicating when a user should be notified of an impending arrival of a vehicle;

receiving a second time value;

receiving a status message transmitted from said vehicle; updating said first time value based on said status message;

comparing said first time value to said second time value; transmitting a notification request to a communication handler based on said comparing said first time value step;

determining a number of notification requests stored by a communication handler;

comparing said number of notification requests to a threshold number;

reallocating said notification request between said communication handlers based on said comparing said number of notification requests step; and

transmitting a notification message to said user in response to said notification request.

17. The method of claim 16, further comprising the steps of:

determining whether said first time value indicates a time within a particular time period, said particular time period including a time indicated by said second time value; and

performing said comparing said first time value step during said particular time period in response to a determination in said determining step that said first time value indicates a time within said particular time period.

18. The method of claim 16, further comprising the steps of:

creating a list of notification events that are expected to occur within a particular time period;

including said first time value in said list in response to a determination that said first time value is associated with a notification event that is expected to occur within said particular time period; and

monitoring said list during said particular time period, said monitoring step including said comparing said first time value step.

19. A method for notifying users of impending arrivals of vehicles at particular locations, comprising the steps of:

storing data associated with a plurality of vehicles;

selecting portions of said data that are associated with notification events expected to occur during a particular time period;

analyzing said selected portions of said data during said particular time period;

disregarding other portions of said data during said particular time period;

determining when at least one of said notification events should occur based on said analyzing step; and

transmitting a notification message in response to said determining step.

20. A method for notifying users of impending arrivals of vehicles at particular locations, comprising the steps of:

US 6,317,060 B1

19

storing data associated with at least one vehicle;
receiving at least one status message from said one
vehicle;
updating said data based on said one status message;
analyzing said data;
determining when to notify a user of an impending arrival
of said one vehicle at a particular location based on said
analyzing step;
transmitting a notification request based on said deter-
mining step; and
allocating said notification request to a communication
handler based on a number of notification requests
transmitted to said communication handler during a
first particular time period.

21. The method of claim 20, further comprising the step
of transmitting a notification message from said communi-
cation handler in response to said notification request, said
notification message indicating said impending arrival of
said one vehicle.

20

22. The method of claim 20, further comprising the steps
of:
storing said notification request in said communication
handler;
determining a number of notification requests stored in
said communication handler;
comparing said number of notification requests to a
threshold number;
transmitting said notification request to another handler
based on said comparing step; and
transmitting a notification message from said other com-
munication handler in response to said notification
request, said notification message indicating said
impending arrival of said one vehicles.

23. The method of claim 20, further comprising the step
of selecting said data in response to a determination that said
data is associated with notification events that are expected
to occur during a second particular time period.

* * * * *

(12) **United States Patent**
Jones

(10) **Patent No.: US 6,415,207 B1**
 (45) **Date of Patent: Jul. 2, 2002**

- (54) **SYSTEM AND METHOD FOR AUTOMATICALLY PROVIDING VEHICLE STATUS INFORMATION**
- (75) Inventor: **Martin Kelly Jones**, Vancouver (CA)
- (73) Assignee: **Global Research Systems, Inc.**, Rome, GA (US)
- (*) Notice: Subject to any disclaimer, the term of this patent is extended or adjusted under 35 U.S.C. 154(b) by 0 days.

5,351,194 A	9/1994	Ross et al.	455/456
5,381,338 A	1/1995	Wysocki et al.	701/207
5,394,332 A	2/1995	Kuwahara et al.	701/211
5,400,020 A	3/1995	Jones	340/994
5,420,794 A	5/1995	James	701/117
5,444,444 A	8/1995	Ross	340/994
5,461,374 A	10/1995	Lewiner et al.	340/994
5,493,295 A	2/1996	Lewiner et al.	340/994
5,515,421 A	5/1996	Sikand et al.	379/88.21
5,519,621 A	5/1996	Wortham	455/99
5,539,810 A	7/1996	Kennedy, III et al. ...	379/88.25

(List continued on next page.)

FOREIGN PATENT DOCUMENTS

FR	2 559 930	8/1985	G08G/1/12
FR	2674355	9/1992	G08G/1/123
JP	52066175	6/1977		
JP	63288400	11/1988	G08G/1/12

Primary Examiner—William A. Cuchlinski, Jr.
Assistant Examiner—Marthe Y. Marc-Coleman
 (74) *Attorney, Agent, or Firm*—Thomas, Kayden, Horstemeier & Risley, LLP

(57) **ABSTRACT**

A system for monitoring and reporting vehicle status information includes a database, a communication interface, and a system manager. The database stores status information associated with a vehicle, and the communication interface is designed to communicate with communication devices remotely located from the system. The system manager receives a message transmitted from the vehicle and updates the status information stored in the database based on the received message. When a remote communication device establishes communication with the communication interface, the communication interface receives caller identification information automatically transmitted to the communication interface. The system manager analyzes this caller identification information and automatically retrieves status information from the database based on the caller identification information. The system manager then transmits, via the communication interface, the retrieved status information to the remote communication device.

15 Claims, 3 Drawing Sheets

(21) Appl. No.: **09/516,476**

(22) Filed: **Mar. 1, 2000**

Related U.S. Application Data

- (60) Provisional application No. 60/122,482, filed on Mar. 1, 1999.
- (51) **Int. Cl.**⁷ **G05D 1/00**
- (52) **U.S. Cl.** **701/1; 701/29; 701/35; 701/117; 342/357.06; 342/357.12**
- (58) **Field of Search** **701/29, 35, 117, 701/1, 200, 204; 342/357.06, 357.12; 340/994**

(56) **References Cited**

U.S. PATENT DOCUMENTS

3,644,883 A	2/1972	Borman et al.	340/991
3,845,289 A	10/1974	French	701/117
4,297,672 A	10/1981	Fruchey et al.	340/994
4,325,057 A	4/1982	Bishop	340/994
4,791,571 A	12/1988	Takahashi et al.	701/117
4,812,843 A	3/1989	Champion, III et al.	340/905
4,924,496 A	* 5/1990	Figa et al.	378/173
4,956,777 A	9/1990	Cearley et al.	701/24
5,021,780 A	6/1991	Fabiano et al.	340/994
5,113,185 A	5/1992	Ichikawa	340/995
5,122,959 A	6/1992	Nathanson et al.	701/117
5,131,020 A	7/1992	Liebesny et al.	455/422
5,168,451 A	12/1992	Bolger	701/117
5,218,629 A	6/1993	Dumond, Jr. et al.	455/412
5,223,844 A	6/1993	Mansell et al.	342/357.07
5,299,132 A	3/1994	Wortham	455/457
5,323,456 A	6/1994	Oprea	379/375

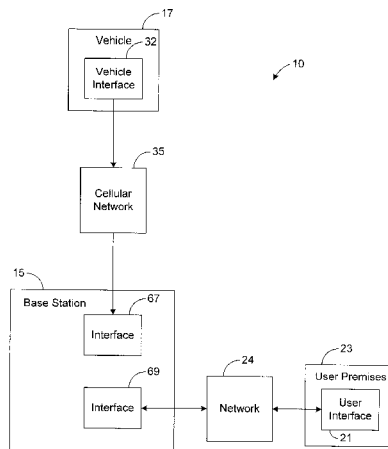

US 6,415,207 B1

Page 2

U.S. PATENT DOCUMENTS

5,544,225 A	8/1996	Kennedy, III et al.	455/412	5,699,275 A	12/1997	Beasley et al.	709/221
5,546,444 A	8/1996	Roach, Jr. et al.	455/412	5,719,771 A	2/1998	Buck et al.	455/456
5,579,376 A	11/1996	Kennedy, III et al.	455/411	5,732,074 A	3/1998	Spaur et al.	370/313
5,587,715 A	12/1996	Lewis	342/357.03	5,736,940 A	4/1998	Burgener	340/994
5,590,178 A	* 12/1996	Murakami et al.	379/96	5,751,245 A	5/1998	Janky et al.	342/357
5,594,650 A	1/1997	Shah et al.	701/207	5,758,313 A	* 5/1998	Shah et al.	455/456
5,623,260 A	4/1997	Jones	340/994	5,760,742 A	6/1998	Branch et al.	342/457
5,648,770 A	7/1997	Ross	340/994	5,771,455 A	6/1998	Kennedy, III et al.	455/456
5,652,707 A	7/1997	Wortham	455/456	RE35,920 E	10/1998	Sorden et al.	342/457
5,657,010 A	8/1997	Jones	340/994	5,929,752 A	* 7/1999	Janky et al.	340/426
5,668,543 A	9/1997	Jones	340/994	6,006,159 A	12/1999	Schmier et al.	701/200
5,673,305 A	9/1997	Ross	455/517	6,094,477 A	* 7/2000	Nada et al.	379/93.24
5,694,322 A	12/1997	Westerlage et al.	705/417	6,166,626 A	* 12/2000	Janki et al.	340/426

* cited by examiner

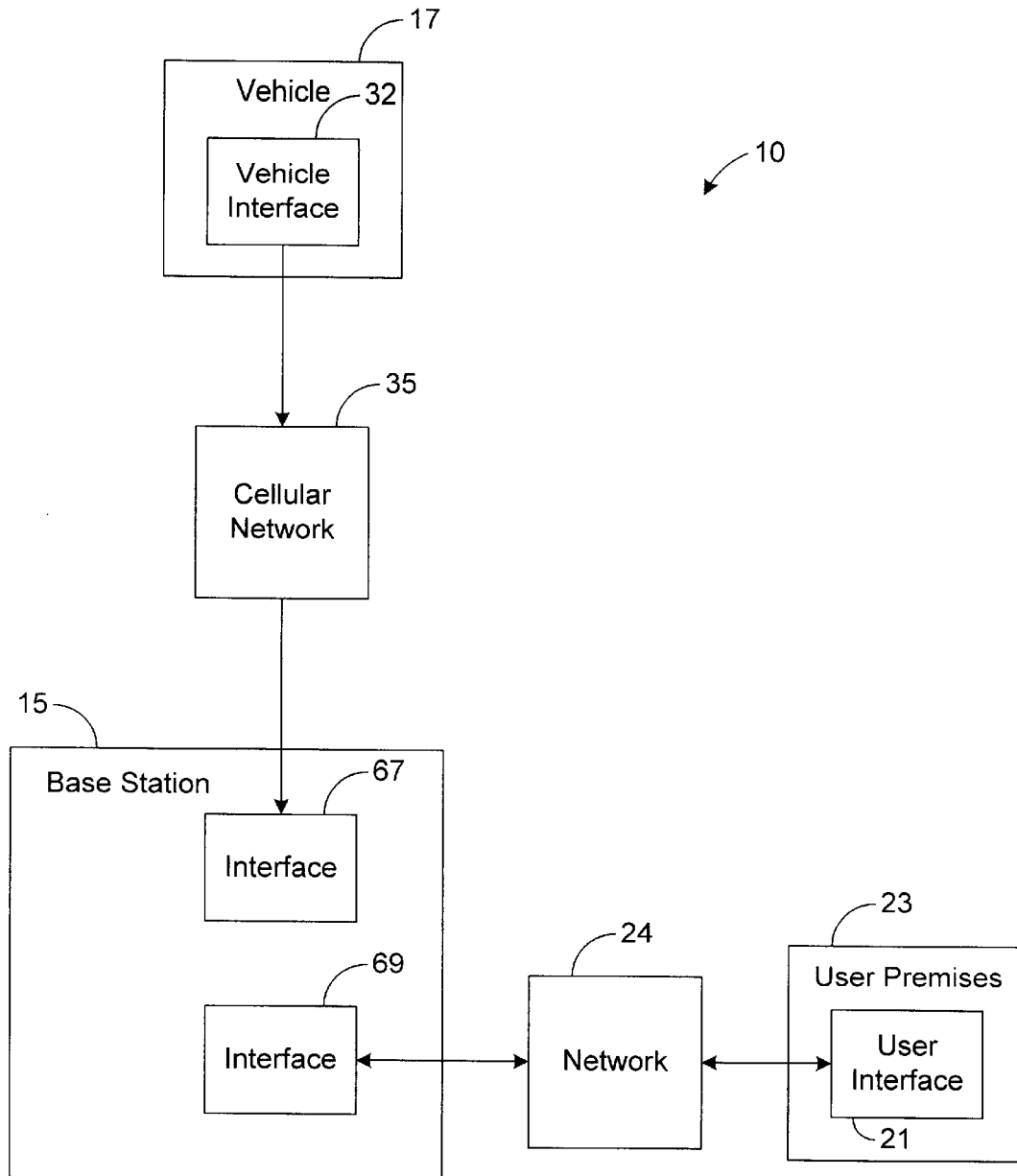

FIG. 1

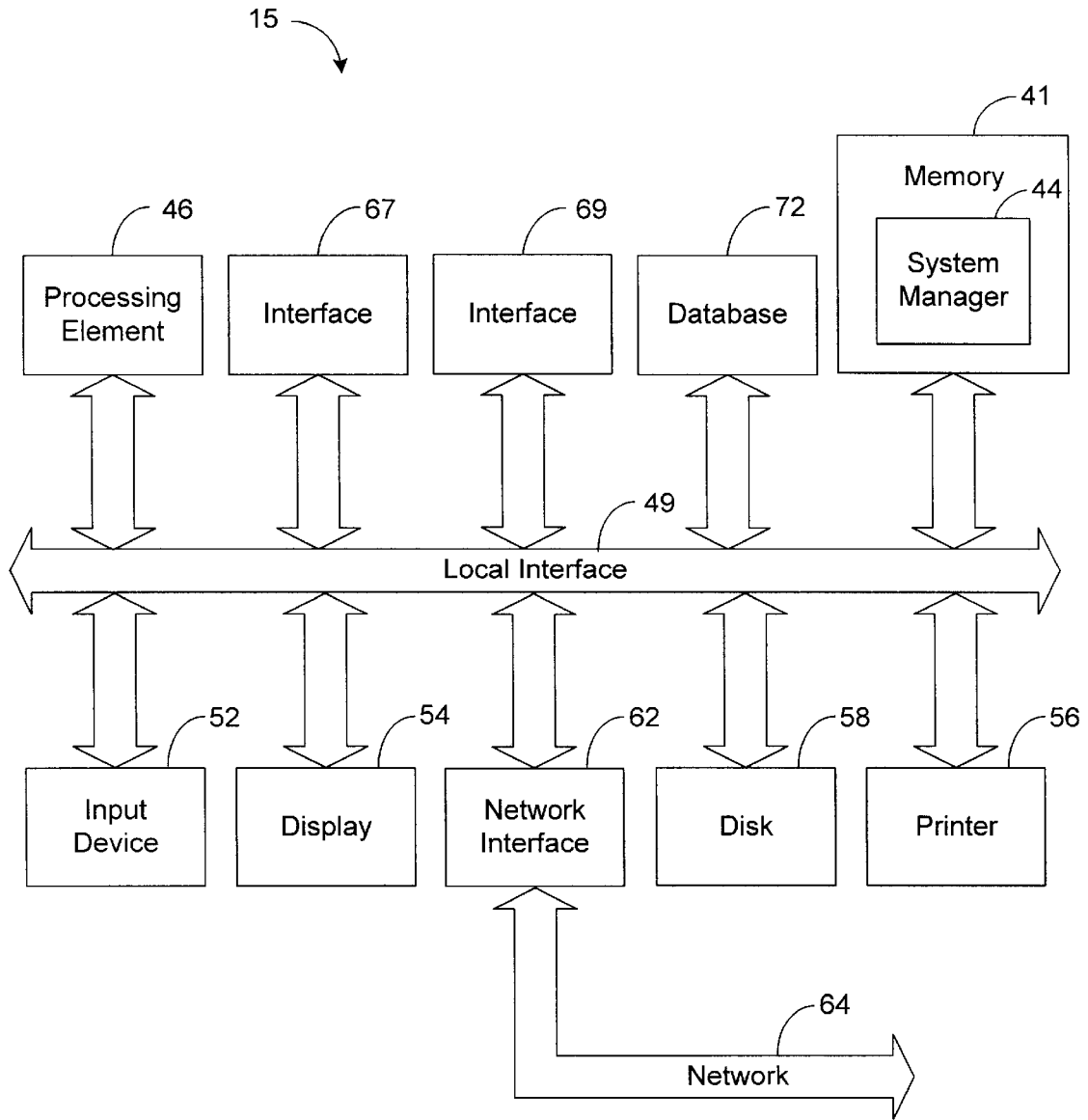

FIG. 2

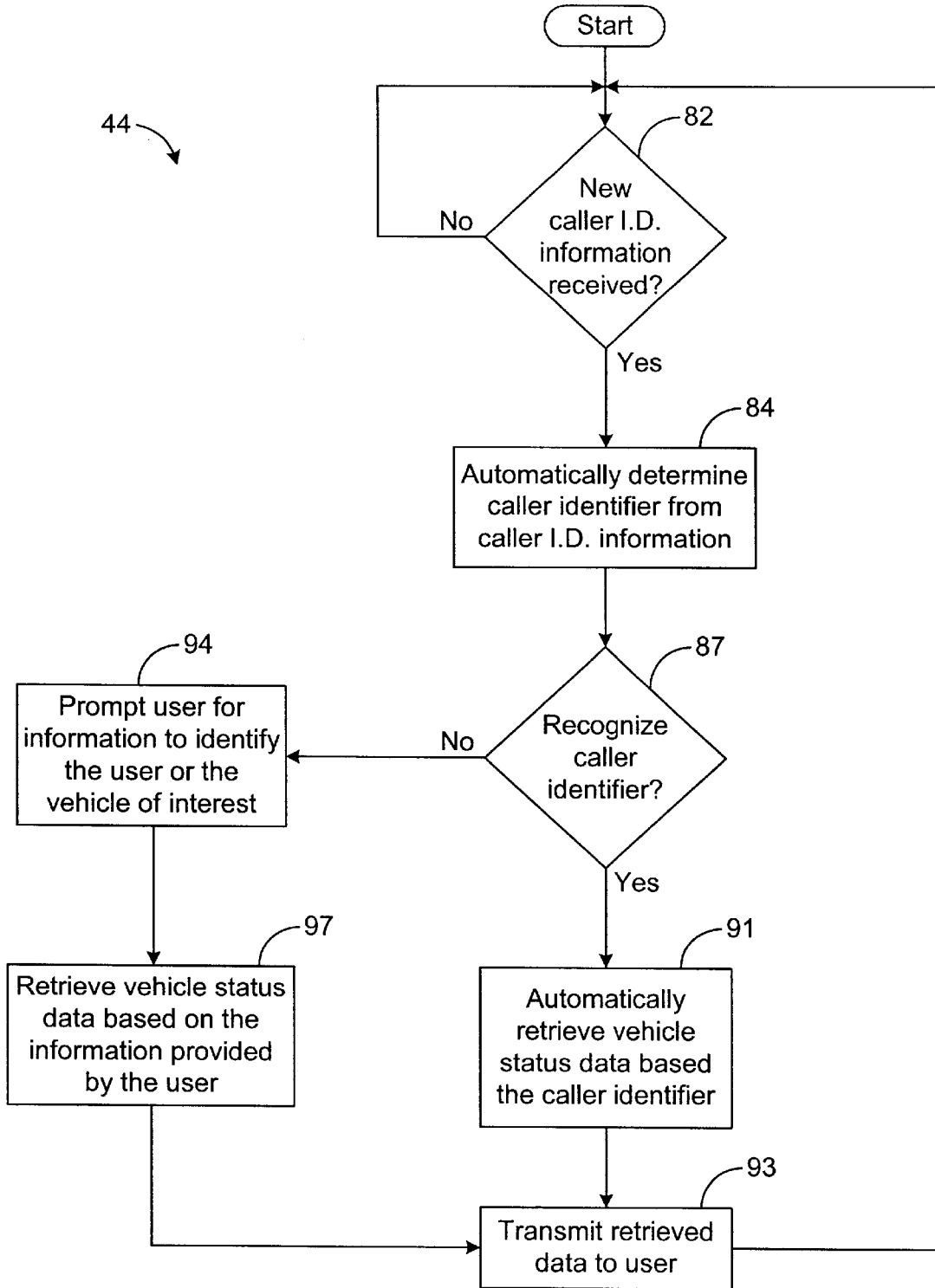

FIG. 3

US 6,415,207 B1

1

SYSTEM AND METHOD FOR AUTOMATICALLY PROVIDING VEHICLE STATUS INFORMATION

CROSS-REFERENCE TO RELATED APPLICATION

This application claims priority to and the benefit of the filing date of U.S. Provisional Application Serial No. 60/122,482, filed on Mar. 1, 1999, and entitled "Base Station Apparatus and Method for Monitoring Travel of Mobile Vehicle."

BACKGROUND OF THE INVENTION

1. Field of the Invention

The present invention generally relates to vehicle information systems and, in particular, to a system and method for maintaining vehicle status information and of automatically and efficiently providing this information to users after communication is established with the users.

2. Related Art

Presently, it is possible for users to call a central processing station to obtain information on the status of a vehicle of interest. For example, it is possible for a user to call an airline or a bus depot and find out whether an airplane or bus is on or off schedule. In some situations a human operator at the processing station (e.g., the airline or bus depot) receives the call from the user who asks the operator for information regarding the status of a particular vehicle. The operator then looks up the status of the vehicle from a chart or database and provides the user with the requested information.

In other situations, the status information is automatically provided to the user after the user has submitted a status information request, thereby eliminating the need of human interaction at the processing station. For example, once communication with a communications device at the processing station is established, a computer at the processing station may prompt the user to identify which vehicle the user is interested in. The user may enter a vehicle identifier, such as an airplane number or bus number, for example, via touch-tone signaling or other suitable technique for interfacing information with computer systems. The computer then automatically retrieves information pertaining to the status of the vehicle identified by the user's inputs and provides this information to the user.

Having to provide either the operator or the computer with information identifying which vehicle is of interest to the user is timing consuming and burdensome. It would be desirable for the processing station to automatically provide the user with status information on a particular vehicle without the user having to provide a vehicle identifier.

Thus, a heretofore unaddressed need exists in the industry for providing a system and method of maintaining vehicle status information and of automatically and efficiently providing users with this information.

SUMMARY OF THE INVENTION

The present invention overcomes the inadequacies and deficiencies of the prior art as discussed hereinbefore. Generally, the present invention provides a system and method for automatically providing a user with vehicle status information related to a particular vehicle or a particular set of vehicles.

In architecture, the system of the present invention utilizes a database, a communication interface, and a system

2

manager. The database stores status information associated with a vehicle, and the communication interface is designed to communicate with communication devices remotely located from the system. The system manager receives a message transmitted from the vehicle and updates the status information stored in the database based on the received message. When a remote communication device establishes communication with the communication interface, the communication interface receives caller identification information automatically transmitted to the communication interface. The system manager analyzes this caller identification information and automatically retrieves status information from the database based on the caller identification information. The system manager then transmits, via the communication interface, the retrieved status information to the remote communication device.

The present invention can also be viewed as providing a method for monitoring and reporting status of vehicles. The method can be broadly conceptualized by the following steps: maintaining status information associated with a vehicle; communicating with a remote communication device; receiving caller identification information automatically transmitted in the communicating step; and automatically retrieving and transmitting the status information based on the caller identification information.

Other features and advantages of the present invention will become apparent to one skilled in the art upon examination of the following detailed description, when read in conjunction with the accompanying drawings. It is intended that all such features and advantages be included herein within the scope of the present invention and protected by the claims.

BRIEF DESCRIPTION OF THE DRAWINGS

The invention can be better understood with reference to the following drawings. The elements of the drawings are not necessarily to scale relative to each other, emphasis instead being placed upon clearly illustrating the principles of the invention. Furthermore, like reference numerals designate corresponding parts throughout the several views.

FIG. 1 is a block diagram illustrating a system for monitoring and reporting status of vehicles in accordance with the present invention.

FIG. 2 is a block diagram illustrating a computer system implementing a base station depicted in FIG. 1.

FIG. 3 is a flow chart illustrating the architecture and functionality of a system manager depicted in FIG. 2.

DETAILED DESCRIPTION OF THE PREFERRED EMBODIMENT

FIG. 1 depicts a vehicle tracking system **10** in accordance with the preferred embodiment of the present invention. The system **10** includes a base station **15** configured to store information regarding the status of at least one vehicle **17**. For example, the base station **15** may store a value indicating the time that the vehicle **17** is expected to arrive at a particular location.

The base station **15** is configured to communicate with a user interface **21** at a user's premises **23** via a communications network **24**, such as the publicly switched telephone network (PSTN), for example. In this regard, the base station **15** may be configured to determine when the vehicle **17** is within a predetermined proximity (e.g., time or distance) from a particular location and to transmit a notification message to the user interface **21** to warn a user at the

premises **23** of an impending arrival of the vehicle **17** at the particular location. A base station **15** capable of tracking vehicle **17** and of transmitting such a notification message is fully described in U.S. Patent Application entitled “Base Station Apparatus and Method for Monitoring Travel of a Mobile Vehicle,” assigned Ser. No. 09/395,501, and filed on Sep. 14, 1999, which is incorporated herein by reference.

The notification message can be transmitted via a telephone call, a page, an e-mail message, or any other suitable technique for communicating data. The user interface **21** is preferably any communication device or devices capable of communicating with base station **15** and, therefore, of receiving and processing the notification message. For example, the user interface **21** may be a telephone, a pager, a modem, or other suitable communication device.

In the preferred embodiment, the user interface **21** may be configured to establish communication with the base station **15** to discover the status of a particular vehicle **17**. Once communication with the base station **15** is established, the base station **15** is configured to automatically identify the user associated with the user interface **21** without prompting the user for inputs.

For example, in conventional telephony systems, caller identification (caller I.D.) information, such as the caller’s telephone number, name, address, etc., is often automatically transmitted to the party receiving the call so that the party receiving the call can identify the caller before answering. U.S. Pat. No. 4,924,496, entitled “Automatic Incoming Telephone Call Originating Number and Party Display System” and issued on May 8, 1990, which is incorporated herein by reference, describes a process of automatically transmitting caller I.D. information without prompting the caller for inputs. The base station **15** is designed to utilize this caller I.D. information to identify the user at premises **23** that established communication with base station **15**.

Furthermore, the base station **15** is preferably aware of which users are associated with which vehicles **17**. Accordingly, after identifying the user who established communication with the base station **15**, the base station **15** is configured to automatically retrieve status information pertaining to the vehicle or vehicles **17** associated with the user and to transmit this information to the user interface **21**, which interfaces this information with the user at premises **23**. Therefore, the user is able to receive status information pertaining to a vehicle **17** associated with the user without having to manually provide inputs to the base station **15** to identify the associated vehicle **17**.

To ensure that the information provided to the user is accurate, the base station **15** is designed to update the status information stored in the base station **15**, when the vehicle **17** is unexpectedly late or early. In this regard, the vehicle **17** includes a vehicle interface **32** capable of communicating with the base station **15** via wireless signals. For example, in the preferred embodiment, the vehicle interface **32** may comprise a cellular telephone capable of transmitting wireless signals to base station **15** via a cellular network **35**. However, in other embodiments, the vehicle interface **32** may be comprised of another device or devices capable of communicating with the base station **15** either directly or through another type of network.

When the vehicle **17** is off schedule or when another event pertaining to the status of the vehicle **17** occurs, a status message is transmitted to the base station **15** to notify the base station **15** of the event. The status message may be manually interfaced with vehicle interface **32** via buttons or switches, for example, or may be automatically generated by

the vehicle interface **32**. U.S. Patent Application entitled “Apparatus and Method for Monitoring Travel of a Mobile Vehicle,” assigned Ser. No. 09/395,497, and filed on Sep. 14, 1999, which is incorporated herein by reference, describes a system in which a status message is automatically transmitted when the vehicle **17** is off schedule.

The base station **15** is configured to receive the status message and to update the status information stored in the base station **15** in response to the status message. Therefore, the status information stored in the base station **15** should be accurate and up to date.

FIG. **2** depicts a more detailed view of the base station **15**. In the embodiment shown by FIG. **2** the base station **15** is implemented as a computer having memory **41**. The base station **15** preferably includes a system manager **44** that controls the operation of the base station **15**. The system manager **44** can be implemented in software, hardware, or a combination thereof. In the preferred embodiment, as illustrated by way of example in FIG. **2**, the system manager **44** of the present invention along with its associated methodology is implemented in software and stored in memory **41**.

Note that the system manager **44**, when implemented in software, can be stored and transported on any computer-readable medium for use by or in connection with an instruction execution system, apparatus, or device, such as a computer-based system, processor-containing system, or other system that can fetch the instructions from the instruction execution system, apparatus, or device and execute the instructions. In the context of this document, a “computer-readable medium” can be any means that can contain, store, communicate, propagate, or transport the program for use by or in connection with the instruction execution system, apparatus, or device. The computer readable medium can be, for example but not limited to, an electronic, magnetic, optical, electromagnetic, infrared, or semiconductor system, apparatus, device, or propagation medium. More specific examples (a nonexhaustive list) of the computer-readable medium would include the following: an electrical connection (electronic) having one or more wires, a portable computer diskette (magnetic), a random access memory (RAM) (magnetic), a read-only memory (ROM) (magnetic), an erasable programmable read-only memory (EPROM or Flash memory) (magnetic), an optical fiber (optical), and a portable compact disc read-only memory (CDROM) (optical). Note that the computer-readable medium could even be paper or another suitable medium upon which the program is printed, as the program can be electronically captured, via for instance optical scanning of the paper or other medium, then compiled, interpreted or otherwise processed in a suitable manner if necessary, and then stored in a computer memory. As an example, the system manager **44** may be magnetically stored and transported on a conventional portable computer diskette.

The preferred embodiment of the base station **15** of FIG. **2** also comprises one or more conventional processing elements **46**, such as a digital signal processor (DSP), that communicate to and drive the other elements within the base station **15** via a local interface **49**, which can include one or more buses. Furthermore, an input device **52**, for example, a keyboard or a mouse, can be used to input data, and screen display **54** or a printer **56** can be used to output data to the user. A disk storage mechanism **58** can be connected to the local interface **49** to transfer data to and from a nonvolatile disk (e.g., magnetic, optical, etc.). The base station **15** can be connected to a network interface **62** that allows the base station **15** to exchange data with a network **64**.

The base station **15** also includes an interface **67** for communicating with vehicle interface **32** (FIG. **1**) and an

US 6,415,207 B1

5

interface 69 for communicating with user interface 21. Interfaces 67 and 69 may be implemented by the same device or devices or may be implemented by a separate device or devices.

The base station 15 preferably stores status information in a database 72. In this regard, the database 72 preferably includes a plurality of entries, in which each entry includes status information associated with a particular vehicle 17. For example, an entry may include a data value indicating when a vehicle 17 is expected to arrive at a particular location or indicating whether the vehicle is on schedule. The status information stored in the entry may also define the aforementioned particular location or may include data identifying the packages or passengers, if any, on board the vehicle. Other types of information pertaining to the status of the vehicle 17 may be stored in the entry.

Each entry is preferably correlated with a vehicle identifier that identifies the vehicle 17 described by the status information stored within the entry. Furthermore, the status message may include the vehicle identifier of the vehicle 17 that transmitted the message. Therefore, when a status message is received by the base station 15, the system manager 44 may identify which entries in the database 72 include information that potentially should be updated based on the status message.

Each entry is also correlated with at least one user identifier identifying a user associated with the vehicle 17 described by the information stored in the entry. For example, assume that a user is a passenger scheduled to ride on a particular vehicle 17. At least one of the entries in the database 72 should include information pertaining to the status of the particular vehicle 17 (e.g., indicating whether the particular vehicle 17 is on or off schedule). This entry should be correlated with a user identifier that identifies the foregoing user. Accordingly, when the system manager 44 determines that this user has established communication with the base station 15, the system manager 44 is configured to automatically identify, based on the user identifiers correlated with the entries, each entry associated with the user. Therefore, when the user establishes communication with the interface 69 in the foregoing example, the system manager 44 is configured to automatically identify the aforementioned entry having status information pertaining to the particular vehicle 17 that the user is to ride.

After identifying the entry or entries associated with the user, the system manager 44 is configured to retrieve the status information from the identified entry or entries and to transmit this information to the user. As a result, the user does not need to manually provide inputs to identify which information the system manager 44 should retrieve and transmit to the user.

It should be noted that other methodologies for storing status information and of associating the status information with the appropriate vehicles 17 and users may be employed without departing from the principles of the present invention.

Operation

The preferred use and operation of the system 10 and associated methodology are described hereafter.

Assume for illustrative purposes that a user wishes to ride a vehicle 17 associated with the system 10. Assume further that an entry in the database 72 is associated with this vehicle 17. For example, assume that the entry indicates when the vehicle 17 is expected to arrive at a location, such as the location where the user is to meet the vehicle 17, for example.

6

At some point, a user identifier identifying the user is correlated with entry. For example, during a registration period, the user may provide his or her telephone number, which is stored in the database 72 and correlated with the entry in the database 72 associated with the vehicle 17. However, it should be noted that other types of user identifiers may be used. For example, the user identifier may be the user's name, the user's home or business address, the user's e-mail address, or other types of values that identify the user.

If the vehicle 17 is early or late, then it may be desirable for the user to change the time at which he or she leaves to meet the vehicle 17. Therefore, before the user travels to the aforementioned location to meet the vehicle 17, it may be desirable for the user to check the status of the vehicle 17 to find out if the vehicle 17 is off schedule. To check the status of the vehicle 17, the user establishes communication with the base station 15 via user interface 21. For example, in the preferred embodiment, the user utilizes interface 21 to establish a telephone call with the interface 69 at the base station 15. In this example, both interfaces 21 and 69 are conventional telephone devices.

The interface 69 is designed to receive caller I.D. information that is automatically transmitted to the interface 69 when communication with the interface 69 is being established. In telephony systems the caller I.D. information is usually transmitted between the ringing signals transmitted to the interface 69, and the caller I.D. information usually includes the telephone number associated with the user interface 21.

Once the interface 69 has received the caller I.D. information, the system manager 44 automatically searches the caller I.D. information for a caller identifier (e.g., the telephone number provided in the caller I.D. information), as shown by blocks 82 and 84 of FIG. 3. The caller identifier is information in the caller identification information used by the base station 15 to identify a caller. In the preferred embodiment where the user identifier stored in database 72 is the user's telephone number, the system manager 44 searches the caller I.D. information in block 84 for the telephone number defined by the caller I.D. information. This telephone number should be the telephone number associated with interface 21.

After determining the caller identifier from the caller I.D. information, the system manager 44 then searches the database 72 to determine whether the caller identifier corresponds with one of the user identifiers already stored in the database 72, as shown by block 87. For example, in the preferred embodiment, the system manager 44 compares the telephone number included in the caller identification information to the user identifiers stored in the database 72. As long as the user is calling from an interface 21 associated with the same telephone number provided during registration (i.e., the telephone number used by the base station 15 as the user identifier to identify the user), then the telephone number included in the caller I.D. information should correspond to (e.g., match) the user identifier associated with the user.

If a correspondence with a user identifier is determined in block 87, then the system manager 44 automatically retrieves the entry correlated with the user identifier, as shown by block 91. This entry should be the entry having status information pertaining to the vehicle 17 of interest to the user (e.g., the vehicle 17 that the user is planning to ride). The system manager 44 then transmits at least a portion of the retrieved status information to the user via interfaces 21 and 69, as depicted by block 93.

The status information transmitted to user interface 21 preferably indicates whether the aforementioned vehicle 17 is on or off schedule, although other types of information may be indicated by the status information. Note that this status information is provided to the user without the user having to provide any inputs once communication with the interface 69 is established. In this regard, the user merely dials the telephone number associated with the interface 69 in the preferred embodiment, and based on the caller I.D. information automatically provided to the interface 69, the system manager 44 retrieves and transmits the aforementioned status information to the user interface 21. Based on the status information transmitted to the user interface, the user should be able to determine whether the vehicle 17 is on or off schedule.

It should be noted that the base station manager 44 may fail to find a corresponding user identifier in the database 72 in some circumstances. For example, the user may call from an interface 21 associated with a telephone number other than the one provided during registration and, therefore, other than the one used by the base station 15 as a user identifier for the user. In such a situation, the system manager 44 should prompt the user to enter sufficient information so that the system manager 44 can either identify the user or the vehicle 17 of interest, as shown by block 94. For example, the system manager 44 could prompt the user to enter, via touch tone signaling, the user's telephone number or the vehicle number of the vehicle 17 of interest to the user. In this situation, the system manager 44 retrieves the status information from the database 72 based on the inputs provided by the user instead of the caller identifier included in the caller I.D. information, as shown by block 97.

Although the foregoing example has been described herein as utilizing a telephone call to establish communication with the interface 69, the present invention should not be so limited. Any device capable of establishing communication with the interface 69 and of automatically transmitting caller I.D. information to the interface 69 should be suitable for implementing the user interface 21 of the present invention. For example, it is possible for the user interface 21 to establish communication with interface 69 over the Internet. In this example, the user identifier identifying the user could be the user's e-mail or source address. Therefore, upon receiving an e-mail message from interface 21, the system manager 44 in block 84 searches for the sender's e-mail address. This e-mail address is compared with the user identifiers in the database 72 in block 87 to identify the status information that should be transmitted to the user in a return e-mail message. There are various other devices and techniques that may be employed for communicating between interfaces 69 and 23 without departing from the principles of the present invention.

It should be emphasized that the above-described embodiments of the present invention, particularly, any "preferred" embodiments, are merely possible examples of implementations, merely set forth for a clear understanding of the principles of the invention. Many variations and modifications may be made to the above-described embodiment(s) of the invention without departing substantially from the spirit and principles of the invention. All such modifications and variations are intended to be included herein within the scope of the present invention and protected by the claims.

What is claimed is:

1. A system for monitoring and reporting status of vehicles, comprising:
 - a database storing status information associated with a vehicle, said status information indicative of a current proximity of said identified vehicle;

a communication interface configured to communicate with communication devices remotely located from said system; and

a system manager configured to receive a message transmitted from said vehicle and to update said status information based on said message, said system manager further configured to analyze caller identification information automatically transmitted to said communication interface when a remote communication device establishes communication with said communication interface, said system manager further configured to automatically search for and locate a set of said status information based on said caller identification information, said system manager further configured to retrieve said set of status information and to transmit said retrieved set of status information to said remote communication device.

2. The system of claim 1, wherein said caller identification information is a telephone number associated with said remote communication device.

3. The system of claim 1, wherein said caller identification information is included within a message transmitted over the internet and received by said communication interface, and wherein said caller identification information is a source address automatically inserted into said message by said remote communication device, said source address identifying an address of said remote communication device.

4. The system of claim 1, wherein said system manager is configured to transmit said retrieved set of status information to said remote communication device in response to said caller identification information.

5. A system for monitoring and reporting status of vehicles, comprising:

means for maintaining status information associated with a vehicle, said status information indicative of a current proximity of said identified vehicle;

means for communicating with a remote communication device, said means for communicating including a means for receiving caller identification information automatically transmitted to said communicating means;

means for utilizing said caller identification information to automatically search for and locate a set of said status information; and

means for automatically retrieving and transmitting said set of said status information.

6. The system of claim 5, wherein said caller identification information is a telephone number.

7. The system of claim 5, wherein said caller identification information is an e-mail address.

8. The system of claim 5, further comprising:

means for receiving a status message transmitted from said vehicle; and

means for updating said status information based on said status message.

9. The system of claim 5, wherein said status information indicates a proximity of said vehicle from a particular location.

10. A method for monitoring and reporting status of vehicles, comprising the steps of:

maintaining status information associated with a vehicle, said status information indicative of a current proximity of said vehicle;

communicating with a remote communication device; receiving caller identification information automatically transmitted in said communicating step;

US 6,415,207 B1

9

utilizing said caller identification information to automatically search for and locate a set of said status information;

automatically retrieving said set of status information based on said searching for and locating step; and
5 transmitting said retrieved set of status information to said remote communication device.

11. The method of claim **10**, wherein said caller identification information is a telephone number.

12. The method of claim **10**, wherein said caller identification information is an e-mail address.

13. The method of claim **10**, further comprising the steps of:

10

receiving a status message transmitted from said vehicle; and

updating said status information based on said status message.

14. The method of claim **10**, further comprising the step of indicating a proximity of said vehicle from a particular location via said status information.

15. The method of claim **10**, wherein said utilizing, retrieving, and transmitting steps are performed in response to said receiving step.

* * * * *

How does it work?

Beacons are small wireless devices that broadcast signals using Bluetooth Low Energy (BLE) or Bluetooth SMART technology. Beacons are placed on equipment, cargo containers and in warehouses. When assets move and come in range of our dedicated logistics app, the app detects the asset and captures data indicating the assets exact location and time of arrival. The data generated is translated into powerful reports and maps viewed from the management console that will help you locate and manage your assets. The app then facilitates mobile interactions such as inventory details, safety and handling information.

[Find out more about beacon technology](#)



Transforming logistics management

Our all-inclusive logistics and asset management solution helps you increase your asset utilization, prevent theft and optimize your distribution routes.



ASSET FINDER

Quickly locate an asset across a facility.



ASSET TRACKING

Track cargo and assets as they enter and exit a location.



INVENTORY MANAGEMENT

Assign inventory information and unique identifiers to cargo. Order additional supplies from your mobile device.



PRODUCT INFORMATION & TRAINING

Present product and inventory information to mobile device on arrival.



SENSOR-ENABLED MONITORING

Monitor and store information on temperature, motion and other relevant sensors



DISTRIBUTION REPORTING & ANALYTICS

Access real-time and historical reporting on asset and inventory usage, distribution times and inventory leakage across locations

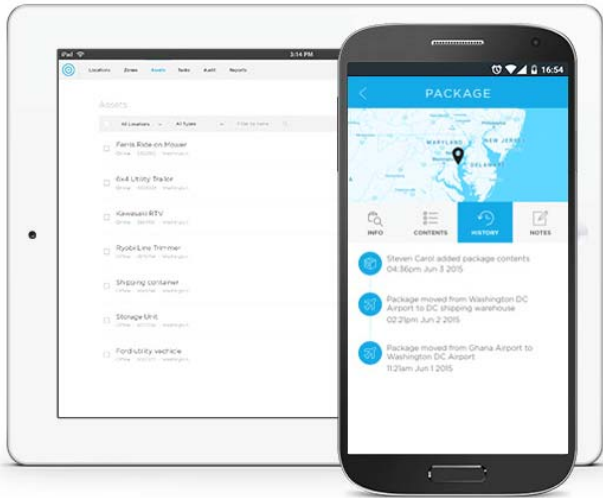

Digitize your workflow

Replace manual or paper-based manifests with dynamic forms presented at the right time, right place, and to the right employee.

- Create digital manifests and assign to cargo and locations
- Trigger list presentation on arrival at a location
- Authorize delivery and verify receipt with a single click from your mobile device
- Track asset or inventory with real time dashboards and digital history reports
- Enable personnel to report issues and order new supplies

Prevent theft and inventory leakage

Track inventory movements across all your locations. Send alerts when issues are detected and identify the last person in contact with high-value assets.

- Create rules related to employee access and schedule
- Send automated alerts when exceptions are triggered (e.g. unauthorized personnel)
- Enhanced security of expensive devices and theft prevention

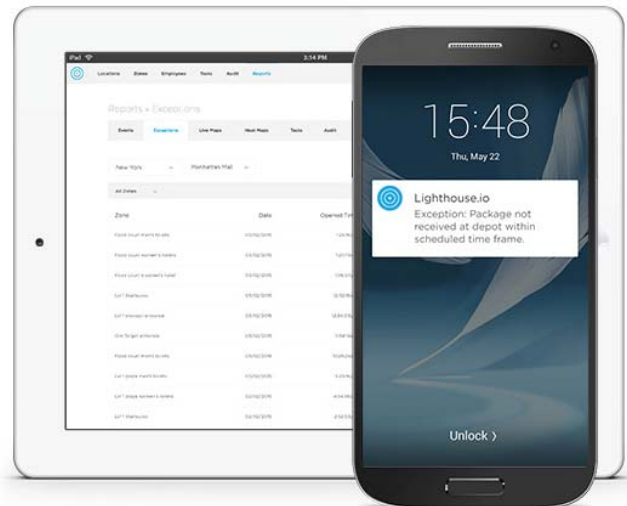

<http://lighthouse.io/logistics/>