

**IN THE UNITED STATES DISTRICT COURT
FOR THE NORTHERN DISTRICT OF ILLINOIS
EASTERN DIVISION**

**APTARGROUP, INC. and APTAR FRANCE
S.A.S.,**

Plaintiffs,

v.

**3M CO., MERCK & CO., INC., and MERCK,
SHARP & DOHME CORP.,**

Defendants.

Civil Action No. _____

Judge:

JURY TRIAL DEMANDED

ORIGINAL COMPLAINT

Plaintiffs AptarGroup, Inc. (“AptarGroup”) and Aptar France S.A.S. (“Aptar France”) (collectively, “Aptar”) file this Original Complaint against 3M Co. (“3M”), Merck & Co., Inc. (“Merck & Co.”), and Merck, Sharp & Dohme (“MSD”)¹ and allege as follows:

THE PARTIES

1. Plaintiff AptarGroup is a Delaware corporation having its principal place of business at 475 West Terra Cotta, Suite E, Crystal Lake, IL 60014. Plaintiff Aptar France is a French corporation having its principal place of business at Lieudit Le Prieuré, 27110 Le Neubourg, France. Aptar France is a subsidiary of AptarGroup. Aptar is a leading global provider of a broad range of innovative packaging, dispensing, and sealing solutions in the beauty, personal care, home care, prescription drug, consumer health care, injectables, and food and beverage markets. Among the products offered by Aptar are dose counters for metered dose

¹ Merck & Co. and MSD will be collectively referred to herein as “Merck.” 3M and Merck will be collectively referred to herein as “Defendants.”

inhalers (“MDIs”), which are designed to contribute to patient compliance and eliminate miscounting.

2. Upon information and belief, Defendant 3M is Delaware corporation having its principal place of business at 3M Center, St. Paul, MN 55144. Upon information and belief, 3M is a global science company that designs, manufactures, uses, imports into the United States, sells, and/or offers for sale in the United States dose counter products for MDIs, including the 3M™ Integrated Dose by Dose Counter. 3M’s devices are marketed, offered for sale, and/or sold throughout the United States, including within this District.

3. Upon information and belief, Defendant Merck & Co. is a New Jersey corporation having its principal place of business at 2000 Galloping Hill Rd, Kenilworth, NJ 07033. Upon information and belief, Defendant MSD is a New Jersey corporation having its principal place of business at One Merck Drive, Whitehouse Station, NJ 08889. Upon information and belief, Merck designs, manufactures, uses, imports into the United States, sells, and/or offers for sale in the United States pharmaceutical products, including the Dulera® inhaler. Dulera is marketed as inhaled medicine for controlling and preventing asthma symptoms. Merck’s products are marketed, offered for sale, and/or sold throughout the United States, including within this District.

JURISDICTION AND VENUE

4. This is an action arising under the patent laws of the United States, 35 U.S.C. § 271. This Court has exclusive subject matter jurisdiction under 28 U.S.C. §§ 1331 and/or 1338.

5. Venue is proper in this Court under 28 U.S.C. §1400(b). As described herein, 3M has committed and continues to commit acts of direct and indirect infringement within this District. 3M has a regular and established place of business in this District, including, but not

limited to, 3M's DeKalb plant, described on 3M's website as 3M's "largest distribution facility in the world."²

6. As described herein, Merck has committed and continues to commit acts of direct and indirect infringement within this District. Merck has a regular and established place of business in this District, including, but not limited to, its permanent and continuous employment of pharmaceutical sales specialists and other employees in this District. Joinder is proper under 35 U.S.C. § 299.

7. This Court has personal jurisdiction over 3M. 3M has conducted and does conduct business within the State of Illinois. 3M, directly or through subsidiaries or intermediaries (including distributors, retailers, and others), ships, distributes, offers for sale, sells, and/or advertises (including via the provision of an interactive web page) its products (including infringing products) and/or services in the United States, the State of Illinois, and the Northern District of Illinois. 3M, directly and through subsidiaries or intermediaries (including distributors, retailers, and others), has purposefully and voluntarily placed one or more of its infringing products and/or services, as described below, into the stream of commerce with the expectation that they will be purchased and used by consumers in the Northern District of Illinois. These infringing products and/or services have been and continue to be purchased and used by consumers in the Northern District of Illinois. 3M has committed acts of patent infringement within the State of Illinois and, more particularly, within the Northern District of Illinois. This Court also has personal jurisdiction over 3M by virtue of the fact that 3M maintains and operates its DeKalb plant in this District.

8. This Court has personal jurisdiction over Merck. Merck has conducted and does conduct business within the State of Illinois. Merck, directly or through subsidiaries or

² Exhibit 1 (available at http://www.3m.com/3M/en_US/plant-locations-us/dekalb/).

intermediaries (including distributors, retailers, and others), ships, distributes, offers for sale, sells, and/or advertises (including via the provision of an interactive web page) its products (including infringing products) and/or services in the United States, the State of Illinois, and the Northern District of Illinois. Merck, directly and through subsidiaries or intermediaries (including distributors, retailers, and others), has purposefully and voluntarily placed one or more of its infringing products and/or services, as described below, into the stream of commerce with the expectation that they will be purchased and used by consumers in the Northern District of Illinois. These infringing products and/or services have been and continue to be purchased and used by consumers in the Northern District of Illinois. Merck has committed acts of patent infringement within the State of Illinois and, more particularly, within the Northern District of Illinois.

THE APTAR PATENTS-IN-SUIT

9. United States Patent No. 9,370,631 (“the ’631 Patent”), entitled “Fluid Product Dispenser,” was duly and legally issued to inventor Fabien Poulard on June 21, 2016. Aptar France owns by assignment the entire right, title, and interest in the ’631 Patent. AptarGroup is the exclusive licensee of the ’631 Patent and is entitled to sue for past and future infringement.

10. United States Patent No. 8,936,177 (“the ’177 Patent”), entitled “Fluid Product Dispenser,” was duly and legally issued to inventor Fabien Poulard on January 20, 2015. Aptar France owns by assignment the entire right, title, and interest in the ’177 Patent. AptarGroup is the exclusive licensee of the ’177 Patent and is entitled to sue for past and future infringement.

11. The ’631 and ’177 Patents are collectively referred to in this Complaint as the “Patents-in-Suit.”

GENERAL ALLEGATIONS

12. Aptar is the leader in the global dispensing systems industry, with over half of a century of experience operating in the consumer packaging world. Aptar sells a broad range of award-winning and innovative packing, dispensing, and sealing products across numerous industries. Aptar's product solutions include dose counters and indicators for MDIs.

13. 3M manufactures, uses, sells, and/or markets an Integrated Dose by Dose Counter. In marketing materials describing the Integrated Dose by Dose Counter on 3M's website, available throughout the United States, including in this District, 3M states that "[r]unning out of medication is a serious concern for patients using metered-dose inhalers (MDIs)."³ "The 3M™ Integrated Dose by Dose Counter provides a patient- and manufacturer-friendly solution to guidance issued by the Food and Drug Administration (FDA) requiring dose counters to address this concern."⁴

14. In a video on its website, available throughout the United States, including in this District, 3M includes a cross-section of the Integrated Dose by Dose Counter in operation.⁵ Images from 3M's video are included below:

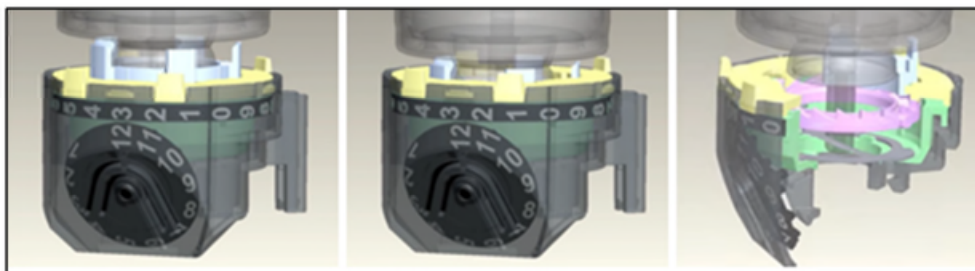

³ Exhibit 2 (available at <http://multimedia.3m.com/mws/media/684603O/dose-by-dose-counter-sell-sheet-10-2010-pdf.pdf>).

⁴ *Id.*

⁵ Exhibit 3 (available at "Inhalation Drug Delivery: Manufacturing Services from Start to Finish" video at http://www.3m.com/3M/en_US/drug-delivery-systems-us/technologies/inhalation/mdi/).

15. In additional marketing materials on 3M's website, available throughout the United States, including in this District, 3M states that dose counters should be designed to specifically avoid undercounting.⁶ 3M's website also notes that the Integrated Dose by Dose Counter "was developed to help improve compliance and to give patients a reliable and easy-to-use tool that builds their confidence in their MDI . . . The dose counter has a displacement-driven design that eliminates under-counting, while the split-count principle avoids over-counting. With a familiar look and clear display, it requires no additional training for patients, and its ergonomic design suits a wide range of users."⁷ 3M's website also states that "[f]or a displacement driven counter, it is essential that valve travel and valve geometry are matched and synchronized with the counter to avoid undercounting."⁸

16. Merck manufactures, uses, sells, and/or markets the drug Dulera, an inhaler that combines two medicines for the treatment of asthma. Dulera contains an inhaled corticosteroid, called mometasone furoate, and a long-acting beta2-agonist medicine (LABA) called formoterol fumarate dihydrate. Dulera was approved by the Food and Drug Administration on June 22, 2010.

17. Merck's Dulera inhalers incorporate the 3M Integrated Dose by Dose Counter. In marketing materials describing Dulera on Merck's website, available throughout the United States, including in this District, Merck instructs patients how to use the inhaler, stating that "DULERA has a built-in counter that shows remaining doses. With every puff the counter counts backward automatically. If you can't remember if you've taken your daily doses, check the

⁶ *Id.*

⁷ Exhibit 4 (available at <http://multimedia.3m.com/mws/media/1159486O/ondrugdelivery-pulmonary-nasal-delivery-nov-2013.pdf>).

⁸ Exhibit 5 (available at <http://multimedia.3m.com/mws/media/1159495O/statistical-tolerance-analysis-tools-in-dose-counters.pdf>).

counter.”⁹ In a video instructing patients how to use Dulera on Merck’s website, available throughout the United States, including in this District, Merck displays the dose counter, stating that the dose counter “shows you how many actuations, puffs, are left after each use.”¹⁰ An image from Merck’s dose counter video illustrating how to use Dulera is shown below:



18. 3M has and continues to directly and indirectly infringe the Patents-in-Suit by engaging in acts constituting infringement under 35 U.S.C. § 271(a), (b), (c), and/or (f), including but not limited to one or more of making, using, selling, and offering to sell, in this District and elsewhere in the United States, and importing into this District and elsewhere in the United States, fluid dispensing products incorporating the Integrated Dose-by-Dose Counter (“3M Infringing Products”). Acts constituting active inducement and contributory infringement described herein have also been performed in this District and elsewhere in the United States.

19. 3M is doing business in the United States and, more particularly, in the Northern District of Illinois by making, using, selling, importing, and/or offering for sale 3M Infringing

⁹ Exhibit 6 (available at http://www.dulera.com/mometasone_formoterol/dulera/consumer/using_your_dulera_inhaler.jsp).

¹⁰ *Id.*

Products that infringe the patent claims involved in this action or by transacting other business in this District.

20. Merck has and continues to directly and indirectly infringe the Patents-in-Suit by engaging in acts constituting infringement under 35 U.S.C. § 271(a), (b), (c), and/or (f), including but not limited to one or more of making, using, selling, and offering to sell, in this District and elsewhere in the United States, and importing into this District and elsewhere in the United States, fluid dispensing products, such as the Dulera inhaler, which incorporate the Integrated Dose-by-Dose Counter (“Merck Infringing Products”). Acts constituting active inducement infringement described herein have also been performed in this District and elsewhere in the United States.

21. Merck is doing business in the United States and, more particularly, in the Northern District of Illinois by making, using, selling, importing, and/or offering for sale Merck Infringing Products that infringe the patent claims involved in this action or by transacting other business in this District.

COUNT I:
3M’S INFRINGEMENT OF U.S. PATENT NO. 9,370,631

22. Aptar repeats and realleges the allegations in paragraphs 1-21 as if fully set forth herein. As described below, 3M has infringed and/or continues to infringe the ’631 Patent.

23. The 3M Infringing Products infringe claims 1-4 of the ’631 Patent. 3M makes, uses, sells, offers for sale, imports, exports, supplies, and/or distributes within the United States these products and thus directly infringes claims 1-4 of the ’631 Patent.

24. The 3M Infringing Products practice each limitation of claim 1 of the ’631 Patent. The 3M Infringing Products include a plurality of displayable dose values. For example, as

shown in the image below, the 3M Infringing Products include black dials that include numbered dose values that are displayed through the window of the blue plastic housing.



25. The 3M Infringing Products include a stationary body comprising at least one stationary multi-toothed gear. For example, as shown in the images below, the 3M Infringing Products include a blue plastic housing and a white plastic disc with a gear containing multiple teeth. This disc is the “lid” of the clear plastic cup that holds the numbered dials, and either the disc or the disc and the housing are stationary with respect to the reservoir.

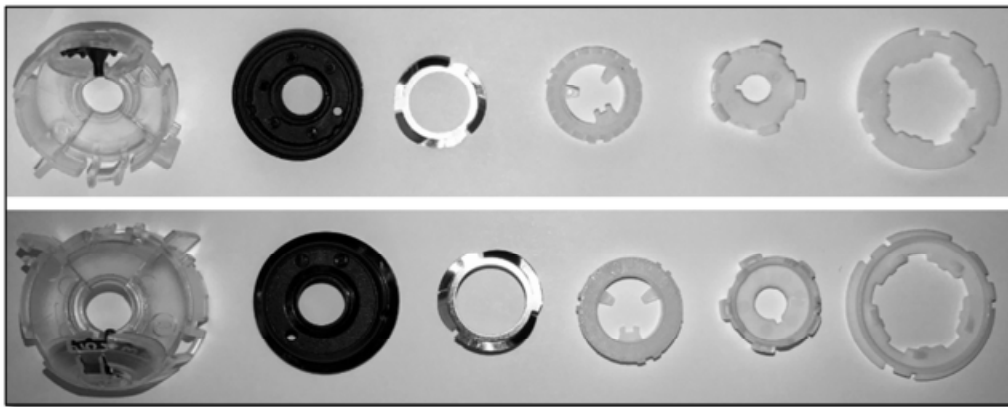

26. The 3M Infringing Products include a first member that is displaceable axially relative to said stationary body. For example, as shown in the images below, the 3M Infringing Products include a castellated white plastic piece that moves axially relative to either the white lid or the lid and the housing.

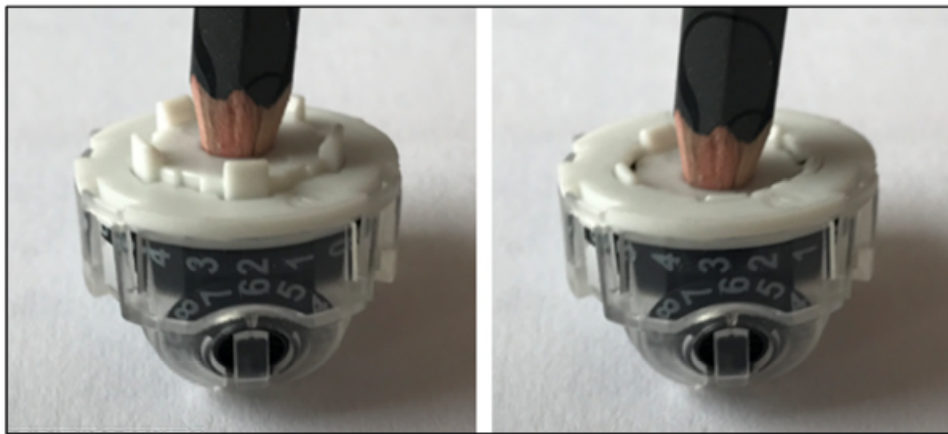

27. The 3M Infringing Products include a second member that is displaceable axially and in rotation relative to said stationary body, said second member being engageable with said first member and said stationary body. For example, as shown in the images below, the 3M Infringing Products include a saw-toothed ring that is positioned under the lid and the castellated piece. The ring engages with the lid via an outer row of teeth and with the castellated piece via an inner row of teeth. As shown in the images below, when the castellated piece moves axially downward, the ring also moves axially downward and rotates relative to either the lid or the lid and the housing.¹¹

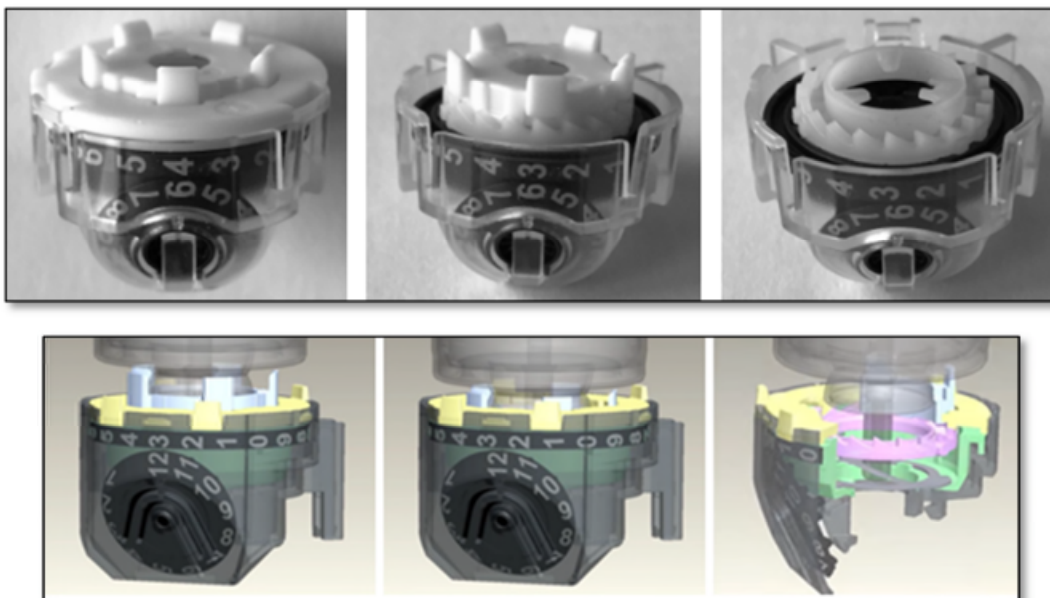

28. The 3M Infringing Products also include a first member such that when said first member displaces axially, the stationary body is configured to allow a fluid reservoir to be axially displaceable relative to said stationary body and said second member is caused to be displaced axially and permitted to rotate relative to said stationary body, so as to change a displayed dose value from among the plurality of displayable dose values. For example, a drug

¹¹ Exhibit 3 (available at “Inhalation Drug Delivery: Manufacturing Services from Start to Finish” video at http://www.3m.com/3M/en_US/drug-delivery-systems-us/technologies/inhalation/mdi/).

canister sits on top of the castellated piece. As shown in the images below, the drug canister and castellated piece are displaced axially downward relative to either the lid or the lid and the housing. The downward axial movement of the castellated piece also causes the downward axial movement of the saw-toothed ring, which releases the ring from engagement with the lid, permitting the ring to rotate relative to either the lid or the lid and the housing. As shown in the images below, the rotation of the ring causes the black plastic dial to rotate, changing the displayed dose value.¹²

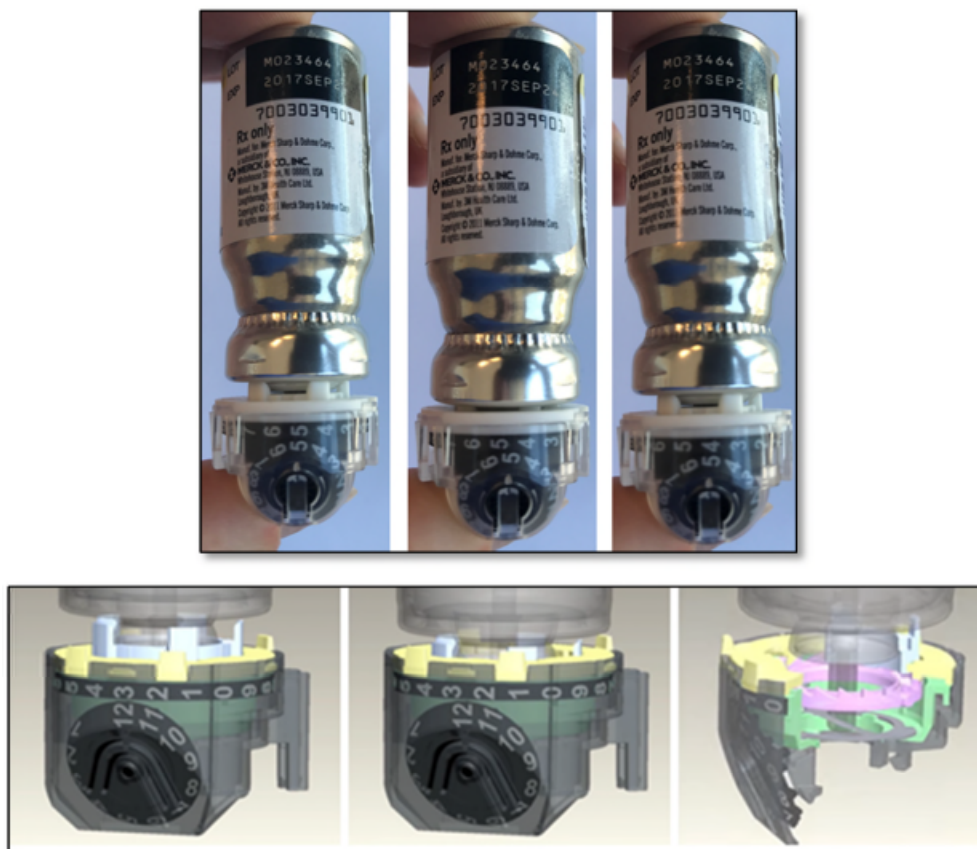

29. The 3M Infringing Products include a stationary body, first member, and second member that are arranged to have a common central longitudinal axis, and the first member is

¹² Exhibit 3 (available at “Inhalation Drug Delivery: Manufacturing Services from Start to Finish” video at http://www.3m.com/3M/en_US/drug-delivery-systems-us/technologies/inhalation/mdi/).

displaceable axially along the central longitudinal axis, and the second member is displaceable axially along¹³ the central longitudinal axis and is displaceable rotationally around the central longitudinal axis. For example, as shown in the image below, the lid, castellated piece, and ring are stacked together in the blue housing and share a common central axis. As described above, the castellated piece moves axially, and the ring moves axially and rotationally, both along a common longitudinal axis.¹⁴

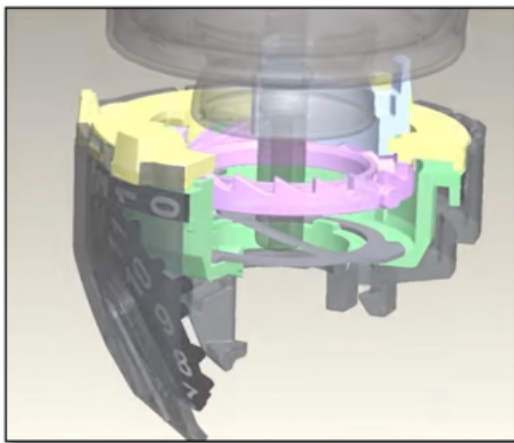

30. The 3M Infringing Products practice each limitation of claim 2 of the '631 Patent. The 3M Infringing Products include a fluid dispenser wherein the second member comprises at least one multi-toothed gear. For example, as shown in the images below, the 3M Infringing Products include a saw-toothed ring with at least one gear containing multiple teeth.

¹³ The patent as issued contains a typographical error, stating that the “second member is displaceable alo the central longitudinal axis . . .” However, it is evident from the face of the patent that the patentee intended the claim to read “second member is displaceable along the central longitudinal axis . . .”

¹⁴ See Exhibit 3 (available at “Inhalation Drug Delivery: Manufacturing Services from Start to Finish,” http://www.3m.com/3M/en_US/drug-delivery-systems-us/technologies/inhalation/mdi/).

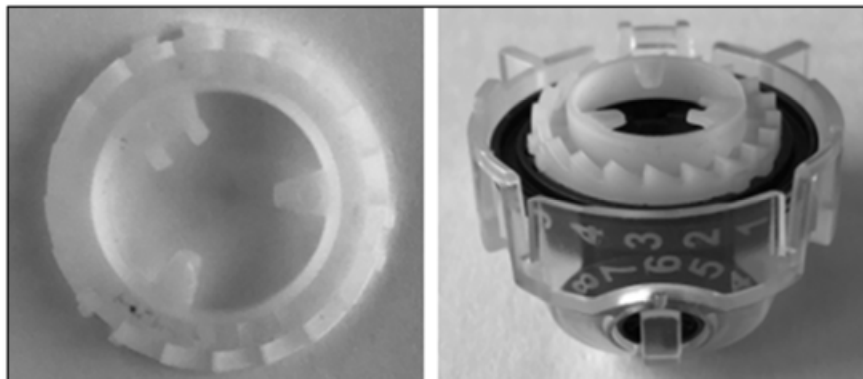

31. The 3M Infringing Products practice each limitation of claim 3 of the '631 Patent. The 3M Infringing Products include a plurality of displayable dose values. For example, and as stated above in ¶ 24, the 3M Infringing Products include black dials that include numbered dose values that are displayed through the window of the blue plastic housing.

32. The 3M Infringing Products include a stationary body comprising at least one stationary multi-toothed gear. For example, and as stated above in ¶ 25, the 3M Infringing Products include a blue plastic housing and a white plastic disc with a gear containing multiple teeth. This disc is the lid of the clear plastic cup that holds the numbered dials, and either the disc or the disc and the housing are stationary with respect to the reservoir.

33. The 3M Infringing Products include a fluid reservoir disposed on said stationary body so as to be axially displaceable relative to said stationary body. For example, as shown in the images below, the 3M Infringing Products include a drug canister that sits on top of the lid. The drug canister moves axially relative to either the lid or the housing or both.



34. The 3M Infringing Products include a first member that is displaceable axially relative to said stationary body. For example, and as stated above in ¶ 26, the 3M Infringing Products include a castellated white plastic piece that moves axially relative to either the lid or the lid and the housing.

35. The 3M Infringing Products include a second member that is displaceable axially and in rotation relative to said stationary body, said second member being engageable with said first member and said stationary body. For example, and as stated above in ¶ 27, the 3M Infringing Products include a saw-toothed ring that is positioned under the lid and the castellated piece. The ring engages with the lid via an outer row of teeth and with the castellated piece via an inner row of teeth. When the castellated piece moves axially downward, the ring also moves axially downward and rotates relative to either the lid or the lid and the housing.

36. The 3M Infringing Products include a first member such that when said first member displaces axially, said second member is caused to be displaced axially and permitted to rotate relative to said stationary body, so as to change a displayed dose value from among the plurality of displayable dose values. For example, and as stated above in ¶ 28, a drug canister sits

on top of the castellated piece. The drug canister and castellated piece are displaced axially downward relative to either the lid or the lid and the housing. The downward axial movement of the castellated piece also causes the downward axial movement of the saw-toothed ring, which releases the ring from engagement with the lid, permitting the ring to rotate relative to either the lid or the lid and the housing. The rotation of the ring causes the black plastic dial to rotate, changing the displayed dose value.

37. The 3M Infringing Products include a stationary body, first member, and second member that are arranged to have a common central longitudinal axis, and the first member is displaceable axially along the central longitudinal axis, and the second member is displaceable along the central longitudinal axis and is displaceable rotationally around the central longitudinal axis. For example, and as stated above in ¶ 29, the lid, castellated piece, and ring are stacked together in the blue housing and share a common central axis. As described above, the castellated piece moves axially, and the ring moves axially and rotationally, both along a common longitudinal axis.

38. The 3M Infringing Products practice each limitation of claim 4 of the '631 Patent. The 3M Infringing Products include a fluid reservoir wherein the fluid reservoir is configured to be axially displaced relative to said stationary body during actuation of the fluid dispenser. For example, a drug canister sits on top of the lid. As shown in the images below, the drug canister moves axially during actuation relative to either the lid or the lid and the housing.



39. 3M indirectly infringes the '631 Patent by inducing infringement by others, such as manufacturers, distributors, resellers, and/or end users, of claims 1-4 in accordance with 35 U.S.C. § 271(b) in this District and elsewhere in the United States. Merck is such a manufacturer, distributor, reseller, and/or end user. Direct infringement is the result of activities performed by the manufacturers, distributors, resellers, and/or end users of the 3M Infringing Products. For example, Merck directly infringes the '631 Patent as explained below in Count II. 3M had actual notice of the '631 Patent on or before the date that 3M was served with this Complaint.

40. 3M's affirmative acts of selling 3M Infringing Products, causing the 3M Infringing Products to be manufactured and distributed, maintaining its website, and/or providing instruction manuals and marketing materials for 3M Infringing Products have encouraged, aided, instructed, and/or caused others, including Merck, to make, use, sell, or offer to sell 3M Infringing Products in their normal and customary way to infringe the '631 Patent. 3M has specifically intended its manufacturers, resellers, distributors, and/or end users to infringe the '631 Patent; further, at least as of the date the Complaint was served, 3M has been aware that

these normal and customary activities would infringe the '631 Patent. 3M has performed the acts that constitute induced infringement, and would induce actual infringement, with knowledge of the '631 Patent and with the knowledge or willful blindness that the induced acts would constitute infringement. 3M's acts constitute induced infringement and it is therefore liable as an infringer. The acts constituting inducement have occurred throughout the United States and in this District.

41. A reasonable inference to be drawn from the facts set forth is that the 3M Infringing Products are especially made or especially adapted to operate in an infringing manner as described above in paragraphs 23 to 38.

42. A reasonable inference to be drawn from the facts set forth is that the 3M Infringing Products are not staple articles or commodities of commerce, and that the use of the 3M Infringing Products is required for operation. Any other use would be unusual, far-fetched, illusory, impractical, occasional, aberrant, or experimental.

43. The 3M Infringing Products are each a material part of the invention of the '631 Patent and are especially made for the infringing manufacture, sale, and use of 3M Infringing Products as described above in paragraphs 23 to 38. Because the sales, offers for sale, use, and manufacture of 3M Infringing Products infringe the '631 Patent, 3M's sales of the 3M Infringing Products have no substantial non-infringing uses.

44. In particular, 3M has offered to sell, or sold, or imported the 3M Infringing Products, which constitute a material part of the invention of the '631 Patent, knowing the same to be especially made or especially adapted for use in an infringement of the '631 Patent, and knowing that the same are not staple articles or commodities of commerce suitable for substantial non-infringing use.

45. 3M received actual notice of its infringement of the '631 Patent through at least the service of this Complaint.

46. Thus, a reasonable inference to be drawn is that 3M further indirectly infringes the '631 Patent by contributing to the infringement by others, such as end users, and 3M has contributed to and/or continues to contribute to infringement of at least claims 1-4 of the '631 Patent, pursuant to 35 U.S.C. § 271(c), by virtue of its offer to sell, or sale, or import into the United States a component of a patented machine, manufacture, combination, or composition, or a material or apparatus for use in practicing a patented process, which are not staple articles or commodities of commerce and which have no substantial non-infringing use. The acts constituting contributory infringement have occurred throughout the United States and in this District.

47. 3M's acts of infringement have caused damage to Aptar. Aptar is entitled to recover from 3M the damages sustained by Aptar as a result of 3M's wrongful acts in an amount subject to proof at trial.

COUNT II:
MERCK'S INFRINGEMENT OF U.S. PATENT NO. 9,370,631

48. Aptar repeats and realleges the allegations in paragraphs 1-47 as if fully set forth herein. As described below, Merck has infringed and/or continues to infringe the '631 Patent.

49. The Merck Infringing Products infringe claims 1-4 of the '631 Patent. Merck makes, uses, sells, offers for sale, imports, exports, supplies, and/or distributes within the United States these products and thus directly infringes claims 1-4 of the '631 Patent.

50. The Merck Infringing Products practice each limitation of claim 1 of the '631 Patent. The Merck Infringing Products include a plurality of displayable dose values. For

example, as shown in the image below, the Merck Infringing Products include black dials that include numbered dose values that are displayed through the window of the blue plastic housing.

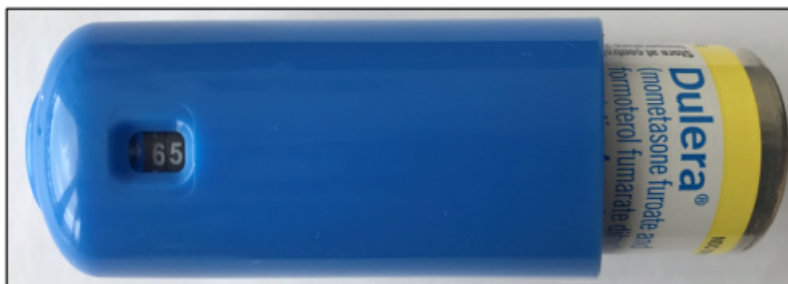

51. The Merck Infringing Products include a stationary body comprising at least one stationary multi-toothed gear. For example, as shown in the images below, the Merck Infringing Products include a blue plastic housing and a white plastic disc with a gear containing multiple teeth. This disc is the “lid” of the clear plastic cup that holds the numbered dials, and either the disc or the disc and the housing are stationary with respect to the reservoir.



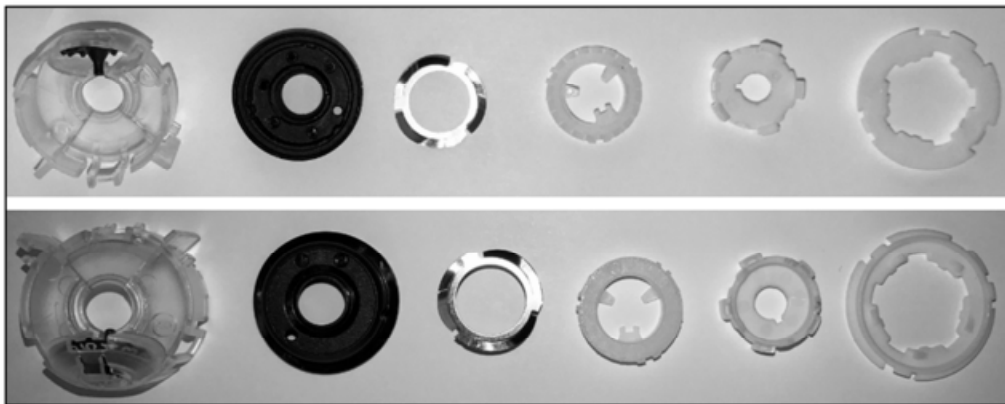

52. The Merck Infringing Products include a first member that is displaceable axially relative to said stationary body. For example, as shown in the images below, the Merck Infringing Products include a castellated white plastic piece that moves axially relative to either the white lid or the lid and the housing.

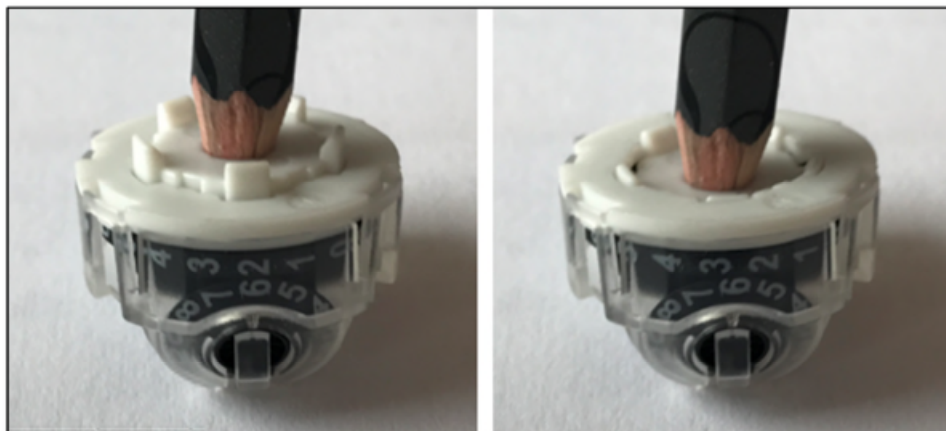

53. The Merck Infringing Products include a second member that is displaceable axially and in rotation relative to said stationary body, said second member being engageable with said first member and said stationary body. For example, as shown in the images below, the Merck Infringing Products include a saw-toothed ring that is positioned under the lid and the castellated piece. The ring engages with the lid via an outer row of teeth and with the castellated piece via an inner row of teeth. As shown in the images below, when the castellated piece moves

axially downward, the ring also moves axially downward and rotates relative to either the lid or the lid and the housing.¹⁵

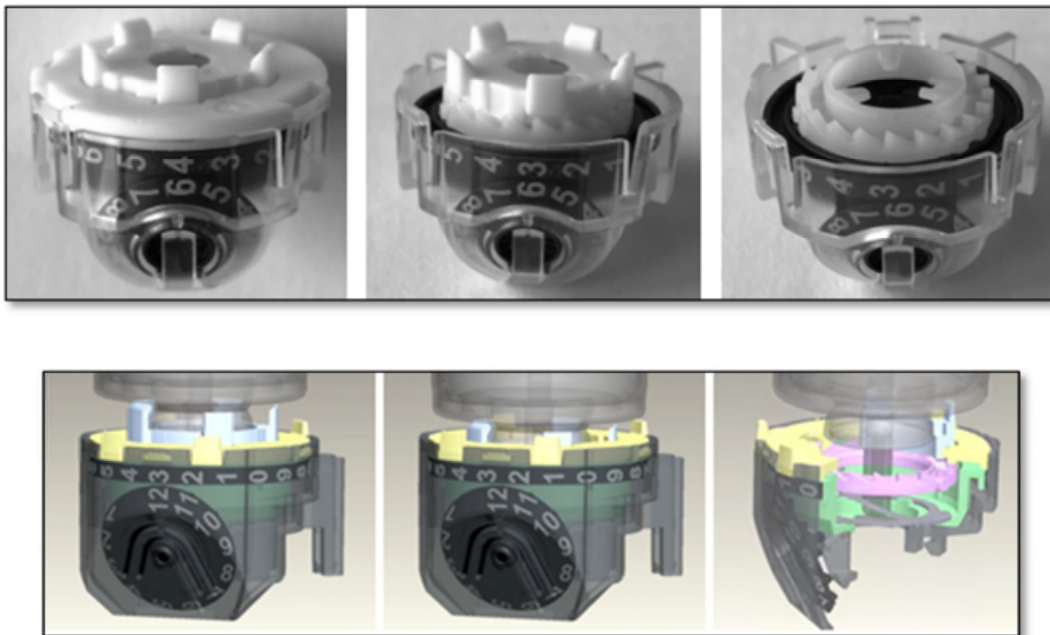

54. The Merck Infringing Products also include a first member such that when said first member displaces axially, the stationary body is configured to allow a fluid reservoir to be axially displaceable relative to said stationary body and said second member is caused to be displaced axially and permitted to rotate relative to said stationary body, so as to change a displayed dose value from among the plurality of displayable dose values. For example, as shown in the images below, a drug canister sits on top of the castellated piece. The drug canister and castellated piece are displaced axially downward relative to either the lid or the lid and the blue housing. The downward axial movement of the castellated piece also causes the downward axial movement of the saw-toothed ring, which releases the ring from engagement with the lid, permitting the ring to rotate relative to either the lid or the lid and the housing. As shown in the

¹⁵ Exhibit 3 (available at “Inhalation Drug Delivery: Manufacturing Services from Start to Finish” video at http://www.3m.com/3M/en_US/drug-delivery-systems-us/technologies/inhalation/mdi/).

images below, the rotation of the ring causes the black plastic dial to rotate, changing the displayed dose value.¹⁶

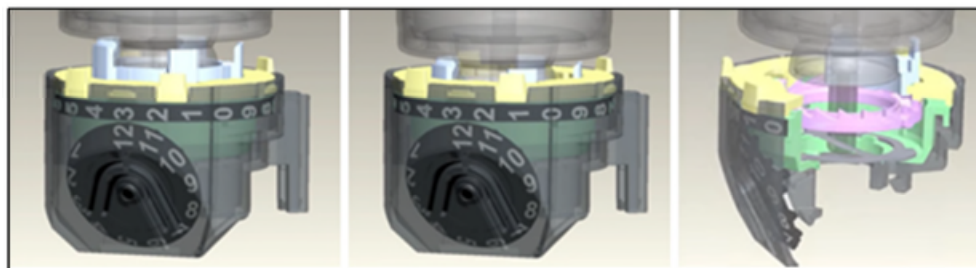

55. The Merck Infringing Products include a stationary body, first member, and second member that are arranged to have a common central longitudinal axis, and the first member is displaceable axially along the central longitudinal axis, and the second member is displaceable axially along¹⁷ the central longitudinal axis and is displaceable rotationally around the central longitudinal axis. For example, as shown in the image below, the lid, castellated

¹⁶ Exhibit 3 (available at “Inhalation Drug Delivery: Manufacturing Services from Start to Finish” video at http://www.3m.com/3M/en_US/drug-delivery-systems-us/technologies/inhalation/mdi/).

¹⁷ The patent as issued contains a typographical error, stating that the “second member is displaceable aloe the central longitudinal axis . . .” However, it is evident from the face of the patent that the patentee intended the claim to read “second member is displaceable along the central longitudinal axis . . .”

piece, and ring are stacked together in the blue housing and share a common central axis. As described above, the castellated piece moves axially, and the ring moves axially and rotationally, both along a common longitudinal axis.¹⁸

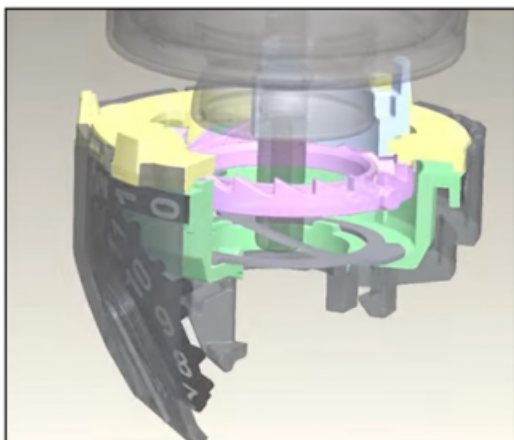

56. The Merck Infringing Products practice each limitation of claim 2 of the '631 Patent. The Merck Infringing Products include a fluid dispenser wherein the second member comprises at least one multi-toothed gear. For example, as shown in the images below, the Merck Infringing Products include a saw-toothed ring with at least one gear containing multiple teeth.

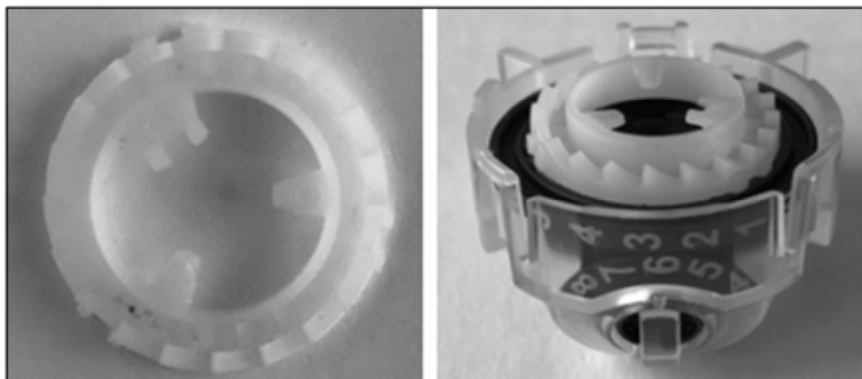

¹⁸ See Exhibit 3 (available at "Inhalation Drug Delivery: Manufacturing Services from Start to Finish," http://www.3m.com/3M/en_US/drug-delivery-systems-us/technologies/inhalation/mdi/).

57. The Merck Infringing Products practice each limitation of claim 3 of the '631 Patent. The Merck Infringing Products include a plurality of displayable dose values. For example, and as stated above in ¶ 50, the Merck Infringing Products include black dials that include numbered dose values that are displayed through the window of the blue plastic housing.

58. The Merck Infringing Products include a stationary body comprising at least one stationary multi-toothed gear. For example, and as stated above in ¶ 51, the Merck Infringing Products include a blue plastic housing and a white plastic disc with a gear containing multiple teeth. This disc is the lid of the clear plastic cup that holds the numbered dials, and either the disc or the disc and the housing are stationary with respect to the reservoir.

59. The Merck Infringing Products include a fluid reservoir disposed on said stationary body so as to be axially displaceable relative to said stationary body. For example, as shown in the images below, the Merck Infringing Products include a drug canister that sits on top of the lid. The drug canister moves axially relative to either the lid or the lid and the housing.



60. The Merck Infringing Products include a first member that is displaceable axially relative to said stationary body. For example, and as stated above in ¶ 52, the Merck Infringing

Products include a castellated white plastic piece that moves axially relative to either the lid or the lid and the housing.

61. The Merck Infringing Products include a second member that is displaceable axially and in rotation relative to said stationary body, said second member being engageable with said first member and said stationary body. For example, and as stated above in ¶ 53, the Merck Infringing Products include a saw-toothed ring that is positioned under the lid and the castellated piece. The ring engages with the lid via an outer row of teeth and with the castellated piece via an inner row of teeth. When the castellated piece moves axially downward, the ring also moves axially downward and rotates relative to either the lid or the lid and the housing.

62. The Merck Infringing Products include a first member such that when said first member displaces axially, said second member is caused to be displaced axially and permitted to rotate relative to said stationary body, so as to change a displayed dose value from among the plurality of displayable dose values. For example, and as stated above in ¶ 54, a drug canister sits on top of the castellated piece. The drug canister and castellated piece are displaced axially downward relative to either the lid or the lid and the housing. The downward axial movement of the castellated piece also causes the downward axial movement of the saw-toothed ring, which releases the ring from engagement with the lid, permitting the ring to rotate relative to either the lid or the lid and the housing. The rotation of the ring causes the black plastic dial to rotate, changing the displayed dose value.

63. The Merck Infringing Products include a stationary body, first member, and second member that are arranged to have a common central longitudinal axis, and the first member is displaceable axially along the central longitudinal axis, and the second member is displaceable along the central longitudinal axis and is displaceable rotationally around the central

longitudinal axis. For example, and as stated above in ¶ 55, the lid, castellated piece, and ring are stacked together in the blue housing and share a common central axis. As described above, the castellated piece moves axially, and the ring moves axially and rotationally, both along a common longitudinal axis.

64. The Merck Infringing Products practice each limitation of claim 4 of the '631 Patent. The Merck Infringing Products include a fluid reservoir wherein the fluid reservoir is configured to be axially displaced relative to said stationary body during actuation of the fluid dispenser. For example, a drug canister sits on top of the lid. As shown in the images below, the drug canister moves axially during actuation relative to either the lid or the lid and the housing.



65. Merck indirectly infringes the '631 Patent by inducing infringement by others, such as manufacturers, distributors, resellers, and/or end users, of claims 1-4 in accordance with 35 U.S.C. § 271(b) in this District and elsewhere in the United States. 3M is such a manufacturer, distributor, reseller, and/or end user. Direct infringement is the result of activities performed by the manufacturers, distributors, resellers, and/or end users of the Merck Infringing Products. For example, 3M directly infringes the '631 Patent as explained above in Count I.

Merck had actual notice of the '631 Patent on or before the date that Merck was served with this Complaint.

66. Merck's affirmative acts of selling Merck Infringing Products, causing the Merck Infringing Products to be manufactured and distributed, employing pharmaceutical sales specialists, maintaining its website, and/or providing instruction manuals, marketing materials, coupons, a doctor portal for samples, and label/package inserts for Merck Infringing Products have encouraged, aided, instructed, and/or caused others, including 3M, to make, use, sell, or offer to sell Merck Infringing Products in their normal and customary way to infringe the '631 Patent. Merck has specifically intended its manufacturers, resellers, distributors, and/or end users to infringe the '631 Patent; further, at least as of the date the Complaint was served, Merck has been aware that these normal and customary activities would infringe the '631 Patent. Merck has performed the acts that constitute induced infringement, and would induce actual infringement, with knowledge of the '631 Patent and with the knowledge or willful blindness that the induced acts would constitute infringement. Merck's acts constitute induced infringement and it is therefore liable as an infringer. The acts constituting inducement have occurred throughout the United States and in this District.

67. Merck's acts of infringement have caused damage to Aptar. Aptar is entitled to recover from Merck the damages sustained by Aptar as a result of Merck's wrongful acts in an amount subject to proof at trial.

68. Merck received actual notice of its infringement of the '631 Patent through at least the service of this Complaint.

COUNT III.
3M'S INFRINGEMENT OF U.S. PATENT NO. 8,936,177

69. Aptar repeats and realleges the allegations in paragraphs 1-68 as if fully set forth herein. As described below, 3M has infringed and/or continues to infringe the '177 Patent.

70. The 3M Infringing Products infringe at least claims 1-3, 9, and 21 of the '177 Patent. 3M makes, uses, sells, offers for sale, imports, exports, supplies, and/or distributes within the United States these products and thus directly infringes at least claims 1-3, 9, and 21 of the '177 Patent.

71. The 3M Infringing Products practice each limitation of claim 1 of the '177 Patent. The 3M Infringing Products include a stationary body including at least one stationary gear. For example, as shown in the images below, the 3M Infringing Products include a blue plastic housing and a white plastic disc with at least one stationary gear. This disc is the "lid" of the clear plastic cup that holds the numbered dials, and either the disc or the disc and the housing are stationary with respect to the reservoir.



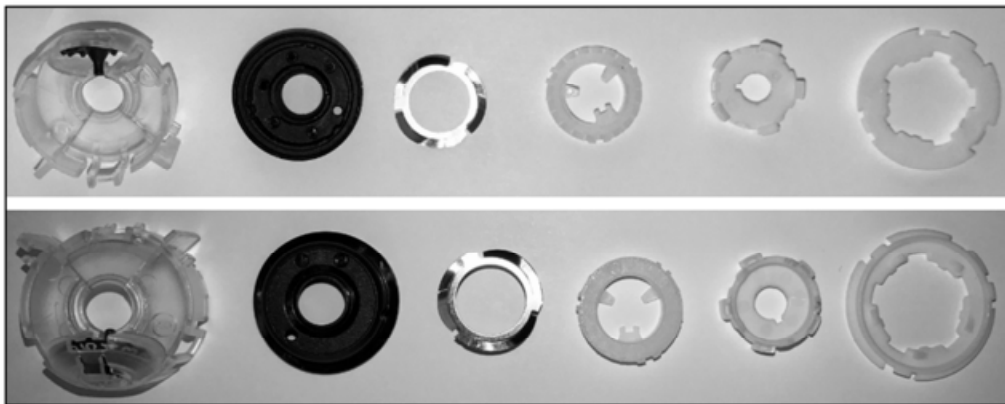

72. The 3M Infringing Products include a fluid reservoir disposed in said body so as to be axially displaceable relative to said body. For example, the 3M Infringing Products include a drug canister that sits within the blue housing and inside the outer circumference of the lid. As shown in the images below, when the drug canister is pressed down, it moves axially relative to either the lid or the lid and the housing.



73. The 3M Infringing Products include a dispenser member mounted on said reservoir. For example, as shown in the image below, the 3M Infringing Products include a valve attached to the drug canister for purposes of dispensing the medication.



74. The 3M Infringing Products include a dose indicator device, including a counter element that is displaceable axially and in rotation relative to said body. The dose indicator device indicates the number of doses of fluid that have been dispensed or that remain to be dispensed from said reservoir. For example, as shown in the images below, the 3M Infringing Products include black dials that include numbered dose values and a saw-toothed ring. The ring is positioned under the lid and the castellated piece. When the ring moves axially downward relative to either the lid or the lid and the housing, the ring also rotates relative to either the lid or the lid and the housing. As shown in the images below, the black dials include numbered values corresponding to the number of doses of medication that have been dispensed or remain to be dispensed from the drug canister.

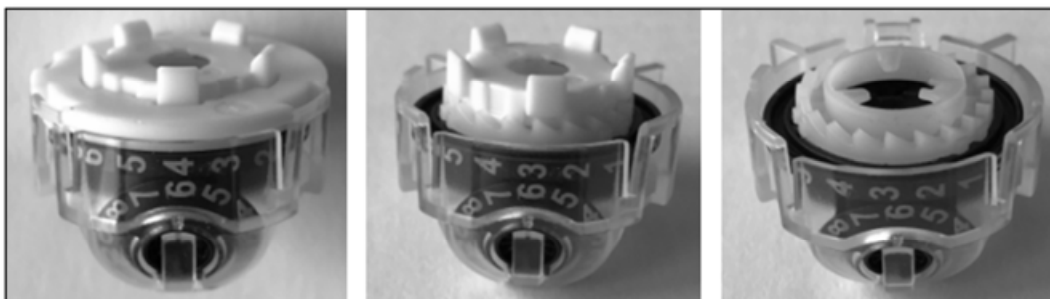

75. The 3M Infringing Products include a counter element that cooperates, while the dispenser is being actuated, firstly with said at least one stationary gear of said body, and secondly with said reservoir, so that the dose indicator device is actuated once the dispenser has performed a predetermined incomplete actuation stroke, even if the dispenser does not perform a complete actuation stroke. For example, as shown in the images below, while the 3M Infringing Products are actuated, the saw-toothed ring cooperates with the stationary gear of the lid and drug canister. When the drug canister is pressed down far enough that the ring rotates—even if the canister is not pressed down further to complete the stroke—the black dials change the displayed dose value.¹⁹

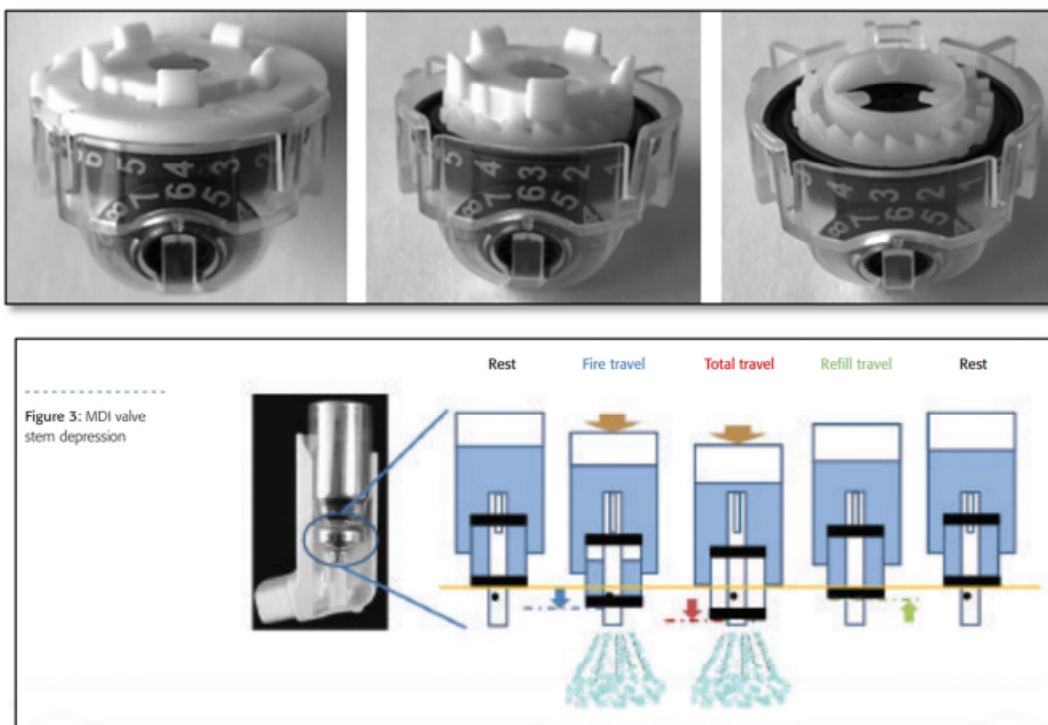

¹⁹ See Exhibit 7 (available at <http://multimedia.3m.com/mws/media/1159479O/ipt-inhalation-dc-article-sep-issue.pdf>); See Exhibit 5 (available at <http://multimedia.3m.com/mws/media/1159495O/statistical-tolerance-analysis-tools-in-dose-counters.pdf>).

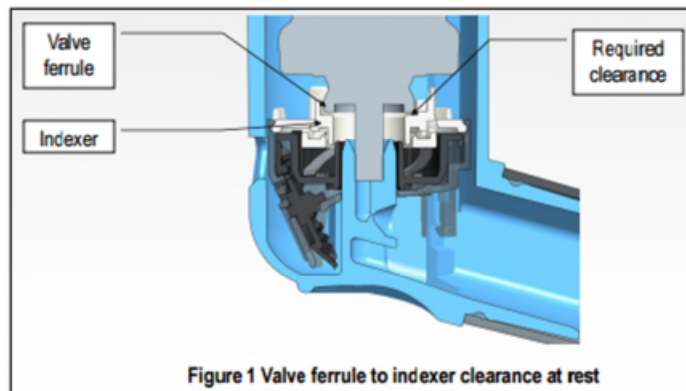

76. The 3M Infringing Products practice each limitation of claim 2 of the '177 Patent. The 3M Infringing Products include a fluid dispenser wherein, during the return stroke of the dispenser after dispensing a dose, said dose indicator device prevents the fluid from being expelled again until said dispenser has completed a predetermined incomplete return stroke, said dispenser and said dose indicator device being capable of being actuated once again, once the predetermined incomplete return stroke has been performed, even if the dispenser does not perform the complete return stroke and said dispenser is actuated once again before returning to its rest position. For example, as shown in the image below, after the a dose of medication has been dispensed and while the drug canister is performing a “refill travel” action upward to its rest position, no further medication may be expelled until the canister has traveled a certain vertical distance. This vertical distance is less than or equal to the distance required to perform the complete return stroke.²⁰

²⁰ See Exhibit 7 (available at <http://multimedia.3m.com/mws/media/11594790/ipt-inhalation-dc-article-sep-issue.pdf>).

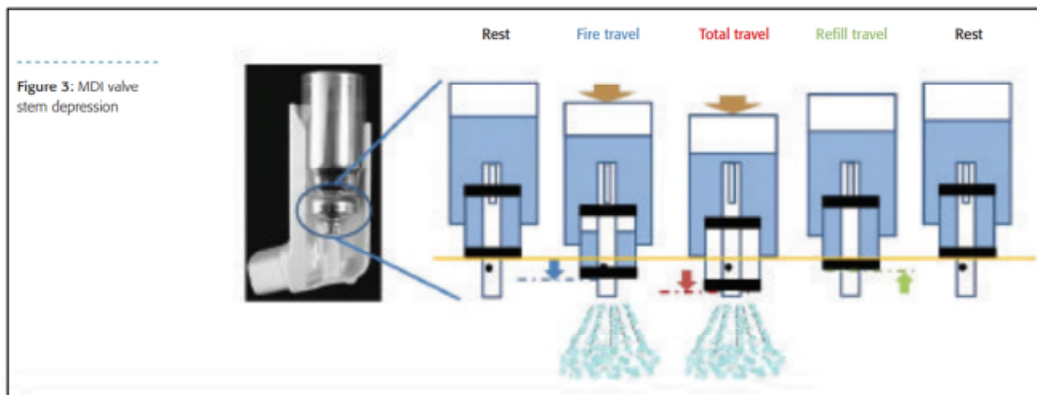

77. The 3M Infringing Products practice each limitation of claim 3 of the '177 Patent. The 3M Infringing Products include a stationary body in which said body includes a stationary gear co-operating with a first gear of said counter element. For example, as shown in the image below, the lid includes a stationary gear that cooperates with the outer ring of teeth of the saw-toothed ring.

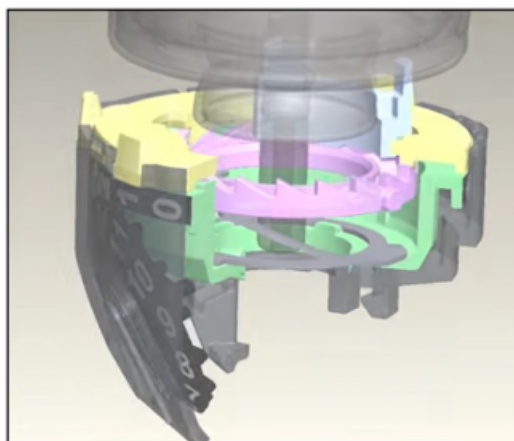

78. The 3M Infringing Products include a counter element in which said counter element includes a second gear co-operating with an actuator gear of an actuator member of the dispenser. For example, as shown in the image below the saw-toothed ring includes an inner ring of teeth that cooperate with a gear included on the castellated piece.

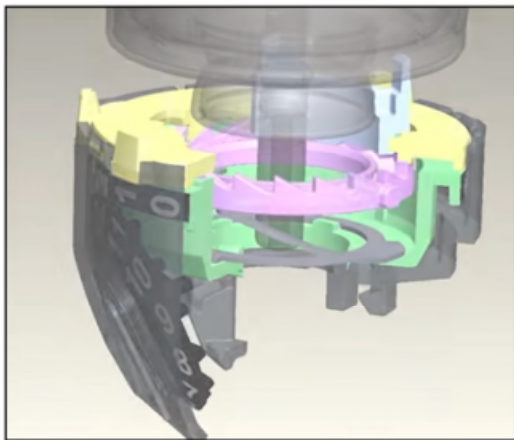

79. The 3M Infringing Products include a second gear in which the teeth of said second gear and/or of said actuator gear are made so that axial displacement of the actuator member causes said counter element to be displaced axially and in rotation. For example, as shown in the images below, the inner ring of teeth on the saw-toothed ring cooperate with the castellated piece, and when the castellated piece moves axially downward, the ring also moves axially downward and rotates.²¹

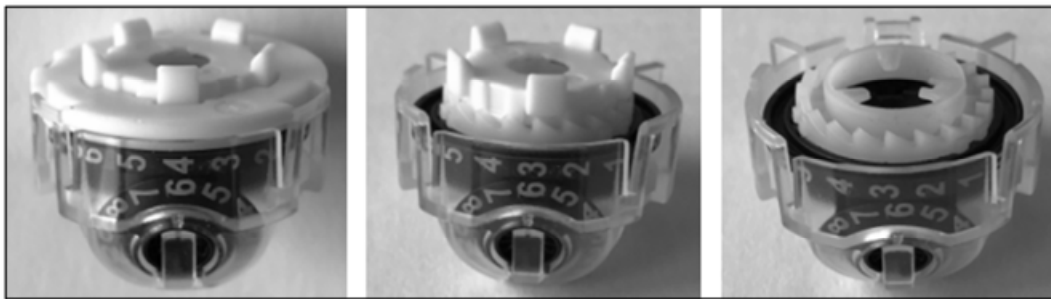

²¹ Exhibit 3 (available at “Inhalation Drug Delivery: Manufacturing Services from Start to Finish” video at http://www.3m.com/3M/en_US/drug-delivery-systems-us/technologies/inhalation/mdi/).

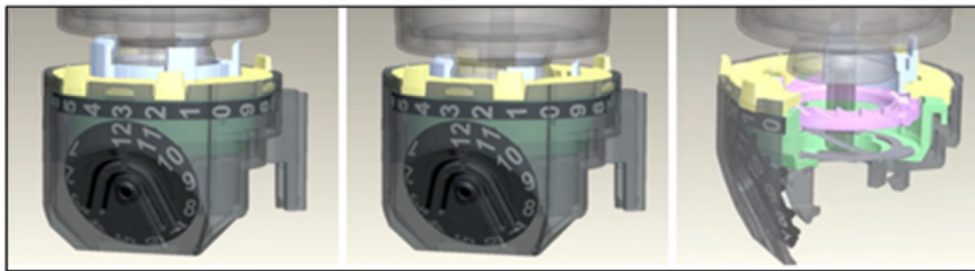

80. The 3M Infringing Products include a stationary gear in which the stationary gear prevents said counter element from turning until said counter element no longer co-operates with said stationary gear, after a predetermined axial displacement of said counter element corresponding to said predetermined incomplete actuation stroke of the dispenser. For example, as shown in the images below, the lid includes a stationary gear that prevents the saw-toothed ring from turning until the ring no longer co-operates with the lid. When the ring is at a rest position, such cooperation prevents the ring from rotating. As shown in the images below, when the ring moves axially downward and no longer cooperates with the lid, the ring turns. The axial distance required to cause the ring to turn is less than the distance of a complete actuation stroke.²²

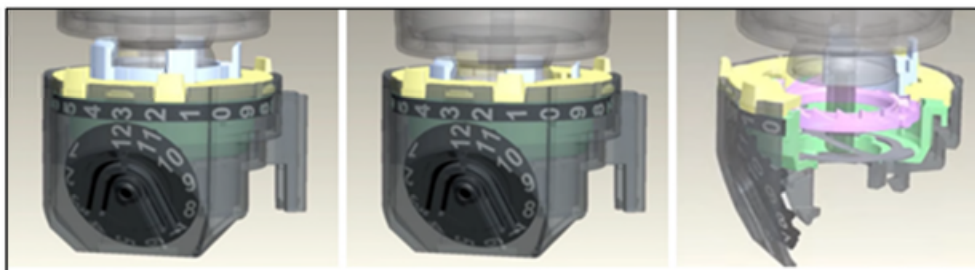

²² See Exhibit 7 (available at <http://multimedia.3m.com/mws/media/11594790/ipt-inhalation-dc-article-sep-issue.pdf>); Exhibit 3 (available at “Inhalation Drug Delivery: Manufacturing Services from Start to Finish” video at http://www.3m.com/3M/en_US/drug-delivery-systems-us/technologies/inhalation/mdi/).

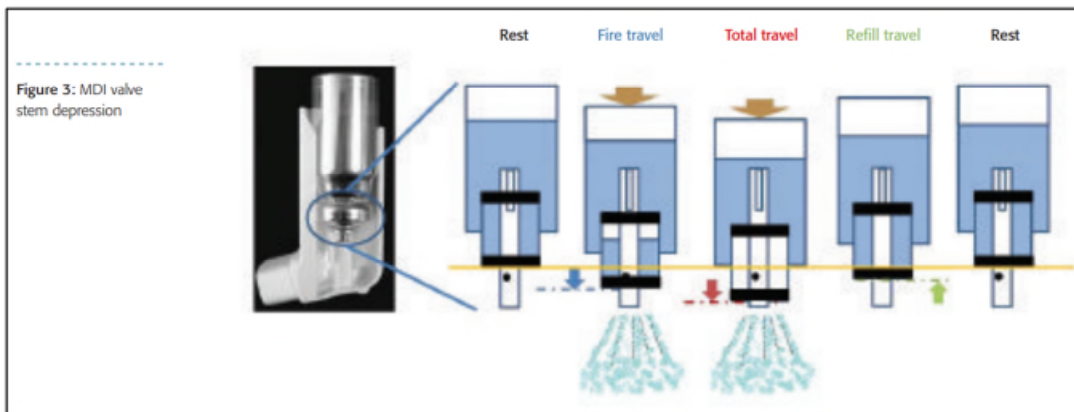

81. The 3M Infringing Products practice each limitation of claim 9 of the '177 Patent. The 3M Infringing Products include a dispenser wherein once a predetermined incomplete return stroke has been performed, the actuator member is positioned facing the following tooth of the second gear of the counter element, enabling the dispenser and the dose indicator device to be actuated once again. For example, as shown in the images below, after enough vertical distance has been traveled such that the saw-toothed ring has rotated, the castellated piece and the ring each move axially upward a certain vertical distance that is less than the distance of a complete return stroke. When the predetermined incomplete return stroke has been performed, the castellated piece is now positioned to cooperate with the following tooth of the inner ring of teeth of the saw-toothed ring. The dispenser may then be actuated again.²³

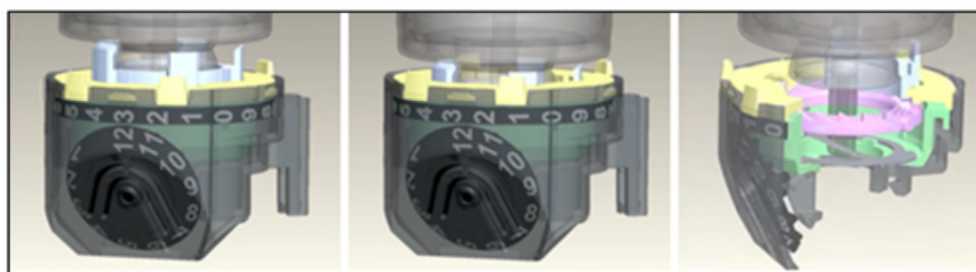

²³ See Exhibit 7 (available at <http://multimedia.3m.com/mws/media/11594790/ipt-inhalation-dc-article-sep-issue.pdf>); Exhibit 3 (available at "Inhalation Drug Delivery: Manufacturing Services from Start to Finish" video at http://www.3m.com/3M/en_US/drug-delivery-systems-us/technologies/inhalation/mdi/).

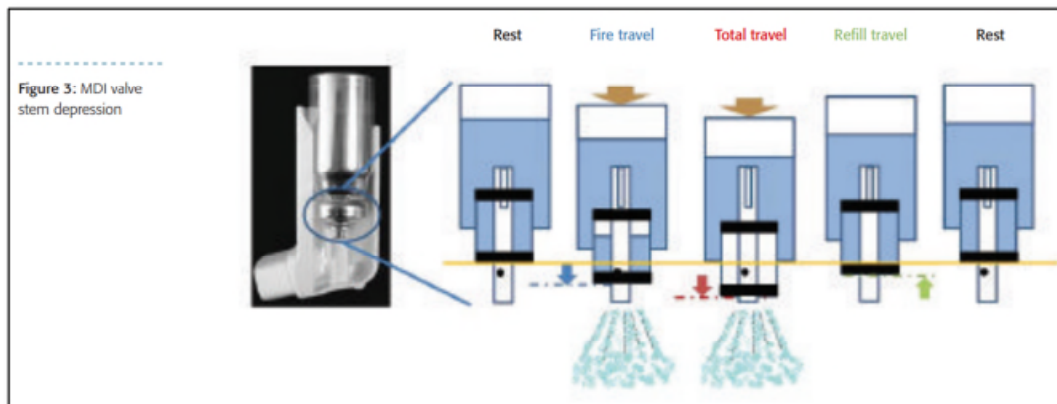

82. The 3M Infringing Products practice each limitation of claim 21 of the '177 Patent. The 3M Infringing Products include a dispenser member wherein the dispenser member is a pump or a valve. For example, as shown in the image below, the 3M Infringing Products include a valve attached to the drug canister for purposes of dispensing the medication.

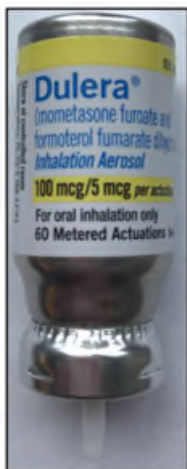

83. 3M indirectly infringes the '177 Patent by inducing infringement by others, such as manufacturers, distributors, resellers, and/or end users, of at least claims 1-3, 9, and 21 in accordance with 35 U.S.C. § 271(b) in this District and elsewhere in the United States. Merck is such a manufacturer, distributor, reseller, and/or end user. Direct infringement is the result of activities performed by the manufacturers, distributors, resellers, and/or end users of the 3M Infringing Products. For example, Merck directly infringes the '177 Patent as explained below in

Count IV. 3M had actual notice of the '177 Patent on or before the date that 3M was served with this Complaint.

84. 3M's affirmative acts of selling 3M Infringing Products, causing the 3M Infringing Products to be manufactured and distributed, maintaining its website, and/or providing instruction manuals and marketing materials for 3M Infringing Products have encouraged, aided, instructed, and/or caused others, including Merck, to make, use, sell, or offer to sell 3M Infringing Products in their normal and customary way to infringe the '177 Patent. 3M has specifically intended its manufacturers, resellers, distributors, and/or end-users to infringe the '177 Patent; further, at least as of the date the Complaint was served, 3M has been aware that these normal and customary activities would infringe the '177 Patent. 3M has performed the acts that constitute induced infringement, and would induce actual infringement, with the knowledge of the '177 Patent and with the knowledge or willful blindness that the induced acts would constitute infringement. 3M's acts constitute induced infringement and it is therefore liable as an infringer. The acts constituting inducement have occurred throughout the United States and in this District.

85. A reasonable inference to be drawn from the facts set forth is that the 3M Infringing Products are especially made or especially adapted to operate in an infringing manner as described above in paragraphs 70 to 82.

86. A reasonable inference to be drawn from the facts set forth is that the 3M Infringing Products are not staple articles or commodities of commerce, and that the use of the 3M Infringing Products is required for operation. Any other use would be unusual, far-fetched, illusory, impractical, occasional, aberrant, or experimental.

87. The 3M Infringing Products are each a material part of the invention of the '177 Patent and are especially made for the infringing manufacture, sale, and use of 3M Infringing Products as described above in paragraphs 70 to 82. Because the sales, offers for sale, use, and manufacture of 3M Infringing Products infringe the '177 Patent, 3M's sales of the 3M Infringing Products have no substantial non-infringing uses.

88. In particular, 3M has offered to sell, or sold, or imported the 3M Infringing Products, which constitute a material part of the invention of the '177 Patent, knowing the same to be especially made or especially adapted for use in an infringement of the '177 Patent, and knowing that the same are not staple articles or commodities of commerce suitable for substantial non-infringing use.

89. 3M received actual notice of its infringement of the '177 Patent through at least the service of this Complaint.

90. Thus, a reasonable inference to be drawn is that 3M further indirectly infringes the '177 Patent by contributing to the infringement by others, such as end users, and 3M has contributed to and/or continues to contribute to infringement of at least claims 1-3, 9, and 21 of the '177 Patent, pursuant to 35 U.S.C. § 271(c), by virtue of its offer to sell, or sale, or import into the United States a component of a patented machine, manufacture, combination, or composition, or a material or apparatus for use in practicing a patented process, which are not staple articles or commodities of commerce and which have no substantial non-infringing use. The acts constituting contributory infringement have occurred throughout the United States and in this District.

91. 3M's acts of infringement have caused damage to Aptar. Aptar is entitled to recover from 3M the damages sustained by Aptar as a result of 3M's wrongful acts in an amount subject to proof at trial.

COUNT IV.
MERCK'S INFRINGEMENT OF U.S. PATENT NO. 8,936,177

92. Aptar repeats and realleges the allegations in paragraphs 1-91 as if fully set forth herein. As described below, Merck has infringed and/or continues to infringe the '177 Patent.

93. The Merck Infringing Products infringe at least claims 1-3, 9, and 21 of the '177 Patent. Merck makes, uses, sells, offers for sale, imports, exports, supplies, and/or distributes within the United States these products and thus directly infringes at least claims 1-3, 9, and 21 of the '177 Patent.

94. The Merck Infringing Products practice each limitation of claim 1 of the '177 Patent. The Merck Infringing Products include a stationary body including at least one stationary gear. For example, as shown in the images below, the Merck Infringing Products include a blue plastic housing and a white plastic disc with at least one stationary gear. This disc is the "lid" of the clear plastic cup that holds the numbered dials, and either the disc or the disc and the housing are stationary with respect to the reservoir.



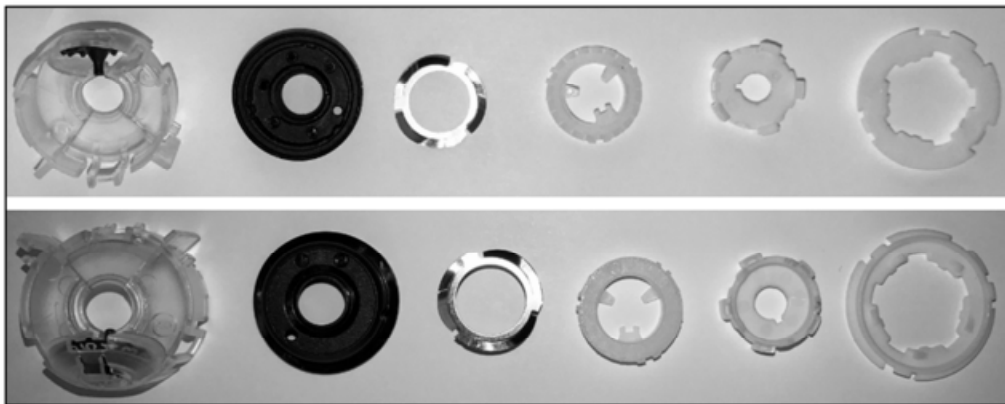

95. The Merck Infringing Products include a fluid reservoir disposed in said body so as to be axially displaceable relative to said body. For example, the Merck Infringing Products include a drug canister that sits within the blue housing and inside the outer circumference of the lid. As shown in the images below, when the drug canister is pressed down, it moves axially relative to either the lid or the lid and the housing.



96. The Merck Infringing Products include a dispenser member mounted on said reservoir. For example, as shown in the image below, the Merck Infringing Products include a valve attached to the drug canister for purposes of dispensing the medication.



97. The Merck Infringing Products include a dose indicator device, including a counter element that is displaceable axially and in rotation relative to said body. The dose indicator device indicates the number of doses of fluid that have been dispensed or that remain to be dispensed from said reservoir. For example, as shown in the images below, the Merck Infringing Products include black dials that include numbered dose values and a saw-toothed ring. The ring is positioned under the lid and the castellated piece. When the ring moves axially downward relative to either the lid or the lid and the housing, the ring also rotates relative to either the lid or the lid and the housing. As shown in the images below, the black dials include numbered values corresponding to the number of doses of medication that have been dispensed or remain to be dispensed from the drug canister.

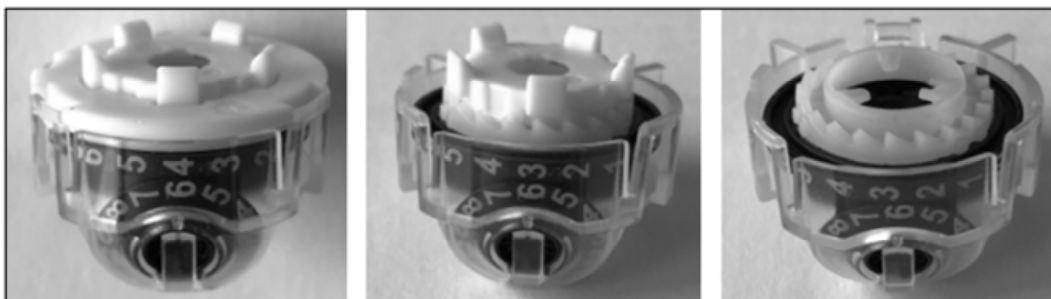

98. The Merck Infringing Products include a counter element that cooperates, while the dispenser is being actuated, firstly with said at least one stationary gear of said body, and secondly with said reservoir, so that the dose indicator device is actuated once the dispenser has performed a predetermined incomplete actuation stroke, even if the dispenser does not perform a complete actuation stroke. For example, as shown in the images below, while the Merck Infringing Products are actuated, the saw-toothed ring cooperates with the stationary gear of the lid and drug canister. When the drug canister is pressed down far enough that the ring rotates—even if the canister is not pressed down further to complete the stroke—the black dials change the displayed dose value.²⁴

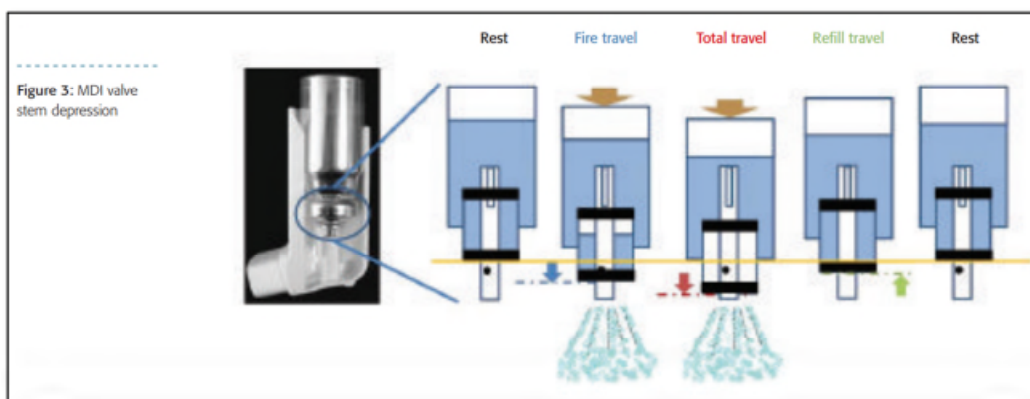
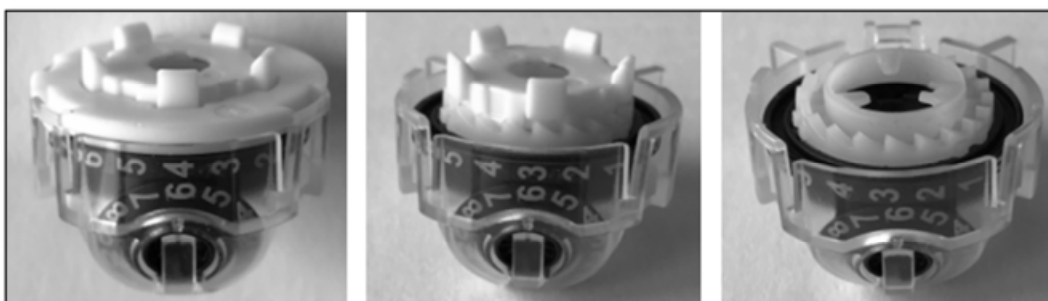

²⁴ See Exhibit 7 (available at <http://multimedia.3m.com/mws/media/1159479O/ipt-inhalation-dc-article-sep-issue.pdf>); See Exhibit 5 (available at <http://multimedia.3m.com/mws/media/1159495O/statistical-tolerance-analysis-tools-in-dose-counters.pdf>).

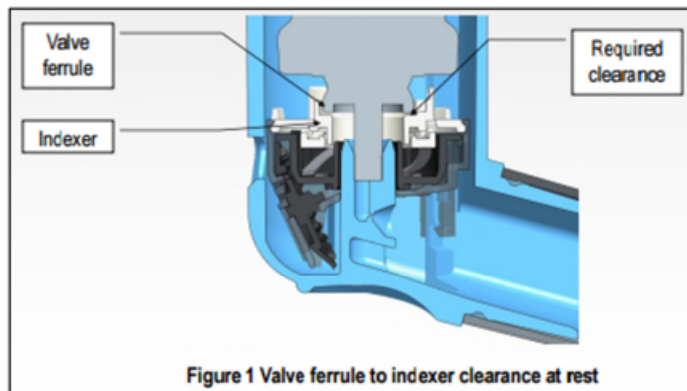

99. The Merck Infringing Products practice each limitation of claim 2 of the '177 Patent. The Merck Infringing Products include a fluid dispenser wherein, during the return stroke of the dispenser after dispensing a dose, said dose indicator device prevents the fluid from being expelled again until said dispenser has completed a predetermined incomplete return stroke, said dispenser and said dose indicator device being capable of being actuated once again, once the predetermined incomplete return stroke has been performed, even if the dispenser does not perform the complete return stroke and said dispenser is actuated once again before returning to its rest position. For example, as shown in the image below, after the a dose of medication has been dispensed and while the drug canister is performing a “refill travel” action upward to its rest position, no further medication may be expelled until the canister has traveled a certain vertical distance. This vertical distance is less than or equal to the distance required to perform the complete return stroke.²⁵

²⁵ See Exhibit 7 (available at <http://multimedia.3m.com/mws/media/11594790/ipt-inhalation-dc-article-sep-issue.pdf>).

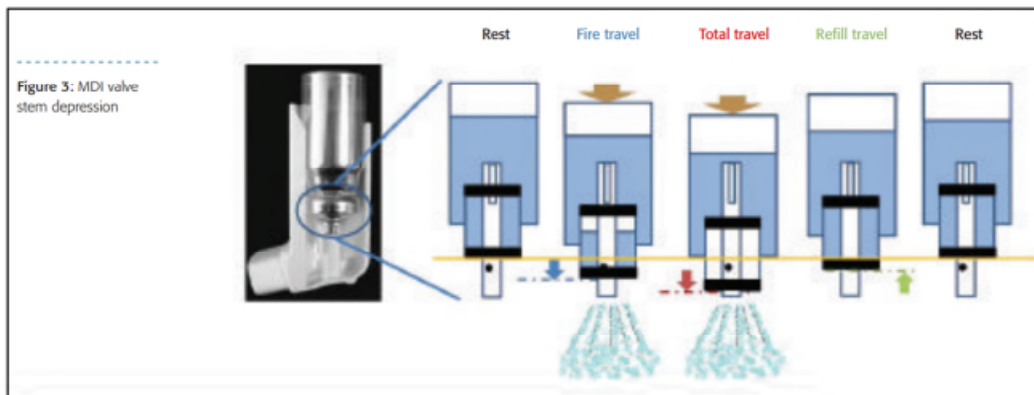

100. The Merck Infringing Products practice each limitation of claim 3 of the '177 Patent. The Merck Infringing Products include a stationary body in which said body includes a stationary gear co-operating with a first gear of said counter element. For example, as shown in the image below, the lid includes a stationary gear that cooperates with the outer ring of teeth of the saw-toothed ring.

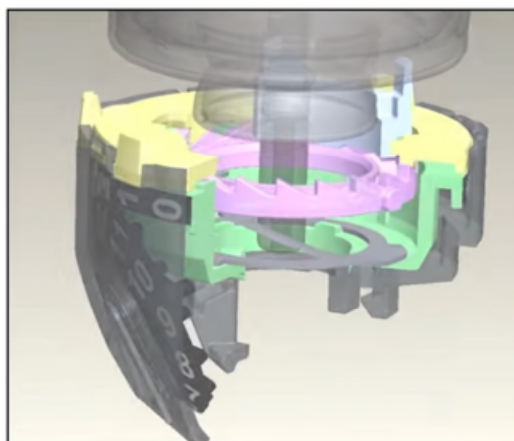

101. The Merck Infringing Products include a counter element in which said counter element includes a second gear co-operating with an actuator gear of an actuator member of the dispenser. For example, as shown in the image below, the saw-toothed ring includes an inner ring of teeth that cooperate with a gear included on the castellated piece.

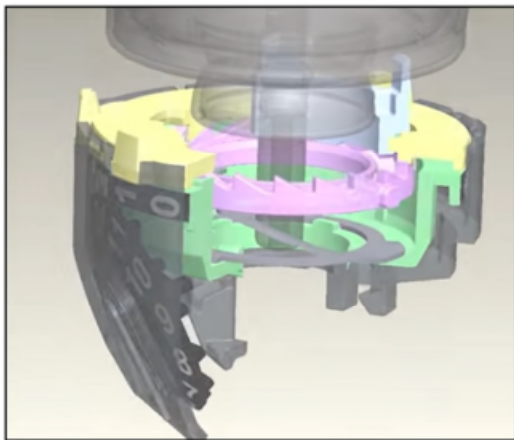

102. The Merck Infringing Products include a second gear in which the teeth of said second gear and/or of said actuator gear are made so that axial displacement of the actuator member causes said counter element to be displaced axially and in rotation. For example, as shown in the images below, the inner ring of teeth on the saw-toothed ring cooperate with the castellated piece, and when the castellated piece moves axially downward, the ring also moves axially downward and rotates.²⁶

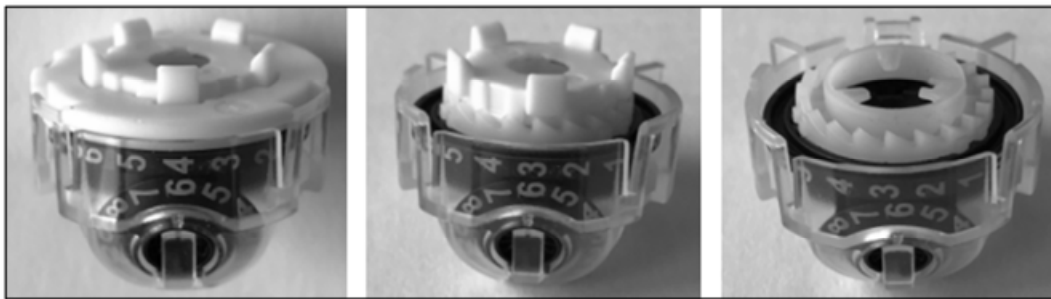

²⁶ Exhibit 3 (available at “Inhalation Drug Delivery: Manufacturing Services from Start to Finish” video at http://www.3m.com/3M/en_US/drug-delivery-systems-us/technologies/inhalation/mdi/).

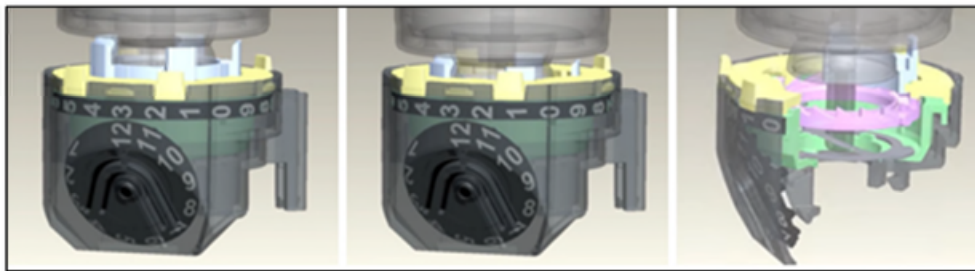

103. The Merck Infringing Products include a stationary gear in which the stationary gear prevents said counter element from turning until said counter element no longer co-operates with said stationary gear, after a predetermined axial displacement of said counter element corresponding to said predetermined incomplete actuation stroke of the dispenser. For example, as shown in the images below the lid includes a stationary gear that prevents the saw-toothed ring from turning until the ring no longer co-operates with the lid. When the ring is at a rest position, such cooperation prevents the ring from rotating. As shown in the images below, when the ring moves axially downward and no longer cooperates with the lid, the ring turns. The axial distance required to cause the ring to turn is less than the distance of a complete actuation stroke.²⁷

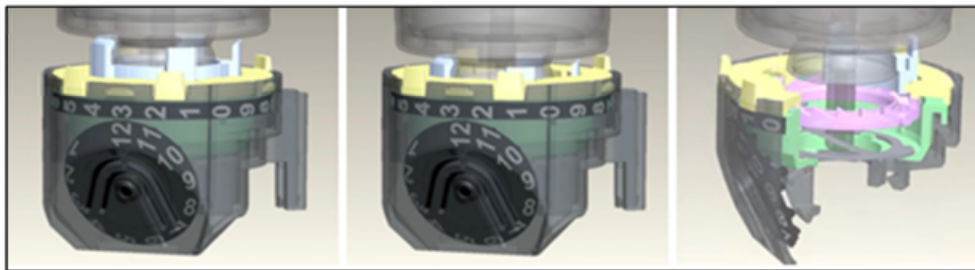

²⁷ See Exhibit 7 (available at <http://multimedia.3m.com/mws/media/11594790/ipt-inhalation-dc-article-sep-issue.pdf>); Exhibit 3 (available at “Inhalation Drug Delivery: Manufacturing Services from Start to Finish” video at http://www.3m.com/3M/en_US/drug-delivery-systems-us/technologies/inhalation/mdi/).

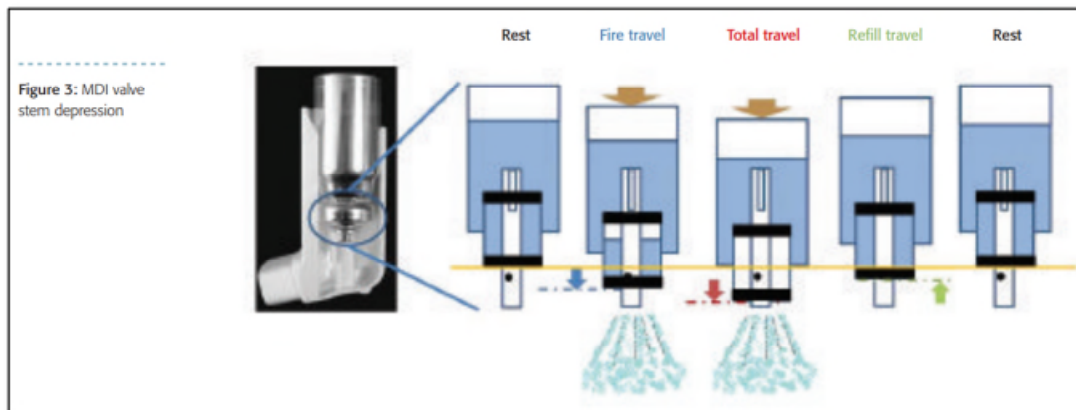

104. The Merck Infringing Products practice each limitation of claim 9 of the '177 Patent. The Merck Infringing Products include a dispenser wherein once a predetermined incomplete return stroke has been performed, the actuator member is positioned facing the following tooth of the second gear of the counter element, enabling the dispenser and the dose indicator device to be actuated once again. For example, as shown in the images below, after enough vertical distance has been traveled such that the saw-toothed ring has rotated, the castellated piece and the ring each move axially upward a certain vertical distance that is less than the distance of a complete return stroke. When the predetermined incomplete return stroke has been performed, the castellated piece is now positioned to cooperate with the following tooth of the inner ring of teeth of the saw-toothed ring. The dispenser may then be actuated again.²⁸

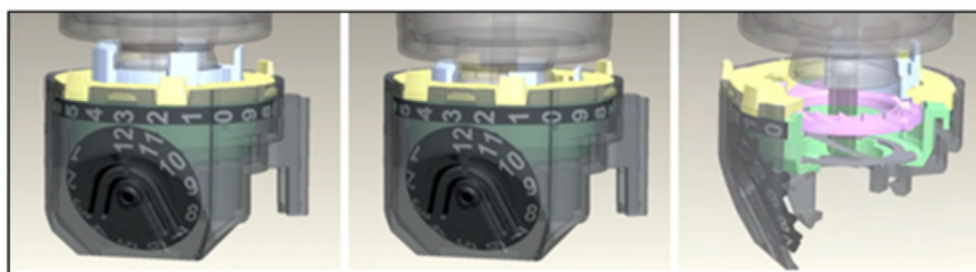

²⁸ See Exhibit 7 (available at <http://multimedia.3m.com/mws/media/11594790/ipt-inhalation-dc-article-sep-issue.pdf>); Exhibit 3 (available at "Inhalation Drug Delivery: Manufacturing Services from Start to Finish" video at http://www.3m.com/3M/en_US/drug-delivery-systems-us/technologies/inhalation/mdi/).

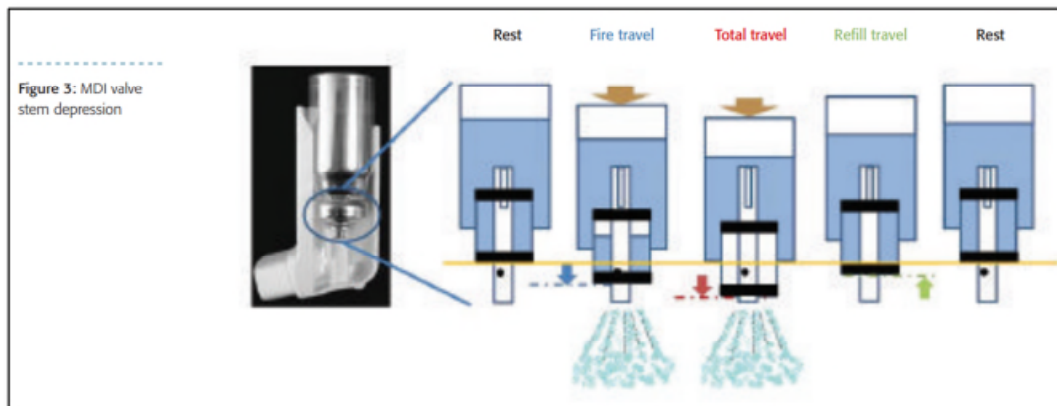

105. The Merck Infringing Products practice each limitation of claim 21 of the '177 Patent. The Merck Infringing Products include a dispenser member wherein the dispenser member is a pump or a valve. For example, as shown in the image below, the Merck Infringing Products include a valve attached to the drug canister for purposes of dispensing the medication.



106. Merck indirectly infringes the '177 Patent by inducing infringement by others, such as manufacturers, distributors, resellers, and/or end users, of at least claims 1-3, 9, and 21 in accordance with 35 U.S.C. § 271(b) in this District and elsewhere in the United States. 3M is such a manufacturer, distributor, reseller, and/or end user. Direct infringement is the result of activities performed by the manufacturers, distributors, resellers, and/or end users of the Merck Infringing Products. For example, 3M directly infringes the '177 Patent as explained above in

Count III. Merck had actual notice of the '177 Patent on or before the date that Merck was served with this Complaint.

107. Merck's affirmative acts of selling Merck Infringing Products, causing the Merck Infringing Products to be manufactured and distributed, employing pharmaceutical sales specialists, maintaining its website, and/or providing instruction manuals, marketing materials, coupons, a doctor portal for samples, and label/package inserts for Merck Infringing Products have encouraged, aided, instructed, and/or caused others, including 3M, to make, use, sell, or offer to sell Merck Infringing Products in their normal and customary way to infringe the '177 Patent. Merck has specifically intended its manufacturers, resellers, distributors, and/or end-users to infringe the '177 Patent; further, at least as of the date the Complaint was served, Merck has been aware that these normal and customary activities would infringe the '177 Patent. Merck has performed the acts that constitute induced infringement, and would induce actual infringement, with the knowledge of the '177 Patent and with the knowledge or willful blindness that the induced acts would constitute infringement. Merck's acts constitute induced infringement and it is therefore liable as an infringer. The acts constituting inducement have occurred throughout the United States and in this District.

108. Merck's acts of infringement have caused damage to Aptar. Aptar is entitled to recover from Merck the damages sustained by Aptar as a result of Merck's wrongful acts in an amount subject to proof at trial.

109. Merck received actual notice of its infringement of the '177 Patent through at least the service of this Complaint.

DEMAND FOR JURY TRIAL

Aptar hereby demands a trial by jury as to all issues so triable.

PRAYER FOR RELIEF

WHEREFORE, Aptar respectfully requests that this Court enter judgment in its favor and grant the following relief:

- A. Adjudge that Defendants infringe the Patents-in-Suit;
- B. Award Aptar damages in an amount adequate to compensate Aptar for Defendants' infringement of the Patents-in-Suit, but in no event less than a reasonable royalty under 35 U.S.C. § 284;
- C. Award enhanced damages pursuant to 35 U.S.C. § 284;
- D. Award Aptar pre-judgment and post-judgment interest to the full extent allowed under the law, as well as its costs;
- E. Enter an order finding that this is an exceptional case and awarding Aptar its reasonable attorneys' fees pursuant to 35 U.S.C. § 285;
- F. Award a compulsory forward royalty;
- G. Order an accounting of damages; and
- H. Award such other relief as the Court may deem appropriate and just under the circumstances.

Dated: June 7, 2017

Respectfully submitted,

S/Gary Zhao

SMITHAMUNDSEN

Gary Zhao
Illinois State Bar No. 6279527
gzhao@salawaus.com
SmithAmundsen
150 North Michigan Avenue
Suite 3300
Chicago, Illinois 60601
(312) 894-3377

MCKOOL SMITH, P.C.

Robert M. Manley (*pro hac vice pending*)
Texas State Bar No. 00787955
rmanley@mckoolsmith.com
Ashley Moore (*pro hac vice pending*)
Texas State Bar No. 24074748
amoore@mckoolsmith.com
Ryan Hargrave (*pro hac vice pending*)
Texas State Bar No. 24071516
rhargrave@mckoolsmith.com

300 Crescent Court, Suite 1500
Dallas, Texas 75201

Telephone: (214) 978-4000
Telecopier: (214) 978-4044

ATTORNEYS FOR PLAINTIFFS
AptarGroup Inc. and Aptar France, S.A.S.

CERTIFICATE OF SERVICE

The undersigned hereby certifies that all counsel of record who are deemed to have consented to electronic service are being served with this document via the Court's CM/ECF system pursuant to Local Rule CV-5(a) on June 7, 2017.

S/ Gary Zhao

Gary Zhao