

IN THE UNITED STATES DISTRICT COURT
FOR THE DISTRICT OF DELAWARE

BLACKBERRY LIMITED,)	
)	
Plaintiff,)	REDACTED – PUBLIC VERSION
)	
v.)	
)	C.A. No. 17-155-RGA
NOKIA CORPORATION, NOKIA SOLUTIONS)	
AND NETWORKS OY, NOKIA SOLUTIONS)	
AND NETWORK HOLDINGS USA INC., AND)	JURY TRIAL DEMANDED
NOKIA SOLUTIONS AND NETWORKS US)	
LLC,)	
)	
Defendants.)	

AMENDED COMPLAINT FOR PATENT INFRINGEMENT

Plaintiff BlackBerry Limited (“BlackBerry”) submits this Amended Complaint against Defendants Nokia Corporation, Nokia Solutions and Networks Oy, Nokia Solutions and Networks Holdings USA Inc., and Nokia Solutions and Networks US LLC (collectively, “Nokia” or “Defendants”) and alleges as follows:

INTRODUCTION

1. For more than 30 years, BlackBerry has been a leading innovator in the mobile communications industry. BlackBerry’s cutting-edge wireless communication products and services have transformed the way people around the world connect, converse, and share digital information. Today BlackBerry secures, connects, and mobilizes the enterprise. For the enterprise of things, BlackBerry provides a software platform and devices that enable and manage security, mobility, and communications between and among hardware, programs, mobile apps, and the internet of things.

2. BlackBerry also developed key innovations that underlie 3G and 4G mobile communications technologies, such as Long-Term Evolution (LTE), including LTE Advanced,

and Universal Terrestrial Radio Access Network (UTRAN) technologies. Defendants' unauthorized usage of BlackBerry's and its predecessors' contributions to these technologies is the subject of this case.

3. BlackBerry was founded in 1984 in Waterloo, Ontario, by two engineering students, Mike Lazaridis and Douglas Fregin. In its early years, the company — then named Research In Motion (“RIM”) — focused its inventive energies on wireless data transmission.

4. In the course of developing its ground-breaking mobile communications devices, BlackBerry and its family of companies invented new technologies that cover key features of LTE and Universal Mobile Telecommunications System (UMTS)/UTRAN communications. To take one example, enabling seamless voice services for LTE users posed a critical challenge that BlackBerry was able to address. Commercial acceptance of LTE technology required enabling LTE users to utilize 3G and 2G networks for voice calls without the slow call-setup times that can degrade the user experience. RIM identified the problem of slow call-setup and developed improvements to the Circuit Switched Fallback (CSFB) feature. BlackBerry's solution became part of the LTE wireless communication standards (“LTE Standards”).

5. Throughout its history, BlackBerry has demonstrated a commitment to innovation, including through its investments in research and development, which have totaled more than \$5.5 billion over the past five years. BlackBerry has protected the technical innovations resulting from these investments, including through seeking patent protection in the United States.

6. BlackBerry owns United States Patent Nos. 6,996,418, 8,254,246, 8,494,090, 7,529,305, 8,861,433, 9,426,697, 9,253,772, 8,897,192, 9,125,202, 8,243,683, and 8,644,829, which are collectively the “Asserted Patents” in this action. Nokia infringes the Asserted Patents

by using, without authorization, BlackBerry's proprietary technology in a number of Nokia's commercial products and services, including LTE- and UMTS/UTRAN-compliant products and services. These include Nokia's Flexi line products, as well as associated Nokia software such as the Nokia Liquid Radio Software Suite.

7. By this action, BlackBerry seeks to obtain recompense for Nokia's unauthorized use of BlackBerry's patented technology.

THE PARTIES

8. Plaintiff BlackBerry Limited is a Canadian corporation with its principal place of business at 2200 University Avenue East, Waterloo, Ontario, Canada N2K 0A7. BlackBerry Limited is the owner of the intellectual property rights at issue in this action.

9. On information and belief, Defendant Nokia Corporation is a Finnish company with its principal place of business at Karaportti 3, 02610 Espoo, Finland. On information and belief, Nokia Corporation is the parent company of the consolidated operating segments that Nokia designates as the "Nokia Group."

10. On information and belief, Defendant Nokia Solutions and Networks Oy (a/k/a Nokia Solutions and Networks Corporation) is a Finnish company with its principal place of business at Karaportti 3, 02610 Espoo, Finland. On information and belief, Nokia Solutions and Networks Oy is a wholly-owned subsidiary of Nokia Solutions and Networks B.V., which is a wholly-owned subsidiary of Nokia Finance International B.V., which is a wholly-owned subsidiary of Nokia Corporation. On information and belief, Nokia Solutions and Networks Oy is the entity within the Nokia Group that operates and oversees the "Nokia Networks" business unit. According to Nokia Corporation's 2015 20-F Report, Nokia Networks develops, makes, and sells products for "mobile network infrastructure, fixed network infrastructure, IP routing

and optical networks as well as the software platforms and applications to optimize operations, business, network performance, and customer experience.” Nokia Networks’ mobile network infrastructure business is associated with its Mobile Networks business group within the Nokia Networks business unit.

11. On information and belief, Defendant Nokia Solutions and Networks Holdings USA Inc. is a Delaware corporation with a principal place of business at 6000 Connection Drive, Irving, Texas 75039. On information and belief, Nokia Solutions and Networks Holdings USA Inc. is a wholly-owned subsidiary of Nokia Solutions and Networks B.V., which is a wholly-owned subsidiary of Nokia Finance International B.V., which is a wholly-owned subsidiary of Nokia Corporation. On information and belief, Nokia Solutions and Networks Holdings USA Inc. provides support services to Nokia’s mobile network infrastructure business customers in the United States.

12. On information and belief, Defendant Nokia Solutions and Networks US LLC is a limited liability company organized under the laws of Delaware with a principal place of business at 6000 Connection Drive, Irving, Texas 75039. On information and belief, Nokia Solutions and Networks US LLC is a wholly-owned subsidiary of Nokia Solutions and Networks Holdings USA Inc. On information and belief, Nokia Solutions and Networks US LLC (together with Nokia Solutions and Networks Holdings USA Inc., “Nokia Solutions and Networks US”) is a sales company for Nokia’s mobile network infrastructure business in the United States.

13. On information and belief, Nokia Corporation, together with its subsidiaries and its affiliates, including, but not limited to, Nokia Solutions and Networks Oy, Nokia Solutions and Networks Holdings USA Inc., and Nokia Solutions and Networks US LLC, designs, develops, markets, and sells telecommunications products and services, including mobile

infrastructure products and services, in the United States. Nokia imports such products into the United States and sells, offers for sale, deploys, and supports such products and services in the United States, including within this judicial district.

JURISDICTION AND VENUE

14. This is an action for patent infringement arising under the patent laws of the United States, 35 U.S.C. § 1 *et seq.*, including but not limited to 35 U.S.C. § 271.

15. This Court has subject matter jurisdiction over this controversy under 28 U.S.C. §§ 1331 and 1338(a).

16. This Court has personal jurisdiction over each of the Nokia Defendants. The Defendants are each subject to personal jurisdiction in this Court because, *inter alia*, and upon information and belief, each Defendant has established the minimum contacts with the forum state of Delaware necessary for the Court to exercise personal jurisdiction over that Defendant.

17. The Defendants are each subject to personal jurisdiction in this Court under the Delaware Long-Arm Statute, 10 Del. Code § 3104, and under the U.S. Constitution, because, on information and belief, they have transacted and continue to transact business with persons in the state of Delaware, directly and/or through third parties, by: importing, offering to sell, or selling into and within Delaware products and services that infringe BlackBerry's Asserted Patents; and using in Delaware, or encouraging and supporting the deployment and use in Delaware of, products and services that infringe BlackBerry's Asserted Patents. These acts by each Defendant have caused and continue to cause injury to BlackBerry within this judicial district. Upon information and belief, Nokia derives substantial revenue from the sale, deployment, and use of infringing products and services within this judicial district. Accordingly, each Defendant has systematic and continuous contacts with and within Delaware, does business in Delaware, and

has purposefully availed itself of the benefits of Delaware, all in connection with its business relating to products and services that infringe BlackBerry's Asserted Patents, such that each Defendant should reasonably anticipate being sued in the state of Delaware, and this Court's exercise of jurisdiction over each Defendant would not offend traditional notions of fair play and substantial justice.

18. This Court also has personal jurisdiction over Defendant Nokia Solutions and Networks US LLC and Defendant Nokia Solutions and Networks Holdings USA Inc. because each of them is incorporated in the state of Delaware, and therefore resides in Delaware.

19. This Court also has personal jurisdiction over Defendant Nokia Corporation because Nokia Corporation previously has availed itself of this forum for the purpose of litigating its patent infringement disputes. *See, e.g., Nokia Corp. et al. v. Viewsonic Corp.*, No. 1:12-cv-0554 (D. Del.); *Nokia Corp. et al. v. HTC Corp. et al.*, Nos. 1:12-cv-551 (D. Del.).

20. Venue is proper in this judicial district pursuant to 28 U.S.C. §§ 1391(a)-(c) for Nokia Corporation and Nokia Solutions and Networks Oy. Venue is proper in this judicial district pursuant to 28 U.S.C. § 1400(b) for Nokia Solutions and Networks Holdings USA Inc. and Nokia Solutions and Networks US LLC.

BLACKBERRY'S PATENTS

('418 Patent)

21. United States Patent No. 6,996,418 (the "'418 patent") is entitled "Apparatus and Method for OFDM Data Communications," and was issued on February 7, 2006. A true and correct copy of the '418 patent is attached as Exhibit A.

22. The '418 patent was filed on April 26, 2001, as U.S. Patent Application No. 09/842,128, and claims priority to U.S. Provisional Patent Application No. 60/258,558, which was filed on December 29, 2000.

23. BlackBerry is the owner of all rights, title, and interest in and to the '418 patent, with the full and exclusive right to bring suit to enforce the '418 patent, including the right to recover for past infringement.

24. The '418 patent covers technology used in products and services that practice the LTE Standards. Specifically, some or all claims of the '418 patent, including those claims specifically discussed below, are essential to implementations of the LTE Standards that are set forth, *inter alia*, at least in the 3rd Generation Partnership Project ("3GPP") TS 36.300, 3GPP TS 36.321, 3GPP TS 36.211, 3GPP TS 36.212, and 3GPP TS 36.213 specifications since at least Version 8.12.0 of the 3GPP TS 36.300 specification.

('246 Patent)

25. United States Patent No. 8,254,246 (the "'246 patent") is entitled "Scattered Pilot Pattern and Channel Estimation Method for MIMO-OFDM Systems," and was issued on August 28, 2012. A true and correct copy of the '246 patent is attached as Exhibit B.

26. The '246 patent was filed on May 19, 2009, as U.S. Patent Application No. 12/468,624, is a continuation of U.S. Patent Application No. 11/819,690, filed on June 28, 2007, which is a continuation of U.S. Patent Application No. 10/038,883, filed on January 8, 2002, and claims priority to U.S. Provisional Patent Application No. 60/329,509, which was filed on October 17, 2001.

27. BlackBerry is the owner of all rights, title, and interest in and to the '246 patent, with the full and exclusive right to bring suit to enforce the '246 patent, including the right to recover for past infringement.

28. The '246 patent covers technology used in products and services that practice the LTE Standards. Specifically, some or all claims of the '246 patent, including those claims specifically discussed below, are essential to implementations of the LTE Standards that are set forth, *inter alia*, at least in the 3GPP TS 36.211 and 3GPP TS 36.300 specifications since at least Version 8.9.0 of the 3GPP TS 36.211 specification.

('090 Patent)

29. United States Patent No. 8,494,090 (the "'090 patent") is entitled "Detecting the Number of Transmit Antennas in a Base Station," and was issued on July 23, 2013. A true and correct copy of the '090 patent is attached as Exhibit C.

30. The '090 patent was filed on September 10, 2012, as U.S. Patent Application No. 13/608,184, is a continuation of U.S. Patent Application No. 12/221,867, which was filed on August 7, 2008, and claims priority to U.S. Provisional Patent Application No. 60/954,357, which was filed on August 7, 2007.

31. BlackBerry is the owner of all rights, title, and interest in and to the '090 patent, with the full and exclusive right to bring suit to enforce the '090 patent, including the right to recover for past infringement.

32. The '090 patent covers technology used in products and services that practice the LTE Standards. Specifically, some or all claims of the '090 patent, including those claims specifically discussed below, are essential to implementations of the LTE Standards that are set

forth, *inter alia*, at least in the 3GPP TS 36.211 and 3GPP TS 36.212 specifications since at least Version 8.8.0 of the 3GPP TS 36.212 specification.

(’305 Patent)

33. United States Patent No. 7,529,305 (the “’305 patent”) is entitled “Combination of Space-Time Coding and Spatial Multiplexing, and the Use of Orthogonal Transformation in Space-Time Coding,” and was issued on May 5, 2009. A true and correct copy of the ’305 patent is attached as Exhibit D.

34. The ’305 patent was filed on April 23, 2003, as U.S. Patent Application No. 10/399,859, which is the U.S. national stage entry application of PCT International Patent Application No. PCT/RU00/00426, which was filed on October 27, 2000.

35. BlackBerry is the owner of all rights, title, and interest in and to the ’305 patent, with the full and exclusive right to bring suit to enforce the ’305 patent, including the right to recover for past infringement.

36. The ’305 patent covers technology used in products and services that practice the LTE Standards. Specifically, some or all claims of the ’305 patent, including those claims specifically discussed below, are essential to implementations of the LTE Standards that are set forth, *inter alia*, at least in the 3GPP TS 36.211 and 3GPP TS 36.322 specifications since at least Version 8.8.0 of the 3GPP TS 36.322 specification.

(’433 Patent)

37. United States Patent No. 8,861,433 (the “’433 patent”) is entitled “Method for Accessing a Service Unavailable through a Network Cell,” and was issued on October 14, 2014. A true and correct copy of the ’433 patent is attached as Exhibit E.

38. The '433 patent was filed on June 16, 2010, as U.S. Patent Application No. 12/817,154, and claims priority to U.S. Provisional Patent Application No. 61/187,636, which was filed on June 16, 2009.

39. BlackBerry is the owner of all rights, title, and interest in and to the '433 patent, with the full and exclusive right to bring suit to enforce the '433 patent, including the right to recover for past infringement.

40. The '433 patent covers technology used in products and services that practice the LTE Standards and UMTS/UTRAN wireless communication standards ("UMTS/UTRAN Standards"). Specifically, some or all claims of the '433 patent, including those claims specifically discussed below, are essential to implementations of the LTE and UMTS/UTRAN Standards that are set forth, *inter alia*, at least in the 3GPP TS 23.221, 3GPP TS 23.272, 3GPP TS 24.008, 3GPP TS 24.301, 3GPP TS 25.331, 3GPP TS 36.300, 3GPP TS 36.304, and 3GPP TS 36.331 specifications since at least Version 9.17.0 of the 3GPP TS 36.331 specification.

('697 Patent)

41. United States Patent No. 9,426,697 (the "'697 patent") is entitled "Method for Accessing a Service Unavailable through a Network Cell," and was issued on August 23, 2016. A true and correct copy of the '697 patent is attached as Exhibit F.

42. The '697 patent was filed on September 17, 2014, as U.S. Patent Application No. 14/489,220, is a continuation of U.S. Patent Application No. 12/817,154, which was filed on June 16, 2010, and claims priority to U.S. Provisional Patent Application No. 61/187,636, which was filed on June 16, 2009.

43. BlackBerry is the owner of all rights, title, and interest in and to the '697 patent, with the full and exclusive right to bring suit to enforce the '697 patent, including the right to recover for past infringement.

44. The '697 patent covers technology used in products and services that practice the LTE and UMTS/UTRAN Standards. Specifically, some or all claims of the '697 patent, including those claims specifically discussed below, are essential to implementations of the LTE and UMTS/UTRAN Standards that are set forth, *inter alia*, at least in the 3GPP TS 23.221, 3GPP TS 23.272, 3GPP TS 24.008, 3GPP TS 24.301, 3GPP TS 25.331, 3GPP TS 36.300, 3GPP TS 36.304, and 3GPP TS 36.331 specifications since at least Version 9.17.0 of the 3GPP TS 36.331 specification.

('772 Patent)

45. United States Patent No. 9,253,772 (the "'772 patent") is entitled "System and Method for Multi-Carrier Network Operation," and was issued on February 2, 2016. A true and correct copy of the '772 patent is attached as Exhibit G.

46. The '772 patent was filed on May 16, 2014, as U.S. Patent Application No. 14/280,365, is a continuation of U.S. Patent Application No. 13/430,632, which was filed on March 26, 2012, and is the U.S. national stage entry application of PCT International Patent Application No. PCT/US10/050232, which was filed on September 24, 2010, and claims priority to U.S. Provisional Patent Application Nos. 61/293,521 (filed on January 8, 2010) and 61/246,061 (filed on September 25, 2009).

47. BlackBerry is the owner of all rights, title, and interest in and to the '772 patent, with the full and exclusive right to bring suit to enforce the '772 patent, including the right to recover for past infringement.

48. The '772 patent covers technology used in products and services that practice the LTE Standards. Specifically, some or all claims of the '772 patent, including those claims specifically discussed below, are essential to implementations of the LTE Standards that are set forth, *inter alia*, at least in the 3GPP TS 36.212, 3GPP TS 36.213, 3GPP TS 36.300, and 3GPP TS 36.331 specifications since at least Version 10.19.0 of the 3GPP TS 36.331 specification.

('192 Patent)

49. United States Patent No. 8,897,192 (the "'192 patent") is entitled "System and Method for Discontinuous Reception Control Start Time," and was issued on November 25, 2014. A true and correct copy of the '192 patent is attached as Exhibit H.

50. The '192 patent was filed on March 17, 2014, as U.S. Patent Application No. 14/216,181, is a continuation of U.S. Patent Application No. 13/287,731, which was filed on November 2, 2011, which a continuation of U.S. Patent Application No. 11/957,624, which was filed on December 17, 2007, and claims priority to U.S. Provisional Patent Application No. 60/972,583, which was filed on September 14, 2007.

51. BlackBerry is the owner of all rights, title, and interest in and to the '192 patent, with the full and exclusive right to bring suit to enforce the '192 patent, including the right to recover for past infringement.

52. The '192 patent covers technology used in products and services that practice the LTE Standards. Specifically, some or all claims of the '192 patent, including those claims specifically discussed below, are essential to implement the LTE Standards in a commercially viable manner as set forth, *inter alia*, at least in the 3GPP TS 36.321, 3GPP TS 36.331, and 3GPP TS 36.211 specifications since at least Version 8.21.0 of the 3GPP TS 36.331 specification.

(’202 Patent)

53. United States Patent No. 9,125,202 (the “’202 patent”) is entitled “Multi-Beam Cellular Communication System,” and was issued on September 1, 2015. A true and correct copy of the ’202 patent is attached as Exhibit I.

54. The ’202 patent was filed on April 21, 2014, as U.S. Patent Application No. 14/257,424, and is a continuation of U.S. Patent Application No. 13/620,514, filed on September 14, 2012, which is a continuation of U.S. Patent Application No. 12/880,246, filed on September 13, 2010, which is a division of U.S. Patent Application No. 10/385,792, filed on March 11, 2003.

55. BlackBerry is the owner of all rights, title, and interest in and to the ’202 patent, with the full and exclusive right to bring suit to enforce the ’202 patent, including the right to recover for past infringement.

56. The ’202 patent covers technology used in products and services that practice the LTE Standards. Specifically, some or all claims of the ’202 patent, including those claims specifically discussed below, are essential to implementations of the LTE Standards that are set forth, *inter alia*, at least in the 3GPP TS 36.201, 3GPP TS 36.211, 3GPP TS 36.212, 3GPP TS 36.213, and 3GPP TS 36.300 specifications since at least Version 9.4.0 of the 3GPP TS 36.212 specification.

(’683 Patent)

57. United States Patent No. 8,243,683 (the “’683 patent”) is entitled “Method and Apparatus for State/Mode Transitioning,” and was issued on August 14, 2012. A true and correct copy of the ’683 patent is attached as Exhibit J.

58. The '683 patent was filed on November 13, 2008, as U.S. Patent Application No. 12/270,562, and claims priority to U.S. Provisional Patent Application Nos. 60/987,672 (filed on November 13, 2007), 61/061,359 (filed on June 13, 2008), 61/074,856 (filed on June 23, 2008), 61/086,955 (filed on August 7, 2008), and 61/089,731 (filed on August 18, 2008).

59. BlackBerry is the owner of all rights, title, and interest in and to the '683 patent, with the full and exclusive right to bring suit to enforce the '683 patent, including the right to recover for past infringement.

60. The '683 patent covers technology used in products that practice the UMTS/UTRAN Standards. Specifically, some or all claims of the '683 patent, including those claims specifically discussed below, are essential to implementations of the UMTS/UTRAN Standards that are set forth, *inter alia*, at least in the 3GPP TS 25.331 specification since at least Version 8.20.0 of the 3GPP TS 25.331 specification.

('829 Patent)

61. United States Patent No. 8, 644,829 (the "'683 patent") is entitled "Method and Apparatus for Signaling Release Cause Indication in a UMTS Network," and was issued on February 4, 2014. A true and correct copy of the '829 patent is attached as Exhibit K.

62. The '829 patent was filed on August 14, 2006, as U.S. Patent Application No. 11/464,380, and claims priority to U.S. Provisional Patent Application No. 60/747,466, which was filed on May 17, 2006.

63. BlackBerry is the owner of all rights, title, and interest in and to the '829 patent, with the full and exclusive right to bring suit to enforce the '829 patent, including the right to recover for past infringement.

64. The '829 patent covers technology used in products that practice the UMTS/UTRAN Standards. Specifically, some or all claims of the '829 patent, including those claims specifically discussed below, are essential to implementations of the UMTS/UTRAN Standards that are set forth, *inter alia*, at least in the 3GPP TS 25.331 specification since at least Version 8.24.0 of the 3GPP TS 25.331 specification.

(ETSI Declarations for the Asserted Patents)

65. The European Telecommunications Standards Institute (“ETSI”) is an industry organization that promulgates the wireless communication standards specified by 3GPP. BlackBerry, as well as Defendants Nokia Corporation and Nokia Solution and Networks Oy, are members of ETSI. BlackBerry and RIM have publicly declared to ETSI that the Asserted Patents may be or may become essential to LTE Standards and/or UMTS/UTRAN Standards, and those declarations are available to the public through an internet search engine provided and maintained by ETSI (<https://ipr.etsi.org/>). In particular, BlackBerry and RIM submitted the following declarations relevant to the Asserted Patents:

- BlackBerry declared to ETSI in August 2016 that the '418 patent, including its family members, may be or may become essential to practice the wireless communication standards specified by the 3GPP TS 36.321, 3GPP TS 36.211, and 3GPP TS 36.212 specifications.
- RIM declared to ETSI in February 2013 that the '246 patent, including its family members, may be or may become essential to practice the wireless communication standards specified by the 3GPP TS 36.211 and 3GPP TS 36.300 specifications.
- RIM declared to ETSI in June 2013 that the '090 patent, including its family members, may be or may become essential to practice the wireless communication

standards specified by the 3GPP TS 36.211, 3GPP TS 36.212, and 3GPP TS 36.300 specifications.

- BlackBerry declared to ETSI in August 2015 that the '305 patent, including its family members, may be or may become essential to practice the wireless communication standards specified by the 3GPP TS 36.211 specification.
- BlackBerry declared to ETSI in November 2014 that the '433 patent, including its family members, may be or may become essential to practice the wireless communication standards specified by the 3GPP TS 23.272, 3GPP TS 24.301, and 3GPP TS 25.331 specifications.
- BlackBerry declared to ETSI in August 2016 that the '697 patent, including its family members, may be or may become essential to practice the wireless communication standards specified by the 3GPP TS 23.221, 3GPP TS 23.272, 3GPP TS 24.008, 3GPP TS 24.301, 3GPP TS 25.331, 3GPP TS 36.300, 3GPP TS 36.304, and 3GPP TS 36.331 specifications.
- BlackBerry declared to ETSI in November 2014 that the '772 patent's parent patent, including its family members and therefore the '772 patent, may be or may become essential to practice the wireless communication standards specified by the 3GPP TS 36.213 and 3GPP TS 36.331 specifications.
- RIM declared to ETSI in February 2012 that '192 patent's grandparent patent, including its family members and therefore the '192 patent, may be or may become essential to practice the wireless communication standards specified by the 3GPP TS 36.211, 3GPP TS 36.321, 3GPP TS 36.322, and 3GPP TS 36.331 specifications.
- BlackBerry declared to ETSI in August 2015 that the '202 patent, including its family

members, may be or may become essential to practice the wireless communication standards specified by the 3GPP TS 36.201, 3GPP TS 36.211, 3GPP TS 36.212, 3GPP TS 36.213, and 3GPP TS 36.300 specifications.

- RIM declared to ETSI in March 2012 that the '683 patent, including its family members, may be or may become essential to practice the wireless communication standards specified by the 3GPP TS 25.331 specification.
- RIM declared to ETSI in April 2010 that the '829 patent, including its family members, may be or may become essential to practice the wireless communication standards specified by the 3GPP TS 25.331 and 3GPP TS 24.008 specifications.

NOKIA'S INFRINGING PRODUCTS

66. On information and belief, LTE and UMTS/UTRAN Standards that include those set forth at least in the 3GPP TS 23.221, 3GPP TS 23.272, 3GPP TS 24.008, 3GPP TS 24.301, 3GPP TS 25.331, 3GPP TS 36.201, 3GPP TS 36.211, 3GPP TS 36.212, 3GPP TS 36.213, 3GPP TS 36.300, 3GPP TS 36.304, 3GPP TS 36.321, 3GPP TS 36.322, and 3GPP TS 36.331 specifications (the "3GPP Specifications") are implemented and have been implemented in Nokia's LTE- and UMTS/UTRAN-compliant mobile network products and services, such as Nokia's Flexi line of products, alone or in combination with associated Nokia software such as the Nokia Liquid Radio Software Suite (collectively, the "Infringing Products"). The Infringing Products include, without limitation, the following products, alone or in combination: Nokia's Flexi Multiradio and Multiradio 10 base stations (including Flexi RFM 3-pipe 240 W, Flexi RRH 2-pipe 120 W, Flexi RRH 4-pipe 120 W, and Flexi RFM 6-pipe 360 W products), the Flexi Zone (small cell) Micro and Pico base stations, Femtocell base stations, Flexi Network Server, the Flexi Radio Antenna System, AirScale Active Antennas, Nokia radio network controllers

(including the Multicontroller RNC, Airscale RNC, 9730 RNC, and Wireless Cloud Element RNC), and Nokia Liquid Radio Software Suite. These products are not generally available for sale to the public and are therefore not available for purchase by a company such as BlackBerry in a manner that would allow direct comparison of the claims of the Asserted Patents to the structure and operation of the Infringing Products.

67. On information and belief, Nokia sells and offers for sale products and services in the United States that implement LTE and UMTS/UTRAN Standards, including those set forth at least in the 3GPP Specifications, and thereby directly infringes at least the claims of the Asserted Patents that are identified below, which cover features of the LTE and UMTS/UTRAN Standards. These products include the Infringing Products. On information and belief, Nokia Corporation encourages and instructs Nokia Solutions and Networks Oy and Nokia Solutions and Networks US to sell, offer for sale, make, and use products and services in the United States that implement LTE and UMTS/UTRAN Standards, including those set forth at least in the 3GPP Specifications, and thereby encourages and instructs them to directly infringe at least the claims of the Asserted Patents that are identified below, which cover features of the LTE and UMTS/UTRAN Standards. These products include the Infringing Products. On information and belief, Nokia Solutions and Networks Oy encourages and instructs Nokia Solutions and Networks US to sell, offer for sale, make, and use products and services in the United States that implement LTE and UMTS/UTRAN Standards, including those set forth at least in the 3GPP Specifications, and thereby encourages and instructs Nokia Solutions and Networks US to directly infringe at least the claims of the Asserted Patents that are identified below. These products include the Infringing Products.

68. On information and belief, the Infringing Products are an important part of Nokia's LTE and UMTS/UTRAN mobile network product and services offering in the United States. The Infringing Products are sold in the United States, where they have been purchased and deployed by customers. On information and belief, customers such as mobile service providers in the United States use the Infringing Products in the manner Nokia intends such Infringing Products to be used. Such mobile service providers include, but are not limited to, T-Mobile and AT&T.

69. On information and belief, Nokia encourages and instructs customers and potential customers in the United States, including but not limited to mobile service providers such as T-Mobile and AT&T, to purchase, deploy, and use Infringing Products to develop and operate their LTE networks and UMTS networks/UTRANs and thereby practice (i.e., directly infringe) at least the claims of the Asserted Patents that are identified below, which cover features of the LTE and UMTS/UTRAN Standards. On information and belief, Nokia has deployed and optimized, and supports, one or more of its customers' mobile networks in the United States that use the Infringing Products, wherein the use of such mobile networks directly infringes at least the claims of the Asserted Patents that are identified below, which cover features of the LTE and UMTS/UTRAN Standards.

70. On information and belief, Nokia imports mobile network products into the United States that implement LTE and UMTS/UTRAN Standards, including those set forth at least in the 3GPP Specifications, and thereby directly infringes at least the claims of the Asserted Patents that are identified below, which cover features of the LTE and UMTS/UTRAN Standards. On information and belief, these products include the Infringing Products.

71. On information and belief, Nokia researches, develops, and tests in the United States products and services that implement LTE and UMTS/UTRAN Standards, including those set forth at least in the 3GPP Specifications, and thereby directly infringes at least the claims of the Asserted Patents that are identified below, which cover features of the LTE and UMTS/UTRAN Standards. These products and services include the Infringing Products, which Nokia uses within the United States.

NOKIA'S KNOWLEDGE OF ITS INFRINGEMENT OF THE ASSERTED PATENTS

72. Nokia has known that the making, use, offer for sale, and sale within the United States, and importation into the United States, of its Infringing Products infringe the Asserted Patents since at least when it received notice by letter (attached hereto as Exhibit L) on February 14, 2017, from BlackBerry of such infringement prior to the filing of the original complaint in this suit and as a result of BlackBerry filing and serving the original complaint in this action on February 14, 2017 (ECF Nos. 1, 5, 6). (By stipulation and order, service of the original complaint in this action on Nokia Corporation and Nokia Solutions and Networks Oy took place February 28, 2017 (ECF No. 8), although on information and belief, Nokia Corporation and Nokia Solutions and Networks Oy knew of the Asserted Patents and their infringement based on the Infringing Products on or before about February 14, 2017, and certainly by February 28, 2017.)

73. Nokia has known that its products and services, including the Infringing Products, that use the LTE and UMTS/UTRAN Standards, including those set forth in the 3GPP Specifications, are covered by the Asserted Patents since at the latest February 2017, as set forth at least in the original complaint in this action (ECF No. 1). Nokia had knowledge at the latest as of February 2017 that its customers' use of the Infringing Products in the United States in accordance with the LTE and UMTS/UTRAN Standards infringes the Asserted Patents, as set

forth at least in the original complaint in this action (ECF No. 1). Nokia's continued encouragement and instructions to customers in the United States, including but not limited to mobile service providers, since at latest February 2017, to purchase, deploy, and use Infringing Products to develop and operate their LTE networks and UMTS networks/UTRANs had the specific intent to cause ongoing direct infringement of the Asserted Patents by such customers' use of the Infringing Products in accordance with the LTE and UMTS/UTRAN Standards, as set forth at least in the original complaint in this action (ECF No. 1).

NOKIA BECAME AWARE OF APPLICATIONS FOR OR FAMILY MEMBERS OF THE ASSERTED PATENTS DURING PROSECUTIONS OF ITS OWN PATENTS

74. Family members of the '246 patent were cited in an international search report and cited by Nokia and by an examiner during prosecution of a number of patent applications assigned to Nokia. The '246 patent is a continuation of U.S. Patent Application No. 11/819,690, which is a continuation of U.S. Patent Application No. 10/038,883 (the "'883 application"), which was published as U.S. Patent Application Publication No. 2003/0072254 A1 (the "'254 publication") and issued as U.S. Patent No. 7,248,559 (the "'559 patent"). The '254 publication and the '559 patent were both cited by the examiner on November 10, 2009, during prosecution of a Nokia U.S. Patent Application No. 10/574,350.

75. Moreover, the '883 application claims priority to U.S. Provisional Patent Application No. 60/329,509. WIPO International Patent Application Publication No. WO2003034644 (the "'644 publication") also claims priority to U.S. Provisional Patent Application No. 60/329,509 and to the '883 application. The '644 publication was cited by Nokia in an information disclosure statement ("IDS") filed on July 26, 2005, during prosecution of Nokia U.S. Patent Application No. 10/783,129, which was issued on August 12, 2008, as U.S. Patent No. 7,412,005. Regarding Nokia PCT International Patent Application

No. PCT/IB2005/000348, which was filed on February 11, 2005, and claims priority to Nokia U.S. Patent Application No. 10/783,129, the '644 publication was cited in the June 23, 2005 international search report as a document of particular relevance. (The international search report also identifies the related '254 publication.) The June 23, 2005 written opinion of the international searching authority used the '644 publication, which is labeled therein as the D3 reference, to attack the novelty of five of the patent claims filed by Nokia.

76. Nokia had actual notice of family members of the '246 patent cited in the international search report and cited by Nokia and by the examiner during the prosecution of Nokia's patent applications cited above as of the dates on which each of these references was cited, and no later than the dates that any of these Nokia applications were issued as patents. On information and belief, based on Nokia's notice of these family members of the '246 patent, Nokia had notice of the '246 patent long before the filing of this action.

77. The publication of the parent application of the '090 patent was cited in an international search report and cited by Nokia during prosecution of a number of patent applications assigned to Nokia. The '090 patent is a continuation of U.S. Patent Application No. 12/221,867, which was issued as U.S. Patent No. 8,290,088, and which was published as U.S. Patent Application Publication No. 2009/0060088 (the "'088 publication"). The '088 publication was cited during prosecution of a number of Nokia patent applications, including:

- U.S. Patent Application No. 11/969,794, issued March 13, 2012, as U.S. Patent No. 8,135,359 (the '088 publication was cited by Nokia in a September 16, 2009 IDS);
- U.S. Patent Application No. 13/461,337, issued as U.S. Patent No. RE44,649 as a reissue of certain claims of U.S. Patent No. 8,135,359 (the '088 publication was cited by Nokia in a May 18, 2012 IDS);

- U.S. Patent Application No. 12/866,236, which was issued on September 9, 2014, as U.S. Patent No. 8,831,542 (the '088 publication was cited by Nokia in an August 4, 2010 IDS);
- U.S. Patent Application No. 14/474,700, which was issued on November 24, 2015, as U.S. Patent No. 9,197,304 (the '088 publication was cited by Nokia in a November 17, 2014 IDS); and
- Internal Search Reports for PCT/IB2008/03554 and PCT/IB2009/050044.

78. Nokia had actual notice of the '088 publication as of the dates on which it was cited in an international search report or cited by Nokia during the prosecutions of Nokia's patent applications discussed above, and no later than the dates any of these Nokia applications were issued as patents. On information and belief, based on Nokia's notice of this family member of the '090 patent, Nokia had notice of the '090 patent long before the filing of this action.

79. The publication of the parent application of the '772 patent was cited by examiners during prosecution of a number of patent applications assigned to Nokia. The '772 patent is a continuation of U.S. Patent Application No. 13/430,632, which was published as U.S. Patent Application Publication No. 2013/0010964 A1 (the "'964 publication"). The '964 publication was cited during prosecution of Nokia patent applications, including U.S. Patent Application No. 13/985,975, which was issued on November 15, 2016, as U.S. Patent No. 9,497,131, and U.S. Patent Application No. 13/996,194, which was filed December 22, 2010.

80. Nokia had actual notice of the '964 publication as of the dates on which it was cited by the examiners during the prosecutions of Nokia's patent applications discussed above, and no later than the dates that any of these Nokia applications were issued as patents. On

information and belief, based on Nokia's notice of this family member of the '772 patent, Nokia had notice of the '772 patent long before the filing of this action.

81. The publication of the parent application of the '192 patent was cited by the examiner during prosecution of at least one patent application that was assigned to Alcatel-Lucent, which was acquired by Nokia. The '192 patent is a continuation of U.S. Patent Application No. 13/287,731, which was published as U.S. Patent Application Publication No. 2012/0051226 A1 (the "'226 publication") and was issued as U.S. Patent No. 8,811,250. The '226 publication was cited during prosecution of Alcatel-Lucent's U.S. Patent Application No. 13/617,423, which was issued on February 24, 2015, as U.S. Patent No. 8,964,616.

82. Alcatel-Lucent had actual notice of the '226 publication as of the date on which it was cited by the examiner during the prosecution of U.S. Patent Application No. 13/617,423, and no later than the date that this Alcatel-Lucent application was issued as a patent. On information and belief, Nokia had actual notice of the '226 publication at least as a result of its acquisition of Alcatel-Lucent. On information and belief, based on Nokia's notice of this family member of the '192 patent, Nokia had notice of the '192 patent long before the filing of this action.

83. The publication of the priority application of the '202 patent was cited by the examiners during prosecution of a number of applications that were assigned to Alcatel entities, which were acquired by Nokia. The '202 patent is a continuation of U.S. Patent Application No. 13/620,514, which is a continuation of U.S. Patent Application No. 12/880,246, which is a division of U.S. Patent Application No. 10/385,792, which was published as U.S. Patent Application Publication No. 2004/0179544 A1 (the "'544 publication") and was issued as U.S. Patent No. 7,826,471. The '544 publication was cited during prosecution of Alcatel/Alcatel-Lucent patent applications, including U.S. Patent Application No. 11/106,627, which

was issued on February 22, 2011, as U.S. Patent No. 7,894,402, and U.S. Patent Application No. 13/377,640, which was issued on July 14, 2015, as U.S. Patent No. 9,083,398.

84. Alcatel/Alcatel-Lucent had actual notice of the '544 publication as of the dates on which it was cited by the examiners during the prosecutions of Alcatel's/Alcatel-Lucent's patent applications discussed above, and no later than the dates that these applications were issued as patents. On information and belief, Nokia had actual notice of the '544 publication at least as a result of its acquisition of Alcatel-Lucent. On information and belief, based on Nokia's notice of this family member of the '202 patent, Nokia had notice of the '202 patent long before the filing of this action.

85. Long before the filing of this action, Nokia knew or should have known from the prosecution of its own patent applications and those of Alcatel-Lucent that the asserted '246, '090, '772, '192, and '202 patents covered LTE features used by their Infringing Products.

86. The publication of the application that resulted in the issuance of the '683 patent was cited by the examiner during prosecution of a Nokia patent application. The '683 patent was filed as U.S. Patent Application No. 12/270,562, which was published as U.S. Patent Application Publication No. 2009/0124249 A1 (the "'249 publication"). The '249 publication was cited during prosecution of at least Nokia's U.S. Patent Application No. 13/822,865.

87. Nokia had actual notice of the U.S. patent application that resulted in the issuance of the '683 patent as of the date that Nokia received a March 9, 2015 Office Action during the prosecution of Nokia's U.S. Patent Application No. 13/822,865 in which the '249 publication was cited. On information and belief, based on Nokia's notice of the patent application that resulted in the issuance of the '683 patent, Nokia had knowledge of the '683 patent long before the filing of this action.

88. The publication of the application that resulted in the issuance of the '829 patent was cited by Nokia during prosecution of a Nokia patent application. The '829 patent was filed as U.S. Patent Application No. 11/464,380, which was published as U.S. Patent Application Publication No. 2007/0270140 A1 (the "'140 publication"). Nokia cited the '140 publication to the USPTO in an information disclosure statement filed on February 22, 2010, during the prosecution of Nokia's U.S. Patent Application No. 12/695,307, which was issued as U.S. Patent No. 8,391,223.

89. Nokia had actual notice of the U.S. patent application that resulted in the issuance of the '829 patent at the latest by February 22, 2010. On information and belief, based on Nokia's notice of the patent application that resulted in the issuance of the '829 patent, Nokia had knowledge of the '829 patent long before the filing of this action.

90. Long before the filing of this action, Nokia knew or should have known from the prosecution of its own patent applications that the asserted '683 and '829 patents covered UMTS/UTRAN features used by their Infringing Products.

**NOKIA'S KNOWLEDGE OF BLACKBERRY'S ASSERTED PATENTS
PREVIOUSLY OWNED BY NORTEL NETWORKS**

91. Nokia Siemens Networks ("NSN") was 50%-owned by Nokia Corporation prior to August 7, 2013, and became wholly owned by the Nokia Group and was renamed Nokia Networks and Solutions on or about August 7, 2013.

92. On information and belief, NSN had knowledge by June 19, 2009, and at the latest by July 24, 2009, of the LTE patents and patent applications owned by Nortel Networks Corporation (and its subsidiaries and affiliates) based on NSN's due diligence in connection with a June 19, 2009 "stalking horse" Asset Sale Agreement with Nortel Networks Corporation and certain other Nortel-related companies concerning the sale of substantially all of Nortel's CDMA

business and LTE Access assets and an Intellectual Property License Agreement that was associated with the asset sale agreement.

93. On information and belief, Nortel patents and patent applications that concerned, in whole or part, OFDM (Orthogonal Frequency-Division Multiplexing) and/or MIMO (Multiple Input, Multiple Output), which are technologies incorporated into the LTE Standards, were among the LTE assets that NSN sought to acquire through the Asset Sale Agreement and/or to license through the Intellectual Property License Agreement.

94. On information and belief, prior to or about the time of entering into the Asset Sale Agreement, NSN performed due diligence relating to, and gained knowledge of, the Nortel patents and patent applications that NSN sought to license under the Intellectual Property License Agreement and the Nortel patents and patent applications that NSN sought to acquire under the Asset Sale Agreement.

95. On information and belief, prior to or about the time of entering into the Asset Sale Agreement, NSN performed due diligence relating to, and gained knowledge of, Nortel's OFDM and MIMO patents in particular, which NSN sought to license under the Intellectual Property License Agreement or to acquire under the Asset Sale Agreement. On information and belief, NSN believed that if it closed the acquisition with Nortel, NSN would be in a position to use Nortel's patented OFDM and MIMO technologies in particular.

96. On information and belief, through this due diligence, NSN had knowledge by June 19, 2009, and at the latest by July 24, 2009, of the Nortel-owned '418 patent, which had been issued on February 7, 2006.

97. On information and belief, through this due diligence, NSN had knowledge by June 19, 2009, and at the latest by July 24, 2009, of the Nortel-owned parent and grandparent

patents to the '246 patent, U.S. Patent Nos. 7,545,734 (issued on June 9, 2009) and 7,248,559 (issued on July 24, 2007), respectively.

98. On information and belief, through this due diligence, NSN had knowledge by June 19, 2009, and at the latest by July 24, 2009, of Nortel-owned U.S. Patent Application No. 12/468,624 (the "'624 application"), which was filed on May 19, 2009, and which was later issued as the '246 patent.

99. On information and belief, NSN had knowledge of the '246 patent by or about its issue date of August 28, 2012, having been previously put on notice of U.S. Patent Nos. 7,248,559 and 7,545,734 and the '624 application.

100. On information and belief, through this due diligence, NSN had knowledge by June 19, 2009, and at the latest by July 24, 2009, of Nortel-owned U.S. Patent Application No. 12/221,867 ("the '867 application"), which was filed on August 7, 2008, and which was published as U.S. Patent Application Publication No. 2009/00060088 A1 ("the '088 publication") on March 5, 2009. The application that resulted in the issuance of the '090 patent, U.S. Patent Application No. 13/608,184, is a continuation of the '867 application.

101. On information and belief, NSN had knowledge of the '090 patent by or about its issue date of July 23, 2013, having been previously put on notice of the '867 application and the '088 publication.

102. On information and belief, through this due diligence, NSN had knowledge by June 19, 2009, and at the latest by July 24, 2009, of the Nortel-owned '305 patent, which had been issued on May 5, 2009.

103. On information and belief, through this due diligence, NSN had knowledge by June 19, 2009, and at the latest by July 24, 2009, of Nortel-owned U.S. Patent Application

No. 10/385,792 (“the ’792 application”), which was filed on March 11, 2003, and which was published as U.S. Patent Application Publication No. 2004/0179544 A1 (“the ’544 publication”) on September 16, 2004. The application that resulted in the issuance of the ’202 patent, U.S. Patent Application No. 14/257,424, is a continuation of a continuation of a division of the ’792 application.

104. On information and belief, NSN had knowledge of the ’202 patent by or about its issue date of September 1, 2015, having been previously put on notice of the ’792 application and the ’544 publication.

105. NSN lost the bidding process for Nortel’s CDMA business and LTE Access assets to Telefonaktiebolaget LM Ericsson on or about July 24, 2009.

106. On information and belief, as of July 24, 2009, and thereafter, NSN and its successor company, subsidiaries, parent, and affiliates (i.e., Nokia) understood that certain LTE technologies, including OFDM and MIMO technologies, were covered by the claims in the Nortel U.S. patents (and their later-issued U.S. family members) that NSN had sought to license under the Intellectual Property License Agreement and that NSN had sought to acquire under the Asset Sale Agreement. On information and belief, as of July 24, 2009, and thereafter, NSN and its successor company, subsidiaries, parent, and affiliates (i.e., Nokia) also understood that they could not use the patented LTE technologies from those Nortel U.S. patents, in particular the OFDM and/or MIMO patents, in their mobile infrastructure products and services in the United States without infringing those patents, including the ’418, ’246, ’090, ’305, and ’202 patents.

107. In connection with Nortel’s U.S. bankruptcy proceedings in 2011, Nortel sought the bankruptcy court’s permission to sell residual patent assets, including LTE patents and in particular OFDM and MIMO patents (including the patent families associated with the

'418, '246, '090, '305, and '202 patents), to a stalking horse purchaser that was an affiliate of Google, Inc., to serve as a basis for conducting an auction for these assets.

108. On June 13, 2011, Nokia Corporation objected to what Nokia styled as Nortel's "Sale Motion" for these residual patent assets to the extent Nortel sought to sell the patent assets free and clear of standard setting organization ("SSO") commitments that were not expressly identified in the Sale Motion. *See* Nokia Corp.'s Objection to Sale Free and Clear of Debtors' SSO Commitments, *In re Nortel Networks Inc.*, No. 09-10138-KG (Bankr. D. Del. June 13, 2011), ECF No. 5665. Nokia stated that it was aware that Nortel entities had made SSO commitments to, among others, the Third Generation Partnership Project through ETSI, related to LTE standards. Nokia also stated that Nortel had declared many of its patents as essential to industry standards, and that Nokia and other industry members have relied on and will continue to rely on these SSO commitments.

109. By April 10, 2012, RIM had acquired the '418, '246, and '305 patents and had caused to be recorded at the USPTO the assignments of ownership of these patents to RIM. By March 2, 2013, RIM/BlackBerry had acquired the patent application that was issued as the '090 patent, U.S. Patent Application No. 13/608,184, and had caused to be recorded at the USPTO the assignment of ownership of this application to RIM. By October 16, 2014, RIM/BlackBerry had acquired the application that issued as the '202 patent, U.S. Patent Application No. 14/257,424, and had caused to be recorded at the USPTO the assignment of ownership of this application to RIM. Currently the assignment of the '418, '246, '305, '090, and '202 patents to BlackBerry are all recorded at the USPTO.

**FIRST CLAIM FOR RELIEF
(INFRINGEMENT OF UNITED STATES PATENT NO. 6,996,418)**

110. BlackBerry realleges and incorporates by reference the allegations of paragraphs 1-109 of this Amended Complaint.

The '418 Patent

111. The '418 patent, among other things, is directed to an Orthogonal Frequency Division Multiplexed (OFDM) base transceiver station (BTS) arranged to communicate with mobile terminals within a coverage area including at least one target mobile terminal, the BTS including a processing apparatus that receives and processes service and data traffic information and a transmission apparatus that receives the processed service and data traffic information, to transmit the processed service information on a first set of carriers to the mobile terminals within the coverage area with at least one first transmission beam and to transmit the processed data traffic information on a second set of carriers to the target mobile terminal on at least one second transmission beam, the second transmission beam being a directional transmission beam.

(*See* Exhibit A, '418 patent, Claim 1.)

112. The '418 patent explains that, in an OFDM system, there is a need for pilot information (*e.g.*, frequency reference, carrier recovery, and channel estimates) and signaling messages (*e.g.*, control messages) to be consistently transmitted to all mobile terminals in a particular coverage area. (*See id.* at 1:37-39.) At the time of the invention of the '418 patent, a well-known implementation used the same antenna beam to transmit the pilot, signaling, and data traffic channels for a given radio frequency channel to an entire coverage area from the base transceiver station (BTS). (*Id.* at 1:39-44.)

113. The problem with this implementation was “the limited power (or link gain) that a sector of omni-directional broadcast is capable of while reaching all of the mobile terminals

within the coverage area simultaneously.” (*Id.* at 1:60-63.) As bit rates increase, the use of a sector omni-directional broadcast to transmit the data traffic “would be relatively expensive and possibly impractical,” and increase the “possibility of interference into adjacent cells or sectors.” (*Id.* at 1:63-2:6.)

114. The '418 patent provides an apparatus and method wherein “[t]he beam transmitting the data traffic information is a directional beam.” This helps “to ensure sufficient power is directed at the target mobile terminal(s) while the beam transmitting the service information can . . . be a sector omni-directional beam.” (*Id.* at 2:33-37.)

115. Figure 5 of the '418 patent (reproduced below) shows an exemplary radio system “with a directional data traffic beam and a sector omni-directional service beam.” (*Id.* at 4:63-65.) The directional beam is “utilized as the data traffic beam in order for the BTS 50 to transmit the data traffic with sufficient link gain to the target mobile terminal 54 while a sector omni-directional beam 89 is utilized as the service beam in order for the BTS 50 to transmit the pilot and signalling channels continually to all of the mobile terminals in its coverage area.” (*Id.* at 10:42-48.)

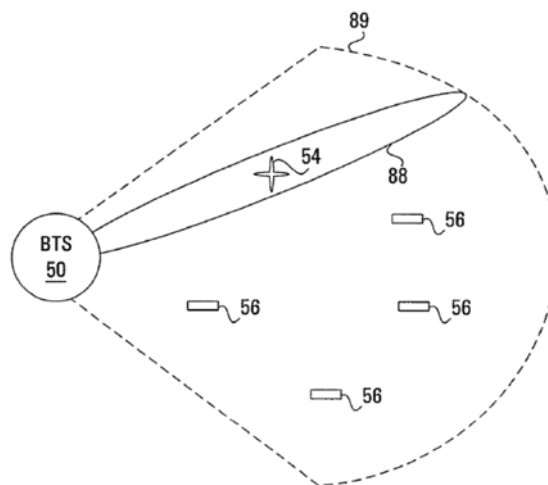

FIG. 5

'418 Patent Allegations

116. Nokia has infringed and is infringing, either literally or under the doctrine of equivalents, at least Claims 1, 2, 4, and 5 of the '418 patent in violation of 35 U.S.C. § 271 *et seq.*, directly and/or indirectly, by making, using, offering for sale/lease, and/or selling or leasing in the United States, and/or importing into the United States, without authority or license, the Infringing Products.

117. On information and belief, by complying with LTE Standards, including those set forth in the 3GPP TS 36.300, 3GPP TS 36.321, 3GPP TS 36.211, 3GPP TS 36.212, and 3GPP TS 36.213 specifications, the Infringing Products and their use are covered by at least Claims 1, 2, 4, and 5 of the '418 patent. The Infringing Products use one or more LTE transmission modes in which mobile stations in a narrow coverage area receive the data traffic via a directional transmission beam, while all mobile stations in the coverage area receive the service information via another transmission beam, including at least, *inter alia*, LTE Transmission Mode 4.

118. Nokia has been, and currently is, an active inducer of infringement of the '418 patent under 35 U.S.C. § 271(b), and a contributory infringer of the '418 patent under 35 U.S.C. § 271(c).

119. On information and belief, the Infringing Products include hardware and/or software configured to perform or embody patented limitations of the '418 patent. For example, the Infringing Products include hardware and/or software configured to transmit processed service information on a first set of carriers to mobile terminals and to transmit processed data traffic information on a second set of carriers to a target mobile terminal on a directional

transmission beam. On information and belief, the portion of the hardware and/or software that performs or embodies the patented limitations has no substantial non-infringing uses.

120. Nokia knew of the '418 patent, or should have known of the '418 patent but was willfully blind to its existence. Nokia knew of the '418 patent and was put on notice of its infringement through a notice letter sent from BlackBerry prior to the filing of the original complaint in this action on February 14, 2017, and as a result of BlackBerry filing and serving the original complaint in this action (ECF Nos. 1, 5, 6, 8). On information and belief, Nokia had actual knowledge of the '418 patent since at least as early as June 19, 2009, and at the latest by July 24, 2009. On information and belief, Nokia developed, commercialized, demonstrated, and/or tested the Infringing Products despite its evaluation and knowledge of the Nortel patent portfolio, including the '418 patent. Nokia has taken action intending to cause others to directly infringe the '418 patent, including by selling or offering for sale the Infringing Products to third parties in the United States while expressly promoting these products' capability to practice the LTE Standards, knowing that using these products to practice the LTE Standards (including Transmission Mode 4 in the manner described above) would constitute direct infringement of the '418 patent. Therefore, on information and belief, Nokia knew or should have known of the '418 patent and of its own infringing acts, or deliberately took steps to avoid learning of those facts.

121. Nokia knowingly and intentionally encourages and aids at least its end-user customers to directly infringe the '418 patent. Nokia's end-user customers directly infringe at least Claims 1, 2, 4, and 5 of the '418 patent by using the Infringing Products in their intended manner (including use of Transmission Mode 4 in the manner described above) to infringe. Nokia induces such infringement by providing the Infringing Products and services, instructions,

and technical support to enable and facilitate infringement (including by use of Transmission Mode 4 in the manner described above), knowing of, or being willfully blind to the existence of, the '418 patent. On information and belief, Nokia specifically intends that its actions will result in infringement of at least Claims 1, 2, 4, and 5 of the '418 patent, or subjectively believes that its actions will result in infringement of the '418 patent but took deliberate actions to avoid learning of those facts, as set forth above. Nokia has persisted in encouraging the use of the LTE-compliant Infringing Products by its customers in a manner that infringes at least Claims 1, 2, 4, and 5 of the '418 patent (including by use of Transmission Mode 4 in the manner described above), without a license from BlackBerry.

122. Nokia contributorily infringes at least Claims 1, 2, 4, and 5 of the '418 patent by providing to its customers the Infringing Products and/or software or hardware components thereof, that perform or embody a material part of the claimed inventions of the '418 patent, that are known by Nokia to be specially made or adapted for use in an infringing manner, and are not staple articles, nor have substantial non-infringing uses. In particular, on information and belief, because the patented limitations cover features of the LTE Standards that have been widely-used in practice (including Transmission Mode 4 in the manner described above), the portion of the hardware and/or software of the Infringing Products that performs or embodies the patented limitations of at least Claims 1, 2, 4, and 5 cannot feasibly be removed or disabled. Nokia has known its customers infringe at least Claims 1, 2, 4, and 5 by using the Infringing Products and/or software or hardware components thereof to practice these claims at latest as a result of BlackBerry filing and serving the original complaint in this action (ECF Nos. 1, 5, 6, 8).

123. Nokia Corporation knowingly and intentionally encourages and aids at least subsidiaries Nokia Solutions and Networks Oy and Nokia Solutions and Networks US to directly

infringe the '418 patent. Nokia Solutions and Networks Oy knowingly and intentionally encourages and aids at least subsidiaries Nokia Solutions and Networks US to directly infringe the '418 patent. Nokia Solutions and Networks Oy and Nokia Solutions and Networks US directly infringe at least Claims 1, 2, 4, and 5 of the '418 patent at least by offering for sale, selling, making, and using the Infringing Products in the United States (including those incorporating use of Transmission Mode 4 in the manner described above). Nokia Corporation and Nokia Solutions and Networks Oy induce such direct infringement by encouraging, aiding, technically supporting, and instructing their subsidiaries to sell, offer for sale, make, and use the Infringing Products in the United States (including those incorporating use of Transmission Mode 4 in the manner described above). Nokia Corporation and Nokia Solutions and Networks Oy further induce such direct infringement by encouraging, aiding, technically supporting, and instructing their subsidiaries to design the Infringing Products so that they comply with the LTE standards (including Transmission Mode 4 described above) in a manner that infringes at least Claims 1, 2, 4, and 5 of the '418 patent. On information and belief, Nokia Corporation and Nokia Solutions and Networks Oy specifically intend that their actions will result in infringement of at least Claims 1, 2, 4, and 5 of the '418 patent, or subjectively believes that their actions will result in infringement of the '418 patent but took deliberate actions to avoid learning of those facts, as set forth above. Nokia Corporation and Nokia Solutions and Networks Oy have persisted in encouraging the offer for sale, sale, making, and use of the LTE-compliant Infringing Products by their subsidiaries in a manner that infringes at least Claims 1, 2, 4, and 5 of the '418 patent (including by incorporating use of Transmission Mode 4 in the manner described above), without a license from BlackBerry.

124. Nokia Corporation and Nokia Solutions and Networks Oy contributorily infringe at least Claims 1, 2, 4, and 5 of the '418 patent by providing, respectively, to subsidiaries Nokia Solutions and Networks Oy and Nokia Solutions and Networks US and to subsidiaries Nokia Solutions and Networks US the Infringing Products, and/or software or hardware components thereof, that perform or embody a material part of the claimed inventions of the '418 patent, that are known by Nokia Corporation and Nokia Solutions and Networks Oy to be specially made or adapted for use in an infringing manner (including by using Transmission Mode 4 in the manner described above), and are not staple articles, nor have substantial non-infringing uses. In particular, on information and belief, because the patented limitations cover features of the LTE Standards that have been widely-used in practice (including Transmission Mode 4 in the manner described above), the portion of the hardware and/or software of the Infringing Products that performs or embodies the patented limitations of at least Claims 1, 2, 4, and 5 cannot feasibly be removed or disabled. Nokia Corporation and Nokia Solutions and Networks Oy have known their subsidiaries infringe at least Claims 1, 2, 4, and 5 by offering for sale, selling, making, and using the Infringing Products and/or software or hardware components thereof to practice these claims at latest as a result of BlackBerry filing and serving the original complaint in this action (ECF Nos. 1, 5, 6, 8).

125. Nokia's infringement has been, and continues to be, willful and deliberate, and has caused substantial damage to BlackBerry. In spite of Nokia's knowledge of the '418 patent, Nokia has continued making, using, offering for sale/lease, and/or selling or leasing in the United States, and/or importing into the United States, the Infringing Products that are compliant with the LTE Standards (including Transmission Mode 4 as described above), without a license from BlackBerry. In spite of Nokia's knowledge of the '418 patent, Nokia has continued its conduct

constituting induced infringement and contributory infringement of that patent. In committing acts of direct and indirect infringement, Nokia has committed egregious misconduct including, for example, acting despite knowing that its actions constituted infringement of the valid '418 patent, or recklessly disregarding the fact that its actions constituted an unjustifiably high risk of infringement of the valid and enforceable '418 patent. Nokia's willful and deliberate infringement warrants an award of enhanced damages.

**SECOND CLAIM FOR RELIEF
(INFRINGEMENT OF UNITED STATES PATENT NO. 8,254,246)**

126. BlackBerry realleges and incorporates by reference the allegations of paragraphs 1-125 of this Amended Complaint.

The '246 Patent

127. The '246 patent is directed to, among other things, methods for “inserting pilot symbols into Orthogonal Frequency Division Multiplexing (OFDM) frames at an OFDM base station having a plurality of transmitting antennas,” with “an adjacent OFDM base station having a plurality of transmitting antennas,” and “for each antenna, inserting scattered pilot symbols in an identical scattered pattern in time-frequency, wherein the scattered patterns are offset from the adjacent OFDM base station.” (Exhibit B, '246 patent, Claim 1.) The '246 patent also discloses an OFDM base station comprising “an OFDM frame generator that inserts pilot symbols into OFDM frames . . . wherein for each antenna, scattered pilot symbols are inserted in an identical scattered pattern in time-frequency, wherein the scattered patterns are offset from the adjacent OFDM base station.” (*Id.*, Claim 15.)

128. The '246 patent explains that wireless communications systems that employ OFDM can “transmit[] data to a receiver using many sub-carriers in parallel,” and the “frequencies of the sub-carriers are orthogonal.” (*Id.* at 1:28-31.) Data is “encoded, interleaved,

and modulated to form data symbols,” “[o]verhead information is added, including pilot symbols,” and the “symbols [] are organized into OFDM symbols.” (*Id.* at 1:37-39.)

129. The '246 patent explains that the “inclusion of pilot symbols in each OFDM symbol allows the receiver to carry out channel estimation,” which is the determination of “variations in phase and amplitude resulting from propagation along the channel” (also referred to as the “channel response”). (*Id.* at 2:5-13.) The receiver “compares the received value of the pilot symbols with the known transmitted value of the pilot symbols to estimate the channel response.” (*Id.* at 2:14-17.) “Since the channel response can vary with time and with frequency, the pilot symbols are scattered amongst the data symbols to provide as complete a range as possible of channel response over time and frequency.” (*Id.* at 2:20-23.) The “pilot pattern” is the “set of frequencies and times at which pilot symbols are inserted.” (*Id.* at 2:23-25.) As overhead, the pilot symbols “should be as few in number as possible in order to maximize the transmission rate of data symbols.” (*Id.* at 2:18-20.)

130. At the time of the invention of the '246 patent, “existing pilot-assisted OFDM channel estimation approaches [were] designed for conventional one transmitter systems.” (*Id.* at 2:30-32.) Existing pilot patterns were “usually sufficient if the channel varies slowly with time,” but not “if the channel varies quickly with time (for example, for mobile applications).” (*Id.* at 3:41-45.) In the latter situation, “the time interval between pilot symbols must be reduced in order to allow an accurate estimation of the channel response through interpolation,” which increases the overhead signal. (*Id.* at 3:43-47.) The “problem of minimizing the number of pilot symbols while maximizing the accuracy of the interpolation” was also particularly cumbersome in Multiple-Input Multiple-Output (MIMO) OFDM systems in which “the transmitter transmits

data through more than one transmitting antenna and the receiver receives data through more than one receiving antenna.” (*Id.* at 3:48-55.)

131. The '246 patent provides methods that “allow fewer pilot symbols to be placed within each OFDM symbol, while still allowing accurate interpolation of the channel response,” and the “data rate of an MIMO-OFDM system is thereby improved.” (*Id.* at 4:23-26.) The '246 patent also discloses providing a transmitter that implements the methods.

132. Figure 5 (below) shows an exemplary pilot pattern generated using the method disclosed in the '246 patent. In this figure, pilot and data symbols are illustrated by the circles across the OFDM frame in a time direction and a frequency direction. (*Id.* at 9:54-57.) The figure shows a “first set of encoded pilot symbols 126 corresponding to the first transmitting antenna 37” and a “second set of encoded pilot symbols 128 corresponding to the first transmitting antenna 37,” inserted in “a diamond lattice structure at the same frequencies,” but “offset by one OFDM symbol location in the time direction 120.” (*Id.* at 9:58-65.) In a “multiple base station transmission arrangement, the location of the diamond lattice pattern can be cyclic offset both in time direction and in frequency direction amongst adjacent base stations to form a diamond lattice re-use pattern.” (*Id.* at 10:13-17.)

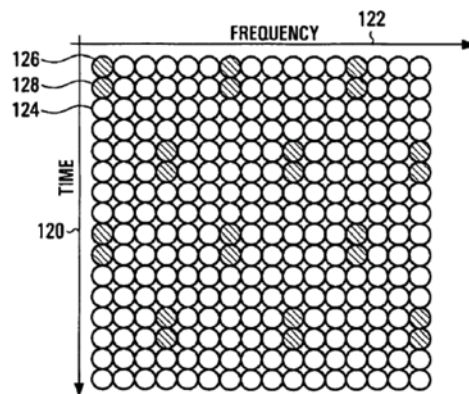

FIG. 5

'246 Patent Allegations

133. Nokia has infringed and is infringing, either literally or under the doctrine of equivalents, at least Claims 1, 3, 8-10, 15, 17, 22, and 23 of the '246 patent in violation of 35 U.S.C. § 271 *et seq.*, directly and/or indirectly, by making, using, offering for sale/lease, and/or selling or leasing in the United States, and/or importing into the United States, without authority or license, the Infringing Products.

134. By complying with LTE Standards, including those set forth in the 3GPP TS 36.211 and 3GPP TS 36.300 specifications, the Infringing Products including or coupled to transmit antennas for use in an LTE network, and/or their use, are covered by at least Claims 1, 3, 8-10, 15, 17, 22, and 23 of the '246 patent. Infringing Products are sold with and/or associated with two or more transmit antennas to implement LTE-compliant systems with two or more downlink antennas.

135. On information and belief after reasonable investigation, the Infringing Products including or coupled to transmit antennas for use in an LTE network are covered by exemplary Claim 1. Version 8.9.0 and subsequent versions of the 3GPP TS 36.211 specification describe the physical channels of the Evolved Universal Terrestrial Radio Access Network (E-UTRAN), which is commonly known as the LTE radio access network. The Infringing Products that are compliant with the LTE Standards implement the physical channels set forth in at least Version 8.9.0 and subsequent versions of the 3GPP TS 36.211 specification. Section 6 of the 3GPP TS 36.211 V8.9.0 specification, in particular, describes the downlink physical channels from a base station to user equipment (e.g., a mobile device) that is relevant to Claim 1 of the '246 patent.

136. The pilot signals of the '246 patent are referred to as "reference signals" in the 3GPP TS 36.211 specification. They are inserted into an OFDM frame in the LTE-compliant

Infringing Products, for example, as specified in Sections 6.2 and 6.10.1 of the 3GPP TS 36.211 V8.9.0 specification and subsequent versions. The OFDM frames of Sections 6.2 and 6.10 of the 3GPP TS 36.211 specification have a time domain and a frequency domain.

137. The Infringing Products are configured, and sold to be configured, into an overall E-UTRAN architecture with two or more base stations, designated eNBs as depicted below in Figure 4-1 of Section 4 of the 3GPP TS 36.300 specification:

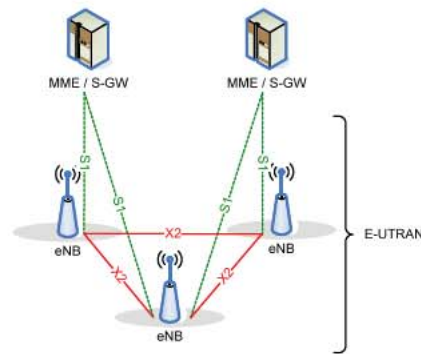

Figure 4-1: Overall [LTE] Architecture

138. The identical scattered patterns of pilot symbols for the base station and adjacent base station of Claim 1 of the '246 patent, as well as frequency and/or temporal offset, that are implemented in the Infringing Products are set forth, *inter alia*, in Section 6.10.1 of the 3GPP TS 36.211 V8.9.0 specification and subsequent versions. Infringing patterns of pilot symbols are depicted for what is called the “normal cyclic prefix” in Figure 6.10.1.2-1 of the 3GPP TS 36.211 V8.9.0 specification:

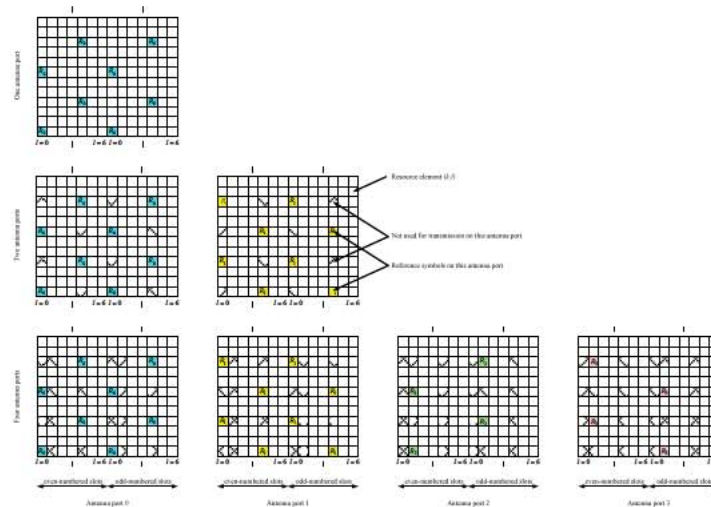

Figure 6.10.1.2-1. Mapping of downlink reference signals (normal cyclic prefix).

Accordingly, the making, use, offer for sale, or sale within the United States, or importation into the United States, of the Infringing Products including or coupled to transmit antennas for use in an LTE network infringes at least Claim 1.

139. Nokia has been, and currently is, an active inducer of infringement of the '246 patent under 35 U.S.C. § 271(b) and a contributory infringer of the '246 patent under 35 U.S.C. § 271(c).

140. On information and belief, the Infringing Products implement hardware and/or software configured to perform or embody the patented limitations of at least Claims 1, 3, 8-10, 15, 17, 22, and 23 of the '246 patent. For example, the Infringing Products contain hardware and/or software designed to insert into OFDM frames scattered pilot symbols in an identical scattered pattern in time-frequency, wherein the scattered patterns are offset from those in an adjacent OFDM base station. On information and belief, the portion of the hardware and/or software that performs or embodies the patented limitations has no substantial non-infringing uses. In particular, because the patented limitations cover mandatory features of the LTE Standards (including features set forth in the 3GPP TS 36.211 and 3GPP TS 36.300

specifications), the portion of the hardware and/or software of the Infringing Products that performs or embodies the patented limitations cannot feasibly be removed or disabled.

141. Nokia knew of the '246 patent, or should have known of the '246 patent but was willfully blind to its existence. Nokia knew of the '246 patent and was put on notice of its infringement through a notice letter sent from BlackBerry prior to the filing of the original complaint in this action on February 14, 2017, and as a result of BlackBerry filing and serving the original complaint in this action (ECF No. 1, 5, 6, 8). On information and belief, Nokia had actual knowledge of the application that led to the issuance of the '246 patent since at least as early as June 19, 2009, and at the latest by July 24, 2009. On information and belief, Nokia has had actual knowledge of the '246 patent since at least as early as family members of the '246 patent were cited during the prosecution of Nokia's patent applications as discussed above in paragraphs 74-76. On information and belief, Nokia developed, commercialized, demonstrated, and/or tested the Infringing Products despite its evaluation and knowledge of the Nortel patent portfolio, including the application that led to the issuance of the '246 patent, and its knowledge of family members of the '246 patent from prosecution of Nokia's own patent applications. Nokia has taken action intending to cause others to directly infringe the '246 patent, including by selling or offering for sale the Infringing Products to third parties in the United States while expressly promoting these products' capability to practice the LTE Standards (including the cell-specific reference signals in the manner described above), knowing that using these products to practice the LTE Standards would constitute direct infringement of the '246 patent. Therefore, on information and belief, Nokia knew or should have known of the '246 patent and of its own infringing acts, or deliberately took steps to avoid learning of those facts.

142. Nokia knowingly and intentionally encourages and aids at least its end-user customers to directly infringe the '246 patent. Nokia's end-user customers directly infringe at least Claims 1, 3, 8-10, 15, 17, 22, and 23 of the '246 patent by using the Infringing Products in their intended manner (including the use of cell-specific reference signals in the manner described above) to infringe. Nokia induces such infringement by providing the Infringing Products, together with services, instructions, and technical support to enable and facilitate infringement (including by use of cell-specific reference signals in the manner described above), knowing of, or being willfully blind to the existence of, the '246 patent. On information and belief, Nokia specifically intends that its actions will result in infringement of at least Claims 1, 3, 8-10, 15, 17, 22, and 23 of the '246 patent, or subjectively believes that its actions will result in infringement of the '246 patent but took deliberate actions to avoid learning of those facts, as set forth above. Nokia has persisted in encouraging the use of the LTE-compliant Infringing Products by its customers in a manner that infringes at least Claims 1, 3, 8-10, 15, 17, 22, and 23 of the '246 patent (including by use of cell-specific reference signals in the manner described above), without a license from BlackBerry.

143. Nokia contributorily infringes at least Claims 1, 3, 8-10, 15, 17, 22, and 23 of the '246 patent by providing to its customers the Infringing Products that perform or embody a material part of the claimed inventions of the '246 patent, that are known by Nokia to be specially made or adapted for use in an infringing manner, and are not staple articles with substantial non-infringing uses. The Infringing Products are specially designed to infringe at least Claims 1, 3, 8-10, 15, 17, 22, and 23 of the '246 patent (including by use of cell-specific reference signals in the manner described above), and the Infringing Products have no substantial non-infringing uses. Nokia has known its customers infringe at least Claims 1, 3, 8-10, 15, 17,

22, and 23 of the '246 patent by using the Infringing Products to practice these claims at latest as a result of BlackBerry filing and serving the original complaint in this action (ECF Nos. 1, 5, 6, 8).

144. Nokia Corporation knowingly and intentionally encourages and aids at least subsidiaries Nokia Solutions and Networks Oy and Nokia Solutions and Networks US to directly infringe the '246 patent. Nokia Solutions and Networks Oy knowingly and intentionally encourages and aids at least subsidiaries Nokia Solutions and Networks US to directly infringe the '246 patent. Nokia Solutions and Networks Oy and Nokia Solutions and Networks US directly infringe at least Claims 1, 3, 8-10, 15, 17, 22, and 23 of the '246 patent at least by offering for sale, selling, making, and using the Infringing Products in Claims 1, 3, 8-10, 15, 17, 22, and 23 of the '246 the United States (including those incorporating cell-specific reference signals in the manner described above). Nokia Corporation and Nokia Solutions and Networks Oy induce such direct infringement by encouraging, aiding, technically supporting, and instructing their subsidiaries to sell, offer for sale, make, and use the Infringing Products in the United States (including those incorporating cell-specific reference signals in the manner described above). Nokia Corporation and Nokia Solutions and Networks Oy further induce such direct infringement by encouraging, aiding, technically supporting, and instructing their subsidiaries to design and configure the Infringing Products so that they comply with the LTE standards (including the cell-specific reference signals described above) in a manner that infringes at least Claims 1, 3, 8-10, 15, 17, 22, and 23 of the '246 patent. On information and belief, Nokia Corporation and Nokia Solutions and Networks Oy specifically intend that their actions will result in infringement of at least Claims 1, 3, 8-10, 15, 17, 22, and 23 of the '246 patent, or subjectively believes that their actions will result in infringement of the '246

patent but took deliberate actions to avoid learning of those facts, as set forth above. Nokia Corporation and Nokia Solutions and Networks Oy have persisted in encouraging the use of the LTE-compliant Infringing Products by their subsidiaries in a manner that infringes at least Claims 1, 3, 8-10, 15, 17, 22, and 23 of the '246 patent (including by incorporating cell-specific reference signals in the manner described above), without a license from BlackBerry.

145. Nokia Corporation and Nokia Solutions and Networks Oy contributorily infringe at least Claims 1, 3, 8-10, 15, 17, 22, and 23 of the '246 patent by providing, respectively, to Nokia Solutions and Networks Oy and Nokia Solutions and Networks US and to Nokia Solutions and Networks US the Infringing Products, and/or software or hardware components thereof, that perform or embody a material part of the claimed inventions of the '246 patent, that are known by Nokia Corporation and Nokia Solutions and Networks Oy to be specially made or adapted for use in an infringing manner (including by use of cell-specific reference signals in the manner described above), and are not staple articles, nor have substantial non-infringing uses. Nokia Corporation and Nokia Solutions and Networks Oy have known their subsidiaries infringe at least Claims 1, 3, 8-10, 15, 17, 22, and 23 of the '246 patent by offering for sale, selling, making, and using the Infringing Products and/or software or hardware components thereof to practice these claims at latest as a result of BlackBerry filing and serving the original complaint in this action (ECF Nos. 1, 5, 6, 8).

146. Nokia's infringement has been, and continues to be, willful and deliberate, and has caused substantial damage to BlackBerry. In spite of Nokia's knowledge of the '246 patent, Nokia has continued making, using, offering for sale/lease, and/or selling or leasing in the United States, and/or importing into the United States, the Infringing Products that are compliant with the LTE Standards (including the cell-specific reference signals described above), without a

license from BlackBerry. In spite of Nokia's knowledge of the '246 patent, Nokia has continued its conduct constituting induced infringement and contributory infringement of that patent. In committing acts of direct and indirect infringement, Nokia has committed egregious misconduct including, for example, acting despite knowing that its actions constituted infringement of the valid '246 patent, or recklessly disregarding the fact that its actions constituted an unjustifiably high risk of infringement of the valid and enforceable '246 patent. Nokia's willful and deliberate infringement warrants an award of enhanced damages.

**THIRD CLAIM FOR RELIEF
(INFRINGEMENT OF UNITED STATES PATENT NO. 8,494,090)**

147. BlackBerry realleges and incorporates by reference the allegations of paragraphs 1-146 of this Amended Complaint.

The '090 Patent

148. The '090 patent is directed to, among other things, methods for "transmitting at least the scrambled LTE broadcast channel data using at least one antenna, wherein the scrambling sequence used for scrambling is dependent upon the number of antenna used for said transmitting, the scrambling sequence associated with a particular number of antennas is unique," and "transmitting at least the scrambled LTE broadcast channel data within a primary broadcast channel in accordance with a Long Term Evolution (LTE) standard." (Exhibit C, '090 patent, Claim 11.) The '090 patent is also directed to a "communications device" configured to "transmit at least the scrambled LTE broadcast channel data using at least one antenna, wherein the communications device scrambles the at least a portion of LTE broadcast channel data." (*Id.*, Claim 16.)

149. The '090 patent explains that "LTE employs advanced technologies that are relatively new to wireless cellular networks, including orthogonal frequency division

multiplexing (OFDM) and multiple input multiple output (MIMO) antenna technologies. . . . [T]he downlink employs orthogonal frequency division multiple access (OFDMA).” (*Id.* at 1:45-51.) “Within an LTE communication system, base stations may utilize one of a number of available antenna diversity schemes based on the number of transmit antenna ports for downlink transmission to the user equipment (UE).” (*Id.* at 2:14-17.) “Knowing the number of base station transmit antennas (antenna configuration) is critical information for the UE because it is necessary to decode data transmission correctly after initial access. For example, utilization of two or four base station transmit antenna ports, as compared to one, increases system data rates, reliability and/or quality of service.” (*Id.* at 2:27-33.)

150. The '090 patent explains that a broadcast channel (BCH) typically utilizes a cyclic redundancy check (CRC), such that “data transmitted in the BCH includes two distinct segments: the transport block data and CRC parity bits (computed from the transport block data).” (*Id.* at 3:8-14.)

151. At the time of the invention of the '090 patent, “each transmission scheme ha[d] a large portion of its signal which is identical for all the transmit antenna diversity schemes.” (*Id.* at 3:20-23.) “[I]t is possible that a UE may correctly decode the BCH [broadcast channel] using the incorrect number of transmit antenna ports. Therefore, the UE may determine that the base station is transmitting using one scheme (1, 2, or 4 transmit antenna ports), when in fact, it is transmitting using a different scheme.” (*Id.* at 3:50-55.)

152. The '090 patent discloses methods that involve “scrambling data bits of the generated data according to one of a number of predetermined scrambling sequences.” (*Id.* at 4:3-6.) Each scrambling sequence “corresponds to a defined number of transmit antenna ports operating within the transmitter,” and the method includes “transmitting the scrambled data bits

within a data frame to the remote communication device.” (*Id.* at 4:7-11.) The ’090 patent also discloses a communications device with a transmitter that includes “a scrambler for scrambling data bits to be transmitted in accordance with a one of the stored scrambling sequences, where each of the scrambling sequences is associated with a different one of the sets of transmit antenna ports.”

’090 Patent Allegations

153. Nokia has infringed and is infringing, either literally or under the doctrine of equivalents, all of the claims of the ’090 patent (including claim 1) in violation of 35 U.S.C. § 271 *et seq.*, directly and/or indirectly, by making, using, offering for sale/lease, and/or selling or leasing in the United States, and/or importing into the United States, without authority or license, the Infringing Products.

154. On information and belief, by complying with LTE Standards, including those set forth in the 3GPP TS 36.211 and 3GPP TS 36.212 specification, the Infringing Products including or coupled to at least one transmit antenna for use in an LTE network, and/or their use, are covered by all of the claims of the ’090 patent (including claim 1). For example, Sections 5.3.1 and 5.3.1.1 of the 3GPP TS 36.212 V8.8.0 specification describe scrambling transmitted bits with a predetermined mask as a function of the number of transmit antenna ports at the base station (eNodeB or eNB), organized into BCH transport blocks delivered to layer 1 (i.e., the physical layer described in the 3GPP TS 36.211 V8.9.0 specification).

5.3.1.1 Transport block CRC attachment

Error detection is provided on BCH transport blocks through a Cyclic Redundancy Check (CRC).

The entire transport block is used to calculate the CRC parity bits. Denote the bits in a transport block delivered to layer 1 by $a_0, a_1, a_2, a_3, \dots, a_{A-1}$, and the parity bits by $p_0, p_1, p_2, p_3, \dots, p_{L-1}$. A is the size of the transport block and set to 24 bits and L is the number of parity bits. The lowest order information bit a_0 is mapped to the most significant bit of the transport block as defined in Section 6.1.1 of [5].

The parity bits are computed and attached to the BCH transport block according to subclause 5.1.1 setting L to 16 bits. After the attachment, the CRC bits are scrambled according to the eNodeB transmit antenna configuration with the sequence $x_{ant,0}, x_{ant,1}, \dots, x_{ant,15}$ as indicated in Table 5.3.1.1-1 to form the sequence of bits $c_0, c_1, c_2, c_3, \dots, c_{K-1}$ where

$$c_k = a_k \quad \text{for } k = 0, 1, 2, \dots, A-1$$

$$c_k = (p_{k-A} + x_{ant,k-A}) \bmod 2 \quad \text{for } k = A, A+1, A+2, \dots, A+15.$$

Table 5.3.1.1-1: CRC mask for PBCH

Number of transmit antenna ports at eNodeB	PBCH CRC mask $\langle x_{ant,0}, x_{ant,1}, \dots, x_{ant,15} \rangle$
1	$\langle 0, 0, 0, 0, 0, 0, 0, 0, 0, 0, 0, 0, 0, 0, 0, 0 \rangle$
2	$\langle 1, 1, 1, 1, 1, 1, 1, 1, 1, 1, 1, 1, 1, 1, 1, 1 \rangle$
4	$\langle 0, 1, 0, 1, 0, 1, 0, 1, 0, 1, 0, 1, 0, 1, 0, 1 \rangle$

In Sections 6.6 and 6.6.4 of the 3GPP TS 36.211 V8.9.0 specification, for example, the scrambled LTE Broadcast Channel Data is transmitted within a broadcast channel (i.e., these sections are a portion of the 3GPP technical specification describing transmitting the plurality of scrambled bits within a data frame to a remote communication device).

6.6 Physical broadcast channel

...

6.6.4 Mapping to resource elements

The block of complex-valued symbols $y^{(p)}(0), \dots, y^{(p)}(M_{\text{symb}} - 1)$ for each antenna port is transmitted during 4 consecutive radio frames starting in each radio frame fulfilling $n_f \bmod 4 = 0$ and shall be mapped in sequence starting with $y(0)$ to resource elements (k, l) . The mapping to resource elements (k, l) not reserved for transmission of reference signals shall be in increasing order of first the index k , then the index l in slot 1 in subframe 0 and finally the radio frame number. The resource-element indices are given by

155. Nokia has been, and currently is, an active inducer of infringement of the '090 patent under 35 U.S.C. § 271(b) and a contributory infringer of the '090 patent under 35 U.S.C. § 271(c).

156. On information and belief, the Infringing Products implement hardware and/or software configured to perform or embody the patented limitations of the claims of the '090 patent. For example, the Infringing Products contain hardware and/or software designed to

scramble and transmit a plurality of bits using a first scrambling sequence when one transmit antenna port is used and a second scrambling sequence when two transmit antenna ports are used. On information and belief, the portion of the hardware and/or software that performs or embodies the patented limitations has no substantial non-infringing uses. In particular, because the patented limitations cover mandatory features of the LTE Standards (including features set forth in the 3GPP TS 36.211 and 3GPP TS 36.212 specifications), the portion of the hardware and/or software of the Infringing Products that performs or embodies the patented limitations cannot feasibly be removed or disabled.

157. Nokia knew of the '090 patent, or should have known of the '090 patent but was willfully blind to its existence. Nokia knew of the '090 patent and was put on notice of its infringement through a notice letter sent from BlackBerry prior to the filing of the original complaint in this action on February 14, 2017, and as a result of BlackBerry filing and serving the original complaint in this action (ECF Nos. 1, 5, 6, 8). [REDACTED]

[REDACTED]

[REDACTED]

[REDACTED]

[REDACTED] On information and belief, Nokia had actual knowledge of the '090 patent's parent application, the '867 application, since at least as early as June 19, 2009, and at the latest by July 24, 2009. On information and belief, Nokia has had actual knowledge of the '090 patent since at least as early as citation to the '867 application during the prosecution of Nokia's patent applications as discussed above in paragraphs 77-78. On information and belief, Nokia developed, commercialized, demonstrated, and/or tested the Infringing Products despite its evaluation and knowledge of the Nortel patent portfolio, including the application that led to

the issuance of the '090 patent, and its knowledge of family members of the '090 patent from prosecution of Nokia's own patent applications. Nokia has taken action intending to cause others to directly infringe the '090 patent, including by selling or offering for sale the Infringing Products to third parties in the United States while expressly promoting these products' capability to practice the LTE Standards, knowing that using these products to practice the LTE Standards (including the broadcast channel bit scrambling scheme described above) would constitute direct infringement of the '090 patent. Therefore, on information and belief, Nokia knew or should have known of the '090 patent and of its own infringing acts, or deliberately took steps to avoid learning of those facts.

158. Nokia knowingly and intentionally encourages and aids at least its end-user customers to directly infringe the '090 patent. Nokia's end-user customers directly infringe all of the claims, but at least claim 1, of the '090 patent by using the Infringing Products in their intended manner (including the broadcast channel bit scrambling scheme described above) to infringe. Nokia induces such infringement by providing the Infringing Products and services, instructions, and technical support to enable and facilitate infringement (including the broadcast channel bit scrambling scheme described above), knowing of, or being willfully blind to the existence of, the '090 patent. On information and belief, Nokia specifically intends that its actions will result in infringement of all of the claims, but at least claim 1, of the '090 patent, or subjectively believes that its actions will result in infringement of the '090 patent but took deliberate actions to avoid learning of those facts, as set forth above. Nokia has persisted in encouraging the use of the LTE-compliant Infringing Products by its customers in a manner that infringes all of the claims, but at least claim 1, of the '090 patent (including by using the broadcast channel bit scrambling scheme described above), without a license from BlackBerry.

159. Nokia contributorily infringes all of the claims, but at least claim 1, of the '090 patent by providing to its customers the Infringing Products and/or software or hardware components that perform or embody a material part of the claimed inventions of the '090 patent, that are known by Nokia to be specially made or adapted for use in an infringing manner, and are not staple articles with substantial non-infringing uses. The Infringing Products are specially designed to infringe all of the claims, but at least claim 1, of the '090 patent (including by using the broadcast channel bit scrambling scheme described above), and their Infringing Products have no substantial non-infringing uses. Nokia has known its customers infringe all of the claims, but at least claim 1, of the '090 patent by using the Infringing Products and/or software or hardware components thereof to practice these claims at latest as a result of BlackBerry filing and serving the original complaint in this action (ECF Nos. 1, 5, 6, 8).

160. Nokia Corporation knowingly and intentionally encourages and aids at least subsidiaries Nokia Solutions and Networks Oy and Nokia Solutions and Networks US to directly infringe the '090 patent. Nokia Solutions and Networks Oy knowingly and intentionally encourages and aids at least subsidiaries Nokia Solutions and Networks US to directly infringe the '090 patent. Nokia Solutions and Networks Oy and Nokia Solutions and Networks US directly infringe all of the claims, but at least claim 1, of the '090 patent at least by offering for sale, selling, making, and using the Infringing Products in the United States (including those incorporating the broadcast channel bit scrambling scheme described above). Nokia Corporation and Nokia Solutions and Networks Oy induce such direct infringement by encouraging, aiding, technically supporting, and instructing their subsidiaries to sell, offer for sale, make, and use the Infringing Products in the United States (including those incorporating the broadcast channel bit scrambling scheme described above). Nokia Corporation and Nokia Solutions and Networks Oy

further induce such direct infringement by encouraging, aiding, technically supporting, and instructing their subsidiaries to design and configure the Infringing Products so that they comply with the LTE standards (including the broadcast channel bit scrambling scheme described above) in a manner that infringes all of the claims, but at least claim 1, of the '090 patent. On information and belief, Nokia Corporation and Nokia Solutions and Networks Oy specifically intend that their actions will result in infringement of all of the claims, but at least claim 1, of the '090 patent, or subjectively believes that their actions will result in infringement of the '090 patent but took deliberate actions to avoid learning of those facts, as set forth above. Nokia Corporation and Nokia Solutions and Networks Oy have persisted in encouraging the offer for sale, sale, making, and use of the LTE-compliant Infringing Products by their subsidiaries in a manner that infringes all of the claims, but at least claim 1, of the '090 patent (including by incorporating the broadcast channel bit scrambling scheme described above), without a license from BlackBerry.

161. Nokia Corporation and Nokia Solutions and Networks Oy contributorily infringe all of the claims, but at least claim 1, of the '090 patent by providing, respectively, to subsidiaries Nokia Solutions and Networks Oy and Nokia Solutions and Networks US and to subsidiaries Nokia Solutions and Networks US the Infringing Products, and/or software or hardware components thereof, that perform or embody a material part of the claimed inventions of the '090 patent, that are known by Nokia Corporation and Nokia Solutions and Networks Oy to be specially made or adapted for use in an infringing manner (including by using the broadcast channel bit scrambling scheme described above), and are not staple articles, nor have substantial non-infringing uses. In particular, on information and belief, because the patented limitations cover features of the LTE Standards that have been widely-used in practice (including the

broadcast channel bit scrambling scheme described above), the portion of the hardware and/or software of the Infringing Products that performs or embodies the patented limitations of all of the claims, but at least claim 1, of the '090 patent cannot feasibly be removed or disabled. Nokia Corporation and Nokia Solutions and Networks Oy have known their subsidiaries infringe all of the claims, but at least claim 1, of the '090 patent by offering for sale, selling, making, and using the Infringing Products and/or software or hardware components thereof to practice these claims at latest as a result of BlackBerry filing and serving the original complaint in this action (ECF Nos. 1, 5, 6, 8).

162. Nokia's infringement has been, and continues to be, willful and deliberate, and has caused substantial damage to BlackBerry. In spite of Nokia's knowledge of the '090 patent, Nokia has continued making, using, offering for sale/lease, and/or selling or leasing in the United States, and/or importing into the United States, the Infringing Products that are compliant with the LTE Standards (including the broadcast channel bit scrambling scheme described above), without a license from BlackBerry. In spite of Nokia's knowledge of the '090 patent, Nokia has continued its conduct constituting induced infringement and contributory infringement of that patent. In committing acts of direct and indirect infringement, Nokia has committed egregious misconduct including, for example, acting despite knowing that its actions constituted infringement of the valid '090 patent, or recklessly disregarding the fact that its actions constituted an unjustifiably high risk of infringement of the valid and enforceable '090 patent. Nokia's willful and deliberate infringement warrants an award of enhanced damages.

**FOURTH CLAIM FOR RELIEF
(INFRINGEMENT OF UNITED STATES PATENT NO. 7,529,305)**

163. BlackBerry realleges and incorporates by reference the allegations of paragraphs 1-162 of this Amended Complaint.

The '305 Patent

164. The '305 patent relates to “combined space-time coding and spatial multiplexing [MIMO], and transmitters adapted to include such functionality.” (Exhibit D, '305 patent, 2:52-54.) It is directed to, among other things, transmitters comprising “a space-time coding block adapted to produce M space-time coded symbols per input set of M symbols . . . , wherein the transmitter comprises a delay arrangement, arranged such that, for each symbol of the M symbol substreams, a time of representation of the symbol in the M space-time coded streams is different for each of the M space-time coded streams . . . such that for each symbol of each input set of M symbols, the M space-time coded symbols that contain a representation of the symbol are transmitted at different times.” (*Id.*, Claim 1.) The '305 patent also is directed to a method comprising “demultiplexing an input symbol stream into M symbol substreams” and “implementing a delay function, arranged such that for each symbol of the M symbol substream, a time of representation of the symbol in the M space-time coded streams is different for each of the M space-time coded streams . . . such that for each symbol of each input set of M symbols, the M space-time coded symbols that contain a representation of the symbol are transmitted at different times.” (*Id.*, Claim 8.)

165. At the time of the invention of the '305 patent, several types of layered space-time coding structures had improved spectral efficiency, but had the same signal-to-noise ratio (SNR) “as those with only a single transmit antenna and a single receive antenna.” (*Id.* at 2:3-7.) The '305 patent explained that it “would be advantageous to have a layered space-time coding structure which provides the improved spectral efficiency, but which also provides improved SNR performance.” (*Id.* at 2:45-47.)

166. The '305 patent provides a “space-time coding function” that has “an orthogonal transform adapted to produce M orthogonal outputs each of which is a function of the M substreams” and “delay elements adapted to insert delays in M orthogonal outputs such that each of the M delayed orthogonal outputs is a function of a given element of each of the M substreams at a different time.” (*Id.* at 3:7-13.)

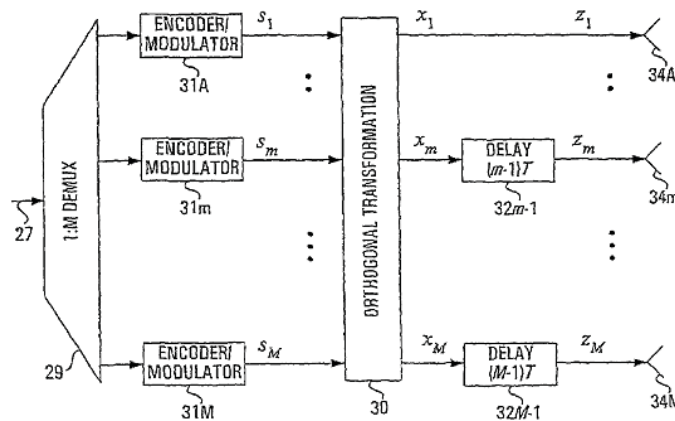

FIG. 4

167. Figure 4 (above) is an example of a transmitter that performs this space-time encoding. The input signal is demultiplexed by “a 1:M demultiplexer 29 having a single primary input 27 and having M outputs which are each coded and modulated . . . to produce encoded substreams s_1, s_2, \dots, s_M .” (*Id.* at 4:4-8.) Further, “[t]here is an orthogonal transformation block 30 and a number of delay blocks 32 . . . the outputs of which are connected to respective antennas 34A.” (*Id.* at 4:8-11.) The '305 patent further states that “[t]he effect of the orthogonal transformation 30 plus the delay blocks 32 is that the m th input symbol s_m is represented in all m output streams, but at different times.” (*Id.* at 4:49-51.)

'305 Patent Allegations

168. Nokia has infringed and is infringing, either literally or under the doctrine of equivalents, at least Claims 1-4 and 8-9 of the '305 patent in violation of 35 U.S.C. § 271 *et seq.*, directly and/or indirectly, by making, using, offering for sale/lease, and/or selling or leasing in the United States, and/or importing into the United States, without authority or license, the Infringing Products.

169. On information and belief, by complying with LTE Standards, including Transmission Mode 3 of the LTE Standards (TM3), the Infringing Products including or coupled to transmit antennas for use in an LTE network, and/or their use, are covered by Claims 1-4 and 8-9 of the '305 patent. For example, Sections 6.3, 6.3.3.2, 6.3.4, 6.3.4.2, 6.3.4.2.2, and 6.3.4.2.3 of the 3GPP TS 36.211 specification describe using “open loop spatial multiplexing” and a “Large Delay Cyclic Delay Diversity (CDD).”

6.3.4.2.2 Precoding for large delay CDD

For large-delay CDD, precoding for spatial multiplexing is defined by

$$\begin{bmatrix} y^{(0)}(i) \\ \vdots \\ y^{(P-1)}(i) \end{bmatrix} = W(i)D(i)U \begin{bmatrix} x^{(0)}(i) \\ \vdots \\ x^{(v-1)}(i) \end{bmatrix}$$

where the precoding matrix $W(i)$ is of size $P \times v$ and $i = 0, 1, \dots, M_{\text{symb}}^{\text{ap}} - 1$, $M_{\text{symb}}^{\text{ap}} = M_{\text{symb}}^{\text{layer}}$. The diagonal size- $v \times v$ matrix $D(i)$ supporting cyclic delay diversity and the size- $v \times v$ matrix U are both given by Table 6.3.4.2.2-1 for different numbers of layers v .

Table 6.3.4.2.2-1: Large-delay cyclic delay diversity

Number of layers ν	U	$D(i)$
2	$\frac{1}{\sqrt{2}} \begin{bmatrix} 1 & 1 \\ 1 & e^{-j2\pi/2} \end{bmatrix}$	$\begin{bmatrix} 1 & 0 \\ 0 & e^{-j2\pi/2} \end{bmatrix}$
3	$\frac{1}{\sqrt{3}} \begin{bmatrix} 1 & 1 & 1 \\ 1 & e^{-j2\pi/3} & e^{-j4\pi/3} \\ 1 & e^{-j4\pi/3} & e^{-j8\pi/3} \end{bmatrix}$	$\begin{bmatrix} 1 & 0 & 0 \\ 0 & e^{-j2\pi/3} & 0 \\ 0 & 0 & e^{-j4\pi/3} \end{bmatrix}$
4	$\frac{1}{2} \begin{bmatrix} 1 & 1 & 1 & 1 \\ 1 & e^{-j2\pi/4} & e^{-j4\pi/4} & e^{-j6\pi/4} \\ 1 & e^{-j4\pi/4} & e^{-j8\pi/4} & e^{-j12\pi/4} \\ 1 & e^{-j6\pi/4} & e^{-j12\pi/4} & e^{-j18\pi/4} \end{bmatrix}$	$\begin{bmatrix} 1 & 0 & 0 & 0 \\ 0 & e^{-j2\pi/4} & 0 & 0 \\ 0 & 0 & e^{-j4\pi/4} & 0 \\ 0 & 0 & 0 & e^{-j6\pi/4} \end{bmatrix}$

Sections 4.2.1.2 and 4.2.1.3 of the 3GPP TS 36.322 V8.8.0 specification describe segmentation of the radio link control service data units, which relates to demultiplexing.

170. On information and belief, Claims 1-4 and 8-9 of the '305 patent are practiced by the MIMO TM3 feature of Nokia's Infringing Products.

171. Nokia has been, and currently is, an active inducer of infringement of the '305 patent under 35 U.S.C. § 271(b), and a contributory infringer of the '305 patent under 35 U.S.C. § 271(c).

172. On information and belief, the Infringing Products implement hardware and/or software configured to perform or embody the patented limitations of at least Claims 1-4 and 8-9 of the '305 patent. For example, the Infringing Products contain hardware and/or software designed to implement "open loop spatial multiplexing" and "Large Delay Cyclic Delay Diversity (CDD)," where the hardware and/or software produces M space-time coded symbols per input set of M symbols arranged such that for each symbol of the M symbol substreams a time of representation of the symbol in the M space-time coded streams is different for each of the M space-time coded streams. On information and belief, the portion of the hardware and/or software that performs or embodies the patented limitations has no substantial non-infringing

uses. In particular, on information and belief, because the patented limitations cover features of the LTE Standards that have been widely-used in practice, viz., TM3, the portion of the hardware and/or software of the Infringing Products that performs or embodies the patented limitations cannot feasibly be removed or disabled.

173. Nokia knew of the '305 patent, or should have known of the '305 patent but was willfully blind to its existence. Nokia knew of the '305 patent and was put on notice of its infringement through a notice letter sent from BlackBerry prior to the filing of the original complaint in this action on February 14, 2017, and as a result of BlackBerry filing and serving the original complaint in this action (ECF Nos. 1, 5, 6, 8). On information and belief, Nokia has had actual knowledge of the '305 patent since at least as early as June 19, 2009, and at the latest by July 24, 2009. On information and belief, Nokia developed, commercialized, demonstrated, and/or tested the Infringing Products despite its evaluation and knowledge of the Nortel patent portfolio, including the '305 patent. Nokia has taken action intending to cause others to directly infringe the '305 patent, including by selling or offering for sale the Infringing Products to third parties in the United States while expressly promoting these products' capability to practice the LTE Standards, including TM3, knowing that using these products to practice the LTE Standards (including the large delay CDD scheme of TM3 described above) would constitute direct infringement of the '305 patent. Therefore, on information and belief, Nokia knew or should have known of the '305 patent and of its own infringing acts, or deliberately took steps to avoid learning of those facts.

174. Nokia knowingly and intentionally encourages and aids at least its end-user customers to directly infringe the '305 patent. Nokia's end-user customers directly infringe at least Claims 1-4 and 8-9 of the '305 patent by using the Infringing Products in their intended

manner (including the use of the large delay CDD scheme of TM3 described above) to infringe. Nokia induces such infringement by providing the Infringing Products and services, instructions, and technical support to enable and facilitate infringement (including the use of the large delay CDD scheme of TM3 described above), knowing of, or being willfully blind to the existence of, the '305 patent. On information and belief, Nokia specifically intends that its actions will result in infringement of at least Claims 1-4 and 8-9 of the '305 patent, or subjectively believes that its actions will result in infringement of the '305 patent but took deliberate actions to avoid learning of those facts, as set forth above. Nokia has persisted in encouraging the use of the LTE-compliant Infringing Products by its customers in a manner that infringes at least Claims 1-4 and 8-9 of the '305 patent (including by use of the large delay CDD scheme of TM3 described above), without a license from BlackBerry.

175. Nokia contributorily infringes at least Claims 1-4 and 8-9 of the '305 patent by providing to its customers the Infringing Products and/or software or hardware components that perform or embody a material part of the claimed inventions of the '305 patent, that are known by Nokia to be specially made or adapted for use in an infringing manner, and are not staple articles with substantial non-infringing uses. The Infringing Products and/or software or hardware components thereof are specially designed to infringe at least Claims 1-4 and 8-9 of the '305 patent (including by use of the large delay CDD scheme of TM3 described above) and have no substantial non-infringing uses. Nokia has known its customers infringe at least Claims 1-4 and 8-9 of the '305 by using the Infringing Products and/or software or hardware components to practice these claims at latest as a result of BlackBerry filing and serving the original complaint in this action (ECF Nos. 1, 5, 6, 8).

176. Nokia Corporation knowingly and intentionally encourages and aids at least subsidiaries Nokia Solutions and Networks Oy and Nokia Solutions and Networks US to directly infringe the '305 patent. Nokia Solutions and Networks Oy knowingly and intentionally encourages and aids at least subsidiaries Nokia Solutions and Networks US to directly infringe the '305 patent. Nokia Solutions and Networks Oy and Nokia Solutions and Networks US directly infringe at least Claims 1-4 and 8-9 of the '305 patent at least by offering for sale, selling, making, and using the Infringing Products in the United States (including those incorporating the large delay CDD scheme of TM3 described above). Nokia Corporation and Nokia Solutions and Networks Oy induce such direct infringement by encouraging, aiding, technically supporting, and instructing their subsidiaries to sell, offer for sale, make, and use the Infringing Products in the United States (including those incorporating the large delay CDD scheme of TM3 described above). Nokia Corporation and Nokia Solutions and Networks Oy further induce such direct infringement by encouraging, aiding, technically supporting, and instructing their subsidiaries to design and configure the Infringing Products so that they comply with the LTE standards (including the large delay CDD scheme of TM3 described above) in a manner that infringes at least Claims 1-4 and 8-9 of the '305 patent. On information and belief, Nokia Corporation and Nokia Solutions and Networks Oy specifically intend that their actions will result in infringement of at least Claims 1-4 and 8-9 of the '305 patent, or subjectively believes that their actions will result in infringement of the '305 patent but took deliberate actions to avoid learning of those facts, as set forth above. Nokia Corporation and Nokia Solutions and Networks Oy have persisted in encouraging the use of the LTE-compliant Infringing Products by their subsidiaries in a manner that infringes at least Claims 1-4 and 8-9 of

the '305 patent (including by incorporating the large delay CDD scheme of TM3 described above), without a license from BlackBerry.

177. Nokia Corporation and Nokia Solutions and Networks Oy contributorily infringe at least Claims 1-4 and 8-9 of the '305 patent by providing, respectively, to Nokia Solutions and Networks Oy and Nokia Solutions and Networks US and to Nokia Solutions and Networks US the Infringing Products, and/or software or hardware components thereof, that perform or embody a material part of the claimed inventions of the '305 patent, that are known by Nokia Corporation and Nokia Solutions and Networks Oy to be specially made or adapted for use in an infringing manner (including by use of the large delay CDD scheme of TM3 described above), and are not staple articles, nor have substantial non-infringing uses. Nokia Corporation and Nokia Solutions and Networks Oy have known their subsidiaries infringe at least Claims 1-4 and 8-9 of the '305 patent by offering for sale, selling, making, and using the Infringing Products and/or software or hardware components thereof to practice these claims at latest as a result of BlackBerry filing and serving the original complaint in this action (ECF Nos. 1, 5, 6, 8).

178. Nokia's infringement has been, and continues to be, willful and deliberate, and has caused substantial damage to BlackBerry. In spite of Nokia's knowledge of the '305 patent, Nokia has continued making, using, offering for sale/lease, and/or selling or leasing in the United States, and/or importing into the United States, the Infringing Products that are compliant with the LTE Standards (including the large delay CDD scheme of TM3 described above), without a license from BlackBerry. In spite of Nokia's knowledge of the '305 patent, Nokia has continued its conduct constituting induced infringement and contributory infringement of that patent. In committing acts of direct and indirect infringement, Nokia has committed egregious misconduct including, for example, acting despite knowing that its actions constituted infringement of the

valid '090 patent, or recklessly disregarding the fact that its actions constituted an unjustifiably high risk of infringement of the valid and enforceable '090 patent. Nokia's willful and deliberate infringement warrants an award of enhanced damages.

**FIFTH CLAIM FOR RELIEF
(INFRINGEMENT OF UNITED STATES PATENT NO. 8,861,433)**

179. BlackBerry realleges and incorporates by reference the allegations of paragraphs 1-178 of this Amended Complaint.

The '433 Patent

180. The '433 patent is directed to, among other things, a method in an "access device associated with a first network cell" for "enabling user equipment (UE) to obtain a service unavailable through a first network cell," by "receiving a request for the UE to access the service" and "identifying, in a message to the UE, a plurality of second network cells providing the service and system information of the plurality of second network cells," wherein "the message identifies location areas of the plurality of second network cells." (Exhibit E, '433 patent, Claim 11 (depending from Claim 1).) The '433 patent is also directed to methods in "an evolved Node B (eNB) associated with a first network cell in an evolved universal terrestrial radio access network (E-UTRAN)" for "enabling user equipment (UE) to obtain a service not available through the first network cell," including a method wherein "the message is a mobility from E-UTRA command ('MobilityFromEUTRACommand')" (*id.*, Claim 21 (depending from Claim 20, which depends from Claim 13)) and a method wherein "the message identifies location areas of the plurality of second network cells" (*id.*, Claim 24 (depending from Claim 13)).

181. The '433 patent explains that "wireless communications networks may implement circuit-switched (CS) and/or packet-switched (PS) communication protocols to provide various

services. For example, the UE may operate in communications networks using different radio access technologies (RAT), such as an Enhanced Universal Terrestrial Radio Access Network (E-UTRAN), Universal Terrestrial Radio Access Network (UTRAN), Global System for Mobile Communications (GSM) network, . . . , Universal Mobile Telecommunications System (UMTS), Enhanced Data rates for GSM Evolution (EDGE), GPRS/EDGE Radio Access Network (GERAN), and/ or General Packet Radio Service (GPRS) technology.” (*Id.* at 1:39-53.) A “CS fallback procedure” could allow a UE connected to a first network using a first RAT to connect to another network using a second RAT. (*Id.* at 2:26-29.) For example, a UE associated with a cell of a network that only provides PS domain services could use CS fallback to initiate voice calls via a cell of a network providing CS domain services. (*Id.* at 2:29-33.)

182. The ’433 patent provides methods that allow identifying to the UE “a plurality of second network cells providing the service and system information of the plurality of second network cells.” (*Id.*, Claim 1.) The UE may be configured “to determine which cell or cells are candidate cells to fallback to.” (*Id.* at 3:26-28.)

’433 Patent Allegations

183. Nokia has infringed and is infringing, either literally or under the doctrine of equivalents, all of the claims of the ’433 patent (including claim 11) in violation of 35 U.S.C. § 271 *et seq.*, directly and/or indirectly, by making, using, offering for sale/lease, and/or selling or leasing in the United States, and/or importing into the United States, without authority or license, the Infringing Products.

184. On information and belief, by complying with LTE Standards for circuit-switched fallback (CSFB) methods that enable 4G operators to provide voice services via 2G and 3G networks, the Infringing Products for use in an LTE network are used to practice the claimed

methods of the '433 patent (including claim 11). The 3GPP TS 23.221 V9.5.0, 3GPP TS 23.272 V9.15.0, 3GPP TS 24.008 V9.12.0, 3GPP TS 24.301 V9.11.0, 3GPP TS 25.331 V9.17.0, 3GPP TS 36.300 V9.10.0, 3GPP TS 36.304 V9.11.0, and 3GPP TS 36.331 V9.17.0 specifications describe "CS fallback" methods that are covered by the claims of the '433 patent.

185. Nokia has a publicly available CS Fallback Brochure that describes how Nokia "has provided CSFB solutions to operators since 2011."

186. An access device associated with a first network cell includes, for example, Infringing Products making up an eNB or MME associated with an E-UTRAN cell as described in Sections 4 and 8 of the 3GPP TS 36.300 V9.10.0 specification, the association established for example by a Cell Identity.

187. The Infringing Products enable a UE to obtain a service unavailable through the E-UTRAN cell, e.g., using a GERAN or UTRAN. For example, Section 4.1 of the 3GPP TS 23.272 V9.15.0 specification provides:

4.1 General Considerations

The CS fallback in EPS enables the provisioning of voice and other CS-domain services (e.g. CS UDI video/ LCS/ USSD) by reuse of CS infrastructure when the UE is served by E-UTRAN. A CS fallback enabled terminal, connected to E-UTRAN may use GERAN or UTRAN to connect to the CS-domain. This function is only available in case E-UTRAN coverage is overlapped by either GERAN coverage or UTRAN coverage.

Moreover, CSFB for the UE is described in Section 3.1 of the 3GPP TS 24.301 V9.11.0 specification, e.g., the UE uses a CS infrastructure for a voice call and other CS services by falling back to a GERAN or UTRAN mode if the UE is served by E-UTRAN when a CS service is requested.

188. The Infringing Products receive a request for the UE to access the service, e.g. a voice call or other CS service. Sections 5.6.1 and 5.6.1.2 of the 3GPP TS 24.301 V9.11.0 specification describe the service request procedure invoked by the UE that is received by the Infringing Products.

189. The Infringing Products identify in a message to the UE, a plurality of second network cells providing the service and system information of the plurality of second network cells. For example, Section 6.2.2 of the 3GPP TS 36.331 V9.17.0 specification describes a RRCConnectionRelease message sent by E-UTRAN to the UE, the fields of the RRCConnectionRelease message identifying the second network cells (e.g., UTRAN cells) and providing the service and system information of the second network cells. The RRCConnectionRelease message, for example, identifies the location areas of the second network cells, for example, in the System Information Container message in the ultra-BCCCH-Container of the RRCConnectionRelease message. The System Information Container is defined in Section 10.2.48 of the 3GPP TS 25.331 V9.17.0 specification, and has an element SysInfoType1 described in Section 10.2.48.8.4 as having “CN common GSM-MAP NAS system information,” which is further shown in Section 10.5.1.12.1 to contain a “Location Area Code.” The Location Area Code is described in Section 10.3.1.7 as “a location area for a GSM-MAP.”

190. Nokia has been, and currently is, an active inducer of infringement of the ’433 patent under 35 U.S.C. § 271(b), and a contributory infringer of the ’433 patent under 35 U.S.C. § 271(c).

191. On information and belief, the Infringing Products implement hardware and/or software configured to perform the patented limitations of the claims of the ’433 patent. For example, the Infringing Products contain hardware and/or software designed to transmit to user equipment (UE) a message containing a plurality of second network cells providing the service and system information of the plurality of second network cells. On information and belief, the portion of the hardware and/or software that performs the patented limitations has no substantial non-infringing uses. In particular, on information and belief, because the patented limitations

cover circuit-switched fallback features of the LTE and UMTS/UTRAN Standards that have been widely-used in practice, the portion of the hardware and/or software of the Infringing Products that performs the patented limitations cannot feasibly be removed or disabled.

192. Nokia knew of the '433 patent, or should have known of the '433 patent but was willfully blind to its existence. Nokia knew of the '433 patent and was put on notice of its infringement through a notice letter sent from BlackBerry prior to the filing of the original complaint in this action on February 14, 2017, and as a result of BlackBerry filing and serving the original complaint in this action (ECF Nos. 1, 5, 6, 8). On information and belief, Nokia has had actual knowledge of the '433 patent since before the filing of the original complaint in this action. Nokia has taken action intending to cause others to directly infringe the '433 patent, including by selling or offering for sale the Infringing Products to third parties in the United States while expressly promoting these products' capability to practice the LTE and UMTS/UTRAN Standards, knowing that using these products to practice the LTE and UMTS/UTRAN Standards (including by implementing CSFB in the manner described above) would constitute direct infringement of the '433 patent. Therefore, on information and belief, Nokia knew or should have known of the '433 patent and of its own infringing acts, or deliberately took steps to avoid learning of those facts.

193. Nokia knowingly and intentionally encourages and aids at least its end-user customers to directly infringe the '433 patent. Nokia's end-user customers directly infringe all of the claims, but at least claim 11, of the '433 patent by using the Infringing Products in their intended manner (including by implementing CSFB in the manner described above) to infringe. Nokia induces such infringement by providing the Infringing Products and services, instructions, and technical support to enable and facilitate infringement (including by implementing CSFB in

the manner described above), knowing of, or being willfully blind to the existence of, the '433 patent. On information and belief, Nokia specifically intends that its actions will result in infringement of all of the claims, but at least claim 11, of the '433 patent, or subjectively believes that its actions will result in infringement of the '433 patent but took deliberate actions to avoid learning of those facts, as set forth above. Nokia has persisted in encouraging the use of the LTE-compliant Infringing Products by its customers in a manner that infringes all of the claims, but at least claim 11, of the '433 patent (including by implementing CSFB in the manner described above), without a license from BlackBerry.

194. Nokia contributorily infringes all of the claims, but at least claim 11, of the '433 patent by providing to its customers the Infringing Products and/or software or hardware components thereof that perform a material part of the claimed inventions of the '433 patent, that are known by Nokia to be specially made or adapted for use in an infringing manner, and are not staple articles with substantial non-infringing uses. The Infringing Products and/or software or hardware components thereof are specially designed to infringe all of the claims, but at least claim 11, of the '433 patent (including by implementing CSFB in the manner described above) and have no substantial non-infringing uses. Nokia has known its customers infringe all of the claims, but at least claim 11, of the '433 patent by using the Infringing Products and/or software or hardware components thereof to practice these claims at latest as a result of BlackBerry filing and serving the original complaint in this action (ECF Nos. 1, 5, 6, 8).

195. Nokia Corporation knowingly and intentionally encourages and aids at least subsidiaries Nokia Solutions and Networks Oy and Nokia Solutions and Networks US to directly infringe the '433 patent. Nokia Solutions and Networks Oy knowingly and intentionally encourages and aids at least subsidiaries Nokia Solutions and Networks US to directly infringe

the '433 patent. Nokia Solutions and Networks Oy and Nokia Solutions and Networks US directly infringe all of the claims, but at least claim 11, of the '433 patent at least by offering for sale, selling, making, and using the Infringing Products in the United States (including those implementing CSFB in the manner described above). Nokia Corporation and Nokia Solutions and Networks Oy induce such direct infringement by encouraging, aiding, technically supporting, and instructing their subsidiaries to sell, offer for sale, make, and use the Infringing Products in the United States (including those implementing CSFB in the manner described above). Nokia Corporation and Nokia Solutions and Networks Oy further induce such direct infringement by encouraging, aiding, technically supporting, and instructing their subsidiaries to design and configure the Infringing Products so that they comply with the LTE standards (including the CSFB scheme described above) in a manner that infringes all of the claims, but at least claim 11, of the '433 patent. On information and belief, Nokia Corporation and Nokia Solutions and Networks Oy specifically intend that their actions will result in infringement of all of the claims, but at least claim 11, of the '433 patent, or subjectively believes that their actions will result in infringement of the '433 patent but took deliberate actions to avoid learning of those facts, as set forth above. Nokia Corporation and Nokia Solutions and Networks Oy have persisted in encouraging the offer for sale, sale, making, and use of the LTE-compliant Infringing Products by their subsidiaries in a manner that infringes all of the claims, but at least claim 11, of the '433 patent (including those implementing CSFB in the manner described above), without a license from BlackBerry.

196. Nokia Corporation and Nokia Solutions and Networks Oy contributorily infringe all of the claims, but at least claim 11, of the '433 patent by providing, respectively, to subsidiaries Nokia Solutions and Networks Oy and Nokia Solutions and Networks US and to

subsidiaries Nokia Solutions and Networks US the Infringing Products, and/or software or hardware components thereof, that perform or embody a material part of the claimed inventions of the '433 patent, that are known by Nokia Corporation and Nokia Solutions and Networks Oy to be specially made or adapted for use in an infringing manner, and are not staple articles, nor have substantial non-infringing uses. The Infringing Products and/or software or hardware components thereof are specially designed to infringe all of the claims, but at least claim 11, of the '433 patent (including by implementing CSFB in the manner described above) and have no substantial non-infringing uses. Nokia Corporation and Nokia Solutions and Networks Oy have known their subsidiaries infringe all of the claims, but at least claim 11, of the '433 patent by offering for sale, selling, making, and using the Infringing Products and/or software or hardware components thereof to practice these claims at latest as a result of BlackBerry filing and serving the original complaint in this action (ECF Nos. 1, 5, 6, 8).

197. Nokia's infringement has been, and continues to be, willful and deliberate, and has caused substantial damage to BlackBerry. In spite of Nokia's knowledge of the '433 patent, Nokia has continued making, using, offering for sale/lease, and/or selling or leasing in the United States, and/or importing into the United States, the Infringing Products that are compliant with the LTE and UMTS/UTRAN Standards (including the CSFB scheme described above), without a license from BlackBerry. In spite of Nokia's knowledge of the '433 patent, Nokia has continued its conduct constituting induced infringement and contributory infringement of that patent. In committing acts of direct and indirect infringement, Nokia has committed egregious misconduct including, for example, acting despite knowing that its actions constituted infringement of the valid '433 patent, or recklessly disregarding the fact that its actions

constituted an unjustifiably high risk of infringement of the valid and enforceable '433 patent. Nokia's willful and deliberate infringement warrants an award of enhanced damages.

**SIXTH CLAIM FOR RELIEF
(INFRINGEMENT OF UNITED STATES PATENT NO. 9,426,697)**

198. BlackBerry realleges and incorporates by reference the allegations of paragraphs 1-197 of this Amended Complaint.

The '697 Patent

199. The '697 patent is directed to, among other things, an "access device associated with a first network cell for enabling user equipment (UE) to obtain a service unavailable through a first network cell," comprising one or more processors configured to "receive a request for the UE to access the service" and "identify, in a message to the UE, a plurality of second network cells providing the service and system information of the plurality of second network cells," wherein "the message identifies location areas of the plurality of second network cells." (Exhibit F, '697 patent, Claim 11 (depending from Claim 1).) The '697 patent is also directed to an "evolved Node B (eNB) associated with a first network cell in an evolved universal terrestrial radio access network (E-UTRAN) for enabling user equipment (UE) to obtain a service not available through the first network cell," including an eNB wherein "the message is a mobility from E-UTRA command ('MobilityFromEUTRACommand')" (*id.*, Claim 21 (depending from Claim 20, which depends from Claim 13)) and an eNB wherein "the message identifies location areas of the plurality of second network cells" (*id.*, Claim 24 (depending from Claim 13)).

200. The '697 patent explains that "wireless communications networks may implement circuit-switched (CS) and/or packet-switched (PS) communication protocols to provide various services. For example, the UE may operate in communications networks using different radio access technologies (RAT), such as an Enhanced Universal Terrestrial Radio Access Network

(E-UTRAN), Universal Terrestrial Radio Access Network (UTRAN), Global System for Mobile Communications (GSM) network, . . . , Universal Mobile Telecommunications System (UMTS), Enhanced Data rates for GSM Evolution (EDGE), GPRS/EDGE Radio Access Network (GERAN), and/ or General Packet Radio Service (GPRS) technology.” (*Id.* at 1:39-53.) A “CS fallback procedure” could allow a UE connected to a first network using a first RAT to connect to another network using a second RAT. (*Id.* at 2:26-29.) For example, a UE associated with a cell of a network that only provides PS domain services could use CS fallback to initiate voice calls via a cell of a network providing CS domain services. (*Id.* at 2:29-33.)

201. The ’697 patent provides an “access device” or “eNB” that allows identifying to the UE “a plurality of second network cells providing the service and system information of the plurality of second network cells.” (*Id.*, Claim 1.) The UE may be configured “to determine which cell or cells are candidate cells to fallback to.” (*Id.* at 3:26-28.)

’697 Patent Allegations

202. Nokia has infringed and is infringing, either literally or under the doctrine of equivalents, all of the claims of the ’697 patent (including claim 11) in violation of 35 U.S.C. § 271 *et seq.*, directly and/or indirectly, by making, using, offering for sale/lease, and/or selling or leasing in the United States, and/or importing into the United States, without authority or license, the Infringing Products.

203. On information and belief, by complying with LTE Standards for circuit-switched fallback (CSFB) methods that enable 4G operators to provide voice services via 2G and 3G networks, the Infringing Products for use in an LTE network are covered by all of the claims of the ’697 patent (including claim 11). The 3GPP TS 23.221 V9.5.0, 3GPP TS 23.272 V9.15.0, 3GPP TS 24.008 V9.12.0, 3GPP TS 24.301 V9.11.0, 3GPP TS 25.331 V9.17.0, 3GPP TS 36.300

V9.10.0, 3GPP TS 36.304 V9.11.0, and 3GPP TS 36.331 V9.17.0 specifications describe “CS fallback” features that are covered by the claims of the ’697 patent.

204. Nokia has a publicly available CS Fallback Brochure that describes how Nokia “has provided CSFB solutions to operators since 2011.”

205. An access device associated with a first network cell includes, for example, Infringing Products making up an eNB or MME associated with an E-UTRAN cell as described in Sections 4 and 8 of the 3GPP TS 36.300 V9.10.0 specification, the association established for example by a Cell Identity.

206. The Infringing Products enable a UE to obtain a service unavailable through the E-UTRAN cell, e.g., using a GERAN or UTRAN. For example, Section 4.1 of the 3GPP TS 23.272 V9.15.0 specification provides:

4.1 General Considerations

The CS fallback in EPS enables the provisioning of voice and other CS-domain services (e.g. CS UDI video/ LCS/ USSD) by reuse of CS infrastructure when the UE is served by E-UTRAN. A CS fallback enabled terminal, connected to E-UTRAN may use GERAN or UTRAN to connect to the CS-domain. This function is only available in case E-UTRAN coverage is overlapped by either GERAN coverage or UTRAN coverage.

Moreover, CSFB for the UE is described in Section 3.1 of the 3GPP TS 24.301 V9.11.0 specification, e.g., the UE uses a CS infrastructure for a voice call and other CS services by falling back to a GERAN or UTRAN mode if the UE is served by E-UTRAN when a CS service is requested.

207. The Infringing Products have processors configured to receive a request for the UE to access the service, e.g. a voice call or other CS service. Sections 5.6.1 and 5.6.1.2 of the 3GPP TS 24.301 V9.11.0 specification describe the service request procedure invoked by the UE that is received by the processors of the Infringing Products.

208. The Infringing Products have processors configured to identify in a message to the UE, a plurality of second network cells providing the service and system information of the

plurality of second network cells. For example, Section 6.2.2 of the 3GPP TS 36.331 V9.17.0 specification describes a RRCConnectionRelease message sent by E-UTRAN to the UE, the fields of the RRCConnectionRelease message identifying the second network cells (e.g., UTRAN cells) and providing the service and system information of the second network cells. The RRCConnectionRelease message, for example, identifies the location areas of the second network cells, for example, in the System Information Container message in the ultra-BCCH-Container of the RRCConnectionRelease message. The System Information Container is defined in Section 10.2.48 of the 3GPP TS 25.331 V9.17.0 specification, and has an element SysInfoType1 described in Section 10.2.48.8.4 as having “CN common GSM-MAP NAS system information,” which is further shown in Section 10.5.1.12.1 to contain a “Location Area Code.” The Location Area Code is described in Section 10.3.1.7 as “a location area for a GSM-MAP.”

209. Nokia has been, and currently is, an active inducer of infringement of the '697 patent under 35 U.S.C. § 271(b), and a contributory infringer of the '697 patent under 35 U.S.C. § 271(c).

210. On information and belief, the Infringing Products implement hardware and/or software configured to perform or embody the patented limitations of the claims of the '697 patent. For example, the Infringing Products contain hardware and/or software designed to transmit to user equipment (UE) a message containing a plurality of second network cells providing the service and system information of the plurality of second network cells. On information and belief, the portion of the hardware and/or software that performs or embodies the patented limitations has no substantial non-infringing uses. In particular, on information and belief, because the patented limitations cover circuit-switched fallback features of the LTE and UMTS/UTRAN Standards that have been widely-used in practice, the portion of the hardware

and/or software of the Infringing Products that performs or embodies the patented limitations cannot feasibly be removed or disabled.

211. Nokia knew of the '697 patent, or should have known of the '697 patent but was willfully blind to its existence. Nokia knew of the '697 patent and was put on notice of its infringement through a notice letter sent from BlackBerry prior to the filing of the original complaint in this action on February 14, 2017, and as a result of BlackBerry filing and serving the original complaint in this action (ECF Nos. 1, 5, 6, 8). On information and belief, Nokia has had actual knowledge of the '697 patent since before the filing of the original complaint in this action. Nokia has taken action intending to cause others to directly infringe the '697 patent, including by selling or offering for sale the Infringing Products to third parties in the United States while expressly promoting these products' capability to practice the LTE and UMTS/UTRAN Standards, knowing that using these products to practice the LTE and UMTS/UTRAN Standards would constitute direct infringement of the '697 patent. Therefore, on information and belief, Nokia knew or should have known of the '697 patent and of its own infringing acts, or deliberately took steps to avoid learning of those facts.

212. Nokia knowingly and intentionally encourages and aids at least its end-user customers to directly infringe the '697 patent. Nokia's end-user customers directly infringe all of the claims, but at least claim 11, of the '697 patent by using the Infringing Products in their intended manner (including by implementing CSFB in the manner described above) to infringe. Nokia induces such infringement by providing the Infringing Products and services, instructions, and technical support to enable and facilitate infringement (including by implementing CSFB in the manner described above), knowing of, or being willfully blind to the existence of, the '697 patent. On information and belief, Nokia specifically intends that its actions will result in

infringement of all of the claims, but at least claim 11, of the '697 patent, or subjectively believes that its actions will result in infringement of the '697 patent but took deliberate actions to avoid learning of those facts, as set forth above. Nokia has persisted in encouraging the use of the LTE-compliant Infringing Products by its customers in a manner that infringes all of the claims, but at least claim 11, of the '697 patent (including by implementing CSFB in the manner described above), without a license from BlackBerry.

213. Nokia contributorily infringes all of the claims, but at least claim 11, of the '697 patent by providing to its customers the Infringing Products and/or software or hardware components thereof that perform or embody a material part of the claimed inventions of the '697 patent, that are known by Nokia to be specially made or adapted for use in an infringing manner, and are not staple articles with substantial non-infringing uses. The Infringing Products and/or software or hardware components thereof are specially designed to infringe all of the claims, but at least claim 11, of the '697 patent (including by implementing CSFB in the manner described above) and have no substantial non-infringing uses. Nokia has known its customers infringe all of the claims, but at least claim 11, of the '697 patent by using the Infringing Products and/or software or hardware components thereof to practice these claims at latest as a result of BlackBerry filing and serving the original complaint in this action (ECF Nos. 1, 5, 6, 8).

214. Nokia Corporation knowingly and intentionally encourages and aids at least subsidiaries Nokia Solutions and Networks Oy and Nokia Solutions and Networks US to directly infringe the '697 patent. Nokia Solutions and Networks Oy knowingly and intentionally encourages and aids at least subsidiaries Nokia Solutions and Networks US to directly infringe the '697 patent. Nokia Solutions and Networks Oy and Nokia Solutions and Networks US directly infringe all of the claims, but at least claim 11, of the '697 patent at least by offering for

sale, selling, making, and using the Infringing Products in the United States (including those implementing CSFB in the manner described above). Nokia Corporation and Nokia Solutions and Networks Oy induce such direct infringement by encouraging, aiding, technically supporting, and instructing their subsidiaries to sell, offer for sale, make, and use the Infringing Products in the United States (including those implementing CSFB in the manner described above). Nokia Corporation and Nokia Solutions and Networks Oy further induce such direct infringement by encouraging, aiding, technically supporting, and instructing their subsidiaries to design and configure the Infringing Products so that they comply with the LTE standards (including the CSFB scheme described above) in a manner that infringes all of the claims, but at least claim 11, of the '697 patent. On information and belief, Nokia Corporation and Nokia Solutions and Networks Oy specifically intend that their actions will result in infringement of all of the claims, but at least claim 11, of the '697 patent, or subjectively believes that their actions will result in infringement of the '697 patent but took deliberate actions to avoid learning of those facts, as set forth above. Nokia Corporation and Nokia Solutions and Networks Oy have persisted in encouraging the offer for sale, sale, making, and use of the LTE-compliant Infringing Products by their subsidiaries in a manner that infringes all of the claims, but at least claim 11, of the '697 patent (including those implementing CSFB in the manner described above), without a license from BlackBerry.

215. Nokia Corporation and Nokia Solutions and Networks Oy contributorily infringe all of the claims, but at least claim 11, of the '697 patent by providing, respectively, to subsidiaries Nokia Solutions and Networks Oy and Nokia Solutions and Networks US and to subsidiaries Nokia Solutions and Networks US the Infringing Products, and/or software or hardware components thereof, that perform or embody a material part of the claimed inventions

of the '697 patent, that are known by Nokia Corporation and Nokia Solutions and Networks Oy to be specially made or adapted for use in an infringing manner, and are not staple articles, nor have substantial non-infringing uses. The Infringing Products and/or software or hardware components thereof are specially designed to infringe all of the claims, but at least claim 11, of the '697 patent (including by implementing CSFB in the manner described above) and have no substantial non-infringing uses. Nokia Corporation and Nokia Solutions and Networks Oy have known their subsidiaries infringe all of the claims, but at least claim 11, of the '697 patent by offering for sale, selling, making, and using the Infringing Products and/or software or hardware components thereof to practice these claims at latest as a result of BlackBerry filing and serving the original complaint in this action (ECF Nos. 1, 5, 6, 8).

216. Nokia's infringement has been, and continues to be, willful and deliberate, and has caused substantial damage to BlackBerry. In spite of Nokia's knowledge of the '697 patent, Nokia has continued making, using, offering for sale/lease, and/or selling or leasing in the United States, and/or importing into the United States, the Infringing Products that are compliant with the LTE and UMTS/UTRAN Standards (including the CSFB scheme described above), without a license from BlackBerry. In spite of Nokia's knowledge of the '697 patent, Nokia has continued its conduct constituting induced infringement and contributory infringement of that patent. In committing acts of direct and indirect infringement, Nokia has committed egregious misconduct including, for example, acting despite knowing that its actions constituted infringement of the valid '697 patent, or recklessly disregarding the fact that its actions constituted an unjustifiably high risk of infringement of the valid and enforceable '697 patent. Nokia's willful and deliberate infringement warrants an award of enhanced damages.

**SEVENTH CLAIM FOR RELIEF
(INFRINGEMENT OF UNITED STATES PATENT NO. 9,253,772)**

217. BlackBerry realleges and incorporates by reference the allegations of paragraphs 1-216 of this Amended Complaint.

The '772 Patent

218. The '772 patent is directed to, among other things, a base station comprising “one or more hardware processors configured to: transmit . . . a component carrier assignment message via a first component carrier,” where the “component carrier assignment message” identifies a “second component carrier,” indicates that the second component carrier “is not a control channel monitoring component carrier,” indicates that the first component carrier’s control channel signals “channel assignment information for the second component carrier,” and includes a physical cell identity (PCI) and an antenna configuration for the second component carrier. (Exhibit G, '772 patent, Claim 9; *see also id.*, Claim 5.) The '772 patent is further directed to a base station comprising “one or more hardware processors configured to: transmit a component carrier message via a first component carrier,” where the “component carrier assignment message” includes a PCI and antenna configuration for each of a second and third component carrier, and an indication that the second component carrier is a “control channel monitoring component carrier,” whereas the first component carrier signals “data channel assignment information for the third component carrier,” which is not a “control monitoring component carrier”; the base station causes a user equipment (UE) “to use the component carrier assignment message to configure the second component carrier and the third component carrier on the UE.” (*Id.*, Claim 14.)

219. The '772 patent explains that, in mobile communications systems such as E-UTRAN, a base station has a scheduler “for dynamically scheduling downlink traffic data

packet transmissions and allocating uplink traffic data transmission resources,” which “sends scheduling information to [user agents] through a control channel.” (*Id.* at 1:60-65.) A plurality of different communication channels are established between a base station and user equipment (UE), including a Physical Downlink Control Channel (PDCCH) that “transmits scheduling assignment and control data packets,” a “Physical Downlink Shared Channel (PDSCH),” and a “Physical Uplink Shared Channel (PUSCH).” (*Id.* at 2:6-20.)

220. The ’772 patent also explains that, under carrier aggregation, multiple “component carriers are aggregated and may be allocated in a sub-frame to a UE,” and the UE “may receive or transmit on multiple component carriers.” (*Id.* at 2:27-35.) Carrier aggregation “can be used to support wider transmission bandwidths and increase the potential peak data rate for communications between a UE, base station, and/or other network components.” (*Id.* at 2:25-27.)

221. At the time of the invention of the ’772 patent, in existing multi-carrier communications network implementations, “existing standards fail to describe how the assignment and activation of a [component carrier] CC to a UE is performed, how a UE switches from one CC to another, [and] how to define the CCs assigned to a particular UE.” (*Id.* at 4:18-23.)

222. The ’772 patent explains that “[f]or the CCs within the Active CC set of the UE, the UE needs to know the up-to-date system information (e.g., MIB, SIB1, SIB2) associated with each CC.” (*Id.* at 19:3-5.) It discusses that “when a CC is assigned to the UE by the base station, the necessary SI of the CC is provided to the UE via RRC signaling, if such information is not already broadcast by the base station,” (*id.* at 19:10-13), and teaches that “when a CC is first assigned to the UE, detailed information of the CC is also signaled to the UE via dedicated

signaling carried on one or multiple CCs in the Active CC set of the UE,” (*id.* at 19:15-18). Such information may include “SIB1 related information such as PCI” and “antenna configuration on the carrier.” (*Id.* at 19:18-19, 19:32-37.)

'772 Patent Allegations

223. Nokia has infringed and is infringing, either literally or under the doctrine of equivalents, at least Claims 5-17 of the '772 patent in violation of 35 U.S.C. § 271 *et seq.*, directly and/or indirectly, by making, using, offering for sale/lease, and/or selling or leasing in the United States, and/or importing into the United States, without authority or license, the Infringing Products.

224. By complying with LTE Standards, including those set forth in the 3GPP TS 36.213 and 3GPP TS 36.331 specifications, the Infringing Products for use in an LTE network, and/or their use, are covered by at least Claims 5-17 of the '772 patent.

225. Section 9.1 of the 3GTPP TS 36.213 V10.13.0 specification provides the following UE procedure for determining physical downlink control channel assignment.

9 Physical downlink control channel procedures

9.1 UE procedure for determining physical downlink control channel assignment

9.1.1 PDCCH Assignment Procedure

...

The UE shall monitor one common search space at each of the aggregation levels 4 and 8 on the primary cell.

226. The Infringing Products transmit to a UE a component carrier assignment message, for example the *RRCCONNECTIONRECONFIGURATION* message described below, using the physical downlink control channel via a first component carrier different from a second component carrier identifying information about the second component carrier that satisfies all of

the claim elements, for example, of Claim 5. Section 6.2.2 of the 3GPP TS 36.331 V10.19.0 specification specifies a *RRCConnectionReconfiguration* message that includes information such as a physical cell identity, as shown in the portion of the message reproduced below (*see* “physCellID-r10” and “PhysCellId”).

– ***RRCConnectionReconfiguration***

The *RRCConnectionReconfiguration* message is the command to modify an RRC connection. It may convey information for measurement configuration, mobility control, radio resource configuration (including RBs, MAC main configuration and physical channel configuration) including any associated dedicated NAS information and security configuration.

Signalling radio bearer: SRB1

RLC-SAP: AM

Logical channel: DCCH

Direction: E-UTRAN to UE

RRCConnectionReconfiguration message

```
-- ASN1START
RRCConnectionReconfiguration ::= SEQUENCE {
  rrc-TransactionIdentifier      RRC-TransactionIdentifier,
  criticalExtensions             CHOICE {
    c1                           CHOICE {
      rrcConnectionReconfiguration-r8      RRCConnectionReconfiguration-r8-IEs,
      spare7 NULL,
      spare6 NULL, spare5 NULL, spare4 NULL,
      spare3 NULL, spare2 NULL, spare1 NULL
    },
    criticalExtensionsFuture           SEQUENCE {}
  }
}

RRCConnectionReconfiguration-r8-IEs ::= SEQUENCE {
  measConfig                      MeasConfig                      OPTIONAL, -- Need ON
  mobilityControlInfo             MobilityControlInfo          OPTIONAL, -- Cond HO
  dedicatedInfoNASList            SEQUENCE (SIZE (1..maxDRB)) OF
    DedicatedInfoNAS              OPTIONAL, -- Cond nonHO
  radioResourceConfigDedicated    RadioResourceConfigDedicated OPTIONAL, -- Cond HO-toEUTRA
  securityConfigHO                SecurityConfigHO            OPTIONAL, -- Cond HO
  nonCriticalExtension            RRCConnectionReconfiguration-v890-IEs OPTIONAL
}

RRCConnectionReconfiguration-v890-IEs ::= SEQUENCE {
  lateNonCriticalExtension         OCTET STRING                OPTIONAL, -- Need OP
  nonCriticalExtension             RRCConnectionReconfiguration-v920-IEs OPTIONAL
}

RRCConnectionReconfiguration-v920-IEs ::= SEQUENCE {
  otherConfig-r9                  OtherConfig-r9              OPTIONAL, -- Need ON
  fullConfig-r9                   ENUMERATED {true}           OPTIONAL, -- Cond HO-
Reestab
  nonCriticalExtension            RRCConnectionReconfiguration-v1020-IEs OPTIONAL
}
-- ASN1END
```

```

RRCConnectionReconfiguration-v1020-IEs ::= SEQUENCE {
  sCellToReleaseList-r10          SCellToReleaseList-r10          OPTIONAL, -- Need ON
  sCellToAddModList-r10          SCellToAddModList-r10          OPTIONAL, -- Need ON
  nonCriticalExtension            SEQUENCE {}                       OPTIONAL  -- Need OP
}

SCellToAddModList-r10 ::= SEQUENCE (SIZE (1..maxSCell-r10)) OF SCellToAddMod-r10

SCellToAddMod-r10 ::= SEQUENCE {
  sCellIndex-r10                SCellIndex-r10,
  cellIdentification-r10        SEQUENCE {
    physCellId-r10              PhysCellId,

```

227. Section 6.3.2 of the 3GPP TS 36.331 V10.19.0 specification describes radio resource control information elements such as the *RadioResourceConfigDedicated* information element, *PhysicalConfigDedicated* information element, and *CrossCarrierSchedulingConfig* information element (reproduced below).

– ***RadioResourceConfigDedicated***

The IE *RadioResourceConfigDedicated* is used to setup/modify/release RBs, to modify the MAC main configuration, to modify the SPS configuration and to modify dedicated physical configuration.

...

– ***PhysicalConfigDedicated***

The IE *PhysicalConfigDedicated* is used to specify the UE specific physical channel configuration.

...

– ***CrossCarrierSchedulingConfig***

The IE *CrossCarrierSchedulingConfig* is used to specify the configuration when the cross carrier scheduling is used in a cell.

***CrossCarrierSchedulingConfig* information elements**

```

-- ASN1START
CrossCarrierSchedulingConfig-r10 ::= SEQUENCE {
  schedulingCellInfo-r10 CHOICE {
    own-r10 SEQUENCE { -- No cross carrier
      scheduling
        cif-Presence-r10 BOOLEAN
      },
    other-r10 SEQUENCE { -- Cross carrier
      scheduling
        schedulingCellId-r10 ServCellIndex-r10,
        pdsch-Start-r10 INTEGER (1..4)
      }
    }
  }
-- ASN1STOP

```

The *CrossCarrierSchedulingConfig* information elements include an indication that the second component carrier is not a control channel monitoring component carrier (see “other-r10”) and an indication that a control channel of the first component carrier is configured to signal channel assignment information for the second component carrier (see “schedulingCellID-r10”/”ServCellIndex-r0”).

228. Section 6.3.2 of the 3GPP TS 36.331 V10.19.0 specification also describes radio resource control elements such as the *AntennaInfo* and *AntennaInfoDedicated* information elements (reproduced below).

– *AntennaInfo*

The IE *AntennaInfoCommon* and the *AntennaInfoDedicated* are used to specify the common and the UE specific antenna configuration respectively.

AntennaInfo information elements

```
-- ASN1START
AntennaInfoCommon ::=
    antennaPortsCount
}
SEQUENCE {
    ENUMERATED {an1, an2, an4, spare1}
}

AntennaInfoDedicated ::=
    transmissionMode
    codebookSubsetRestriction
    n2TxAntenna-tm3
    n4TxAntenna-tm3
    n2TxAntenna-tm4
    n4TxAntenna-tm4
    n2TxAntenna-tm5
    n4TxAntenna-tm5
    n2TxAntenna-tm6
    n4TxAntenna-tm6
}
OPTIONAL,
-- Cond TM
SEQUENCE {
    ENUMERATED {
        tm1, tm2, tm3, tm4, tm5, tm6,
        tm7, tm8-v920},
    CHOICE {
        BIT STRING (SIZE (2)),
        BIT STRING (SIZE (4)),
        BIT STRING (SIZE (6)),
        BIT STRING (SIZE (64)),
        BIT STRING (SIZE (4)),
        BIT STRING (SIZE (16)),
        BIT STRING (SIZE (4)),
        BIT STRING (SIZE (16))
    }
}

ue-TransmitAntennaSelection
    release
    setup
}
CHOICE{
    NULL,
    ENUMERATED {closedLoop, openLoop}
}
}
```

```

AntennaInfoDedicated-v920 ::= SEQUENCE {
  codebookSubsetRestriction-v920 CHOICE {
    n2TxAntenna-tm8-r9 BIT STRING (SIZE (6)),
    n4TxAntenna-tm8-r9 BIT STRING (SIZE (32))
  } OPTIONAL -- Cond TM8
}

AntennaInfoDedicated-r10 ::= SEQUENCE {
  transmissionMode-r10 ENUMERATED {
    tm1, tm2, tm3, tm4, tm5, tm6, tm7, tm8-v920,
    tm9-v1020, spare7, spare6, spare5, spare4,
    spare3, spare2, spare1},
  codebookSubsetRestriction-r10 BIT STRING OPTIONAL, -- Cond TMX
  ue-TransmitAntennaSelection CHOICE{
    release NULL,
    setup ENUMERATED {closedLoop, openLoop}
  }
}

-- ASN1STOP

```

229. Moreover, on information and belief, the Infringing Products support cross-carrier scheduling, wherein the control channel at one carrier can be used to allocate resources at another carrier for user data transmission in accordance with the LTE standards as described above.

230. Nokia has been, and currently is, an active inducer of infringement of the '772 patent under 35 U.S.C. § 271(b) and a contributory infringer of the '772 patent under 35 U.S.C. § 271(c).

231. On information and belief, the Infringing Products implement hardware and/or software configured to perform or embody the patented limitations of at least Claims 5-17 of the '772 patent. On information and belief, the Infringing Products contain hardware and/or software designed to implement carrier aggregation with cross-carrier scheduling, wherein the control channel at one carrier can be used to allocate resources at another carrier for user data transmission. On information and belief, the portion of the hardware and/or software that performs or embodies the patented limitations has no substantial non-infringing uses. In particular, on information and belief, because the patented limitations cover features of the LTE Standards that have been widely-used in practice, viz., cross-carrier scheduling as described

above, the portion of the hardware and/or software of the Infringing Products that performs or embodies the patented limitations cannot feasibly be removed or disabled.

232. Nokia knew of the '772 patent, or should have known of the '772 patent but was willfully blind to its existence. Nokia knew of the '772 patent and was put on notice of its infringement through a notice letter sent from BlackBerry prior to the filing of the original complaint in this action on February 14, 2017, and as a result of BlackBerry filing and serving the original complaint in this action (ECF Nos. 1, 5, 6, 8). On information and belief, Nokia has had actual knowledge of the '772 patent since at least as early as its parent application, the '964 publication, was cited by the examiners during the prosecution of Nokia's patent applications as discussed above in paragraphs 79-80. On information and belief, Nokia developed, commercialized, demonstrated, and/or tested the Infringing Products despite its knowledge of family members of the '772 patent based on prosecution of Nokia's own patent applications. Nokia has taken action intending to cause others to directly infringe the '772 patent, including by selling or offering for sale the Infringing Products to third parties in the United States while expressly promoting these products' capability to practice the LTE Standards (including the carrier scheduling/assignment scheme described above), knowing that using these products to practice the LTE Standards would constitute direct infringement of the '772 patent. Therefore, on information and belief, Nokia knew or should have known of the '772 patent and of its own infringing acts, or deliberately took steps to avoid learning of those facts.

233. Nokia knowingly and intentionally encourages and aids at least its end-user customers to directly infringe the '772 patent. Nokia's end-user customers directly infringe at least Claims 5-17 of the '772 patent by using the Infringing Products in their intended manner (including use of the carrier scheduling/assignment scheme described above) to infringe. Nokia

induces such infringement by providing the Infringing Products, together with services, instructions, and technical support to enable and facilitate infringement (including by use of the carrier scheduling/assignment scheme described above), knowing of, or being willfully blind to the existence of, the '772 patent. On information and belief, Nokia specifically intends that its actions will result in infringement of at least Claims 5-17 of the '772 patent, or subjectively believes that its actions will result in infringement of the '772 patent but took deliberate actions to avoid learning of those facts, as set forth above. Nokia has persisted in encouraging the use of the LTE-compliant Infringing Products by its customers in a manner that infringes at least Claims 5-17 of the '772 patent (including by use of the carrier scheduling/assignment scheme described above), without a license from BlackBerry.

234. Nokia contributorily infringes at least Claims 5-17 of the '772 patent by providing to its customers the Infringing Products that perform or embody a material part of the claimed inventions of the '772 patent, that are known by Nokia to be specially made or adapted for use in an infringing manner, and are not staple articles with substantial non-infringing uses. The Infringing Products are specially designed to infringe at least Claims 5-17 of the '772 patent (including by use of the carrier scheduling/assignment scheme described above), and the Infringing Products have no substantial non-infringing uses. Nokia has known its customers infringe at least Claims 5-17 of the '772 patent by using the Infringing Products to practice these claims at latest as a result of BlackBerry filing and serving the original complaint in this action (ECF Nos. 1, 5, 6, 8).

235. Nokia Corporation knowingly and intentionally encourages and aids at least subsidiaries Nokia Solutions and Networks Oy and Nokia Solutions and Networks US to directly infringe the '772 patent. Nokia Solutions and Networks Oy knowingly and intentionally

encourages and aids at least subsidiaries Nokia Solutions and Networks US to directly infringe the '772 patent. Nokia Solutions and Networks Oy and Nokia Solutions and Networks US directly infringe at least Claims 5-17 of the '772 patent at least by offering for sale, selling, making, and using the Infringing Products in the United States (including those incorporating the carrier scheduling/assignment scheme described above). Nokia Corporation and Nokia Solutions and Networks Oy induce such direct infringement by encouraging, aiding, technically supporting, and instructing their subsidiaries to sell, offer for sale, make, and use the Infringing Products in the United States (including those incorporating the carrier scheduling/assignment scheme described above). Nokia Corporation and Nokia Solutions and Networks Oy further induce such direct infringement by encouraging, aiding, technically supporting, and instructing their subsidiaries to design and configure the Infringing Products so that they comply with the LTE standards (including the carrier scheduling/assignment scheme described above) in a manner that infringes at least Claims 5-17 of the '772 patent. On information and belief, Nokia Corporation and Nokia Solutions and Networks Oy specifically intend that their actions will result in infringement of at least Claims 5-17 of the '772 patent, or subjectively believes that their actions will result in infringement of the '772 patent but took deliberate actions to avoid learning of those facts, as set forth above. Nokia Corporation and Nokia Solutions and Networks Oy have persisted in encouraging the use of the LTE-compliant Infringing Products by their subsidiaries in a manner that infringes at least Claims 5-17 of the '772 patent (including by incorporating the carrier scheduling/assignment scheme described above), without a license from BlackBerry.

236. Nokia Corporation and Nokia Solutions and Networks Oy contributorily infringe at least Claims 5-17 of the '772 patent by providing, respectively, to Nokia Solutions and

Networks Oy and Nokia Solutions and Networks US and to Nokia Solutions and Networks US the Infringing Products, and/or software or hardware components thereof, that perform or embody a material part of the claimed inventions of the '772 patent, that are known by Nokia Corporation and Nokia Solutions and Networks Oy to be specially made or adapted for use in an infringing manner (including by use of the carrier scheduling/assignment scheme described above), and are not staple articles, nor have substantial non-infringing uses. Nokia Corporation and Nokia Solutions and Networks Oy have known their subsidiaries infringe at least Claims 5-17 of the '772 patent by offering for sale, selling, making, and using the Infringing Products and/or software or hardware components thereof to practice these claims at latest as a result of BlackBerry filing and serving the original complaint in this action (ECF Nos. 1, 5, 6, 8).

237. Nokia's infringement has been, and continues to be, willful and deliberate, and has caused substantial damage to BlackBerry. In spite of Nokia's knowledge of the '772 patent, Nokia has continued making, using, offering for sale/lease, and/or selling or leasing in the United States, and/or importing into the United States, the Infringing Products that are compliant with the LTE Standards (including the carrier scheduling/assignment scheme described above), without a license from BlackBerry. In spite of Nokia's knowledge of the '772 patent, Nokia has continued its conduct constituting induced infringement and contributory infringement of that patent. In committing acts of direct and indirect infringement, Nokia has committed egregious misconduct including, for example, acting despite knowing that its actions constituted infringement of the valid '772 patent, or recklessly disregarding the fact that its actions constituted an unjustifiably high risk of infringement of the valid and enforceable '772 patent. Nokia's willful and deliberate infringement warrants an award of enhanced damages.

**EIGHTH CLAIM FOR RELIEF
(INFRINGEMENT OF UNITED STATES PATENT NO. 8,897,192)**

238. BlackBerry realleges and incorporates by reference the allegations of paragraphs 1-237 of this Amended Complaint.

The '192 Patent

239. The '192 patent is directed to, among other things, a base station comprising “one or more processors configured to: configure a mobile device to operate in a discontinuous reception (DRX) mode” that includes “DRX sleep periods and DRX awake periods,” wherein the mobile device monitors “a plurality of sub-frames” in a “plurality of downlink layer 1 control channel elements (CCEs),” and the base station “transmit[s] signaling comprising a DRX control parameter that indicates a first of said DRX awake periods.” (Exhibit H, '192 patent, Claim 8.) The '192 patent is also directed to a “computer program product” comprising computer readable instructions to perform “configuring a mobile device to operate in a discontinuous reception (DRX) mode” that includes “DRX sleep periods and DRX awake periods,” wherein the mobile device monitors a “plurality of downlink layer 1 control channel elements (CCEs)” in “a plurality of sub-frames” and to perform “transmitting, by a network, signaling comprising a DRX control parameter that indicates a first of said DRX awake periods.” (*Id.*, Claim 15.)

240. The '192 patent discloses an apparatus comprising “a DRX (discontinuous reception) controller that determines discontinuous reception control parameters . . . indicating periods during which the mobile device will have its receiver powered on once discontinuous reception control is active; the DRX controller being further configured to determine a first of said periods during which the mobile device will have its receiver powered on and after which discontinuous reception control will be active.” (*Id.* at 2:45-62.) The '192 patent also discloses “computer readable media having computer executable instructions stored thereon, for execution

by a wireless device or network device for example, that control the execution of” DRX. (*Id.* at 3:13-16.)

241. The ’192 patent explains that “DRX (discontinuous reception) control refers generally to methods of controlling a mobile device to have discontinuous reception capability so as to reduce batter[y] consumption,” where the mobile device’s receiver will be on during “an awake period” and off during a “sleep period.” (*Id.* at 11:2-8.) Figure 11 illustrates one of the methods for starting DRX control, in which network components such as a base station or eNB “transmits DRX control parameters to the mobile device” that “may include parameters that indicate periods during which the mobile device will have its receiver powered on.” (*Id.* at 11:45-53.)

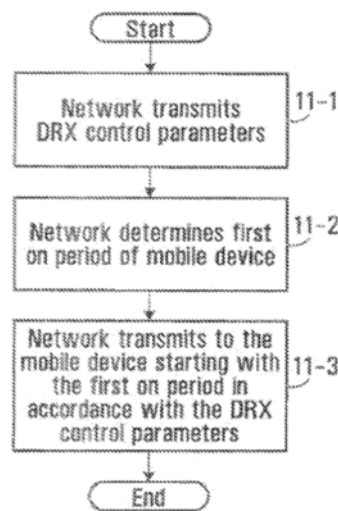

FIG. 11

'192 Patent Allegations

242. Nokia has infringed and is infringing, either literally or under the doctrine of equivalents, at least Claims 8-9, 12-16, and 19-21 of the ’192 patent in violation of 35 U.S.C. § 271 *et seq.*, directly and/or indirectly, by making, using, offering for sale/lease, and/or selling

or leasing in the United States, and/or importing into the United States, without authority or license, the Infringing Products.

243. By complying with and implementing LTE Standards in a commercially viable manner, including the discontinuous reception mode (DRX) feature of the LTE Standards, the Infringing Products and their use are covered by at least Claims 8-9, 12-16, and 19-21 of the '192 patent. The Infringing Products configure a mobile device to operate in a mode wherein the mobile device monitors, for a dynamically-allocated resource, a plurality of downlink layer 1 (i.e., physical layer) control channel (PDCCH) elements in each of a plurality of consecutive sub-frames of the DRX awake period. This is specified, for example, in the following sections of the 3GPP TS 36.331 V8.21.0 specification. Section 5.7 in the MAC Procedure chapter of the 3GPP TS 36.321 V8.12.0 specification describes “Discontinuous Reception (DRX)”:

The UE may be configured by RRC with a DRX functionality that controls the UE’s PDCCH monitoring activity for the UE’s C-RNTI, TPC-PUCCH-RNTI, TPC-PUSCH-RNTI and Semi-Persistent Scheduling C-RNTI (if configured). When in RRC_CONNECTED, if DRX is configured, the UE is allowed to monitor the PDCCH discontinuously using the DRX operation specified in this subclause; otherwise the UE monitors the PDCCH continuously. When using DRX operation, the UE shall also monitor PDCCH according to requirements found in other subclauses of this specification. RRC controls DRX operation by configuring the timers *onDurationTimer*, *drx-InactivityTimer*, *drx-RetransmissionTimer* (one per DL HARQ process except for the broadcast process), the *longDRX-Cycle*, the value of the *drxStartOffset* and optionally the *drxShortCycleTimer* and *shortDRX-Cycle*. A HARQ RTT timer per DL HARQ process (except for the broadcast process) is also defined (see subclause 7.7).

244. Section 3.1 of the 3GPP TS 36.321 V8.12.0 specification sets forth the meaning of relevant DRX control information — e.g., “Active Time,” *drx-InactivityTimer*,” and “*onDurationTimer*” — as well as illustrates the DRX cycle in Figure 3.1-1:

DRX Cycle: Specifies the periodic repetition of the On Duration followed by a possible period of inactivity (see figure 3.1-1 below).

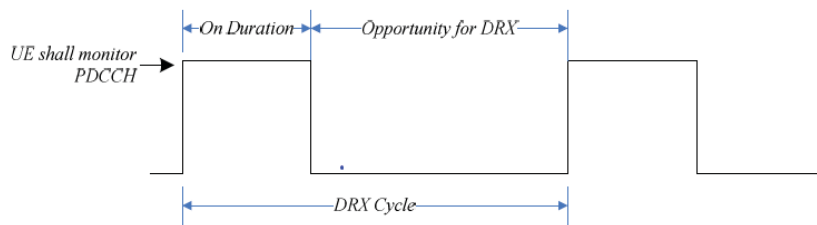

Figure 3.1-1: DRX Cycle

For example, Section 3.1 defines “onDurationTimer” as “[s]pecific[ing] the number of consecutive PDCCH-subframe(s) at the beginning of a DRX Cycle,” during which the mobile device monitors, for a dynamically-allocated resource, a plurality of physical layer downlink control channel elements. Section 3.1 also defines “drxStartOffset” as “[s]pecific[ing] the subframe where the DRX Cycle starts,” which is a transmitted DRX control parameter that indicates a first of the DRX awake periods.

245. Moreover, for example, Sections 6.2 and 6.3 of the 3GPP TS 36.331 V8.21.0 specification set forth the content and syntax of RRC messages to the UE, including a *MAC-MainConfig* information element that contains a DRX-config data structure, and information about the PDCCH is found, *inter alia*, in Section 6.8 of the 3GPP TS 36.211 V8.9.0 specification.

246. Nokia has been, and currently is, an active inducer of infringement of the ’192 patent under 35 U.S.C. § 271(b) and a contributory infringer of the ’192 patent under 35 U.S.C. § 271(c).

247. On information and belief, the Infringing Products implement hardware and/or software configured to perform or embody the patented limitations of at least Claims 8-9, 12-16, and 19-21 of the ’192 patent. For example, the Infringing Products contain hardware and/or software designed to implement discontinuous reception mode (DRX) and “DRX Cycle,” which specifies periodic repetition of the On Duration followed by a possible period of inactivity. On information and belief, the portion of the hardware and/or software that performs or embodies the patented limitations has no substantial non-infringing uses. In particular, because the patented limitations cover features of the LTE Standards that have been widely-used in practice, viz., DRX as described above, the portion of the hardware and/or software of the Infringing

Products that performs or embodies the patented limitations cannot feasibly be removed or disabled.

248. Nokia knew of the '192 patent, or should have known of the '192 patent but was willfully blind to its existence. Nokia knew of the '192 patent and was put on notice of its infringement through a notice letter sent from BlackBerry prior to the filing of the original complaint in this action on February 14, 2017, and as a result of BlackBerry filing and serving the original complaint in this action (ECF Nos. 1, 5, 6, 8). On information and belief, Nokia has had actual knowledge of the '192 patent's family since before the filing of the original complaint in this action at least based on Alcatel-Lucent's knowledge as discussed above in paragraphs 81-82. On information and belief, Nokia developed, commercialized, demonstrated, and/or tested the Infringing Products despite its knowledge of the '192 patent's family through Alcatel-Lucent. Nokia has taken action intending to cause others to directly infringe the '192 patent, including by selling or offering for sale the Infringing Products to third parties in the United States while expressly promoting these products' capability to practice discontinuous reception mode (DRX) according to the LTE Standards, knowing that using these products to practice DRX would constitute direct infringement of the '192 patent. Therefore, on information and belief, Nokia knew or should have known of the '192 patent and of its own infringing acts, or deliberately took steps to avoid learning of those facts.

249. Nokia knowingly and intentionally encourages and aids at least its end-user customers to directly infringe the '192 patent. Nokia's end-user customers directly infringe at least Claims 8-9, 12-16, and 19-21 of the '192 patent by using the Infringing Products in their intended manner (including LTE's discontinuous reception mode described above) to infringe. Nokia induces such infringement by providing the Infringing Products, together with services,

instructions, and technical support to enable and facilitate infringement (including by use of LTE's discontinuous reception mode described above), knowing of, or being willfully blind to the existence of, the '192 patent. On information and belief, Nokia specifically intends that its actions will result in infringement of at least Claims 8-9, 12-16, and 19-21 of the '192 patent, or subjectively believes that its actions will result in infringement of the '192 patent but took deliberate actions to avoid learning of those facts, as set forth above. Nokia has persisted in encouraging the use of the LTE-compliant Infringing Products by its customers in a manner that infringes at least Claims 8-9, 12-16, and 19-21 of the '192 patent (including by use of LTE's discontinuous reception mode described above), without a license from BlackBerry.

250. Nokia contributorily infringes at least Claims 8-9, 12-16, and 19-21 of the '192 patent by providing to its customers the Infringing Products that perform or embody a material part of the claimed inventions of the '192 patent, that are known by Nokia to be specially made or adapted for use in an infringing manner, and are not staple articles with substantial non-infringing uses. The Infringing Products are specially designed to infringe at least Claims 8-9, 12-16, and 19-21 of the '192 patent (including by use of LTE's discontinuous reception mode described above), and the Infringing Products have no substantial non-infringing uses. Nokia has known its customers infringe at least Claims 8-9, 12-16, and 19-21 of the '192 patent by using the Infringing Products to practice these claims at latest as a result of BlackBerry filing and serving the original complaint in this action (ECF Nos. 1, 5, 6, 8).

251. Nokia Corporation knowingly and intentionally encourages and aids at least subsidiaries Nokia Solutions and Networks Oy and Nokia Solutions and Networks US to directly infringe the '192 patent. Nokia Solutions and Networks Oy knowingly and intentionally encourages and aids at least subsidiaries Nokia Solutions and Networks US to directly infringe

the '192 patent. Nokia Solutions and Networks Oy and Nokia Solutions and Networks US directly infringe at least Claims 8-9, 12-16, and 19-21 of the '192 patent at least by offering for sale, selling, making, and using the Infringing Products in the United States (including those incorporating LTE's discontinuous reception mode described above). Nokia Corporation and Nokia Solutions and Networks Oy induce such direct infringement by encouraging, aiding, technically supporting, and instructing their subsidiaries to sell, offer for sale, make, and use the Infringing Products in the United States (including those incorporating LTE's discontinuous reception mode described above). Nokia Corporation and Nokia Solutions and Networks Oy further induce such direct infringement by encouraging, aiding, technically supporting, and instructing their subsidiaries to design and configure the Infringing Products so that they comply with the LTE standards (including LTE's discontinuous reception mode described above) in a manner that infringes at least Claims 8-9, 12-16, and 19-21 of the '192 patent. On information and belief, Nokia Corporation and Nokia Solutions and Networks Oy specifically intend that their actions will result in infringement of at least Claims 8-9, 12-16, and 19-21 of the '192 patent, or subjectively believes that their actions will result in infringement of the '192 patent but took deliberate actions to avoid learning of those facts, as set forth above. Nokia Corporation and Nokia Solutions and Networks Oy have persisted in encouraging the use of the LTE-compliant Infringing Products by their subsidiaries in a manner that infringes at least Claims 8-9, 12-16, and 19-21 of the '192 patent (including by incorporating LTE's discontinuous reception mode described above), without a license from BlackBerry.

252. Nokia Corporation and Nokia Solutions and Networks Oy contributorily infringe at least Claims 8-9, 12-16, and 19-21 of the '192 patent by providing, respectively, to Nokia Solutions and Networks Oy and Nokia Solutions and Networks US and to Nokia Solutions and

Networks US the Infringing Products, and/or software or hardware components thereof, that perform or embody a material part of the claimed inventions of the '192 patent, that are known by Nokia Corporation and Nokia Solutions and Networks Oy to be specially made or adapted for use in an infringing manner (including by use of LTE's discontinuous reception mode described above), and are not staple articles, nor have substantial non-infringing uses. Nokia Corporation and Nokia Solutions and Networks Oy have known their subsidiaries infringe at least Claims 8-9, 12-16, and 19-21 of the '192 patent by offering for sale, selling, making, and using the Infringing Products and/or software or hardware components thereof to practice these claims at latest as a result of BlackBerry filing and serving the original complaint in this action (ECF Nos. 1, 5, 6, 8).

253. Nokia's infringement has been, and continues to be, willful and deliberate, and has caused substantial damage to BlackBerry. In spite of Nokia's knowledge of the '192 patent, Nokia has continued making, using, offering for sale/lease, and/or selling or leasing in the United States, and/or importing into the United States, the Infringing Products that are compliant with the LTE Standards (including LTE's discontinuous reception mode described above), without a license from BlackBerry. In spite of Nokia's knowledge of the '192 patent, Nokia has continued its conduct constituting induced infringement and contributory infringement of that patent. In committing acts of direct and indirect infringement, Nokia has committed egregious misconduct including, for example, acting despite knowing that its actions constituted infringement of the valid '192 patent, or recklessly disregarding the fact that its actions constituted an unjustifiably high risk of infringement of the valid and enforceable '192 patent. Nokia's willful and deliberate infringement warrants an award of enhanced damages.

**NINTH CLAIM FOR RELIEF
(INFRINGEMENT OF UNITED STATES PATENT NO. 9,125,202)**

254. BlackBerry realleges and incorporates by reference the allegations of paragraphs 1-253 of this Amended Complaint.

The '202 Patent

255. The '202 patent is directed to, among other things, methods for generating “a common pilot signal, first user data, and second user data,” transmitting, “within a timeslot and across a sector, the common pilot signal using a first subset of orthogonal resources,” transmitting, “within the timeslot, a first spatially-separable signal comprising the first user data, using a second subset of orthogonal resources,” and transmitting, “within the timeslot, a second spatially-separable signal comprising the second user data, using at least a part of the second subset of orthogonal resources,” wherein “the first and second subsets of orthogonal resources are respective first and second subsets of tones within an Orthogonal Frequency Division Multiplexing (OFDM) system.” (Exhibit I, '202 patent, Claim 1.) The '202 patent is also directed to an OFDM base station comprising a processor that causes the performance of generating “a common pilot signal, first user data, and second user data,” transmitting “the common pilot signal using a first subset of orthogonal resources,” transmitting “a first spatially-separable signal comprising the first user data, using a second subset of orthogonal resources,” and transmitting “a second spatially-separable signal comprising the second user data, using at least a part of the second subset of orthogonal resources,” wherein “the first and second subsets of orthogonal resources are respective first and second subsets of tones within an Orthogonal Frequency Division Multiplexing (OFDM) system.” (*Id.*, Claim 11.)

256. The '202 patent explains that, in digital cellular systems, “it is desired to have as few base stations as possible” because of expense, need for planning permission, and lack of

availability; therefore, “each base station should ideally have as large a capacity as possible in order to service as large a number of end user equipments as possible.” (*Id.* at 1:23-29.) One method of increasing capacity involves the “replacement of a sector wide beam width antenna with an antenna array that allows the formation of a number of narrower beams that cover the area of the original wide beam,” but “[s]ignificant optimization” was needed. (*Id.* at 1:48-55.)

257. The '202 patent relates to “a cellular communication system in which each cell sector is covered by a multi-beam antenna array in which coded timeslots, which may be orthogonally coded timeslots, are transmitted on each beam in the sector wherein the codes are re-used in the beams in the sector to simultaneously send different data traffic to end user equipments on the different beams.” (*Id.* at 1:59-65.) “A pilot channel common to all the beams is sent simultaneously to end user equipments.” (*Id.* at 1:65-67.)

258. The '202 patent describes an embodiment in which “[o]ne pilot signal is common to the sector,” which “is achieved by transmitting the same pilot signal on all the narrow beams (10, 12, 14) simultaneously to effectively create a pilot signal which is transmitted on the sector wide beam (44).” (*Id.* at 7:12-16.) For example, Figure 2A shows “three timeslots [that] are transmitted on the three beams (10, 12, 14) simultaneously,” and “[e]ach time slot is typically spilt into 32 orthogonal Walsh codes” that “are re-used in each beam.” (*Id.* at 7:36-41.)

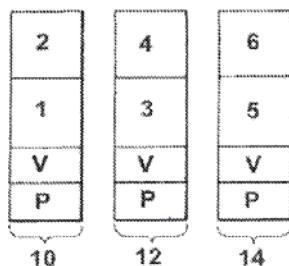

Fig. 2A

259. In this example, a subset P (2 of the 32 orthogonal Walsh codes) “are allocated for the overhead channels,” and “the same pilot signal is sent on an overhead channel simultaneously on all the narrow beams in the sector.” (*Id.* at 7:41-46.) A second sub-set V (2 of the 32 orthogonal Walsh codes) are “allocated for power-controlled channels, such as voice channels.” (*Id.* at 7:47-49.) “[T]he same voice signal is sent on the same voice channel on one, two or all three of the narrow beams in the sector,” but “the code the voice traffic is assigned to is not re-used elsewhere in the sector.” (*Id.* at 7:53-58.) The “remaining Walsh codes, for example 28 of the 32 used Walsh codes[,] are allocated to data traffic.” (*Id.* at 7:62-63.)

260. As shown in Figure 2A, “it is possible to simultaneously, i.e. within the same time slot period, transmit data to six mobile stations 1 to 6 within the sector covered by the three beams (10, 12, 14).” (*Id.* at 8:5-8.) For example, “data traffic to mobile station 1 is transmitted in a first block of the Walsh codes (identified by ‘1’ in FIG. 2a) in the time slot on beam (10) and data traffic to mobile station 2 is transmitted in a second block of the Walsh codes (identified by ‘2’ in FIG. 2a) in the time slot on beam (10).” (*Id.* at 8:10-15.)

261. The above example is described in relation to a sub-set of Walsh codes for CDMA based systems. However, another example “could be defined as tones in Orthogonal Frequency Division Multiplexed (OFDM) or frequencies in Frequency Division Multiple Access/Time Division Multiple Access systems. That is, the set of tones or frequencies allocated to the system could be split into two sub-sets of tones or frequencies with the division between the sub-sets always set differently in adjacent beams.” (*Id.* at 12:38-46.)

'202 Patent Allegations

262. Nokia has infringed and is infringing, either literally or under the doctrine of equivalents, at least Claims 1-7 and 10-15 of the '202 patent in violation of 35 U.S.C. § 271 *et*

seq., directly and/or indirectly, by making, using, offering for sale/lease, and/or selling or leasing in the United States, and/or importing into the United States, without authority or license, the Infringing Products.

263. On information and belief, Nokia makes, offers for sale, sells, uses, deploys, and configures in the United States Infringing Products that use Downlink Multi-user Multiple-Input Multiple-Output (DL MU-MIMO), in wireless communication networks in compliance with LTE Standards, which Infringing Products, and/or their use, are covered by at least Claims 1-7 and 10-15 of the '202 patent.

264. For example, Section 6.10.1 of the 3GPP TS 36.211 V9.1.0 specification and subsequent versions describe a common pilot signal, a “[c]ell-specific reference signal[] . . . transmitted in all downlink subframes in a cell.” Such a pilot signal is illustrated by the blue-shaded resource elements of Figure 6.10.1.2-1 (excerpt below) of the 3GPP TS 36.211 V9.1.0 specification, which relate to the downlink reference signals for normal cyclic prefix.

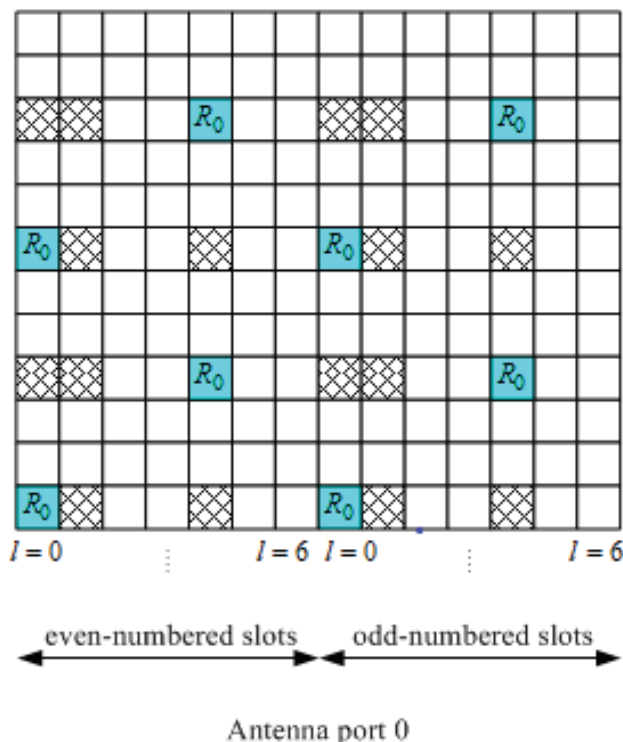

265. In addition, Section 7.1 of the 3GPP TS 36.213 specification provides information on transmission modes used for DL MU-MIMO — Transmission Modes 5, 8, 9, and 10 — by which a subset of available orthogonal resources are used to send user data to two or more users in an LTE network via DL MU-MIMO. For example, Section 7.1 of the 3GPP TS 36.213 V9.3.0 specification states that “the UE is semi-statically configured via higher layer signalling to receive PDSCH data transmissions signalled via PDCCH according to one of eight transmission modes, denoted mode 1 to mode 8.” These are listed on Table 7.1-5 in the 3GPP TS 36.213 V9.3.0 specification, excerpted below, including Transmission Modes 5 and 8:

Table 7.1-5: PDCCH and PDSCH configured by C-RNTI

Transmission mode	DCI format	Search Space	Transmission scheme of PDSCH corresponding to PDCCH
Mode 1	DCI format 1A	Common and UE specific by C-RNTI	Single-antenna port, port 0 (see subclause 7.1.1)
	DCI format 1	UE specific by C-RNTI	Single-antenna port, port 0 (see subclause 7.1.1)
Mode 2	DCI format 1A	Common and UE specific by C-RNTI	Transmit diversity (see subclause 7.1.2)
	DCI format 1	UE specific by C-RNTI	Transmit diversity (see subclause 7.1.2)
Mode 3	DCI format 1A	Common and UE specific by C-RNTI	Transmit diversity (see subclause 7.1.2)
	DCI format 2A	UE specific by C-RNTI	Large delay CDD (see subclause 7.1.3) or Transmit diversity (see subclause 7.1.2)
Mode 4	DCI format 1A	Common and UE specific by C-RNTI	Transmit diversity (see subclause 7.1.2)
	DCI format 2	UE specific by C-RNTI	Closed-loop spatial multiplexing (see subclause 7.1.4) or Transmit diversity (see subclause 7.1.2)
Mode 5	DCI format 1A	Common and UE specific by C-RNTI	Transmit diversity (see subclause 7.1.2)
	DCI format 1D	UE specific by C-RNTI	Multi-user MIMO (see subclause 7.1.5)
Mode 6	DCI format 1A	Common and UE specific by C-RNTI	Transmit diversity (see subclause 7.1.2)
	DCI format 1B	UE specific by C-RNTI	Closed-loop spatial multiplexing (see subclause 7.1.4) using a single transmission layer
Mode 7	DCI format 1A	Common and UE specific by C-RNTI	If the number of PBCH antenna ports is one, Single-antenna port, port 0 is used (see subclause 7.1.1), otherwise Transmit diversity (see subclause 7.1.2)
	DCI format 1	UE specific by C-RNTI	Single-antenna port, port 5 (see subclause 7.1.1)
Mode 8	DCI format 1A	Common and UE specific by C-RNTI	If the number of PBCH antenna ports is one, Single-antenna port, port 0 is used (see subclause 7.1.1), otherwise Transmit diversity (see subclause 7.1.2)
	DCI format 2B	UE specific by C-RNTI	Dual layer transmission; port 7 and 8 (see subclause 7.1.5A) or single-antenna port; port 7 or 8 (see subclause 7.1.1)

266. As indicated in the “Transmission scheme” column of Table 7.1-5 above, Sections 7.1.5 and 7.1.5A of the 3GPP TS 36.213 V9.3.0 specification and subsequent versions describe, respectively, the “Multi-user MIMO scheme” for Transmission Mode 5 and the “Dual layer scheme” for Transmission Mode 8:

7.1.5 Multi-user MIMO scheme

For the multi-user MIMO transmission scheme of the PDSCH, the UE may assume that an eNB transmission on the PDSCH would be performed on one layer and according to Section 6.3.4.2.1 of [3]. The $\delta_{\text{power-offset}}$ dB value signalled on PDCCH with DCI format 1D using the downlink power offset field is given in Table 7.1.5-1.

Table 7.1.5-1: Mapping of downlink power offset field in DCI format 1D to the $\delta_{\text{power-offset}}$ value.

Downlink power offset field	$\delta_{\text{power-offset}}$ [dB]
0	$-10\log_{10}(2)$
1	0

7.1.5A Dual layer scheme

For the dual layer transmission scheme of the PDSCH, the UE may assume that an eNB transmission on the PDSCH would be performed with two transmission layers on antenna ports 7 and 8 as defined in Section 6.3.4.4 of [3].

267. In Releases 10 and 11, the 3GPP TS 36.213 specification was updated to include support for additional transmission modes, Transmission Modes 9 and 10. Accordingly, for example, Section 7.1 of the 3GPP TS 36.213 V11.10.0 specification states that “the UE is semi-statically configured via higher layer signalling to receive PDSCH data transmissions signalled via PDCCH/EPDCCH according to one of ten transmission modes, denoted mode 1 to mode 10.” These are listed on updated Table 7.1-5 in the 3GPP TS 36.213 V11.10.0 specification, excerpted below, including Transmission Modes 5, 8, 9, and 10:

Table 7.1-5: PDCCH and PDSCH configured by C-RNTI

Transmission mode	DCI format	Search Space	Transmission scheme of PDSCH corresponding to PDCCH
Mode 1	DCI format 1A	Common and UE specific by C-RNTI	Single-antenna port, port 0 (see subclause 7.1.1)
	DCI format 1	UE specific by C-RNTI	Single-antenna port, port 0 (see subclause 7.1.1)
Mode 2	DCI format 1A	Common and UE specific by C-RNTI	Transmit diversity (see subclause 7.1.2)
	DCI format 1	UE specific by C-RNTI	Transmit diversity (see subclause 7.1.2)
Mode 3	DCI format 1A	Common and UE specific by C-RNTI	Transmit diversity (see subclause 7.1.2)
	DCI format 2A	UE specific by C-RNTI	Large delay CDD (see subclause 7.1.3) or Transmit diversity (see subclause 7.1.2)
Mode 4	DCI format 1A	Common and UE specific by C-RNTI	Transmit diversity (see subclause 7.1.2)
	DCI format 2	UE specific by C-RNTI	Closed-loop spatial multiplexing (see subclause 7.1.4) or Transmit diversity (see subclause 7.1.2)
Mode 5	DCI format 1A	Common and UE specific by C-RNTI	Transmit diversity (see subclause 7.1.2)
	DCI format 1D	UE specific by C-RNTI	Multi-user MIMO (see subclause 7.1.5)
Mode 6	DCI format 1A	Common and UE specific by C-RNTI	Transmit diversity (see subclause 7.1.2)
	DCI format 1B	UE specific by C-RNTI	Closed-loop spatial multiplexing (see subclause 7.1.4) using a single transmission layer
Mode 7	DCI format 1A	Common and UE specific by C-RNTI	If the number of PBCH antenna ports is one, Single-antenna port, port 0 is used (see subclause 7.1.1), otherwise Transmit diversity (see subclause 7.1.2)
	DCI format 1	UE specific by C-RNTI	Single-antenna port, port 5 (see subclause 7.1.1)
Mode 8	DCI format 1A	Common and UE specific by C-RNTI	If the number of PBCH antenna ports is one, Single-antenna port, port 0 is used (see subclause 7.1.1), otherwise Transmit diversity (see subclause 7.1.2)
	DCI format 2B	UE specific by C-RNTI	Dual layer transmission, port 7 and 8 (see subclause 7.1.5A) or single-antenna port, port 7 or 8 (see subclause 7.1.1)
Mode 9	DCI format 1A	Common and UE specific by C-RNTI	<ul style="list-style-type: none"> Non-MBSFN subframe: If the number of PBCH antenna ports is one, Single-antenna port, port 0 is used (see subclause 7.1.1), otherwise Transmit diversity (see subclause 7.1.2) MBSFN subframe: Single-antenna port, port 7 (see subclause 7.1.1)
	DCI format 2C	UE specific by C-RNTI	Up to 8 layer transmission, ports 7-14 (see subclause 7.1.5B) or single-antenna port, port 7 or 8 (see subclause 7.1.1)
Mode 10	DCI format 1A	Common and UE specific by C-RNTI	<ul style="list-style-type: none"> Non-MBSFN subframe: If the number of PBCH antenna ports is one, Single-antenna port, port 0 is used (see subclause 7.1.1), otherwise Transmit diversity (see subclause 7.1.2) MBSFN subframe: Single-antenna port, port 7 (see subclause 7.1.1)
	DCI format 2D	UE specific by C-RNTI	Up to 8 layer transmission, ports 7-14 (see subclause 7.1.5B) or single-antenna port, port 7 or 8 (see subclause 7.1.1)

268. As indicated in the “Transmission scheme” column of Table 7.1-5 above, Section 7.1.5B of the 3GPP TS 36.213 V11.10.0 specification and subsequent versions describes the Multi-user MIMO scheme for “Up to 8 layer transmission” for Transmission Modes 9 and 10:

7.1.5B Up to 8 layer transmission scheme

For the up to 8 layer transmission scheme of the PDSCH, the UE may assume that an eNB transmission on the PDSCH would be performed with up to 8 transmission layers on antenna ports 7 - 14 as defined in subclause 6.3.4.4 of [3].

269. Section 5 of 3GPP TS 36.300 V9.7.0 and subsequent versions describe the PDCCH for the LTE physical layer, which “informs the UE about the resource allocation of PCH and DL-SCH, and Hybrid ARQ information related to DL-SCH.”

270. Sections 11 and 16.1.4 of 3GPP TS 36.300 V9.7.0 and subsequent versions describe the scheduler that allocates OFDM resources on a time slot basis and dynamic resource allocation of resource blocks:

In order to utilise the SCH resources efficiently, a scheduling function is used in MAC. In this subclause, an overview of the scheduler is given in terms of scheduler operation, signalling of scheduler decisions, and measurements to support scheduler operation.

11.1 Basic Scheduler Operation

MAC in eNB includes dynamic resource schedulers that allocate physical layer resources for the DL-SCH and UL-SCH transport channels. Different schedulers operate for the DL-SCH and UL-SCH.

The scheduler should take account of the traffic volume and the QoS requirements of each UE and associated radio bearers, when sharing resources between UEs. Only “per UE” grants are used to grant the right to transmit on the UL-SCH (i.e. there are no “per UE per RB” grants).

Schedulers may assign resources taking account the radio conditions at the UE identified through measurements made at the eNB and/or reported by the UE.

Radio resource allocations can be valid for one or multiple TTIs.

Resource assignment consists of physical resource blocks (PRB) and MCS. Allocations for time periods longer than one TTI might also require additional information (allocation time, allocation repetition factor...).

11.1.1 Downlink Scheduling

In the downlink, E-UTRAN can dynamically allocate resources (PRBs and MCS) to UEs at each TTI via the C-RNTI on PDCCH(s). A UE always monitors the PDCCH(s) in order to find possible allocation when its downlink reception is enabled (activity governed by DRX when configured).

In addition, E-UTRAN can allocate semi-persistent downlink resources for the first HARQ transmissions to UEs:

- RRC defines the periodicity of the semi-persistent downlink grant;
- PDCCH indicates whether the downlink grant is a semi-persistent one i.e. whether it can be implicitly reused in the following TTIs according to the periodicity defined by RRC.

When required, retransmissions are explicitly signalled via the PDCCH(s). In the sub-frames where the UE has semi-persistent downlink resource, if the UE cannot find its C-RNTI on the PDCCH(s), a downlink transmission according to the semi-persistent allocation that the UE has been assigned in the TTI is assumed. Otherwise, in the sub-frames where the UE has semi-persistent downlink resource, if the UE finds its C-RNTI on the PDCCH(s), the PDCCH allocation overrides the semi-persistent allocation for that TTI and the UE does not decode the semi-persistent resources.

...

16.1.4 Dynamic Resource Allocation (DRA) - Packet Scheduling (PS)

The task of dynamic resource allocation (DRA) or packet scheduling (PS) is to allocate and de-allocate resources (including buffer and processing resources and resource blocks (i.e. chunks)) to user and control plane packets. DRA involves several sub-tasks, including the selection of radio bearers whose packets are to be scheduled and managing the necessary resources (e.g. the power levels or the specific resource blocks used). PS typically takes into account the QoS requirements associated with the radio bearers, the channel quality information for UEs, buffer status, interference situation, etc. DRA may also take into account restrictions or preferences on some of the available resource blocks or resource block sets due to inter-cell interference coordination considerations.

DRA is located in the eNB.

271. For example, Nokia's Infringing Products support Transmission Modes 5, 8, 9, and 10 in which beamforming antenna systems transmit at least two spatially separable signals using the orthogonal resources of the OFDM frame in a manner that practices at least Claims 1-7 and 10-15 of the '202 patent. Moreover, for example, Nokia's Flexi Radio Antenna System and newer AirScale Active Antennas provide for spatially separable beams within a sector.

272. Nokia has been, and currently is, an active inducer of infringement of the '202 patent under 35 U.S.C. § 271(b) and a contributory infringer of the '202 patent under 35 U.S.C. § 271(c).

273. On information and belief, the Infringing Products implement hardware and/or software configured to perform or embody the patented limitations of at least Claims 1-7 and 10-15 of the '202 patent. For example, the Infringing Products contain hardware and/or software designed to implement Multi-user Multiple-Input Multiple-Output in downlink direction from base station to mobile unit as described above. On information and belief, the portion of the hardware and/or software that performs or embodies the patented limitations has no substantial non-infringing uses. In particular, because the patented limitations cover features of the LTE Standards that have been widely-used in practice, viz., DL MU-MIMO as described above, the portion of the hardware and/or software of the Infringing Products that performs or embodies the patented limitations cannot feasibly be removed or disabled.

274. Nokia knew of the '202 patent, or should have known of the '202 patent but was willfully blind to its existence. Nokia knew of the '202 patent and was put on notice of its

infringement through a notice letter sent from BlackBerry prior to the filing of the original complaint in this action on February 14, 2017, and as a result of BlackBerry filing and serving the original complaint in this action (ECF Nos. 1, 5, 6, 8). On information and belief, Nokia had actual knowledge of the application that led to the issuance of the '202 patent since at least as early as June 19, 2009, and at the latest by July 24, 2009. On information and belief, Nokia has had actual knowledge of the '202 patent's family at least based on Alcatel's/ Alcatel-Lucent's knowledge as discussed above in paragraphs 83-84. On information and belief, Nokia developed, commercialized, demonstrated, and/or tested the Infringing Products despite its evaluation and knowledge of the Nortel patent portfolio, including the application that led to the issuance of the '202 patent, and its knowledge of the '202 patent's family through Alcatel/Alcatel-Lucent. Nokia has taken action intending to cause others to directly infringe the '202 patent, including by selling or offering for sale the Infringing Products to third parties in the United States while expressly promoting these products' capability to practice the LTE Standards (including the DL MU-MIMO features described above), knowing that using these products to practice the LTE Standards would constitute direct infringement of the '202 patent. Therefore, on information and belief, Nokia knew or should have known of the '202 patent and of its own infringing acts, or deliberately took steps to avoid learning of those facts.

275. Nokia knowingly and intentionally encourages and aids at least its end-user customers to directly infringe the '202 patent. Nokia's end-user customers directly infringe at least Claims 1-7 and 10-15 of the '202 patent by using the Infringing Products in their intended manner (including the DL MU-MIMO features described above) to infringe. Nokia induces such infringement by providing the Infringing Products, together with services, instructions, and technical support to enable and facilitate infringement (including by use of the DL MU-MIMO

features described above), knowing of, or being willfully blind to the existence of, the '202 patent. On information and belief, Nokia specifically intends that its actions will result in infringement of at least Claims 1-7 and 10-15 of the '202 patent, or subjectively believes that its actions will result in infringement of the '202 patent but took deliberate actions to avoid learning of those facts, as set forth above. Nokia has persisted in encouraging the use of the LTE-compliant Infringing Products by its customers in a manner that infringes at least Claims 1-7 and 10-15 of the '202 patent (including by use of the DL MU-MIMO features described above), without a license from BlackBerry.

276. Nokia contributorily infringes at least Claims 1-7 and 10-15 of the '202 patent by providing to its customers the Infringing Products that perform or embody a material part of the claimed inventions of the '202 patent, that are known by Nokia to be specially made or adapted for use in an infringing manner, and are not staple articles with substantial non-infringing uses. The Infringing Products are specially designed to infringe at least Claims 1-7 and 10-15 of the '202 patent (including by use of the DL MU-MIMO features described above), and the Infringing Products have no substantial non-infringing uses. The Infringing Products are specially designed to infringe at least Claims 1-7 and 10-15 of the '202 patent, and the Infringing Products have no substantial non-infringing uses. Nokia has known its customers infringe at least Claims 1-7 and 10-15 of the '202 patent by using the Infringing Products to practice these claims at latest as a result of BlackBerry filing and serving the original complaint in this action (ECF Nos. 1, 5, 6, 8).

277. Nokia Corporation knowingly and intentionally encourages and aids at least subsidiaries Nokia Solutions and Networks Oy and Nokia Solutions and Networks US to directly infringe the '202 patent. Nokia Solutions and Networks Oy knowingly and intentionally

encourages and aids at least subsidiaries Nokia Solutions and Networks US to directly infringe the '202 patent. Nokia Solutions and Networks Oy and Nokia Solutions and Networks US directly infringe at least Claims 1-7 and 10-15 of the '202 patent at least by offering for sale, selling, making, and using the Infringing Products in the United States (including those incorporating the DL MU-MIMO features described above). Nokia Corporation and Nokia Solutions and Networks Oy induce such direct infringement by encouraging, aiding, technically supporting, and instructing their subsidiaries to sell, offer for sale, make, and use the Infringing Products in the United States (including those incorporating the DL MU-MIMO features described above). Nokia Corporation and Nokia Solutions and Networks Oy further induce such direct infringement by encouraging, aiding, technically supporting, and instructing their subsidiaries to design and configure the Infringing Products so that they comply with the LTE standards (including the DL MU-MIMO features described above) in a manner that infringes at least Claims 1-7 and 10-15 of the '202 patent. On information and belief, Nokia Corporation and Nokia Solutions and Networks Oy specifically intend that their actions will result in infringement of at least Claims 1-7 and 10-15 of the '202 patent, or subjectively believes that their actions will result in infringement of the '202 patent but took deliberate actions to avoid learning of those facts, as set forth above. Nokia Corporation and Nokia Solutions and Networks Oy have persisted in encouraging the use of the LTE-compliant Infringing Products by their subsidiaries in a manner that infringes at least Claims 1-7 and 10-15 of the '202 patent (including by incorporating the DL MU-MIMO features described above), without a license from BlackBerry.

278. Nokia Corporation and Nokia Solutions and Networks Oy contributorily infringe at least Claims 1-7 and 10-15 of the '202 patent by providing, respectively, to Nokia Solutions

and Networks Oy and Nokia Solutions and Networks US and to Nokia Solutions and Networks US the Infringing Products, and/or software or hardware components thereof, that perform or embody a material part of the claimed inventions of the '202 patent, that are known by Nokia Corporation and Nokia Solutions and Networks Oy to be specially made or adapted for use in an infringing manner (including by use of the DL MU-MIMO features described above), and are not staple articles, nor have substantial non-infringing uses. Nokia Corporation and Nokia Solutions and Networks Oy have known their subsidiaries infringe at least Claims 1-7 and 10-15 of the '202 patent by offering for sale, selling, making, and using the Infringing Products and/or software or hardware components thereof to practice these claims at latest as a result of BlackBerry filing and serving the original complaint in this action (ECF Nos. 1, 5, 6, 8).

279. Nokia's infringement has been, and continues to be, willful and deliberate, and has caused substantial damage to BlackBerry. In spite of Nokia's knowledge of the '202 patent, Nokia has continued making, using, offering for sale/lease, and/or selling or leasing in the United States, and/or importing into the United States, the Infringing Products that are compliant with the LTE Standards (including the DL MU-MIMO features described above), without a license from BlackBerry. In spite of Nokia's knowledge of the '202 patent, Nokia has continued its conduct constituting induced infringement and contributory infringement of that patent. In committing acts of direct and indirect infringement, Nokia has committed egregious misconduct including, for example, acting despite knowing that its actions constituted infringement of the valid '202 patent, or recklessly disregarding the fact that its actions constituted an unjustifiably high risk of infringement of the valid and enforceable '202 patent. Nokia's willful and deliberate infringement warrants an award of enhanced damages.

**TENTH CLAIM FOR RELIEF
(INFRINGEMENT OF UNITED STATES PATENT NO. 7,529,683)**

280. BlackBerry realleges and incorporates by reference the allegations of paragraphs 1-279 of this Amended Complaint.

The '683 Patent

281. The '683 patent relates to technology for “transitioning between states and modes of operation in a wireless network such as for example, a Universal Mobile Telecommunication System (UMTS) network.” (Exhibit K, '683 patent, 1:20-25.) The '683 patent, among other things, is directed to a method that includes: “sending a system information message to a user equipment, the system information message including an inhibit transition indication, the inclusion of the inhibit transition indication in the system information message indicating that the user equipment may send signaling connection release indication messages with a cause; receiving from the user equipment a signaling connection release indication message having a cause set to UE Requested PS Data session end; and sending to the user equipment a message to initiate a state transition from a first radio resource control (RRC) state to a battery-efficient RRC state or mode.” (*Id.*, Claim 1.) The '683 patent is also directed to a network element configured to carry out the above method. (*See id.*, Claim 13.)

282. Before the '683 patent, transitions between RRC modes of operation and states in UMTS networks were typically determined by the UMTS network based on data activity or inactivity. (*See id.* at 2:18-20.) This could cause problems because a UE that “completed its data transaction and is not expecting any further data exchange [would] still wait[] for the network to move it to the correct state.” (*Id.* at 2:36-39.) The UE could “be forced to stay in a higher data rate state or mode than what is required, possibly resulting in decreased battery life for the mobile station and also possibly resulting in wasted network resources due to the fact that

the radio resources are unnecessarily being kept occupied and are thus not available for another user.” (*Id.* at 2:51-60.)

283. A method existed for mobile phones to send a signaling release indication to the UMTS network, but that method risked inundating the UMTS network with release indication messages. (*Id.* at 2:61-3:3.)

284. The '683 patent discloses improved methods for transitioning from a connected mode to a more battery-efficient or radio resource-efficient state or mode while providing for decision-making capabilities at the network. (*Id.* at 4:33-37.) The '683 patent describes an innovative approach that “restricts the UE from sending the transition indication message too frequently and further allows the network to make a determination by relying on messages that are triggered only with a given maximum frequency.” (*Id.* at 6:18-22.) The time duration or frequency can be “determined by a timer whose value is preconfigured, or set by a network (indicated or signaled). If the value is set by a network, it could be conveyed in . . . a System Information Block” as “an information element in those messages.” (*Id.* at 6:22-29.)

'683 Patent Allegations

285. Nokia has infringed and is infringing, either literally or under the doctrine of equivalents, at least Claims 1-23 of the '683 patent in violation of 35 U.S.C. § 271 *et seq.*, directly and/or indirectly, by making, using, offering for sale/lease, and/or selling or leasing in the United States, and/or importing into the United States, without authority or license, the Infringing Products.

286. On information and belief, by complying with UMTS/UTRAN Standards, including those set forth in the 3GPP TS 25.331 specification, the Infringing Products and/or their use are covered by Claims 1-23 of the '683 patent. On information and belief, the

Infringing Products offer the Fast Dormancy feature, which is used to conserve system resources and device power and battery life when a device is inactive by utilizing an inhibit transition indication in a system information message indicating that the user equipment may send a signaling connection release indication, and may also allow the device to reactivate and connect very quickly without unnecessary signaling.

287. Nokia has been, and currently is, an active inducer of infringement of the '683 patent under 35 U.S.C. § 271(b), and a contributory infringer of the '683 patent under 35 U.S.C. § 271(c).

288. On information and belief, the Infringing Products include hardware and/or software configured to perform or embody patented limitations of Claims 1-23 of the '683 patent. For example, the Infringing Products include hardware and/or software configured to send a message to the user equipment to initiate a state transition from a first radio resource control (RRC) state to a battery-efficient RRC state or mode utilizing an inhibit transition indication in a system information message indicating that the user equipment may send a signaling connection release indication. On information and belief, the portion of the hardware and/or software that performs or embodies the patented limitations has no non-infringing uses. In particular, because the patented limitations cover features of the UMTS/UTRAN Standards that have been widely-used in practice, viz., fast dormancy as described above, the portion of the hardware and/or software of the Infringing Products that performs or embodies the patented limitations cannot feasibly be removed or disabled.

289. Nokia knew of the '683 patent, or should have known of the '683 patent but was willfully blind to its existence. Nokia knew of the '683 patent and was put on notice of its infringement through a notice letter sent from BlackBerry prior to the filing of the original

complaint in this action on February 14, 2017, and as a result of BlackBerry filing and serving the original complaint in this action (ECF Nos. 1, 5, 6, 8). On information and belief, Nokia had actual knowledge of the '683 patent since at least as early as the application that resulted in the issuance of the '683 patent was cited by the examiner on March 9, 2015, during Nokia's own patent prosecution as discussed above in paragraphs 86-87. On information and belief, Nokia developed, commercialized, demonstrated, and/or tested the Infringing Products despite its knowledge of the application that led to the issuance of the '683 patent from prosecution of Nokia's own patent application. Nokia has taken action intending to cause others to directly infringe the '683 patent, including by selling or offering for sale the Infringing Products to third parties in the United States while expressly promoting these products' Fast Dormancy feature, knowing that using these products to practice the Fast Dormancy feature would constitute direct infringement of the '683 patent. Therefore, on information and belief, Nokia knew or should have known of the '683 patent and of its own infringing acts, or deliberately took steps to avoid learning of those facts.

290. Nokia knowingly and intentionally encourages and aids at least its end-user customers to directly infringe the '683 patent. Nokia's end-user customers directly infringe at least Claims 1-23 of the '683 patent by using the Infringing Products in their intended manner (including the use of the Fast Dormancy feature described above) to infringe. Nokia induces such infringement by providing the Infringing Products and services, instructions, and technical support to enable and facilitate infringement (including by use of the Fast Dormancy feature described above), knowing of, or being willfully blind to the existence of, the '683 patent. On information and belief, Nokia specifically intends that its actions will result in infringement of at least Claims 1-23 of the '683 patent, or subjectively believes that its actions will result in

infringement of the '683 patent but took deliberate actions to avoid learning of those facts, as set forth above. Nokia has persisted in encouraging the use of the UMTS/UTRAN-compliant Infringing Products by its customers in a manner that infringes at least Claims 1-23 of the '683 patent (including by use of the Fast Dormancy feature described above), without a license from BlackBerry.

291. Nokia contributorily infringes at least Claims 1-23 of the '683 patent by providing to its customers the Infringing Products, and/or software or hardware components thereof, that perform or embody a material part of the claimed inventions of the '683 patent, that are known by Nokia to be specially made or adapted for use in an infringing manner (including by use of the Fast Dormancy feature described above), that are not staple articles, and that have no substantial non-infringing uses. In particular, on information and belief, because the patented limitations cover features of the UMTS/UTRAN Standards that have been widely-used in practice (including the Fast Dormancy feature described above), the portion of the hardware and/or software of the Infringing Products that performs or embodies the patented limitations of at least Claims 1-23 cannot feasibly be removed or disabled. Nokia has known its customers infringe at least Claims 1-23 of the '683 patent by using the Infringing Products, and/or software or hardware components thereof, to practice these claims at latest as a result of BlackBerry filing and serving the original complaint in this action (ECF Nos. 1, 5, 6, 8).

292. Nokia Corporation knowingly and intentionally encourages and aids at least subsidiaries Nokia Solutions and Networks Oy and Nokia Solutions and Networks US to directly infringe the '683 patent. Nokia Solutions and Networks Oy knowingly and intentionally encourages and aids at least subsidiaries Nokia Solutions and Networks US to directly infringe the '683 patent. Nokia Solutions and Networks Oy and Nokia Solutions and Networks US

directly infringe at least Claims 1-23 of the '683 patent at least by offering for sale, selling, making, and using the Infringing Products in the United States (including those incorporating the Fast Dormancy feature described above). Nokia Corporation and Nokia Solutions and Networks Oy induce such direct infringement by encouraging, aiding, technically supporting, and instructing their subsidiaries to sell, offer for sale, make, and use the Infringing Products in the United States (including those incorporating the Fast Dormancy feature described above). Nokia Corporation and Nokia Solutions and Networks Oy further induce such direct infringement by encouraging, aiding, technically supporting, and instructing their subsidiaries to design and configure the Infringing Products so that they comply with the LTE standards (including the Fast Dormancy feature described above) in a manner that infringes at least Claims 1-23 of the '683 patent. On information and belief, Nokia Corporation and Nokia Solutions and Networks Oy specifically intend that their actions will result in infringement of at least Claims 1-23 of the '683 patent, or subjectively believes that their actions will result in infringement of the '683 patent but took deliberate actions to avoid learning of those facts, as set forth above. Nokia Corporation and Nokia Solutions and Networks Oy have persisted in encouraging the offer for sale, sale, making, and use of the LTE-compliant Infringing Products by their subsidiaries in a manner that infringes at least Claims 1-23 of the '683 patent (including by incorporating the Fast Dormancy feature described above), without a license from BlackBerry.

293. Nokia Corporation and Nokia Solutions and Networks Oy contributorily infringe at least Claims 1-23 of the '683 patent by providing, respectively, to subsidiaries Nokia Solutions and Networks Oy and Nokia Solutions and Networks US and to subsidiaries Nokia Solutions and Networks US the Infringing Products, and/or software or hardware components thereof, that perform or embody a material part of the claimed inventions of the '683 patent, that are known

by Nokia Corporation and Nokia Solutions and Networks Oy to be specially made or adapted for use in an infringing manner (including by using the Fast Dormancy feature described above), and are not staple articles, nor have substantial non-infringing uses. In particular, on information and belief, because the patented limitations cover features of the LTE Standards that have been widely-used in practice (including the Fast Dormancy feature described above), the portion of the hardware and/or software of the Infringing Products that performs or embodies the patented limitations of at least Claims 1-23 cannot feasibly be removed or disabled. Nokia Corporation and Nokia Solutions and Networks Oy have known their subsidiaries infringe at least Claims 1-23 by offering for sale, selling, making, and using the Infringing Products and/or software or hardware components thereof to practice these claims at latest as a result of BlackBerry filing and serving the original complaint in this action (ECF Nos. 1, 5, 6, 8).

294. Nokia's infringement has been, and continues to be, willful and deliberate, and has caused substantial damage to BlackBerry. In spite of Nokia's knowledge of the '683 patent, Nokia has continued making, using, offering for sale/lease, and/or selling or leasing in the United States, and/or importing into the United States, the Infringing Products that are compliant with the UMTS/UTRAN Standards (including the Fast Dormancy feature described above), without a license from BlackBerry. In spite of Nokia's knowledge of the '683 patent, Nokia has continued its conduct constituting induced infringement and contributory infringement of that patent. In committing acts of direct and indirect infringement, Nokia has committed egregious misconduct including, for example, acting despite knowing that its actions constituted infringement of the valid '683 patent, or recklessly disregarding the fact that its actions constituted an unjustifiably high risk of infringement of the valid and enforceable '683 patent. Nokia's willful and deliberate infringement warrants an award of enhanced damages.

**ELEVENTH CLAIM FOR RELIEF
(INFRINGEMENT OF UNITED STATES PATENT NO. 8,644,829)**

295. BlackBerry realleges and incorporates by reference the allegations of paragraphs 1-294 of this Amended Complaint.

The '829 Patent

296. The '829 patent is directed to, among other things, methods for “processing a signaling connection release indication message at a wireless network,” which includes “receiving from a user equipment a signaling connection release indication message including a signaling connection release indication cause indicating that no more data is expected at the user equipment,” where “the signaling connection release indication message is a request for a network-controlled state transition to an efficient battery Radio Resource Control (RRC) state or mode,” and “causing initiation of the network-controlled state transition for a signaling connection based on the signaling connection release indication cause.” (Exhibit J, '829 patent, Claim 17.) The '829 patent is also directed to a “wireless network apparatus for processing a signaling connection release indication message” that is configured to “receive from a user equipment a signaling connection release indication message including a signaling connection release indication cause indicating that no more data is expected at the user equipment,” where “the signaling connection release indication message is a request for a network-controlled state transition to an efficient battery Radio Resource Control (RRC) state or mode”; and to “initiate the network-controlled state transition for a signaling connection used on the signaling connection release indication cause.” (*Id.*, Claim 41.)

297. The '829 patent explains that, in a UMTS network, “[w]hen the UE is in an RRC connected mode, . . . it is the network that decides when to release the RRC connection.” (*Id.* at 2:5-6.) “Since the network may not know when the UE has completed data exchange for a given

application, it typically keeps the RRC connection for some time in anticipation of more data to/from the UE,” typically “to reduce the latency of call setup and subsequent radio bearer setup.” (*Id.* at 2:11-16.) Since “UTRAN is not aware of the status of data delivery between the UE and external server, the UE is forced to stay in a higher data rate and intensive battery state than the required state or mode, thereby draining battery life.” (*Id.* at 2:37-41.)

298. Prior to the invention disclosed in the '829 patent, one solution was “to have the UE send a signaling release indication to the UTRAN when the UE realizes that it is finished with data transaction,” but “the signaling release indication may be considered an alarm” that “results in inefficient performance monitoring and alarm monitoring at the network.” (*Id.* at 2:44-56.)

299. Among other things, the '829 patent discloses systems and methods for “transitioning [to a more battery-efficient state or mode] based on either the UE initiating termination of a signaling connection for a specified core network domain or indicating to the UTRAN that a transition should occur from one connected state to another.” (*Id.* at 3:29-38.)

300. The '829 patent discloses that a UE can append “to an existing signaling release indication, a field providing the cause for the signaling release indication,” which may be used “to filter true alarm conditions from situations in which a UE has requested to be put into an idle state because it is expecting no further data.” (*Id.* at 4:30-35.) This can improve “the efficiency of alarm and performance monitoring, while still allowing the UE to save battery resources by moving into an idle mode more quickly.” (*Id.* at 4:35-38.)

301. In one disclosed implementation, shown in Figure 10 (below), a network element that “receives the signaling connection release indication” can “examine[] the signaling release

indication cause field” and “check[] whether the cause is an abnormal cause or whether it is due to the UE requesting an idle transition.” (*Id.* at 14:20-25.)

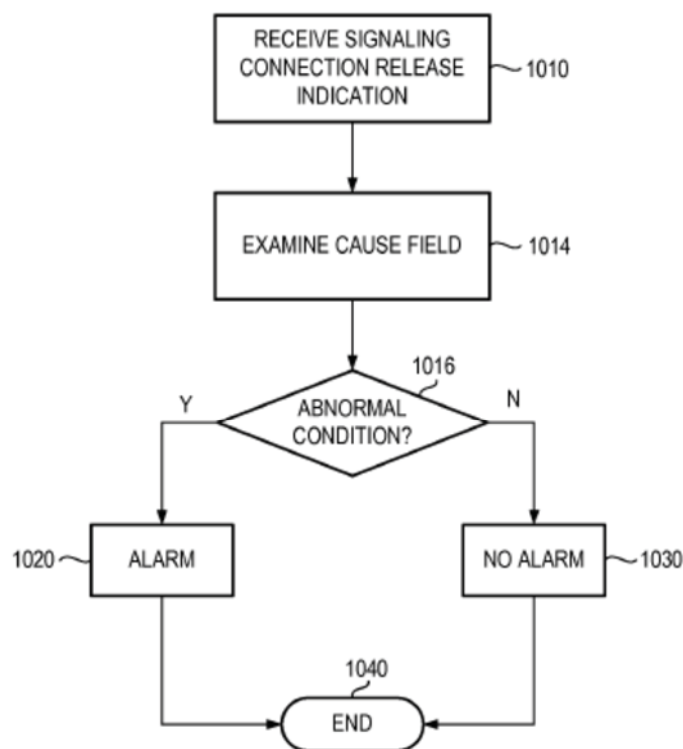

FIG. 10

If “the cause of the signaling connection release indication . . . is a result of the UE requesting an idle transition,” then “[t]he reception and examination of the signaling release indication cause field results in initiation by the network element of an RRC connection release procedure” that ends the data connection. (*Id.* at 14:30-42.)

302. The ‘829 patent further teaches that “[a] cause value is settable, in one implementation, as a ‘UE Requested PS Data session end’ rather than a ‘UE Requested idle transition’ to provide for the UTRAN to decide upon the state transition.” (*Id.* at 13:18-21.)

'829 patent Allegations

303. Nokia has infringed and is infringing, either literally or under the doctrine of equivalents, at least Claims 17-19, 21, 23-24, 41-42, 44-46, and 48-49 of the '829 patent in violation of 35 U.S.C. § 271 *et seq.*, directly and/or indirectly, by making, using, offering for sale/lease, and/or selling or leasing in the United States, and/or importing into the United States, without authority or license, the Infringing Products.

304. On information and belief, by complying with UMTS/UTRAN Standards, including the fast dormancy feature, the Infringing Products and their use are covered by at least Claims 17-19, 21, 23-24, 41-42, 44-46, and 48-49 of the '829 patent.

305. For example, Section 8.1.14 of the 3GPP TS 25.331 V8.24.0 specification describes a “Signalling connection release indication procedure.”

8.1.14 Signalling connection release indication procedure

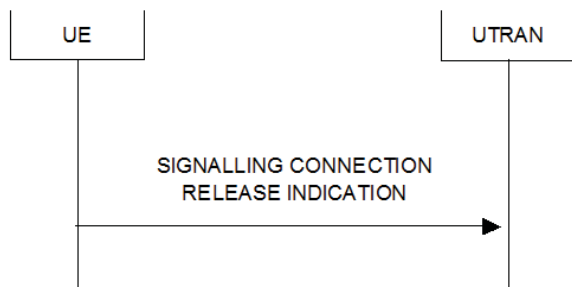

Figure 8.1.14-1: Signalling connection release indication procedure, normal case

8.1.14.1 General

The signalling connection release indication procedure is used by the UE to indicate to the UTRAN that one of its signalling connections has been released or it is used by the UE to request UTRAN to initiate a state transition to a battery efficient RRC state. The procedure may in turn initiate the RRC connection release procedure.

306. Section 8.1.14.2 of the 3GPP TS 25.331 V8.24.0 specification indicates that the UE may, “if the upper layers indicate there is no more PS data for a prolonged period, “set the IE ‘Signalling Connection Release Indication Cause’ to ‘UE Requested PS Data session end’” and “transmit a ‘SIGNALLING CONNECTION RELEASE INDICATION.’” Section 8.1.14.3 of

the 3GPP TS 25.331 V8.24.0 specification describes what occurs at the network side upon reception of the SIGNALLING CONNECTION RELEASE INDICATION.

8.1.14.3 Reception of SIGNALLING CONNECTION RELEASE INDICATION by the UTRAN

Upon reception of a SIGNALLING CONNECTION RELEASE INDICATION message, if the IE "Signalling Connection Release Indication Cause" is not included or the IE "Signalling Connection Release Indication Cause" is set to "any other cause", the UTRAN requests the release of the signalling connection from upper layers. Upper layers may then initiate the release of the signalling connection.

If the IE "Signalling Connection Release Indication Cause" is set to "UE Requested PS Data session end" in the SIGNALLING CONNECTION RELEASE INDICATION message the UTRAN may initiate a state transition to an efficient battery consumption RRC state such as IDLE, CELL_PCH, URA_PCH or CELL_FACH state.

307. Nokia has been, and currently is, an active inducer of infringement of the '829 patent under 35 U.S.C. § 271(b) and a contributory infringer of the '829 patent under 35 U.S.C. § 271(c).

308. On information and belief, the Infringing Products implement hardware and/or software configured to perform or embody the patented limitations of at least Claims 17-19, 21, 23-24, 41-42, 44-46, and 48-49 of the '829 patent. For example, the Infringing Products contain hardware and/or software designed to implement the fast dormancy feature in UMTS/UTRAN networks. On information and belief, the portion of the hardware and/or software that performs or embodies the patented limitations has no substantial non-infringing uses. In particular, because the patented limitations cover features of the UMTS/UTRAN Standards that have been widely-used in practice, viz., fast dormancy as described above, the portion of the hardware and/or software of the Infringing Products that performs or embodies the patented limitations cannot feasibly be removed or disabled.

309. Nokia knew of the '829 patent, or should have known of the '829 patent but was willfully blind to its existence. Nokia was put on notice of its infringement through a notice letter sent from BlackBerry prior to the filing of the original complaint in this action on February 14, 2017, and as a result of BlackBerry filing and serving the original complaint in this action

(ECF Nos. 1, 5, 6, 8). Nokia has had actual knowledge of the '829 patent since at least as early as Nokia cited the application that resulted in the issuance of the '829 patent on February 22, 2010, during Nokia's own patent prosecution as discussed above in paragraphs 88-89. Nokia developed, commercialized, demonstrated, and/or tested the Infringing Products despite its knowledge of the application that led to the issuance of the '829 patent from prosecution of Nokia's own patent application. Nokia has taken action intending to cause others to directly infringe the '829 patent, including by selling or offering for sale the Infringing Products to third parties in the United States while expressly promoting these products' capability to practice the fast dormancy feature of the UMTS/UTRAN Standards, knowing that using these products to practice the fast dormancy feature of the UMTS/UTRAN Standards would constitute direct infringement of the '829 patent. Therefore, on information and belief, Nokia knew or should have known of the '829 patent and of its own infringing acts, or deliberately took steps to avoid learning of those facts.

310. Nokia knowingly and intentionally encourages and aids at least its end-user customers to directly infringe the '829 patent. Nokia's end-user customers directly infringe at least Claims 17-19, 21, 23-24, 41-42, 44-46, and 48-49 of the '829 patent by using the Infringing Products in their intended manner (including the use of the Fast Dormancy feature described above) to infringe. Nokia induces such infringement by providing the Infringing Products, together with services, instructions, and technical support to enable and facilitate infringement (including the use of the Fast Dormancy feature described above), knowing of, or being willfully blind to the existence of, the '829 patent. On information and belief, Nokia specifically intends that its actions will result in infringement of at least Claims 17-19, 21, 23-24, 41-42, 44-46, and 48-49 of the '829 patent, or subjectively believes that its actions will result in infringement of the

'829 patent but took deliberate actions to avoid learning of those facts, as set forth above. Nokia has persisted in encouraging the use of the UMTS/UTRAN-compliant Infringing Products by its customers in a manner that infringes at least Claims 17-19, 21, 23-24, 41-42, 44-46, and 48-49 of the '829 patent (including by use of the Fast Dormancy feature described above), without a license from BlackBerry.

311. Nokia contributorily infringes at least Claims 17-19, 21, 23-24, 41-42, 44-46, and 48-49 of the '829 patent by providing to its customers the Infringing Products that perform or embody a material part of the claimed inventions of the '829 patent, that are known by Nokia to be specially made or adapted for use in an infringing manner, and are not staple articles with substantial non-infringing uses. The Infringing Products are specially designed to infringe at least Claims 17-19, 21, 23-24, 41-42, 44-46, and 48-49 of the '829 patent (including by use of the Fast Dormancy feature described above), and the Infringing Products have no substantial non-infringing uses. Nokia has known its customers infringe at least Claims 17-19, 21, 23-24, 41-42, 44-46, and 48-49 of the '829 patent by using the Infringing Products to practice these claims at latest as a result of BlackBerry filing and serving the original complaint in this action (ECF Nos. 1, 5, 6, 8).

312. Nokia Corporation knowingly and intentionally encourages and aids at least subsidiaries Nokia Solutions and Networks Oy and Nokia Solutions and Networks US to directly infringe the '829 patent. Nokia Solutions and Networks Oy knowingly and intentionally encourages and aids at least subsidiaries Nokia Solutions and Networks US to directly infringe the '829 patent. Nokia Solutions and Networks Oy and Nokia Solutions and Networks US directly infringe at least Claims 17-19, 21, 23-24, 41-42, 44-46, and 48-49 of the '829 patent at least by offering for sale, selling, making, and using the Infringing Products in the United States

(including those incorporating the Fast Dormancy feature described above). Nokia Corporation and Nokia Solutions and Networks Oy induce such direct infringement by encouraging, aiding, technically supporting, and instructing their subsidiaries to sell, offer for sale, make, and use the Infringing Products in the United States (including those incorporating the Fast Dormancy feature described above). Nokia Corporation and Nokia Solutions and Networks Oy further induce such direct infringement by encouraging, aiding, technically supporting, and instructing their subsidiaries to design and configure the Infringing Products so that they comply with the LTE standards (including the Fast Dormancy feature described above) in a manner that infringes at least Claims 17-19, 21, 23-24, 41-42, 44-46, and 48-49 of the '829 patent. On information and belief, Nokia Corporation and Nokia Solutions and Networks Oy specifically intend that their actions will result in infringement of at least Claims 17-19, 21, 23-24, 41-42, 44-46, and 48-49 of the '829 patent, or subjectively believes that their actions will result in infringement of the '829 patent but took deliberate actions to avoid learning of those facts, as set forth above. Nokia Corporation and Nokia Solutions and Networks Oy have persisted in encouraging the offer for sale, sale, making, and use of the LTE-compliant Infringing Products by their subsidiaries in a manner that infringes at least Claims 17-19, 21, 23-24, 41-42, 44-46, and 48-49 of the '829 patent (including by incorporating the Fast Dormancy feature described above), without a license from BlackBerry.

313. Nokia Corporation and Nokia Solutions and Networks Oy contributorily infringe at least Claims 17-19, 21, 23-24, 41-42, 44-46, and 48-49 of the '829 patent by providing, respectively, to subsidiaries Nokia Solutions and Networks Oy and Nokia Solutions and Networks US and to subsidiaries Nokia Solutions and Networks US the Infringing Products, and/or software or hardware components thereof, that perform or embody a material part of the

claimed inventions of the '829 patent, that are known by Nokia Corporation and Nokia Solutions and Networks Oy to be specially made or adapted for use in an infringing manner (including by using the Fast Dormancy feature described above), and are not staple articles, nor have substantial non-infringing uses. In particular, on information and belief, because the patented limitations cover features of the LTE Standards that have been widely-used in practice (including the Fast Dormancy feature described above), the portion of the hardware and/or software of the Infringing Products that performs or embodies the patented limitations of at least Claims 17-19, 21, 23-24, 41-42, 44-46, and 48-49 cannot feasibly be removed or disabled. Nokia Corporation and Nokia Solutions and Networks Oy have known their subsidiaries infringe at least Claims 17-19, 21, 23-24, 41-42, 44-46, and 48-49 by offering for sale, selling, making, and using the Infringing Products and/or software or hardware components thereof to practice these claims at latest as a result of BlackBerry filing and serving the original complaint in this action (ECF Nos. 1, 5, 6, 8).

314. Nokia's infringement has been, and continues to be, willful and deliberate, and has caused substantial damage to BlackBerry. In spite of Nokia's knowledge of the '829 patent, Nokia has continued making, using, offering for sale/lease, and/or selling or leasing in the United States, and/or importing into the United States, the Infringing Products that are compliant with the UMTS/UTRAN Standards (including the Fast Dormancy feature described above), without a license from BlackBerry. In spite of Nokia's knowledge of the '829 patent, Nokia has continued its conduct constituting induced infringement and contributory infringement of that patent. In committing acts of direct and indirect infringement, Nokia has committed egregious misconduct including, for example, acting despite knowing that its actions constituted infringement of the valid '829 patent, or recklessly disregarding the fact that its actions constituted an unjustifiably

high risk of infringement of the valid and enforceable '829 patent. Nokia's willful and deliberate infringement warrants an award of enhanced damages.

PRAYER FOR RELIEF

WHEREFORE, BlackBerry prays that the Court:

A. Render judgment declaring that Nokia has directly infringed, induced others to infringe, and/or contributed to the infringement of the '418, '246, '090, '305, '433, '697, '772, '192, '202, '683, and '829 patents;

B. Award BlackBerry damages adequate to compensate BlackBerry for Nokia's infringement of the '418, '246, '090, '305, '433, '697, '772, '192, '202, '683, and '829 patents;

C. Award an ongoing royalty for Nokia's ongoing infringement of the '418, '246, '090, '305, '433, '697, '772, '192, '202, '683, and '829 patents;

D. Render judgment declaring Nokia's infringement of the '418, '246, '090, '305, '433, '697, '772, '192, '202, '683, and '829 patents willful and deliberate, and award BlackBerry enhanced damages pursuant to 35 U.S.C. § 284;

E. Award BlackBerry pre-judgment and post-judgment interest to the full extent allowed under the law, as well as BlackBerry's costs and disbursements;

F. Enter an order finding that this is an exceptional case and awarding BlackBerry its reasonable attorneys' fees pursuant to 35 U.S.C. § 285; and

G. Award BlackBerry such other relief as the Court may deem appropriate and just.

DEMAND FOR A JURY TRIAL

Pursuant to Federal Rule of Civil Procedure 38(b), BlackBerry hereby demands a jury trial on all issues triable by a jury.

ASHBY & GEDDES

/s/ Andrew C. Mayo

Of Counsel:

Vincent J. Belusko
Hector G. Gallegos
MORRISON & FOERSTER LLP
707 Wilshire Boulevard, Suite 6000
Los Angeles, CA 90017-3543
(213) 892-5200

James P. Bennett
MORRISON & FOERSTER LLP
425 Market Street
San Francisco, CA 94105-2482
(415) 268-7000

Bradley S. Lui
Daniel P. Muino
MORRISON & FOERSTER LLP
2000 Pennsylvania Avenue, NW, Suite
6000
Washington, DC 20006-1888
(202) 887-1500

Jayson L. Cohen
MORRISON & FOERSTER LLP
250 West 55th Street
New York, NY 10019-9601
(212) 468-8000

Dated: June 26, 2017

John G. Day (#2403)
Andrew C. Mayo (#5207)
500 Delaware Avenue, 8th Floor
P.O. Box 1150
Wilmington, DE 19899
(302) 654-1888
jday@ashby-geddes.com
amayo@ashby-geddes.com

Attorneys for Plaintiff