

IN THE UNITED STATES DISTRICT COURT  
FOR THE EASTERN DISTRICT OF TEXAS  
MARSHALL DIVISION

SCA VENTURES, LLC	)	
	)	
Plaintiff,	)	
	)	Civil Action No. 2:17-cv-732
v.	)	
	)	<b>JURY TRIAL DEMANDED</b>
RICOH IMAGING AMERICAS	)	
CORPORATION	)	
	)	
Defendant.	)	
_____	)	

**COMPLAINT**

For its Complaint, Plaintiff SCA Ventures, LLC ("SCA"), by and through the undersigned counsel, alleges as follows:

**THE PARTIES**

1. SCA is a Texas company with a place of business located at 5068 W. Plano Parkway, Suite 300, Plano, Texas 75093.

2. Defendant Ricoh Imaging Americas Corporation is a Delaware company with, upon information and belief, a place of business located at Plano, Texas.

3. Upon information and belief, Defendant has registered with the Texas Secretary of State to conduct business in Texas.

4. By registering to conduct business in Texas and by having a place of business where it regularly conducts business in this District, Defendant has a permanent and continuous presence in Texas.

5. Thus, Defendant has a regular and established place of business in the Eastern District of Texas.

**JURISDICTION AND VENUE**

6. This action arises under the Patent Act, 35 U.S.C. § 1 *et seq.*

7. Subject matter jurisdiction is proper in this Court under 28 U.S.C. §§ 1331 and 1338.

8. Upon information and belief, Defendant conducts substantial business in this forum, directly or through intermediaries, including: (i) at least a portion of the infringements alleged herein; and (ii) regularly doing or soliciting business, engaging in other persistent courses of conduct and/or deriving substantial revenue from goods and services provided to individuals in this district.

9. Venue is proper in this district pursuant to § 1400(b).

**THE PATENT-IN-SUIT**

10. On October 19, 1999, United States Patent No. 5,969,698, entitled "Manually Controllable Cursor and Control Panel in a Virtual Image," was duly and lawfully issued by the U.S. Patent and Trademark Office. A true and correct copy of the '698 patent is attached hereto as Exhibit A.

11. SCA is the assignee and owner of the right, title and interest in and to the '698 patent, including the right to assert all causes of action arising under said patent and the right to any remedies for infringement of it.

**COUNT I – INFRINGEMENT OF U.S. PATENT NO. 5,969,698**

12. SCA repeats and realleges the allegations of paragraphs 1 through 11 as if fully set forth herein.

13. Without license or authorization and in violation of 35 U.S.C. § 271(a), Defendant has infringed at least claim 1 of the '698 patent by making, using, importing, offering for sale,

and/or selling portable electronic equipment including a virtual display, including, but not limited to Pentax K-5 Digital Camera ("K-5").

14. More specifically, K-5 is portable electronic equipment including a virtual display.

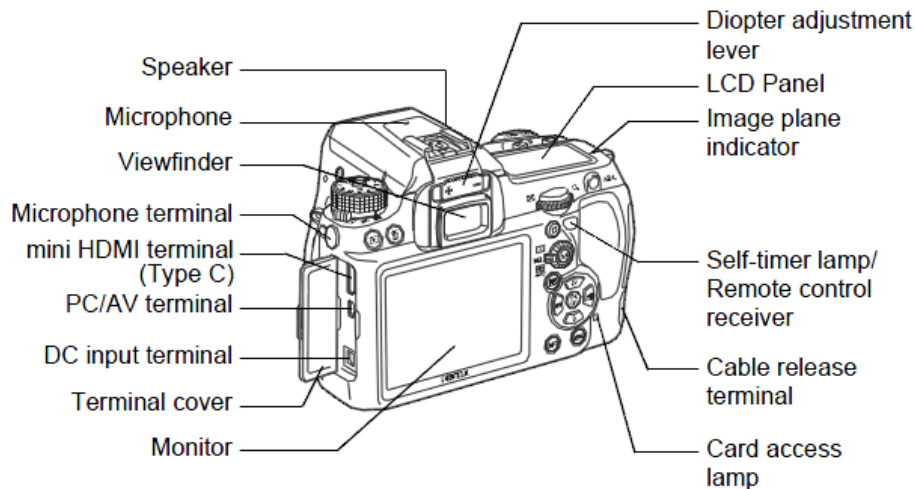

Pentax Digital Camera K-5 Operating Manual ("Manual") at p. 19 (available at <http://www.ricoh-imaging.co.jp/english/support/man-pdf/k-5.pdf> (last accessed Nov. 7, 2017)).

## **K-5 Characteristics**

- Features a 23.7×15.7 mm CMOS sensor with approximately 16.28 million effective pixels for high precision and a wide dynamic range.
- Features Shake Reduction (SR), an image sensor shifting shake reduction system. This enables you to capture sharp pictures with minimal camera shake regardless of the lens type.
- Features an AF sensor with 11 focusing points. The central 9 focusing points are wide cross area sensors.
- Features a viewfinder similar to that of a conventional 35 mm camera, with a magnification of approximately 0.92 and field of view of approximately 100%, for easier manual focusing. Also features a superimpose function in which the active AF point(s) on the viewfinder illuminate red.
- Features a large 3.0-inch monitor with approximately 921,000 dots, a wide viewing angle and brightness and color adjusting functions for high-precision viewing performance.

*Id.* at p. 16.

It includes electronics coupled to the virtual display for producing a manually controllable virtual cursor image when activated.

---

### Using the M (Hyper-manual) Mode

You can set the shutter speed and aperture value. This mode is suitable to take pictures of your choice by combining them. This mode is convenient for taking pictures using the same combination of the shutter speed and aperture settings or taking intentionally underexposed (darker) or overexposed (brighter) photographs.

☞ Effect of Aperture and Shutter Speed (p.93)

---

#### 1 Set the mode dial to M.

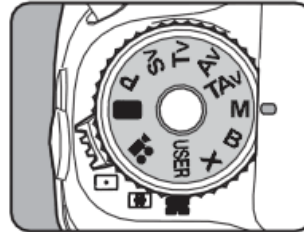

---

#### 2 Press the button.

The shutter speed and aperture value are automatically switched to obtain a proper exposure.

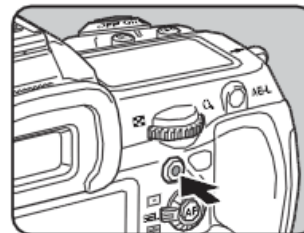

**3 Turn the front e-dial (☀️) to adjust the shutter speed.**

The shutter speed can be set within the range of 1/8000 to 30 seconds.

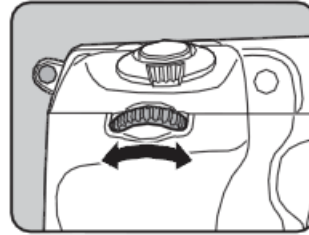

**4 Turn the rear e-dial (☀️) to adjust the aperture value.**

The set values are displayed in the status screen and viewfinder and on the LCD panel.

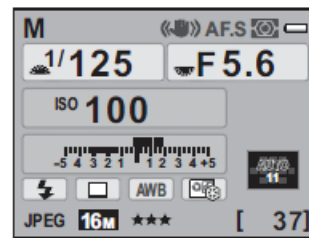
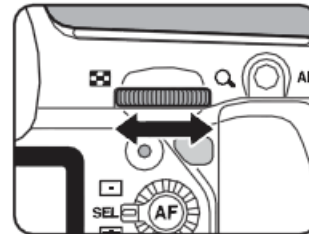

*Id.* at pp. 112-13. K-5 includes a virtual control panel image including alpha-numeric keys viewable in the virtual display when activated, and the electronics being connected so that the alpha-numeric keys of the virtual control panel image are operable with the virtual cursor image.

**4 Turn the rear e-dial (☀️) to adjust the aperture value.**

The set values are displayed in the status screen and viewfinder and on the LCD panel.

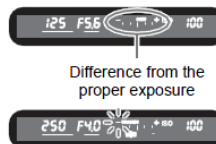
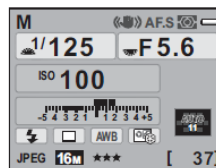
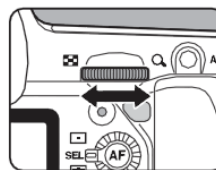

Difference from the proper exposure

While adjusting the shutter speed or aperture value, the difference from the proper exposure (EV value) is displayed in a bar graph. The proper exposure is set when **|** is in the middle of the EV bar. If it is towards -, it is underexposed. If it is towards +, it is overexposed. If the value exceeds the range of the EV bar ( $\pm 5.0$ ), or if the subject is too bright or too dark, the "+" or "-" blinks.

*Id.* at p. 113.

- The sensitivity cannot be set to [AUTO] in **M** mode. When the sensitivity is set to [AUTO] and the exposure mode is changed to **M** mode, the sensitivity is also changed to the lowest value set in “Setting the Range of Automatic Sensitivity Correction” (p.96).
- The shutter speed and aperture value can be set in increments of 1/3 EV or 1/2 EV. Set the exposure steps in [1. EV Steps] of the [**C** Custom Setting 1] menu. (p.120)
- Since the bar graphs in the viewfinder and on the LCD panel display the amount of camera tilt to the left or right, the difference from the proper exposure is displayed as a number when [Electronic Level] is set to  (On).

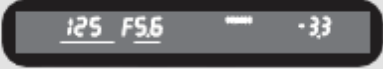

*Id.* at p. 114. As shown above, the electronics are further connected to operate the portable electronics equipment in response to operation of the alpha-numeric keys of the virtual control panel image with the virtual cursor image.

15. SCA is entitled to recover from Defendant the damages sustained by SCA as a result of Defendant's infringement of the '698 patent in an amount subject to proof at trial, which, by law, cannot be less than a reasonable royalty, together with interest and costs as fixed by this Court under 35 U.S.C. § 284.

### **JURY DEMAND**

SCA hereby demands a trial by jury on all issues so triable.

### **PRAYER FOR RELIEF**

WHEREFORE, SCA requests that this Court enter judgment against Defendant as follows:

A. An adjudication that Defendant has infringed the '698 patent;

B. An award of damages to be paid by Defendant adequate to compensate SCA for Defendant's past infringement of the '698 patent, including interest, costs, expenses and an accounting of all infringing acts including, but not limited to, those acts not presented at trial;

C. A declaration that this case is exceptional under 35 U.S.C. § 285, and an award of SCA's reasonable attorneys' fees; and

D. An award to SCA of such further relief at law or in equity as the Court deems just and proper.

Dated: November 8, 2017

*/s/ Richard C. Weinblatt*

---

Stamatios Stamoulis DE SB #4606  
Richard C. Weinblatt DE SB #5080 – Lead Counsel  
Stamoulis & Weinblatt LLC  
Two Fox Point Centre  
6 Denny Road, Suite 307  
Wilmington, DE 19809  
Telephone: (302) 999-1540  
Facsimile: (302) 762-1688  
stamoulis@swdelaw.com  
weinblatt@swdelaw.com

*Attorneys for Plaintiff  
SCA Ventures, LLC*