

**IN THE UNITED STATES DISTRICT COURT  
FOR THE NORTHERN DISTRICT OF ILLINOIS  
EASTERN DIVISION**

MOTOROLA SOLUTIONS INC.,

Plaintiff

v.

HYTERA COMMUNICATIONS  
CORPORATION LTD., AND  
HYTERA COMMUNICATIONS  
AMERICA (WEST), INC.

Defendants

CASE NO. 1:17-cv-1972

**AMENDED COMPLAINT FOR  
PATENT INFRINGEMENT**

**DEMAND FOR A JURY TRIAL**

**AMENDED COMPLAINT FOR PATENT INFRINGEMENT**

Plaintiff Motorola Solutions, Inc. (“Motorola”) alleges as follows against Defendants Hytera Communications Corporation Ltd. (“Hytera Corporation”) and Hytera Communications America (West), Inc. (“Hytera America West”) (collectively, “the Hytera Defendants”).

**INTRODUCTION**

1. This is a case about innovation, and the illegal misappropriation that threatens it. Since its founding almost 100 years ago in Chicago, Motorola has held its place as both the American and worldwide leader in providing innovative radio equipment and infrastructure technologies to thousands of public safety organizations, emergency response teams, transportation and logistics organizations, and numerous other customers involved in hospitality, manufacturing, education, utilities, oil and gas, and retail throughout the United States and around the world. Among its many innovations, Motorola has long been an industry leader in

cutting-edge digital two-way radio communication systems, and has invested its considerable expertise and creativity in developing such systems and bringing them to the public.

2. Such leadership requires extensive investments to maintain, in both financial and human terms. Motorola employs thousands of engineers in Illinois, other parts of the United States, and around the world, and spends hundreds of millions of dollars annually to research new technologies and develop a wide range of digital radio products and solutions for feature-rich, seamless communication in rapid-response networks across many industries and mission-critical applications. In order to protect its substantial investments in research and other forms of innovation, Motorola has sought and been awarded thousands of patents for its cutting-edge technologies.

3. The Hytera Defendants' story, by contrast, is quite different. Unlike Motorola, the Hytera Defendants have not invested the time, creative effort, or expense of the extensive research necessary to produce truly innovative technologies and products. Founded in 1993 in Shenzhen, China, Hytera Corporation was a distributor for Motorola products until 2001, and after that operated as a supplier of mostly analog radio products, as opposed to the sophisticated digital products that the industry was, and is, increasingly demanding. Critically, by the time Hytera Corporation began developing its digital two-way radio products, Motorola had already pioneered the field, and had established its digital two-way radio products as the leading communications solution for public safety organizations and its numerous commercial customers. Moreover, Motorola's investment in innovating digital radio was rendering Hytera Corporation's outdated analog systems obsolete. Complicating matters further for Hytera Corporation during this same time period, the United States Federal Communications

Commission set a deadline that effectively required suppliers of radio products to use digital technology.

4. Hytera Corporation knew that its analog radio products faced extinction, and that it could not hope to develop its own digital two-way radios in time to save its ailing business. Indeed, as Hytera Corporation's executive team acknowledged, its main product line—analogue radios—was quickly becoming “obsolete,” and its digital radios had to be developed at a “very quick pace.”<sup>1</sup> Thus, Hytera Corporation was faced with a choice: engage in time-consuming and resource-intensive development of its own digital product line, or simply take Motorola's technology, without permission, in order to get a product out to market “at a very quick pace.” Hytera Corporation chose the latter: rather than design its own digital two-way radio products to compete fairly in the marketplace, Hytera Corporation built its current digital two-way radio business by misappropriating Motorola's proprietary technologies and critical business strategies and copying Motorola's products—from key technologies in those products right down to the Motorola technical documentation describing them.

5. Hytera Corporation's investment was not in research and development, but in personnel—namely, Motorola's personnel who had substantial access to Motorola's proprietary technologies and who downloaded thousands of confidential technical documents in the weeks prior to their departures. Specifically, in order to break into the digital two-way radio market, beginning as early as 2008, Hytera Corporation, including through some of its most senior personnel, including its founder and Chairman Qingzhou Chen, lured away several Motorola senior radio engineers who were extensively familiar with Motorola's technologies and

---

<sup>1</sup> <https://www.youtube.com/watch?v=twxZXiWeNZQ>.

intellectual property.<sup>2</sup> Each of these engineers accepted employment at Hytera Corporation as part of Hytera Corporation's unlawful scheme to take Motorola's confidential information and copy Motorola's source code. These engineers were exposed to Motorola inventors' work on products and technology; they were privy to proprietary technical documents, Motorola's digital mobile radio (DMR) source code, and Motorola's design ideas; they were aware of Motorola's product planning and research and developments efforts; and they were intimately familiar with Motorola's patenting efforts, including those related to patents at issue in this case. Beyond that, unbeknownst to Motorola at the time and just weeks before they left Motorola, the engineers downloaded and misappropriated more than 7,000 technical, marketing, sales, and legal documents related to Motorola's digital radio and infrastructure products. In addition, the engineers surreptitiously copied Motorola's DMR source code, which they brought to Hytera Corporation and which Hytera Corporation has copied into at least Hytera Corporation's DMR subscriber and repeater products. Importantly, many of the materials the Hytera engineers took relate directly to patented technologies at issue in this case and provided a roadmap on how to incorporate and implement key features developed and patented by Motorola.

6. The engineers hired by Hytera Corporation—senior personnel within the organization (e.g., Gee Siong (G.S.) Kok was the Senior Vice President), acting on behalf of and with the direction of Hytera Corporation—intentionally hid their wrongful conduct from Motorola, to ensure it would not be discovered until years later. Motorola undertakes substantial precautions to ensure that its highly confidential information is not misused, including by restricting it to only its trusted employees having a need for such access. Motorola requires those employees not only to execute confidentiality agreements upon commencement of their

---

<sup>2</sup> See Exhibit 9, Case No. 17-cv-1973, D.I. 337, Nov. 9, 2018 Hr'g Tr. 24:12-16.

employment, but also to confirm their understanding of their obligations at the time of their departure, and affirmatively represent to Motorola upon their termination that they had not retained any Motorola confidential information.

7. Motorola also employs robust technical protections in its systems to detect and thwart unauthorized downloads and access to its confidential and sensitive information, and that technology has improved substantially in recent years over what was available in 2008. Due at least in part to their elevated positions with Motorola, the former Motorola engineers were able to evade Motorola's then-existing measures through a series of serious misrepresentations and carefully planned illegal acts, all of which took advantage of Motorola's trust in its senior product staff and the former employees' intimate knowledge of Motorola's systems. As a result of their illegal conduct and misrepresentations, these engineers ensured Motorola would not become aware of their conduct, and by extension, Hytera Corporation's infringement, until years after they left their employment at Motorola to go to work (unbeknownst to Motorola) at Hytera Corporation.

8. Hytera Corporation established Hytera America West in March 2016.<sup>3</sup> Since its inception, Hytera America West has been engaged in the importation of infringing DMR products from Hytera Corporation into the United States, as well as the marketing, sales, and service of those products in the western United States. Hytera America West has been aware of and improperly benefited from the former Motorola engineers' unauthorized downloading and copying of Motorola's documentation and source code, at least as a result of the litigation in *Motorola Solutions, Inc. v. Hytera Communications Corp.*, Case No. 1:17-cv-01973 (N.D. Ill.) and U.S. International Trade Commission Inv. No. 337-TA-1053, to which Hytera America West

---

<sup>3</sup> See Defs.' Mot. to Dismiss, Ex. A at ¶ 6.

is a party. In addition, Hytera America West's Vice President of Sales has repeatedly commented publicly about both litigations, confirming that Hytera America West is aware of its infringement and yet has not ceased its infringing activities.<sup>4</sup> Hytera America West has continued to import, use, market, sell, and offer for sale infringing products well after Motorola filed the original Complaint in this matter.<sup>5</sup>

9. In short, the Hytera Defendants and the former MSI engineers knew that the information they had downloaded was confidential, and knew as well that many of Motorola's digital two-way radio technologies were protected by patents. But despite this, the Hytera Defendants simply copied, used, and sold these critical technologies in their own competing products—products that bear the hallmarks of Motorola's innovation and product development. The Hytera Defendants' copying was deliberate, wholesale, and systematic—not only did they copy Motorola's patented technologies, they copied the marketing, configurations, and product manuals related to the infringing features as well. In fact, the Hytera Defendants' product manuals on these technologies are replete with images, graphs, and text that are nearly identical to the previously published product manuals of Motorola. And notwithstanding their unlawful conduct, the Hytera Defendants publicly tout the very innovations they took from Motorola as their own “innovations,” evidencing a degree of wanton misappropriation rarely seen in cases like these.<sup>6</sup>

---

<sup>4</sup> See, e.g., <https://www.businesswire.com/news/home/20180717006081/en/Global-DMR-Provider-Hytera-Appeals-Initial-Determination>; <https://www.rrmediagroup.com/Features/FeaturesDetails/FID/879>; <https://www.apnews.com/3ba2de45c6e34f679ec8133c47d99937>.

<sup>5</sup> Exhibit 10, Import Genius Records for the Hytera Defendants; Exhibit 11, PIERS importation records for the the Hytera Defendants.

<sup>6</sup> See Hytera DMR Introduction at 40, available at <http://www.w4ccl.com/Digital/TDMA/HyteraIntro.pdf>.

10. The Hytera Defendants' willful infringement and brazen copying left Motorola no choice but to file this lawsuit seeking injunctive relief and recovery of damages for the harm it has suffered. The Hytera Defendants did not even attempt to compete fairly with Motorola; rather than develop their own digital two-way radio products, through the scheme discussed above, they instead took a short-cut to the marketplace by copying and re-selling Motorola's patented and proprietary technologies. Such conduct makes investments in proprietary technologies such as those at issue in this action costly and pointless. And unless halted, the Hytera Defendants' illegal actions will serve as an encouragement to other companies simply to violate the intellectual property rights of true innovators without investing in research and development themselves. Simply put, the Hytera Defendants' conduct must be stopped.

#### **NATURE OF THE ACTION**

11. This is a civil action for patent infringement under the Patent Laws of the United States, 35 U.S.C. § 1 *et seq.* and for such other relief as the Court deems just and proper.

#### **THE PARTIES**

12. Plaintiff Motorola Solutions, Inc. (or "Motorola") is a company organized and existing under the laws of Delaware with its principal place of business at 500 W. Monroe Street, Chicago, IL 60661.

13. Defendant Hytera Communications Corporation Ltd. (or "Hytera Corporation") is a company organized and existing under the laws of the People's Republic of China, with its principal place of business at Hytera Tower, Hi-Tech Industrial Park North #9108 Beihuan Road, Nanshan District, Shenzhen, People's Republic of China.

14. Defendant Hytera Communications America (West), Inc. (or “Hytera America West”) is a company organized and existing under the laws of California with its principal place of business at 300 Spectrum Center Dr., Suite 1120, Irvine, California 92618.

### **JURISDICTION**

15. This civil action asserts claims arising under the Patent Laws of the United States, 35 U.S.C. § 1 *et seq.* This Court therefore has subject matter jurisdiction under 28 U.S.C. §§ 1331 and 1338(a).

16. This Court has personal jurisdiction over Hytera Corporation. Personal jurisdiction exists over Hytera Corporation because it (directly and/or through its subsidiaries, divisions, groups or distributors) has sufficient minimum contacts with the Northern District of Illinois as a result of substantial business conducted within the State of Illinois, including through importation of infringing products in this District for use and sale in this District, as alleged further immediately below.

17. Hytera Corporation has committed acts of infringement in this District and the State of Illinois, including at least because it (directly and/or through its subsidiaries, divisions, groups, or distributors) advertises, markets, offers for sale, imports for sale and/or sells the infringing products at issue in this case in this District and the State of Illinois, and places those infringing products in the stream of commerce with the expectation and knowledge that they will be purchased by consumers in this District.<sup>7</sup> As such, Hytera Corporation has committed tortious acts in this District and the State of Illinois; has expressly aimed its actions at this District and the State of Illinois with the knowledge that they would cause harm and substantial injury to Motorola in the District and the State of Illinois; and Motorola’s claims relate to Hytera

---

<sup>7</sup> See Defs.’ Mot. to Dismiss, Ex. A at ¶ 3 (“[Hytera America, Inc.] imports products manufactured by Hytera Corporation for sale in the United States.”), ¶ 6 (“Hytera America West imports products manufactured by Hytera Corporation for sale in the United States.”)



Corporation's products containing technology misappropriated from Motorola and advertised, marketed, used, offered for sale, imported, and/or sold in this District and in the State of Illinois.

18. U.S. customs importation records confirm that Hytera Corporation has committed acts of infringement by importing products, including the accused products, into the United States.<sup>8</sup> In addition, Hytera Corporation has previously been found to import products into the United States. In Inv. No. 337-TA-1053, Administrative Law Judge ("ALJ") McNamara of the U.S. International Trade Commission ("USITC") specifically found that Hytera Corporation violated subsection (b) of Section 337 of the Tariff Act of 1930 in the importation into the United States, the sale for importation, or the sale within the United States after importation" of the accused two-way radio products at issue here:<sup>9</sup>

It is a finding of this ID that Complainant Motorola Solutions, Inc. ("Complainant" or "Motorola") has proven by a preponderance of evidence that Respondents Hytera Communications Corp. Ltd., Hytera America, Inc., and Hytera Communications America (West), Inc. (collectively, "Respondents" or "Hytera") have violated subsection (b) of Section 337 of the Tariff Act of 1930, in the importation into the United States, the sale for importation, or the sale within the United States after importation of certain two-way radio equipment and systems, related software and components thereof.

The USITC accordingly issued a Limited Exclusion Order directed at Hytera Corporation prohibiting the "unlawful importation, sale for importation, or sale within the United States after importation" of devices it found to infringe.<sup>10</sup> On November 16, 2018, the Chairman of the USITC sent a copy of the limited exclusion order to the President of the United States, the

---

<sup>8</sup> Exhibit 10, Import Genius Records for the Hytera Defendants (showing Hytera Corporation has shipped products directly to its subsidiaries, distributors, and customers within the United States); Exhibit 11, PIERS importation records for the the Hytera Defendants (same).

<sup>9</sup> Exhibit 12, *Certain Two-Way Radio Equipment and Systems, Related Software and Components Thereof*, Initial Determination on Violation of Section 337 and Recommended Determination on Remedy and Bond (Public Version), Inv. No. 337-TA-1053 at ii, *affirmed in relevant part* by Exhibit 13, Commission Opinion (Public Version), Inv. No. 337-TA-1053 at 8-9.

<sup>10</sup> Exhibit 14, *Certain Two-Way Radio Equipment and Systems, Related Software and Components Thereof*, Limited Exclusion Order at 1.

Secretary of the Treasury, and the United States Trade Representative, explaining that the “limited exclusion order prohibits . . . Hytera Communications Corp. Ltd. of Shenzhen, China [Hytera Corporation] . . . from importing into the United States” products covered by certain Motorola patents.<sup>11</sup> The U.S. President did not disapprove of the USITC’s determination under 19 U.S.C. § 1337(j)(4), and the Limited Exclusion Order accordingly went into effect on January 15, 2019.

19. In addition, Hytera Corporation distributes its infringing products through a number of District- and Illinois-based distributors, including Alpha Prime Communications, Voceon Digital Radio Communications, Lakeland Communication Service, Ragan Communications, A Beep, and Concept Wireless Communications, Inc. Hytera Corporation has also distributed infringing products to customers in this District and the State of Illinois, including the University of Illinois.<sup>12</sup> Hytera Corporation also claims that its “Global Presence” is based, in part, in Chicago, Illinois.<sup>13</sup> Hytera Corporation has further availed itself of contacts and business in this District and the State of Illinois by actively advertising and promoting the products that contain the misappropriated technology. For example, on November 2, 2016, Mr. G.S. Kok, Hytera Corporation’s Senior Vice President delivered the keynote of Hytera Corporation’s future plans in the digital radio market (which include Hytera Corporation’s use of Motorola’s trade secrets) at a conference held in Chicago, Illinois.<sup>14</sup> Seven executives of Hytera Corporation attended this conference in Chicago, in order to, among other things, increase sales in this District and the State of Illinois of products that contain Motorola’s misappropriated

---

<sup>11</sup> Exhibit 15, Nov. 16, 2018 Letter from ITC Chairman to President, Secretary of the Treasury, and United States Trade Representative.

<sup>12</sup> See [http://wiki.radioreference.com/index.php/University\\_of\\_Illinois\\_at\\_Urbana-Champaign](http://wiki.radioreference.com/index.php/University_of_Illinois_at_Urbana-Champaign).

<sup>13</sup> See [https://tandcca.com/fm\\_file/tetrainchile2015hytera-pdf/](https://tandcca.com/fm_file/tetrainchile2015hytera-pdf/) at slide 11 (titled “Hytera Global Presence”, and specifically naming and pointing at Chicago as a location that is part of its “Global Presence”).

<sup>14</sup> See <https://www.hytera.us/news/hytera-communications-presented-the-keynote;>  
<http://www.criticaltcommunications.net/program-day-one/>.

technology.<sup>15</sup> As such, Hytera Corporation has demonstrated that it is ready and willing to conduct business with residents of this District and the State of Illinois, and actively do so.

20. Hytera Corporation has also induced and contributed to acts of infringement in this District. As ALJ McNamara found, Hytera Corporation had specific intent to infringe the asserted patents.<sup>16</sup> Hytera Corporation hired three Motorola engineers who were directly familiar with Motorola's innovations and technologies, and in particular were conversant with the functionalities and innovations represented by the specific patents at issue in this case.<sup>17</sup> For example, Hytera Corporation's former Senior Vice President responsible for digital technologies, G.S. Kok, worked at Motorola for five years as a senior engineer manager; Hytera Corporation's former Software Engineering Director, Samuel Chia, worked at Motorola for almost ten years as an engineering manager; and Hytera Corporation's former Sales Director, Yih Tzye (Y.T.) Kok, worked at Motorola as a software architect for almost ten years. These engineers were well-versed in Motorola's proprietary technologies and patenting efforts, had direct responsibility for the design and development of Motorola's digital product lines, and had direct access to associated confidential source code and technical documentation concerning implementation of Motorola's patented and proprietary technologies. In their final days at Motorola, and without informing the company where they were going, these engineers downloaded at least 7,000 of Motorola's technical documents, including foundational documents regarding Motorola's digital technologies and disclosures related to Patents-in-Suit. They took not only their own specific

---

<sup>15</sup> See <http://urgentcomm.com/hytera/hytera-andy-zhao-outlines-companys-technology-roadmap-lte-other-next-generation-products>.

<sup>16</sup> Exhibit 12, *Certain Two-Way Radio Equipment and Systems, Related Software and Components Thereof*, Initial Determination on Violation of Section 337 and Recommended Determination on Remedy and Bond (Public Version), Inv. No. 337-TA-1053 at 204-226.

<sup>17</sup> *Id.* at 204-206.

knowledge and expertise that they had developed while at Motorola, but also that of Motorola more generally.

21. When asked about whether certain aspects of the accused products were developed using Motorola's confidential information, each of these three former Motorola employees invoked the Fifth Amendment to avoid answering.<sup>18</sup> Y.T. Kok invoked his Fifth Amendment right to more than 70 questions, Samuel Chia also invoked his Fifth Amendment right to more than 70 questions, and G.S. Kok invoked his Fifth Amendment right against self-incrimination to more than 60 questions.<sup>19</sup> For example, when Y.T. Kok, G.S. Kok, and Samuel Chia were asked about whether the specific features accused of infringing the asserted patents here—such as “scan,” “pseudo trunking,” and the “subscriber inactivity timer” were developed using Motorola confidential information, they refused to answer.<sup>20</sup> ALJ McNamara found that Hytera Corporation's employees' invocation of the Fifth Amendment to avoid answering questions gives rise to an inference that they did indeed copy some or all of the documents they accessed from Motorola's document management system.<sup>21</sup> ALJ McNamara further drew an adverse inference that “Hytera intentionally copied Motorola's patented technologies into the Accused Products.”<sup>22</sup> The ALJ also determined that “certain accused features of Hytera's Accused Products were developed from and/or encompass aspects of Motorola's technologies described in the '284, '869, and '701 patents.”<sup>23</sup> For example, Hytera Corporation explicitly relied on a Motorola document in the software requirements specification for its Extended

---

<sup>18</sup> *Id.* at 206, 215.

<sup>19</sup> *Id.* at 215.

<sup>20</sup> *Id.* at 216-17.

<sup>21</sup> *Id.* at 219.

<sup>22</sup> *Id.* at 219-20.

<sup>23</sup> *Id.* at 220.

Pseudo Trunking functionality.<sup>24</sup> Hytera Corporation further copied material from a presentation about the '869 patent that one of the inventors of certain of the asserted patents, Mr. Thomas Bohn, made into one or more of Hytera's technical presentations.<sup>25</sup> The former Motorola employees, Samuel Chia and Y.T. Kok, also received information from one of the inventors of the '701 patent summarizing the invention before they left Motorola for Hytera.<sup>26</sup> The USITC affirmed ALJ McNamara's determination that Hytera had the specific intent to infringe the asserted patents.<sup>27</sup>

22. Hytera Corporation has also been willfully blind to Motorola's patent portfolio.<sup>28</sup> G.S. Kok, Samuel Chia, and Y.T. Kok downloaded documents in 2008 that involved several features related to the asserted patents.<sup>29</sup> Hytera Corporation's employees, including Samuel Chia "monitored the filing and issuance of Motorola patents related to Motorola's new two-way radio technology, and were aware of Motorola's patents and its patent portfolio."<sup>30</sup> Other employees of Hytera Corporation documented that Hytera Corporation searched and analyzed Motorola's patents.<sup>31</sup> Hytera Corporations did not take any steps to avoid infringing Motorola's patents.<sup>32</sup>

23. This Court has personal jurisdiction over Hytera America West. Personal jurisdiction exists over Hytera America West because it (directly and/or through its subsidiaries, divisions, groups or distributors) has sufficient minimum contacts with the Northern District of

---

<sup>24</sup> *Id.* at 221.

<sup>25</sup> *Id.*

<sup>26</sup> *Id.*

<sup>27</sup> Exhibit 13, Commission Opinion (Public Version), Inv. No. 337-TA-1053 at 22.

<sup>28</sup> Exhibit 12, *Certain Two-Way Radio Equipment and Systems, Related Software and Components Thereof*, Initial Determination on Violation of Section 337 and Recommended Determination on Remedy and Bond (Public Version), Inv. No. 337-TA-1053 at 223-226.

<sup>29</sup> *Id.* at 225.

<sup>30</sup> *Id.*

<sup>31</sup> *Id.*

<sup>32</sup> *Id.* at 226.

Illinois as a result of substantial business conducted within the State of Illinois, including through sales and importation of infringing products in this District, as alleged further immediately below. For example, Hytera America West's use, offer for sale, and/or sale of infringing products at its Schaumburg, Illinois constitute continuing acts of infringement. One of the other companies with whom Hytera America West shares its office space at 1916 Wright Boulevard, Schaumburg, Illinois 60193, is Voceon Chicago, a Hytera "authorized family dealer" that advertises its "expert service and repair," "new equipment sales and installation," and sale of "accessories and replacement parts."<sup>33</sup>

24. Hytera America West has committed acts of infringement in this District and the State of Illinois, including at least because it (directly and/or through its subsidiaries, divisions, groups, or distributors) advertise, market, offer for sale, import for sale and/or sell the infringing products at issue in this case in this District and the State of Illinois, and place those infringing products in the stream of commerce with the expectation and knowledge that they will be purchased by consumers in this District.<sup>34</sup> As such, Hytera America West has committed tortious acts in this District and the State of Illinois; has expressly aimed its actions at this District and the State of Illinois with the knowledge that they would cause harm and substantial injury to Motorola in the District and the State of Illinois; and Motorola's claims relate to Hytera America West's products containing technology misappropriated from Motorola and advertised, marketed, used, offered for sale, imported, and/or sold in this District and in the State of Illinois.

25. Hytera America West has also distributed infringing products to customers in this District and the State of Illinois. Hytera America West also employs individuals in this District and the State of Illinois. For example, Hytera America West claims to have employed a sales

---

<sup>33</sup> See <http://www.voceon.com/AboutUs.php>

<sup>34</sup> See Defs.' Mot. to Dismiss, Ex. A at ¶ 6 ("Hytera America West imports products manufactured by Hytera Corporation for sale in the United States.")

representative named Chad Stojkovich beginning in January of 2017 and claims to currently employ at least three other employees in the district at its warehouse facility in Schaumburg, Illinois.<sup>35</sup> Hytera America West further advertises that it has “operations” in Chicago, Illinois.<sup>36</sup> As such, Hytera Corporation has demonstrated that it is ready and willing to conduct business with residents of this District and the State of Illinois, and actively do so.

26. Also, similar to Hytera Corporation, Hytera America West has previously been found to import products into the United States in violation of subsection (b) of Section 337 of the Tariff Act of 1930.<sup>37</sup> The USITC accordingly issued a Limited Exclusion Order directed at Hytera America West prohibiting the “unlawful importation, sale for importation, or sale within the United States after importation” of devices it found to infringe.<sup>38</sup> On November 16, 2018, the Chairman of the USITC sent a copy of the limited exclusion order to the President of the United States, the Secretary of the Treasury, and the United States Trade Representative, explaining that the “limited exclusion order prohibits . . . Hytera Communications America (West), Inc. of Irvine, California [Hytera America West] . . . from importing into the United States” products covered by certain Motorola patents.<sup>39</sup> The U.S. President did not disapprove of the USITC’s determination under 19 U.S.C. § 1337(j)(4), and the Limited Exclusion Order accordingly went into effect on January 15, 2019.

---

<sup>35</sup> See Defs.’ Mot. to Dismiss, Ex. A at ¶ 9; see e.g., David Brewer, LinkedIn, <https://www.linkedin.com/in/david-brewer-hwengineer/> (last visited Mar. 8, 2019).

<sup>36</sup> See <https://www.hytera.us/news/hytera-to-sponsor-international-security-conference-exposition-the-us-largest-event-for-the-physical-security-industry>

<sup>37</sup> Exhibit 12, *Certain Two-Way Radio Equipment and Systems, Related Software and Components Thereof*, Initial Determination on Violation of Section 337 and Recommended Determination on Remedy and Bond (Public Version), Inv. No. 337-TA-1053 at ii, *affirmed in relevant part* by Exhibit 13, Commission Opinion (Public Version), Inv. No. 337-TA-1053 at 8-9.

<sup>38</sup> Exhibit 14, *Certain Two-Way Radio Equipment and Systems, Related Software and Components Thereof*, Limited Exclusion Order at 1.

<sup>39</sup> Exhibit 15, Nov. 16, 2018 Letter from ITC Chairman to President, Secretary of the Treasury, and United States Trade Representative.

**VENUE**

27. Venue properly lies in this District under 28 U.S.C. §§ 1391 and 1400(b).

28. Venue is proper in this District as to Hytera Corporation because it is foreign corporation that is subject to personal jurisdiction in this District as noted above in Paragraphs 16 through 22 of this Amended Complaint, which Motorola incorporates and re-alleges as if fully set forth herein.

29. Venue is proper as to Hytera America West because it has committed acts of infringement in this District as noted above in Paragraphs 23 through 26 of this Amended Complaint, which Motorola incorporates and re-alleges as if fully set forth herein. Hytera America West continues to infringe by making, using, selling, and/or offering for sale infringing products in the District. Hytera America West further maintains a regular and established place of business at 1916 Wright Boulevard, Schaumburg, Illinois 60193. Andrew Yuan, the Vice President of Hytera Corporation and former President of Hytera America West, admitted that “Hytera America West rents space at an office park in Schaumburg that it shares with other companies.”<sup>40</sup> Although Mr. Yuan has declared under oath that “[t]he Schaumburg office wasn’t opened until after the Complaint was filed in this case,”<sup>41</sup> public records in fact indicate that Hytera America West began leasing its Schaumburg, Illinois warehouse and repair facility in 2016, and continues to lease that facility today.<sup>42</sup>

30. In addition, venue is proper because Motorola is headquartered in this District; has made significant investments of both equipment and engineering talent in this District; invented in this District certain of the Patents-in-Suit; and has suffered harm in this District.

---

<sup>40</sup> See Defs.’ Mot. to Dismiss, Ex. A at ¶ 8.

<sup>41</sup> *Id.*

<sup>42</sup> See Exhibit 16, Compstak Commercial Property Information 1900-1924 Wright Blvd. Schaumburg, Illinois; see Defs.’ Mot. to Dismiss, Ex. A at ¶ 8.



**GENERAL ALLEGATIONS**

**MOTOROLA LEADS THE WORLD IN DIGITAL  
TWO-WAY RADIO TECHNOLOGIES**

31. In the United States and around the world, Motorola leads the industry in two-way digital radio products, technologies, and supporting infrastructure and systems. Ever since the company's founding in 1928, Motorola's engineers and technicians have focused on developing the hardware, software, and systems necessary to create innovative and durable products that enable rapid and seamless communications in a variety of different organizations and environments, from construction sites to emergency dispatch systems to school bus networks.

32. Such commitment to cutting-edge innovation in the service of customers—whether they are private enterprises, public safety organizations like police and fire departments, or emergency medical providers—does not come cheaply. Motorola has always invested heavily in research and development, spending more than \$3.5 billion in the last five years alone, along with the time, dedication and creativity of thousands of Motorola engineers, technicians, and other staff. These efforts are reflected in Motorola's rich store of intellectual property, including thousands of patents, including those at issue in this case that have been blatantly infringed by Hytera.

33. Motorola's unwavering focus on research and development has ensured that its innovative features have driven the proliferation of Motorola's products and secured Motorola's position as a global leader in digital telecommunications products and services. Today, Motorola offers a variety of pioneering radio products and systems recognized by customers as providing mission-critical and feature-rich communication for workers, including MotoTRBO DMR radios and infrastructure for commercial customers, Dimetra TETRA radios and infrastructure for mission critical communications, and ASTRO and APX Project 25 ("P25") radios, infrastructure,

and dispatch systems for emergency responders and public safety organizations. Features that are central to the successful deployment of these systems include those covered by the Patents-in-Suit, such as trunking for decentralized systems, IP Site-Connect, fast scanning, efficient repeater access, adaptive volume control, and dispatch connectivity—all proprietary technologies developed by Motorola through ingenuity, investment, and perseverance.

34. In short, across numerous communication environments—whether a state police force or private courier service—Motorola’s patented and proprietary technologies uniquely improve how people and businesses connect and communicate with one another wirelessly including across great distances in an effective, reliable, and innovative manner. Motorola’s intellectual property rights, including its patent rights, protect these valuable technologies developed by Motorola. As a result of its innovations, Motorola has developed a substantial portfolio of patents, including the seven patents infringed by the Hytera Defendants at issue in this case.

#### **MOTOROLA’S PATENTED TECHNOLOGIES**

35. Motorola’s products incorporate numerous patented technologies developed and owned by Motorola. Seven examples of Motorola’s patented technologies that are included in Motorola’s products are described below (collectively, “the Patents-in-Suit”).<sup>43</sup> These patented technologies represent important developments and innovations in radio communications and are critically important to Motorola’s customers and clients, and the success of Motorola’s leading products. Motorola relies on the use and deployment of these proprietary technologies to compete in the marketplace.

---

<sup>43</sup> See Exhibit 1.

**U.S. Patent No. 8,116,284**

36. U.S. Patent No. 8,116,284 (“the ’284 Patent”), entitled “Method, Device and System for Temporarily Selecting a Timeslot,” was issued on February 14, 2012 to inventors Kin Wei Wong, Hooi Hoon Ch’ng, Lip Hong Lim, and Chun Yee Tan. A true and correct copy of the ’284 Patent is attached as Exhibit 2.

37. Motorola is the owner and sole assignee of the ’284 Patent and has the full right to enforce and/or license the ’284 Patent.

38. The ’284 Patent is valid and enforceable.

**U.S. Patent No. 8,032,169**

39. U.S. Patent No. 8,032,169 (“the ’169 Patent”), entitled “System and Method for Providing Low Overhead Floor Control in a Distributed Peer-to-Peer Communications Network,” was issued on October 4, 2011 to inventors Alain D. Abbate and Subhash P. Nair. A true and correct copy of the ’169 Patent is attached as Exhibit 3.

40. Motorola is the owner and sole assignee of the ’169 Patent and has the full right to enforce and/or license the ’169 Patent.

41. The ’169 Patent is valid and enforceable.

**U.S. Patent No. 7,369,869**

42. U.S. Patent No. 7,369,869 (“the ’869 Patent”), entitled “Method and System of Scanning a TDMA Channel,” was issued on May 6, 2008 to inventors David G. Wiatrowski, Thomas B. Bohn, Satyanarayan R. Panpaliya, and Thomas J. Senese. A true and correct copy of the ’869 Patent is attached as Exhibit 4.

43. Motorola is the owner and sole assignee of the ’869 Patent and has the full right to enforce and/or license the ’869 Patent.

44. The '869 Patent is valid and enforceable.

**U.S. Patent No. 7,729,701**

45. U.S. Patent No. 7,729,701 (“the '701 Patent”), entitled “Method and System of Accessing a De-Keyed Base Station,” was issued on June 1, 2010 to inventors David G. Wiatrowski, Thomas B. Bohn, and Thomas J. Senese. A true and correct copy of the '701 Patent is attached as Exhibit 5.

46. Motorola is the owner and sole assignee of the '701 Patent and has the full right to enforce and/or license the '701 Patent.

47. The '701 Patent is valid and enforceable.

**U.S. Patent No. 8,279,991**

48. U.S. Patent No. 8,279,991 (“the '991 Patent”), entitled “Method of Efficiently Synchronizing to a Desired Timeslot in a Time Division Multiple Access Communication System,” was issued on October 2, 2012 to inventors David Wiatrowski, Dipendra M. Chowdhary, and Thomas B. Bohn. A true and correct copy of the '991 Patent is attached as Exhibit 6.

49. Motorola is the owner and sole assignee of the '991 Patent and has the full right to enforce and/or license the '991 Patent.

50. The '991 Patent is valid and enforceable.

**U.S. Patent No. 9,099,972**

51. U.S. Patent No. 9,099,972 (“the '972 Patent”), entitled “Method and Apparatus for Multi-stage Adaptive Volume Control,” was issued on August 4, 2015 to inventors Yi Gao, James D. Barrus, William M. Kushner, Yu Liu, and Li Xiao. A true and correct copy of the '972 Patent is attached as Exhibit 7.

52. Motorola is the owner and sole assignee of the '972 Patent and has the full right to enforce and/or license the '972 Patent.

53. The '972 Patent is valid and enforceable.

**U.S. Patent No. 6,591,111**

54. U.S. Patent No. 6,591,111 (“the '111 Patent”), entitled “Group Radio Communication System and Method Using Interconnected Radio Sub-Networks,” was issued on July 8, 2003 to inventors Jonathan David Stosz, Rhett Garrett Hayden, Dean Paul Vanden Heuvel, Charles Joseph Ganucheau, Jr., and Scott David Blanchard. A true and correct copy of the '111 Patent is attached as Exhibit 8.

55. Motorola is the owner and sole assignee of the '111 Patent and has the full right to enforce and/or license the '111 Patent.

56. The '111 Patent is valid and enforceable.

**THE HYTERA DEFENDANTS ARE  
WILLFULLY INFRINGING MOTOROLA'S PATENTS**

57. Motorola has developed its reputation for the best and most feature-rich digital radio systems through almost a century of hard work, financial commitment, and engineering innovation. The Hytera Defendants have not.

58. Founded in China in 1993, Hytera Corporation had direct access to Motorola's products when it operated as a distributor for seven years, until 2001. Hytera Corporation also began supplying its own analog radio products and was hoping to begin making and selling digital radio communications products under its own name, but lacked the necessary manufacturing, product development, and technological know-how to do so. Having failed to incur the expense and time to develop its own products in the past, Hytera Corporation made a conscious decision not to innovate. Instead, Hytera Corporation took a shortcut to entering the

market for competing digital radio products, by pilfering Motorola-developed technology and intellectual property.

59. Significantly, Hytera Corporation hired three Motorola engineers who were directly familiar with Motorola's innovations and technologies, and in particular were conversant with the functionalities and innovations represented by the specific patents at issue in this case.<sup>44</sup> For example, Hytera Corporation's former Senior Vice President responsible for digital technologies, G.S. Kok, worked at Motorola for five years as a senior engineer manager; Hytera Corporation's former Software Engineering Director, Samuel Chia, worked at Motorola for almost ten years as an engineering manager; and Hytera Corporation's former Sales Director, Y.T. Kok, worked at Motorola as a software architect for almost ten years. These engineers were well-versed in Motorola's proprietary technologies and patenting efforts, had direct responsibility for the design and development of Motorola's digital product lines, and had direct access to associated confidential source code and technical documentation concerning implementation of Motorola's patented and proprietary technologies. In their final days at Motorola, and without informing the company where they were going, these engineers downloaded at least 7,000 of Motorola's technical documents, including foundational documents regarding Motorola's digital technologies and disclosures related to Patents-in-Suit. They took not only their own specific knowledge and expertise that they had developed while at Motorola, but also that of Motorola more generally. These engineers made careful choices about the technologies they misappropriated.

60. Hytera America West has had knowledge of the Patent-in-Suits at least as the result of the filing of the original Complaint in this action, U.S. International Trade Commission

---

<sup>44</sup> *Id.* at 204-26.

Inv. No. 337-TA-1053, and the litigation in *Motorola Solutions, Inc. v. Hytera Communications Corp.*, Case No. 1:17-cv-01973 (N.D. Ill.). Nonetheless, Hytera America West has willfully and intentionally used, sold, offered to sell, and imported products, and continue to use, sell, offer to sell, and import products with Motorola's patented technologies. Further, Hytera America West has been aware of and improperly benefited from the former Motorola engineers' unauthorized downloading and copying of Motorola's documentation and source code. In addition, Hytera America West's Vice President of Sales, Tom Wineland, has repeatedly commented publicly about the -01973 litigation and Inv. No. 337-TA-1053, confirming that Hytera America West is aware of its infringement and yet has not ceased its infringing activities.<sup>45</sup>

61. The Hytera Defendants were intentional in maximizing the value to themselves of that intellectual property. The Motorola technological developments improperly used by the Hytera Defendants are among the most valuable of Motorola's innovations, driving customer demand for many of the Hytera Defendants' products. For example, as part of their sales and marketing efforts, the Hytera Defendants tout the presence of each one of the accused technologies, such as "Pseudo-trunking," "IP Multi-Site-Connect," efficient repeater access, fast scanning, adaptive volume control, and dispatch connectivity, all of which were first conceived by Motorola.

62. According to the Hytera Defendants, these unlawfully used technologies enable customers to, among other things, "double their capacity while leveraging their current spectrum resources,"<sup>46</sup> "connect[] to a larger number of users,"<sup>47</sup> access "scattered repeaters of different

---

<sup>45</sup> See, e.g., <https://www.businesswire.com/news/home/20180717006081/en/Global-DMR-Provider-Hytera-Appeals-Initial-Determination>; <https://www.rrmediagroup.com/Features/FeaturesDetails/FID/879>; <https://www.apnews.com/3ba2de45c6e34f679ec8133c47d99937>.

<sup>46</sup> Game, Set & Match to Hytera at the 2015 US Open, *available at* <https://life.hytera.ca/game-set-match-to-hytera-at-the-2015-us-open-97721563b1ba#.6w0qr33q9>

frequency bands,”<sup>48</sup> and “enhance the listening experience.”<sup>49</sup> By extensively using Motorola’s patented technologies, the Hytera Defendants avoided the investments and costs that would have been necessary to develop competing technologies on their own, and knew as well that the features they could now offer customers were precisely what those customers hoped to see.

63. Hytera Corporation’s personnel, including at least G.S. Kok, Y.T. Kok, and Samuel Chia—who worked at Motorola during the development of several of the patented technologies—were aware that the technologies they took from Motorola were subject to United States patents. For example, several of the Motorola inventors on the Patents-in-Suit worked with the departing employees and told at least Samuel Chia about their inventions. And the brazen downloading of thousands of Motorola technical documents even included patent documentation related to at least several of the Patents-in-Suit. In addition, because the Hytera Defendants have misappropriated and incorporated Motorola’s patented technology into their own products, a customer’s routine and typical use of those products will practice the methods and implement the systems protected by Motorola’s patents. In fact, the Hytera Defendants have developed and distributed manuals, white papers, and other guidance materials that instruct buyers as to the operation of the Hytera Defendants’ products in accordance with Motorola’s patented technologies. As a result, Hytera Corporation and Hytera America West intended and currently intend that the customers of their digital radio products practice the methods and implement the systems protected by Motorola’s patents.

---

<sup>47</sup> Hytera Extended Pseudo Trunk, *available at* <http://www.hytera.com/product/newDetail/6019.html>

<sup>48</sup> Hytera DMR Series Products Introduction, *available at* [www.dmr-applications.com/16352](http://www.dmr-applications.com/16352)

<sup>49</sup> Hytera DMR Conventional Series Release Notes, *available at* [http://www.hytera.us/Download/Private/file/WebFiles/WF\\_Software%20Release%20Notes\\_R5.0\\_Revised.pdf](http://www.hytera.us/Download/Private/file/WebFiles/WF_Software%20Release%20Notes_R5.0_Revised.pdf)



64. By this action, Motorola seeks to stop the Hytera Defendants' willful, unauthorized, and improper manufacturing, use, sales, offering for sales, and/or importation of Motorola's patented technologies, and to obtain damages for the significant harm caused to Motorola by the Hytera Defendants' willful infringement to date.

**COUNT I — INFRINGEMENT OF THE '284 PATENT**

65. Motorola incorporates and re-alleges Paragraphs 1 through 64 of this Amended Complaint as if fully set forth herein.

66. The USPTO duly and legally issued the '284 Patent on February 14, 2012.

67. Hytera Corporation has infringed, and continues to infringe, one or more claims of the '284 Patent, including at least claim 1, either literally or under the doctrine of equivalents, by importing into the United States products that are covered by one or more claims of the '284 Patent. These products include, but are not limited to, the BD302, BD302i, BD502, BD502i, BD552i, PD362, PD362i, PD402i, PD412, PD412i, PD502, PD502i, PD562, PD562i, PD602/PD602G, PD602i, PD662/PD662G, PD662i, PD682/PD682G, PD682i, PD702/PD702G, PD702G UL913, PD702i, PD752/PD752G, PD752i, PD782/PD782G, PD782 UL913, PD782i, PD792 EX, PD792i, PD982, PD982i, PDC760, X1e, X1ei, X1p, X1pi, MD612i, MD622i, MD652/MD652G, MD652i, MD782/MD782, MD782i, PDC760, RD662, RD662i, RD962, RD982, RD982i, RD982S, RD982Si, and RD982AN products, including products implementing "Pseudo-trunking" and/or "Extended Pseudo Trunk" (XPT) functionality.

68. Hytera Corporation has had knowledge of the '284 Patent since its issuance in 2012. The '284 Patent was conceived by the beginning of 2008 by Motorola engineers Kim Wei Wong, Hooi Hoon Ch'ng, Lip Hong Lim, and Chun Yee Tan. One or more of these inventors told Samuel Chia, then a Motorola employee working in the same location as the inventors,

about their invention. Samuel Chia became a Software Engineering Director at Hytera Corporation working on the accused products. Samuel Chia's responsibilities at Hytera Corporation also encompassed reviewing and understanding the intellectual property related to commercial radio technology; in fact, Samuel Chia has discussed and identified a specific Motorola patent in a publicly available presentation made on behalf of Hytera Corporation.<sup>50</sup> Since 2008, Hytera Corporation's employees, including at least the former Motorola engineers, have also reviewed and monitored the issuance of Motorola patents related to commercial radio technology, including the '284 Patent. Hytera Corporation also has had knowledge of the '284 Patent at least as the result of the filing of the original Complaint in this action.

69. In addition to directly infringing the '284 Patent, Hytera Corporation has indirectly infringed and continues to indirectly infringe one or more claims of the '284 Patent, including at least claim 1, by actively inducing others to directly infringe the '284 Patent in violation of 35 U.S.C. § 271(b). Specifically, and in light of the knowledge of the '284 Patent by Hytera Corporation, Hytera Corporation has induced infringement of the '284 Patent with specific intent to do so, by its activities relating to the importation of its products to its purchasers, including but not limited to the BD302, BD302i, BD502, BD502i, BD552i, PD362, PD362i, PD402i, PD412, PD412i, PD502, PD502i, PD562, PD562i, PD602/PD602G, PD602i, PD662/PD662G, PD662i, PD682/PD682G, PD682i, PD702/PD702G, PD702G UL913, PD702i, PD752/PD752G, PD752i, PD782/PD782G, PD782 UL913, PD782i, PD792 EX, PD792i, PD982, PD982i, PDC760, X1e, X1ei, X1p, X1pi, MD612i, MD622i, MD652/MD652G, MD652i, MD782/MD782, MD782i, PDC760, RD662, RD662i, RD962, RD982, RD982i, RD982S, RD982Si, and RD982AN products, and by instructing and encouraging purchasers,

---

<sup>50</sup> See Samuel Chia, *DMR Protocol Introduction*, (April 8, 2009), <https://www.slideserve.com/regina-clements/dmr-protocol-introduction>.

distributors, and consumers (including through product documentation) to operate and use those products in an infringing manner with knowledge that these actions would infringe the '284 Patent. Indeed, ALJ McNamara determined that “[r]ecord evidence establishes that Hytera [Corporation] actively encourages, advertises, directs, intends, and teaches third parties to infringe the claims of the '284 patent.”<sup>51</sup> Training materials from Hytera Corporation explain how to configure XPT and Pseudo Trunking in an infringing manner.<sup>52</sup>

70. Additionally, Hytera Corporation has contributed to the infringement of the '284 Patent by importing into the United States products, including but not limited to the BD302, BD302i, BD502, BD502i, BD552i, PD362, PD362i, PD402i, PD412, PD412i, PD502, PD502i, PD562, PD562i, PD602/PD602G, PD602i, PD662/PD662G, PD662i, PD682/PD682G, PD682i, PD702/PD702G, PD702G UL913, PD702i, PD752/PD752G, PD752i, PD782/PD782G, PD782 UL913, PD782i, PD792 EX, PD792i, PD982, PD982i, PDC760, X1e, X1ei, X1p, X1pi, MD612i, MD622i, MD652/MD652G, MD652i, MD782/MD782, MD782i, PDC760, RD662, RD662i, RD962, RD982, RD982i, RD982S, RD982Si, and RD982AN products, that constitute a material part of the '284 Patent claimed inventions, that are especially made and/or adapted for infringing the '284 Patent and are not staple articles of commerce suitable for substantial non-infringing use and that have been sold to purchasers who infringe the '284 Patent.<sup>53</sup> Specifically, Hytera Corporation had knowledge that its products, including but not limited to the BD302, BD302i, BD502, BD502i, BD552i, PD362, PD362i, PD402i, PD412, PD412i, PD502, PD502i, PD562, PD562i, PD602/PD602G, PD602i, PD662/PD662G, PD662i, PD682/PD682G, PD682i, PD702/PD702G, PD702G UL913, PD702i, PD752/PD752G, PD752i, PD782/PD782G, PD782

---

<sup>51</sup> Exhibit 12, *Certain Two-Way Radio Equipment and Systems, Related Software and Components Thereof*, Initial Determination on Violation of Section 337 and Recommended Determination on Remedy and Bond (Public Version), Inv. No. 337-TA-1053 at 227.

<sup>52</sup> *Id.*

<sup>53</sup> *Id.* at 228.

UL913, PD782i, PD792 EX, PD792i, PD982, PD982i, PDC760, X1e, X1ei, X1p, X1pi, MD612i, MD622i, MD652/MD652G, MD652i, MD782/MD782, MD782i, PDC760, RD662, RD662i, RD962, RD982, RD982i, RD982S, RD982Si, and RD982AN products, were specifically made and/or adapted for infringement of the '284 Patent and are not staple articles of commerce suitable for substantial noninfringing use.

71. Hytera America West has infringed, and continues to infringe, one or more claims of the '284 Patent, including at least claim 1, either literally or under the doctrine of equivalents, by making, using, selling, and/or offering for sale within the United States and/or importing into the United States products that are covered by one or more claims of the '284 Patent. These products include, but are not limited to, the BD302, BD302i, BD502, BD502i, BD552i, PD362, PD362i, PD402i, PD412, PD412i, PD502, PD502i, PD562, PD562i, PD602/PD602G, PD602i, PD662/PD662G, PD662i, PD682/PD682G, PD682i, PD702/PD702G, PD702G UL913, PD702i, PD752/PD752G, PD752i, PD782/PD782G, PD782 UL913, PD782i, PD792 EX, PD792i, PD982, PD982i, PDC760, X1e, X1ei, X1p, X1pi, MD612i, MD622i, MD652/MD652G, MD652i, MD782/MD782, MD782i, PDC760, RD662, RD662i, RD962, RD982, RD982i, RD982S, RD982Si, and RD982AN products, including products implementing "Pseudo-trunking" and/or "Extended Pseudo Trunk" (XPT) functionality.

72. Hytera America West has had knowledge of the '284 Patent since Hytera Corporation established Hytera America West in March 2016. Employees of Hytera Corporation, who established Hytera America West in March 2016, have also reviewed and monitored the issuance of Motorola patents related to commercial radio technology, including the '284 Patent. Hytera America West also has had knowledge of the '284 Patent at least as the result of the filing of the original Complaint in this action.

73. In addition to directly infringing the '284 Patent, Hytera America West has indirectly infringed and continues to indirectly infringe one or more claims of the '284 Patent, including at least claim 1, by actively inducing others to directly infringe the '284 Patent in violation of 35 U.S.C. § 271(b). Specifically, Hytera America West has induced infringement of the '284 Patent with specific intent to do so, by its activities relating to the marketing, distribution, and/or sale of its products to its purchasers, including but not limited to the BD302, BD302i, BD502, BD502i, BD552i, PD362, PD362i, PD402i, PD412, PD412i, PD502, PD502i, PD562, PD562i, PD602/PD602G, PD602i, PD662/PD662G, PD662i, PD682/PD682G, PD682i, PD702/PD702G, PD702G UL913, PD702i, PD752/PD752G, PD752i, PD782/PD782G, PD782 UL913, PD782i, PD792 EX, PD792i, PD982, PD982i, PDC760, X1e, X1ei, X1p, X1pi, MD612i, MD622i, MD652/MD652G, MD652i, MD782/MD782, MD782i, PDC760, RD662, RD662i, RD962, RD982, RD982i, RD982S, RD982Si, and RD982AN products, and by instructing and encouraging purchasers, distributors, and consumers (including through product documentation) to operate and use those products in an infringing manner with knowledge that these actions would infringe the '284 Patent. Indeed, ALJ McNamara determined that “[r]ecord evidence establishes that Hytera [America West] actively encourages, advertises, directs, intends, and teaches third parties to infringe the claims of the '284 patent.”<sup>54</sup> Training materials from Hytera America West explain how to configure XPT and Pseudo Trunking in an infringing manner.<sup>55</sup>

74. Additionally, Hytera America West has contributed to infringement of the '284 Patent by others by selling and/or offering for sale to Hytera America West's purchasers within the United States and/or importing into the United States products, including but not limited to

---

<sup>54</sup> *Id.* at 227.

<sup>55</sup> *Id.*

the BD302, BD302i, BD502, BD502i, BD552i, PD362, PD362i, PD402i, PD412, PD412i, PD502, PD502i, PD562, PD562i, PD602/PD602G, PD602i, PD662/PD662G, PD662i, PD682/PD682G, PD682i, PD702/PD702G, PD702G UL913, PD702i, PD752/PD752G, PD752i, PD782/PD782G, PD782 UL913, PD782i, PD792 EX, PD792i, PD982, PD982i, PDC760, X1e, X1ei, X1p, X1pi, MD612i, MD622i, MD652/MD652G, MD652i, MD782/MD782, MD782i, PDC760, RD662, RD662i, RD962, RD982, RD982i, RD982S, RD982Si, and RD982AN products, that constitute a material part of the '284 Patent claimed inventions, that are especially made and/or adapted for infringing the '284 Patent and are not staple articles of commerce suitable for substantial non-infringing use and that have been sold to purchasers who infringe the '284 Patent.<sup>56</sup> Specifically, Hytera America West had knowledge that its products, including but not limited to the BD302, BD302i, BD502, BD502i, BD552i, PD362, PD362i, PD402i, PD412, PD412i, PD502, PD502i, PD562, PD562i, PD602/PD602G, PD602i, PD662/PD662G, PD662i, PD682/PD682G, PD682i, PD702/PD702G, PD702G UL913, PD702i, PD752/PD752G, PD752i, PD782/PD782G, PD782 UL913, PD782i, PD792 EX, PD792i, PD982, PD982i, PDC760, X1e, X1ei, X1p, X1pi, MD612i, MD622i, MD652/MD652G, MD652i, MD782/MD782, MD782i, PDC760, RD662, RD662i, RD962, RD982, RD982i, RD982S, RD982Si, and RD982AN products, were specifically made and/or adapted for infringement of the '284 Patent and are not staple articles of commerce suitable for substantial noninfringing use.

75. For example, the Hytera Defendants have infringed, and continue to infringe, at least claim 1 of the '284 Patent:

1. A method for temporarily selecting a time division multiple access (TDMA) timeslot by a radio communication device to thereby allow the radio communication device to communicate,

---

<sup>56</sup> *Id.*

through at least one repeater station, with a talkgroup of other radio communication devices, the method comprising:

the radio communication device having an assigned default timeslot for communicating with the talkgroup;

the radio communication device determining if the default timeslot is available for the radio communication device to communicate with the talkgroup;

the radio communication device searching for an available timeslot when the default timeslot is unavailable;

the radio communication device temporarily selecting the available timeslot as a temporary selected group timeslot for the talkgroup; and

the radio communication device re-selecting the default timeslot for communicating with the talkgroup when the default timeslot becomes available.

76. The accused products implement a “method for temporarily selecting a time division multiple access (TDMA) timeslot by a radio communication device to thereby allow the radio communication device to communicate, through at least one repeater station, with a talkgroup of other radio communication devices.” One of the Hytera Defendants’ documents, for example, describes that the XPT system “temporarily provides available channels to initiate a call” to the radio communication device. Hytera XPT Digital Trunking Brochure (“XPT Digital Trunking”) at 3. This document also illustrates that the accused radios communicate through at least one repeater station with a talkgroup of other radio communication devices, as shown below:

The radio / group is moved to the free repeater to initiate a call.

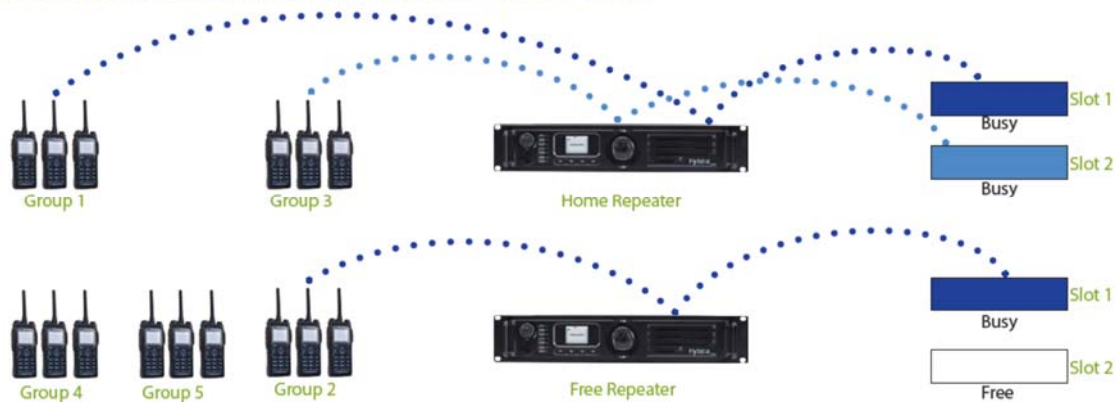

77. The accused products also are “radio communication devices” that have “an assigned default timeslot for communicating with the talkgroup.” For example, Hytera’s XPT Digital Trunking System Technology White Paper (“XPT White Paper”) explains that “the radios will be allocated with a specific frequency and slot in advance.” XPT White Paper at 4.

78. In addition, the accused products “determin[e] if the default timeslot is available for the radio communication device to communicate with the talkgroup.” For example, the XPT White Paper explains that an “idle radio always monitors its idle home repeater . . . . In the case of a busy channel, the radio can switch to an available channel and slot to communicate.” XPT White Paper at 4.

79. The accused products also “search[] for an available timeslot when the default timeslot is unavailable.” For example, the XPT White Paper states that “[t]he home repeater will broadcast the XPT system’s status information in each frequency via a beacon signal. This informs the radio of available channel resources. In the case of a busy channel, the radio can switch to an available channel and slot to communicate.” XPT White Paper at 4.

80. The accused products further “temporarily select[] the available timeslot as a temporary selected group timeslot for the talkgroup.” For example, a Hytera document describes



that the XPT system “temporarily provides available channels to initiate a call” to the radio communication device. XPT Digital Trunking at 3.

81. The accused products “re-select[] the default timeslot for communicating with the talkgroup when the default timeslot becomes available.” A Hytera document, for example, describes that “[o]nce the home repeater has an available resource the group of radios will switch back to it.” XPT Digital Trunking at 3.

82. It is worth noting that ALJ McNamara adopted Motorola’s proposed claim interpretation of the ’284 Patent in Inv. No. 337-TA-1053.<sup>57</sup>

83. The Hytera Defendants’ infringement has caused and is continuing to cause damage and irreparable injury to Motorola, and Motorola will continue to suffer damage and irreparable injury unless and until that infringement is enjoined by this Court.

84. Motorola is entitled to injunctive relief and damages in accordance with 35 U.S.C. §§ 271, 281, 283, and 284.

85. The Hytera Defendants have infringed the ’284 Patent as alleged above, despite having prior knowledge of the patent, and have acted with willful, intentional, and conscious disregard of the objectively high likelihood that their acts constitute infringement of the ’284 Patent. Indeed, as previously alleged, the Hytera Defendants intentionally and knowingly misappropriated and copied proprietary innovations developed and patented by Motorola, including technology that the Hytera Defendants now market as their own “Pseudo-trunking” and “Extended Pseudo Trunk” technology. This conduct is egregious and constitutes willful infringement under 35 U.S.C. § 284, entitling Motorola to enhanced damages.

---

<sup>57</sup> Exhibit 17, *Certain Two-Way Radio Equipment and Systems, Related Software and Components Thereof*, Construing Certain Terms of the Asserted Claims of the Patents at Issue [Markman Claim Construction], Inv. No. 337-TA-1053, Chart 1 at 1-20.

**COUNT II — INFRINGEMENT OF THE '169 PATENT**

86. Motorola incorporates and re-alleges Paragraphs 1 through 85 of this Amended Complaint as if fully set forth herein.

87. The USPTO duly and legally issued the '169 Patent on October 4, 2011.

88. Hytera Corporation has infringed, and continue to infringe, one or more claims of the '169 Patent, including at least claim 1, either literally or under the doctrine of equivalents, by importing into the United States products that are covered by one or more claims of the '169 Patent. These products include, but are not limited to, the BD302, BD302i, BD502, BD502i, BD552i, PD362, PD362i, PD402i, PD412, PD412i, PD502, PD502i, PD562, PD562i, PD602/PD602G, PD602i, PD662/PD662G, PD662i, PD682/PD682G, PD682i, PD702/PD702G, PD702G UL913, PD702i, PD752/PD752G, PD752i, PD782/PD782G, PD782 UL913, PD782i, PD792 EX, PD792i, PD982, PD982i, PDC760, X1e, X1ei, X1p, X1pi, MD612i, MD622i, MD652/MD652G, MD652i, MD782/MD782, MD782i, PDC760, RD662, RD662i, RD962, RD982, RD982i, RD982S, RD982Si, and RD982AN products, including products implementing the "IP Multi-Site Connect" functionality.

89. Hytera Corporation has had knowledge of the '169 Patent since its issuance in 2011. The application for the '169 Patent was filed before Samuel Chia, G.S. Kok, and Y.T. Kok left Motorola, and documentation regarding that application was downloaded by one or more of the former Motorola employees before departing. Samuel Chia became a Software Engineering Director at Hytera Corporation working on the accused products. On information and belief, Samuel Chia's responsibilities at Hytera Corporation also encompassed reviewing and understanding the intellectual property related to commercial radio technology; in fact, Samuel Chia has discussed and identified a specific Motorola patent in a publicly available

presentation made on behalf of Hytera Corporation.<sup>58</sup> Since 2008, Hytera Corporation's employees, including at least the former Motorola employees, have also reviewed and monitored the issuance of Motorola patents related to commercial radio technology, including the '169 Patent. Hytera Corporation also has had knowledge of the '169 Patent at least as the result of the filing of the original Complaint in this action.

90. In addition to directly infringing the '169 Patent, Hytera Corporation has indirectly infringed and continues to indirectly infringe one or more claims of the '169 Patent, including at least claim 1, by actively inducing others to directly infringe the '169 Patent in violation of 35 U.S.C. § 271(b). Specifically, and in light of the knowledge of the '169 Patent by Hytera Corporation, Hytera Corporation knowingly induced infringement of the '169 Patent with specific intent to do so by its activities relating to the importation of its products to its purchasers, including but not limited to the BD302, BD302i, BD502, BD502i, BD552i, PD362, PD362i, PD402i, PD412, PD412i, PD502, PD502i, PD562, PD562i, PD602/PD602G, PD602i, PD662/PD662G, PD662i, PD682/PD682G, PD682i, PD702/PD702G, PD702G UL913, PD702i, PD752/PD752G, PD752i, PD782/PD782G, PD782 UL913, PD782i, PD792 EX, PD792i, PD982, PD982i, PDC760, X1e, X1ei, X1p, X1pi, MD612i, MD622i, MD652/MD652G, MD652i, MD782/MD782, MD782i, PDC760, RD662, RD662i, RD962, RD982, RD982i, RD982S, RD982Si, and RD982AN products, and by instructing and encouraging purchasers (including through product documentation) to operate and use those products in an infringing manner with knowledge that these actions would infringe the '169 Patent.

91. Hytera Corporation has also contributed to infringement of the '169 Patent by others by importing into the United States products, including but not limited to the BD302,

---

<sup>58</sup> See Samuel Chia, *DMR Protocol Introduction*, (April 8, 2009), <https://www.slideserve.com/regina-clements/dmr-protocol-introduction>.

BD302i, BD502, BD502i, BD552i, PD362, PD362i, PD402i, PD412, PD412i, PD502, PD502i, PD562, PD562i, PD602/PD602G, PD602i, PD662/PD662G, PD662i, PD682/PD682G, PD682i, PD702/PD702G, PD702G UL913, PD702i, PD752/PD752G, PD752i, PD782/PD782G, PD782 UL913, PD782i, PD792 EX, PD792i, PD982, PD982i, PDC760, X1e, X1ei, X1p, X1pi, MD612i, MD622i, MD652/MD652G, MD652i, MD782/MD782, MD782i, PDC760, RD662, RD662i, RD962, RD982, RD982i, RD982S, RD982Si, and RD982AN products, that constitute a material part of the '169 Patent claimed inventions, that are especially made and/or adapted for infringing the '169 Patent and are not staple articles of commerce suitable for substantial non-infringing use and that have been sold to purchasers who infringe the '169 Patent. Specifically, and in light of the knowledge of the '169 Patent by Hytera Corporation as previously alleged, Hytera Corporation had knowledge that its products, including but not limited to the BD302, BD302i, BD502, BD502i, BD552i, PD362, PD362i, PD402i, PD412, PD412i, PD502, PD502i, PD562, PD562i, PD602/PD602G, PD602i, PD662/PD662G, PD662i, PD682/PD682G, PD682i, PD702/PD702G, PD702G UL913, PD702i, PD752/PD752G, PD752i, PD782/PD782G, PD782 UL913, PD782i, PD792 EX, PD792i, PD982, PD982i, PDC760, X1e, X1ei, X1p, X1pi, MD612i, MD622i, MD652/MD652G, MD652i, MD782/MD782, MD782i, PDC760, RD662, RD662i, RD962, RD982, RD982i, RD982S, RD982Si, and RD982AN products, were specifically made and/or adapted for infringement of the '169 Patent and are not staple articles of commerce suitable for substantial noninfringing use.

92. Hytera America West has infringed, and continue to infringe, one or more claims of the '169 Patent, including at least claim 1, either literally or under the doctrine of equivalents, by making, using, selling, and/or offering for sale within the United States and/or importing into the United States products that are covered by one or more claims of the '169 Patent. These

products include, but are not limited to, the BD302, BD302i, BD502, BD502i, BD552i, PD362, PD362i, PD402i, PD412, PD412i, PD502, PD502i, PD562, PD562i, PD602/PD602G, PD602i, PD662/PD662G, PD662i, PD682/PD682G, PD682i, PD702/PD702G, PD702G UL913, PD702i, PD752/PD752G, PD752i, PD782/PD782G, PD782 UL913, PD782i, PD792 EX, PD792i, PD982, PD982i, PDC760, X1e, X1ei, X1p, X1pi, MD612i, MD622i, MD652/MD652G, MD652i, MD782/MD782, MD782i, PDC760, RD662, RD662i, RD962, RD982, RD982i, RD982S, RD982Si, and RD982AN products, including products implementing the “IP Multi-Site Connect” functionality.

93. Hytera America West has had knowledge of the '169 Patent since Hytera Corporation established Hytera America West in March 2016. Employees of Hytera Corporation, who established Hytera America West in March 2016, have also reviewed and monitored the issuance of Motorola patents related to commercial radio technology, including the '169 Patent. Hytera America West also has had knowledge of the '169 Patent at least as the result of the filing of the original Complaint in this action.

94. In addition to directly infringing the '169 Patent, Hytera America West has indirectly infringed and continues to indirectly infringe one or more claims of the '169 Patent, including at least claim 1, by actively inducing others to directly infringe the '169 Patent in violation of 35 U.S.C. § 271(b). Specifically, and in light of the knowledge of the '169 Patent by Hytera America West, Hytera America West knowingly induced infringement of the '169 Patent with specific intent to do so by its activities relating to the marketing, distribution, and/or sale of its products to its purchasers, including but not limited to the BD302, BD302i, BD502, BD502i, BD552i, PD362, PD362i, PD402i, PD412, PD412i, PD502, PD502i, PD562, PD562i, PD602/PD602G, PD602i, PD662/PD662G, PD662i, PD682/PD682G, PD682i, PD702/PD702G,

PD702G UL913, PD702i, PD752/PD752G, PD752i, PD782/PD782G, PD782 UL913, PD782i, PD792 EX, PD792i, PD982, PD982i, PDC760, X1e, X1ei, X1p, X1pi, MD612i, MD622i, MD652/MD652G, MD652i, MD782/MD782, MD782i, PDC760, RD662, RD662i, RD962, RD982, RD982i, RD982S, RD982Si, and RD982AN products, and by instructing and encouraging purchasers (including through product documentation) to operate and use those products in an infringing manner with knowledge that these actions would infringe the '169 Patent.

95. Hytera America West has also contributed to infringement of the '169 Patent by others by selling and/or offering for sale to Hytera America West's purchasers within the United States and/or importing into the United States products, including but not limited to the BD302, BD302i, BD502, BD502i, BD552i, PD362, PD362i, PD402i, PD412, PD412i, PD502, PD502i, PD562, PD562i, PD602/PD602G, PD602i, PD662/PD662G, PD662i, PD682/PD682G, PD682i, PD702/PD702G, PD702G UL913, PD702i, PD752/PD752G, PD752i, PD782/PD782G, PD782 UL913, PD782i, PD792 EX, PD792i, PD982, PD982i, PDC760, X1e, X1ei, X1p, X1pi, MD612i, MD622i, MD652/MD652G, MD652i, MD782/MD782, MD782i, PDC760, RD662, RD662i, RD962, RD982, RD982i, RD982S, RD982Si, and RD982AN products, that constitute a material part of the '169 Patent claimed inventions, that are especially made and/or adapted for infringing the '169 Patent and are not staple articles of commerce suitable for substantial non-infringing use and that have been sold to purchasers who infringe the '169 Patent. Specifically, and in light of the knowledge of the '169 Patent by Hytera America West as previously alleged, Hytera America West had knowledge that its products, including but not limited to the BD302, BD302i, BD502, BD502i, BD552i, PD362, PD362i, PD402i, PD412, PD412i, PD502, PD502i, PD562, PD562i, PD602/PD602G, PD602i, PD662/PD662G, PD662i, PD682/PD682G, PD682i,

PD702/PD702G, PD702G UL913, PD702i, PD752/PD752G, PD752i, PD782/PD782G, PD782 UL913, PD782i, PD792 EX, PD792i, PD982, PD982i, PDC760, X1e, X1ei, X1p, X1pi, MD612i, MD622i, MD652/MD652G, MD652i, MD782/MD782, MD782i, PDC760, RD662, RD662i, RD962, RD982, RD982i, RD982S, RD982Si, and RD982AN products, were specifically made and/or adapted for infringement of the '169 Patent and are not staple articles of commerce suitable for substantial noninfringing use.

96. For example, the Hytera Defendants have infringed, and continue to infringe, at least claim 1 of the '169 Patent:

1. A system for providing low overhead floor control in a distributed control two-way radio communications network comprising:

a plurality of subscriber stations; and

a plurality of peer stations interconnected via an Internet connection using no central control,

wherein at least one subscriber station of the plurality of subscriber stations utilizes a floor request during a timed interval for requesting floor control to at least one peer station, and

wherein at least one of:

the timed interval is set at approximately twice the expected maximum message delay between a first peer and a second peer,

the at least one peer station utilizes a hang time for providing the plurality of subscribers a period to reply to a message sent by the at least one subscriber station without losing floor control, or

each of the plurality of peer stations receive an identical set of floor requests as every other peer within the timed interval.

97. The accused products comprise a “system for providing low overhead floor control in a distributed control two-way radio communications network.” For example, the IP Multi-Site Connect functionality connects “two or more conventional communication systems in different areas.” Hytera DMR System Planner at 135-36. “In IP Multi-site Connect system,

when one repeater receives service requests from the radio, it will transfer them to each repeater in the system over IP network to determine whether the access is granted.” *Id.* at 147.

98. The accused products comprise “a plurality of subscriber stations.” For example, the Hytera DMR System Planner illustrates a representative system running IP Multi-site Connect with a plurality of subscribers:

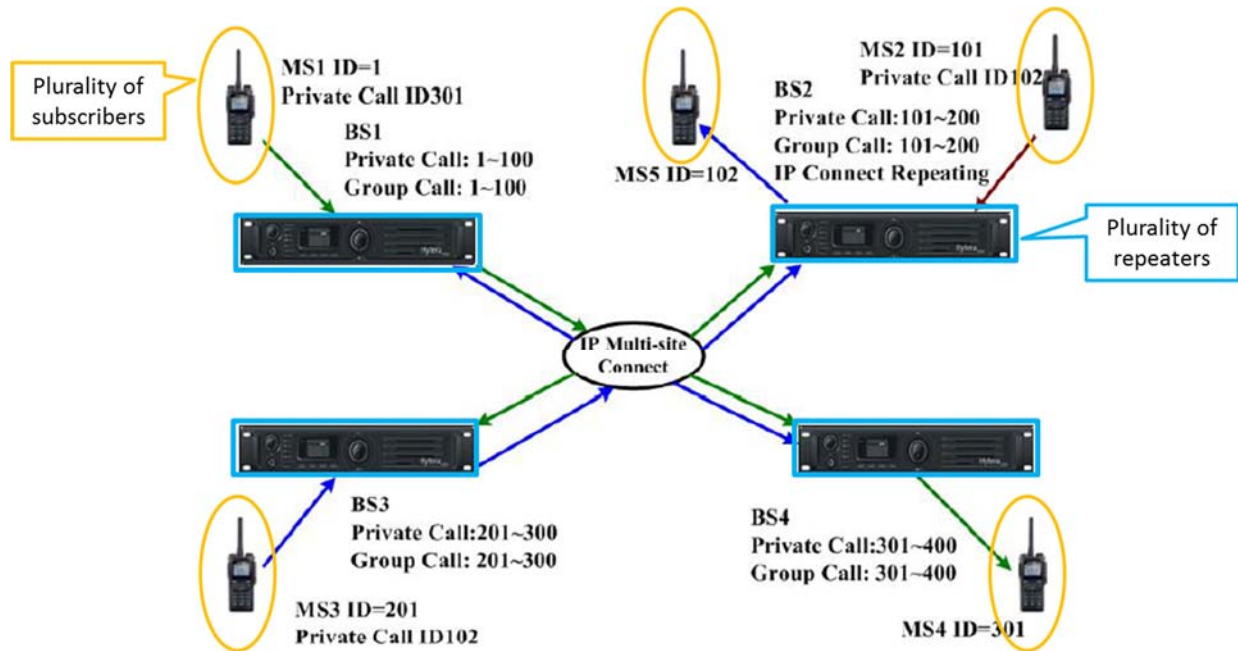

Figure 4.4.2-3: Multi-site Access Management Example

*Id.* at 151.<sup>59</sup>

99. The accused products also comprise “a plurality of peer stations interconnected via an Internet connection using no central control.” For example, as shown above, a representative system running IP Multi-site Connect includes a plurality of peer stations, or “repeaters,” “in dispersed locations over a TCP/IP-based network.” Hytera DMR System Planner at 135. There is no central control in the accused products. For example, “[f]or IP Multi-site Connect network, there is no independent exchange center or server.” *Id.* at 166.

<sup>59</sup> Highlighting and other notations in the excerpted documents have been added unless otherwise noted.



100. In the accused products, “at least one subscriber station of the plurality of subscriber stations utilizes a floor request during a timed interval for requesting floor control to at least one peer station.” For example, each Hytera repeater can receive floor requests from subscribers. An exemplary repeater specifically “will receive the data from the network and the signals over the air” and has to determine what to transfer first when it “receives both at the same time.” Hytera DMR System Planner at 152. The repeaters can, for example, implement “Repeat request priority” to “define the priority to the signals or data to be transferred by the repeater.” See Hytera Customer Programming Software.

101. Each accused product also, for example, implements a timed interval for requesting floor control. For example, the Customer Programming Software for the RD982 describes that the repeater may “respond[] to the Local Repeating request first” or may “respond[] to the IP Connect Repeating request first,” as opposed to implementing a First Come First Send priority.

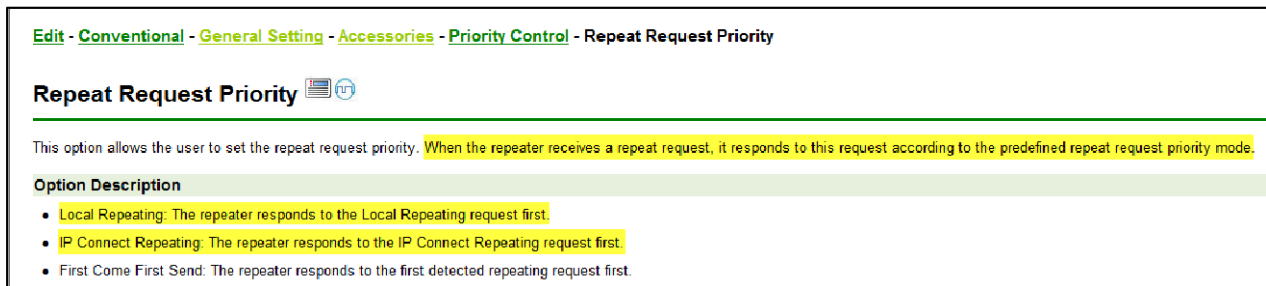

Screenshot of RD982 Customer Programming Software.

102. In the accused products, “at least one of: the timed interval is set at approximately twice the expected maximum message delay between a first peer and a second peer, the at least one peer station utilizes a hang time for providing the plurality of subscribers a period to reply to a message sent by the at least one subscriber station without losing floor control, or each of the plurality of peer stations receive an identical set of floor requests as every other peer within the

timed interval.” For example, the accused products implement a group call hangtime at each repeater for providing subscribers a period to reply to a message without losing floor control. The Hytera DMR System Planner describes the “Group call hang time,” which “set[s] the duration the radio stays at in\_call status after a group call transmission.” Hytera DMR System Planner at 116.

103. As another example, in the accused products, each of the plurality of peer stations receives an identical set of floor requests as every other peer within the timed interval. A Hytera repeater, for example, that “receives service requests from the radio . . . will transfer them to each repeater in the system over IP network to determine whether the access is granted.” *Id.* at 147.

104. The Hytera Defendants’ infringement has caused and is continuing to cause damage and irreparable injury to Motorola, and Motorola will continue to suffer damage and irreparable injury unless and until that infringement is enjoined by this Court.

105. Motorola is entitled to injunctive relief and damages in accordance with 35 U.S.C. §§ 271, 281, 283, and 284.

106. The Hytera Defendants have infringed the ’169 Patent as alleged above, despite having prior knowledge of the patent and have acted with willful, intentional, and conscious disregard of the objectively high likelihood that their acts constitute infringement of the ’169 Patent. Indeed, as previously alleged, the Hytera Defendants intentionally and knowingly misappropriated and copied proprietary innovations developed and patented by Motorola, including technology that the Hytera Defendants now market as their own IP Multi-Site Connect technology. This conduct is egregious and constitutes willful infringement under 35 U.S.C. § 284, entitling Motorola to enhanced damages.

**COUNT III — INFRINGEMENT OF THE '869 PATENT**

107. Motorola incorporates and re-alleges Paragraphs 1 through 106 of this Amended Complaint as if fully set forth herein.

108. The USPTO duly and legally issued the '869 Patent on May 6, 2008.

109. Hytera Corporation has infringed one or more claims of the '869 Patent, including at least claim 21, either literally or under the doctrine of equivalents, by importing into the United States products that are covered by one or more claims of the '869 Patent. These products include, but are not limited to, the RD662, RD962, RD982, RD982S, RD982AN, BD302, BD502, PD362, PD412, PD502, PD562, PD602/PD602G, PD662/PD662G, PD682/PD682G, PD702/PD702G, PD702G UL913, PD752/PD752G, PD782/PD782G, PD782 UL913, PD792 EX, PD982, X1e, X1p, MD652/MD652G, and MD782/MD782 products, including products implementing scan functionality.

110. Hytera Corporation has had knowledge of the '869 Patent since its issuance in 2008. The '869 Patent issued before at least Samuel Chia and Y.T. Kok left Motorola, and documentation regarding that '869 Patent was downloaded by one or more of the former Motorola employees before departing. Samuel Chia became a Software Engineering Director at Hytera Corporation working on the accused products. Samuel Chia's responsibilities at Hytera Corporation also encompassed reviewing and understanding the intellectual property related to commercial radio technology; in fact, Samuel Chia has discussed and identified a specific Motorola patent in a publicly available presentation made on behalf of Hytera Corporation.<sup>60</sup> Since 2008, Hytera Corporation's employees, including at least the former Motorola employees, have also reviewed and monitored the issuance of Motorola patents related to commercial radio

---

<sup>60</sup> See Samuel Chia, *DMR Protocol Introduction*, (April 8, 2009), <https://www.slideserve.com/regina-clements/dmr-protocol-introduction>.

technology, including the '869 Patent. Hytera Corporation also has had knowledge of the '869 Patent at least as the result of the filing of the original Complaint in this action.

111. In addition to directly infringing the '869 Patent, Hytera Corporation has indirectly infringed one or more claims of the '869 Patent, including at least claim 21, by actively inducing others to directly infringe the '869 Patent in violation of 35 U.S.C. § 271(b). Specifically, and in light of the knowledge of the '869 Patent by Hytera Corporation, Hytera Corporation knowingly induced infringement of the '869 Patent with specific intent to do so by its activities relating to the importation of its products to its purchasers, including but not limited to the RD662, RD962, RD982, RD982S, RD982AN, BD302, BD502, PD362, PD412, PD502, PD562, PD602/PD602G, PD662/PD662G, PD682/PD682G, PD702/PD702G, PD702G UL913, PD752/PD752G, PD782/PD782G, PD782 UL913, PD792 EX, PD982, X1e, X1p, MD652/MD652G, and MD782/MD782 products, and by instructing and encouraging purchasers (including through product documentation) to operate and use those products in an infringing manner with knowledge that these actions would infringe the '869 Patent. Indeed, ALJ McNamara determined that “[r]ecord evidence provided in this Investigation demonstrates that Hytera [Corporation] actively encourages, advertises, directs, intends, and teaches third parties to infringe the claims of the '869 patent, including by describing how to configure the scan feature in an infringing manner.”<sup>61</sup> Training materials from Hytera Corporation explain how to configure the scan functionality in an infringing manner.<sup>62</sup> Hytera America West employees confirmed that Hytera teaches customers to use the accused features.<sup>63</sup>

---

<sup>61</sup> Exhibit 12, *Certain Two-Way Radio Equipment and Systems, Related Software and Components Thereof*, Initial Determination on Violation of Section 337 and Recommended Determination on Remedy and Bond (Public Version), Inv. No. 337-TA-1053 at 229.

<sup>62</sup> *Id.*

<sup>63</sup> *Id.*

112. Hytera Corporation has also contributed to infringement of the '869 Patent by others by importing into the United States products, including but not limited to the RD662, RD962, RD982, RD982S, RD982AN, BD302, BD502, PD362, PD412, PD502, PD562, PD602/PD602G, PD662/PD662G, PD682/PD682G, PD702/PD702G, PD702G UL913, PD752/PD752G, PD782/PD782G, PD782 UL913, PD792 EX, PD982, X1e, X1p, MD652/MD652G, and MD782/MD782 products, that constitute a material part of the '869 Patent claimed inventions, that are especially made and/or adapted for infringing the '869 Patent, and are not staple articles of commerce suitable for substantial non-infringing use and that have been sold to purchasers who infringe the '869 Patent.<sup>64</sup> Specifically, and in light of the knowledge of the '869 Patent by Hytera Corporation as previously alleged, Hytera Corporation had knowledge that its products, including but not limited to the RD662, RD962, RD982, RD982S, RD982AN, BD302, BD502, PD362, PD412, PD502, PD562, PD602/PD602G, PD662/PD662G, PD682/PD682G, PD702/PD702G, PD702G UL913, PD752/PD752G, PD782/PD782G, PD782 UL913, PD792 EX, PD982, X1e, X1p, MD652/MD652G, and MD782/MD782 products, were specifically made and/or adapted for infringement of the '869 Patent and are not staple articles of commerce suitable for substantial noninfringing use.

113. Hytera America West has infringed one or more claims of the '869 Patent, including at least claim 21, either literally or under the doctrine of equivalents, by making, using, selling, and/or offering for sale within the United States and/or importing into the United States products that are covered by one or more claims of the '869 Patent. These products include, but are not limited to, the RD662, RD962, RD982, RD982S, RD982AN, BD302, BD502, PD362, PD412, PD502, PD562, PD602/PD602G, PD662/PD662G, PD682/PD682G, PD702/PD702G,

---

<sup>64</sup> *Id.* at 229-30.

PD702G UL913, PD752/PD752G, PD782/PD782G, PD782 UL913, PD792 EX, PD982, X1e, X1p, MD652/MD652G, and MD782/MD782 products, including products implementing scan functionality.

114. Hytera America West has had knowledge of the '869 Patent since Hytera Corporation established Hytera America West in March 2016. Employees of Hytera Corporation, who established Hytera America West in March 2016, have also reviewed and monitored the issuance of Motorola patents related to commercial radio technology, including the '869 Patent. Hytera America West also has had knowledge of the '869 Patent at least as the result of the filing of the original Complaint in this action.

115. In addition to directly infringing the '869 Patent, Hytera America West has indirectly infringed one or more claims of the '869 Patent, including at least claim 21, by actively inducing others to directly infringe the '869 Patent in violation of 35 U.S.C. § 271(b). Specifically, and in light of the knowledge of the '869 Patent by Hytera America West, Hytera America West knowingly induced infringement of the '869 Patent with specific intent to do so by its activities relating to the marketing, distribution, and/or sale of its products to its purchasers, including but not limited to the RD662, RD962, RD982, RD982S, RD982AN, BD302, BD502, PD362, PD412, PD502, PD562, PD602/PD602G, PD662/PD662G, PD682/PD682G, PD702/PD702G, PD702G UL913, PD752/PD752G, PD782/PD782G, PD782 UL913, PD792 EX, PD982, X1e, X1p, MD652/MD652G, and MD782/MD782 products, and by instructing and encouraging purchasers (including through product documentation) to operate and use those products in an infringing manner with knowledge that these actions would infringe the '869 Patent. Indeed, ALJ McNamara determined that “[r]ecord evidence provided in this Investigation demonstrates that Hytera [America West] actively encourages, advertises, directs,

intends, and teaches third parties to infringe the claims of the '869 patent, including by describing how to configure the scan feature in an infringing manner.”<sup>65</sup> Training materials from Hytera America West explain how to configure the scan functionality in an infringing manner.<sup>66</sup>

116. Hytera America West has also contributed to infringement of the '869 Patent by others by selling and/or offering for sale to Hytera America West's purchasers within the United States and/or importing into the United States products, including but not limited to the RD662, RD962, RD982, RD982S, RD982AN, BD302, BD502, PD362, PD412, PD502, PD562, PD602/PD602G, PD662/PD662G, PD682/PD682G, PD702/PD702G, PD702G UL913, PD752/PD752G, PD782/PD782G, PD782 UL913, PD792 EX, PD982, X1e, X1p, MD652/MD652G, and MD782/MD782 products, that constitute a material part of the '869 Patent claimed inventions, that are especially made and/or adapted for infringing the '869 Patent and are not staple articles of commerce suitable for substantial non-infringing use and that have been sold to purchasers who infringe the '869 Patent. Specifically, and in light of the knowledge of the '869 Patent by Hytera America West as previously alleged, Hytera America West had knowledge that its products, including but not limited to the RD662, RD962, RD982, RD982S, RD982AN, BD302, BD502, PD362, PD412, PD502, PD562, PD602/PD602G, PD662/PD662G, PD682/PD682G, PD702/PD702G, PD702G UL913, PD752/PD752G, PD782/PD782G, PD782 UL913, PD792 EX, PD982, X1e, X1p, MD652/MD652G, and MD782/MD782 products, were specifically made and/or adapted for infringement of the '869 Patent and are not staple articles of commerce suitable for substantial noninfringing use.

117. For example, the Hytera Defendants have infringed, and continue to infringe, at least claim 21 of the '869 Patent:

---

<sup>65</sup> *Id.*

<sup>66</sup> *Id.*

21. A system for scanning a TDMA channel by a subscriber unit in a wireless communications landscape 100, wherein the subscriber unit is operationally connected to at least one base radio over a plurality of channels, the system comprising:

a receiver for locking onto a channel of the plurality of channels wherein a subset of the plurality of channels is preprogrammed and whereby the receiver obtains an activity update message from the channel wherein the activity update message indicates in a first information activity on the channel and indicates in a second information at least one characteristic of the activity on the channel;

a decoder for obtaining the at least one characteristic from the activity update message;

a comparator which compares the at least one characteristic with third preprogrammed information indicating at least one preprogrammed characteristic to determine whether the activity is of interest to the system;

a selector to receive activity which the comparator determines to be of interest

wherein the operation of the receiver, the decoder, the comparator, and the selector are controlled by a processor.

118. The accused products implement a “system for scanning a TDMA channel by a subscriber unit in a wireless communications landscape 100, wherein the subscriber unit is operationally connected to at least one base radio over a plurality of channels.” For example, the accused radios “are system[s] for scanning a TDMA channel.” “With the Scan feature, the radio can detect the communication activities on other channels and select the channel for staying on according to the scan result.” Hytera DMR System Planner at 36. The accused products can also operate in repeater mode in which the subscriber is operationally connected to at least one base radio over a plurality of channels. *Id.* at 127.

119. The accused products include “a receiver for locking onto a channel of the plurality of channels wherein a subset of the plurality of channels is preprogrammed.” For example, a “Scan List” of preprogrammed channels is configured in the Customer Programming



Software for the accused products. “The radio will scan channels in accordance with the Scan List.” Hytera DMR System Planner at 38.

120. In the accused products, “the receiver obtains an activity update message from the channel wherein the activity update message indicates in a first information activity on the channel and indicates in a second information at least one characteristic of the activity on the channel.” For example, an activity update message can be a Short Link Control (LC) PDU that is carried from the base station by the Common Announcement Channel (CACH) and includes a first information related to activity on each timeslot of a particular frequency and a second information indicating the hashed destination address of the activity on each timeslot.

121. The Hytera Defendants specifically use an activity update message for their scan operations. For example, as shown below, a Hytera presentation by Samuel Chia states that its product uses a Short LC burst on the CACH for “scan time improvement.”

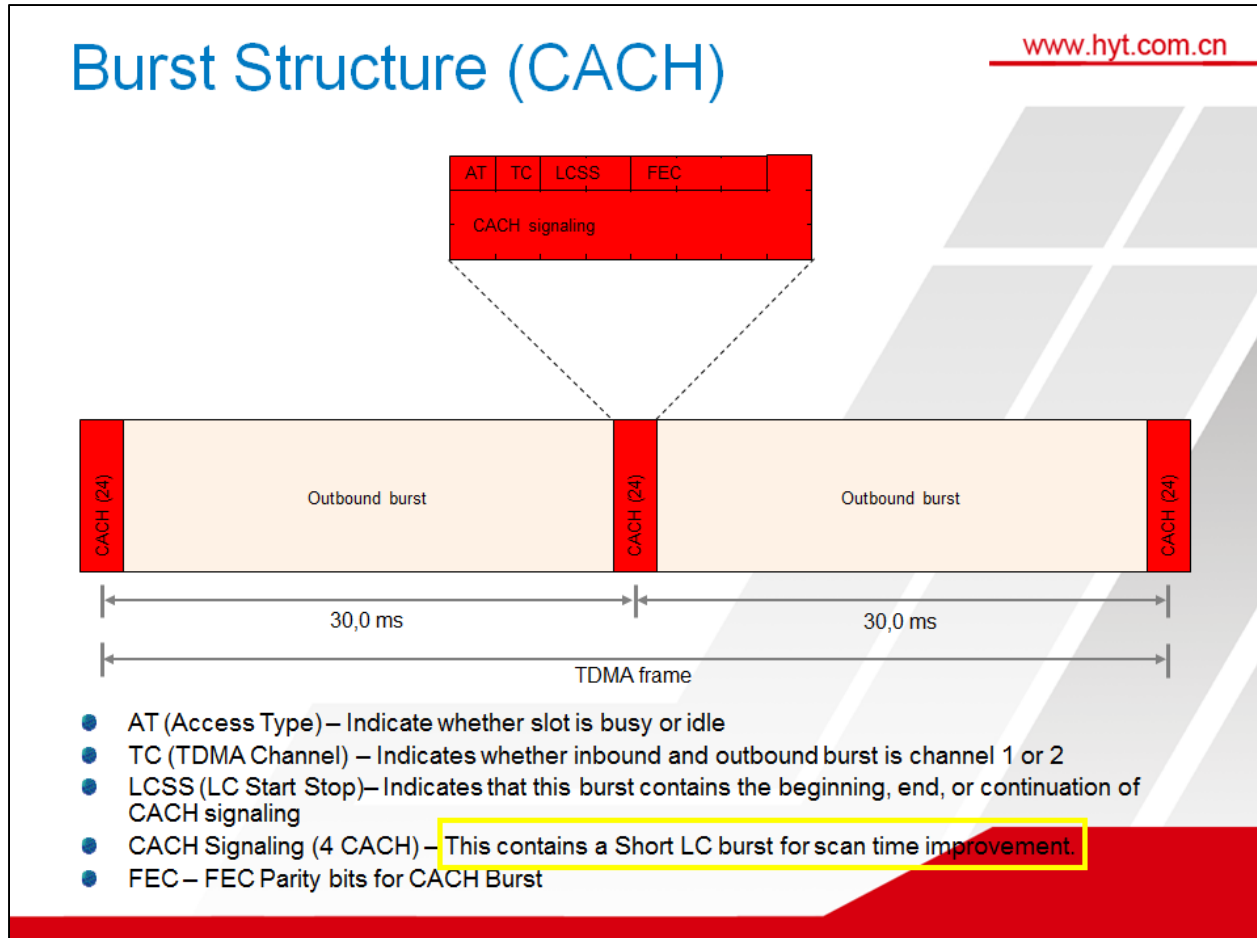

See Samuel Chia, *DMR Protocol Introduction* at Slide 32, (April 8, 2009), <https://www.slideserve.com/regina-clements/dmr-protocol-introduction>.

122. The accused products also include “a decoder for obtaining the at least one characteristic from the activity update message.” As previously alleged, the accused products receive an activity update message on the CACH. The accused products decode the message to obtain, for example, the destination address in the message, which may include a radio ID or a talkgroup ID.

123. The accused products also include “a comparator which compares the at least one characteristic with third preprogrammed information indicating at least one preprogrammed characteristic to determine whether the activity is of interest to the system.” For example, when an accused product receives an activity update message, it compares the received characteristic

to a preprogrammed information. For example, during scan, “[w]hen detecting some activities that you are interested in on a channel, the radio will pause on that channel until the Hang Time is up.” Hytera DMR System Planner at 36.

124. This functionality is shown, for example, by the operation of the accused products. For example, as shown below, Hytera radios B and C have scan enabled and are on digital Channel 2; Hytera radio A is on digital Channel 1. When radio A makes a call to radio C, radio C uses the activity update message to identify the call as activity of interest. Radio C then moves to digital Channel 1 to receive the call. Radio B, on the other hand, remains on digital Channel 2.

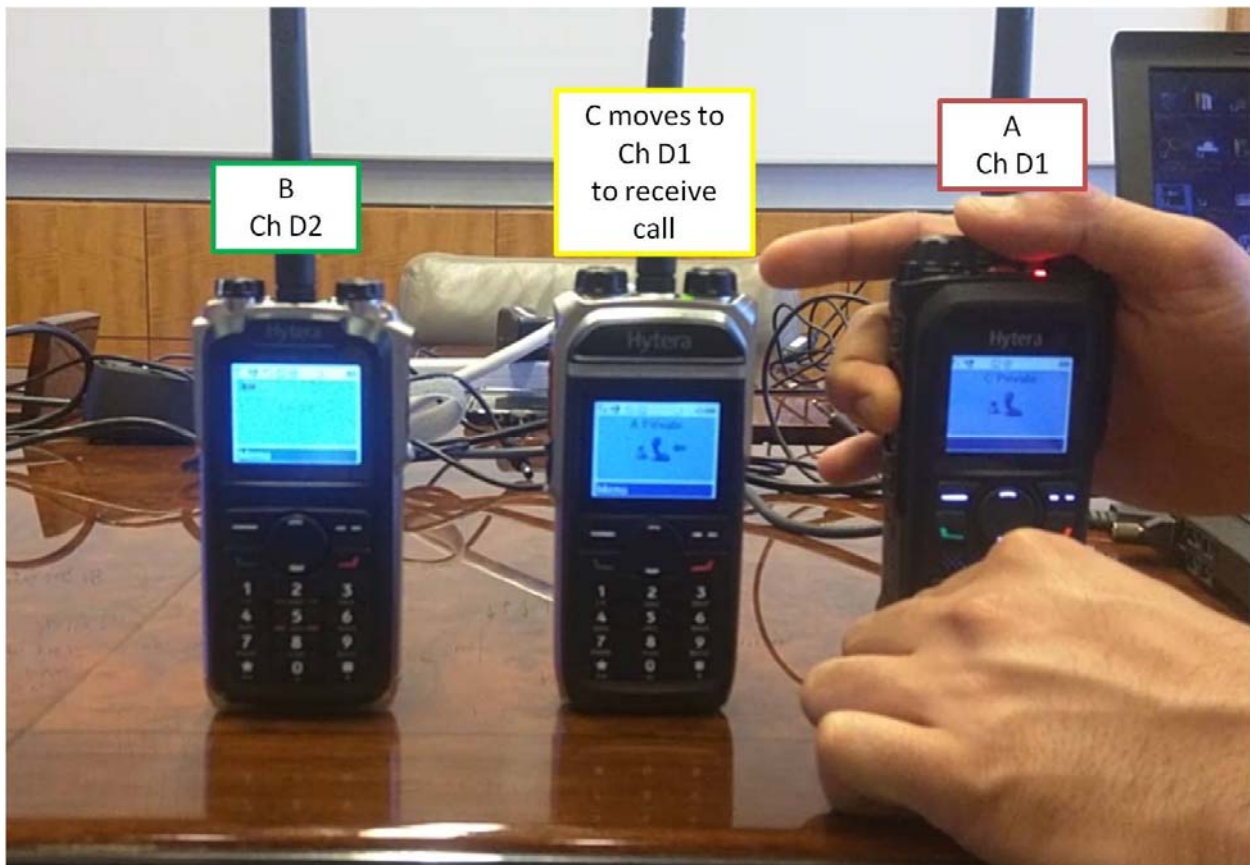

125. The accused products also include “a selector to receive activity which the comparator determines to be of interest.” As described above, for example, when the comparator

determines the activity to be of interest, the selector receives the activity on the corresponding channel. This functionality is also described in the Hytera DMR System Planner: “When detecting some activities that you are interested in on a channel, the radio will pause on that channel until the Hang Time is up.” Hytera DMR System Planner at 36.

126. In the accused products, “the operation of the receiver, the decoder, the comparator, and the selector are controlled by a processor.” For example, the accused products include a processor, such as a Texas Instruments OMAP5912 processor. The processor of the accused products controls the receiver, the decoder, the comparator, and the selector and automatically scans as described above.

127. The Hytera Defendants’ infringement has caused and is continuing to cause damage and irreparable injury to Motorola, and Motorola will continue to suffer damage and irreparable injury unless and until that infringement is enjoined by this Court.

128. It is worth noting that ALJ McNamara adopted Motorola’s proposed claim interpretation of the ’869 Patent in Inv. No. 337-TA-1053.<sup>67</sup>

129. Motorola is entitled to injunctive relief and damages in accordance with 35 U.S.C. §§ 271, 281, 283, and 284.

130. The Hytera Defendants have infringed the ’869 patent as alleged above, despite having prior knowledge of the patent and has acted with willful, intentional, and conscious disregard of the objectively high likelihood that their acts constitute infringement of the ’869 patent. Indeed, as previously alleged, the Hytera Defendants intentionally and knowingly misappropriated and copied proprietary innovations developed and patented by Motorola, including technology that the Hytera Defendants now market as their own scan technology. This

---

<sup>67</sup> Exhibit 17, *Certain Two-Way Radio Equipment and Systems, Related Software and Components Thereof*, Construing Certain Terms of the Asserted Claims of the Patents at Issue [Markman Claim Construction], Inv. No. 337-TA-1053, Chart 1 at 21-22.

conduct is egregious and constitutes willful infringement under 35 U.S.C. § 284, entitling Motorola to enhanced damages.

**COUNT IV — INFRINGEMENT OF THE '701 PATENT**

131. Motorola incorporates and re-alleges Paragraphs 1 through 130 of this Amended Complaint as if fully set forth herein.

132. The USPTO duly and legally issued the '701 Patent on June 1, 2010.

133. Hytera Corporation has infringed one or more claims of the '701 Patent, including at least claim 13, either literally or under the doctrine of equivalents, by importing into the United States products that are covered by one or more claims of the '701 Patent. These products include, but are not limited to the RD662, RD962, RD982, RD982S, RD982AN, BD302, BD502, PD362, PD412, PD502, PD562, PD602/PD602G, PD662/PD662G, PD682/PD682G, PD702/PD702G, PD702G UL913, PD752/PD752G, PD782/PD782G, PD782 UL913, PD792 EX, PD982, X1e, X1p, MD652/MD652G, and MD782/MD782 products, that are covered by one or more claims of the '701 Patent, including products implementing repeater access functionality.

134. Hytera Corporation has had knowledge of the '701 Patent since its issuance in 2010. The application for the '701 Patent was filed before at least Samuel Chia, G.S. Kok, and Y.T. Kok left Motorola, and documentation regarding the '701 Patent was downloaded by one or more of the former Motorola employees before departing. Samuel Chia became a Software Engineering Director at Hytera Corporation working on the accused products. Samuel Chia's responsibilities at Hytera Corporation also encompassed reviewing and understanding the intellectual property related to commercial radio technology; in fact, Samuel Chia has discussed and identified a specific Motorola patent in a publicly available presentation made on behalf of

Hytera Corporation.<sup>68</sup> Since 2008, Hytera Corporation's employees, including at least the former Motorola employees, have also reviewed and monitored the issuance of Motorola patents related to commercial radio technology, including the '701 Patent. Hytera Corporation also has had knowledge of the '701 Patent at least as the result of the filing of the original Complaint in this action.

135. In addition to directly infringing the '701 Patent, Hytera Corporation has indirectly infringed one or more claims of the '701 Patent, including at least claim 13, by actively inducing others to directly infringe the '701 Patent in violation of 35 U.S.C. § 271(b). Specifically, and in light of the knowledge of the '701 Patent by Hytera Corporation, Hytera Corporation knowingly induced infringement of the '701 Patent with specific intent to do so by its activities relating to the importation of its products to its purchasers, including but not limited to the RD662, RD962, RD982, RD982S, RD982AN, BD302, BD502, PD362, PD412, PD502, PD562, PD602/PD602G, PD662/PD662G, PD682/PD682G, PD702/PD702G, PD702G UL913, PD752/PD752G, PD782/PD782G, PD782 UL913, PD792 EX, PD982, X1e, X1p, MD652/MD652G, and MD782/MD782 products, and by instructing and encouraging purchasers (including through product documentation) to operate and use those products in an infringing manner with knowledge that these actions would infringe the '701 Patent. Indeed, ALJ McNamara determined that “[r]ecord evidence provided in this Investigation demonstrates that Hytera [Corporation] actively encourages, directs, intends, and teaches third parties to infringe the '701 patent, including by providing instructions on de-keying and re-keying, receiving

---

<sup>68</sup> See Samuel Chia, *DMR Protocol Introduction*, (April 8, 2009), <https://www.slideserve.com/regina-clements/dmr-protocol-introduction>.

customer complaints about de-keying/re-keying, and expecting customers to re-key and de-key the '701 Accused Products.”<sup>69</sup>

136. Hytera Corporation has also contributed to infringement of the '701 Patent by others by importing into the United States products, including but not limited to the RD662, RD962, RD982, RD982S, RD982AN, BD302, BD502, PD362, PD412, PD502, PD562, PD602/PD602G, PD662/PD662G, PD682/PD682G, PD702/PD702G, PD702G UL913, PD752/PD752G, PD782/PD782G, PD782 UL913, PD792 EX, PD982, X1e, X1p, MD652/MD652G, and MD782/MD782 products, that constitute a material part of the '701 Patent claimed inventions, that are especially made and/or adapted for infringing the '701 Patent and are not staple articles of commerce suitable for substantial non-infringing use and that have been sold to purchasers who infringe the '701 Patent.<sup>70</sup> Specifically, and in light of the knowledge of the '701 Patent by Hytera Corporation as previously alleged, Hytera Corporation had knowledge that its products, including but not limited to the RD662, RD962, RD982, RD982S, RD982AN, BD302, BD502, PD362, PD412, PD502, PD562, PD602/PD602G, PD662/PD662G, PD682/PD682G, PD702/PD702G, PD702G UL913, PD752/PD752G, PD782/PD782G, PD782 UL913, PD792 EX, PD982, X1e, X1p, MD652/MD652G, and MD782/MD782 products, were specifically made and/or adapted for infringement of the '701 Patent and are not staple articles of commerce suitable for substantial noninfringing use.

137. Hytera America West has infringed one or more claims of the '701 Patent, including at least claim 13, either literally or under the doctrine of equivalents, by making, using, selling, and/or offering for sale within the United States and/or importing into the United States

---

<sup>69</sup> Exhibit 12, *Certain Two-Way Radio Equipment and Systems, Related Software and Components Thereof*, Initial Determination on Violation of Section 337 and Recommended Determination on Remedy and Bond (Public Version), Inv. No. 337-TA-1053 at 231.

<sup>70</sup> *Id.*

products that are covered by one or more claims of the '701 Patent. These products include, but are not limited to the RD662, RD962, RD982, RD982S, RD982AN, BD302, BD502, PD362, PD412, PD502, PD562, PD602/PD602G, PD662/PD662G, PD682/PD682G, PD702/PD702G, PD702G UL913, PD752/PD752G, PD782/PD782G, PD782 UL913, PD792 EX, PD982, X1e, X1p, MD652/MD652G, and MD782/MD782 products, that are covered by one or more claims of the '701 Patent, including products implementing repeater access functionality.

138. Hytera America West has had knowledge of the '701 Patent since Hytera Corporation established Hytera America West in March 2016. Employees of Hytera Corporation, who established Hytera America West in March 2016, have also reviewed and monitored the issuance of Motorola patents related to commercial radio technology, including the '701 Patent. Hytera America West also has had knowledge of the '701 Patent at least as the result of the filing of the original Complaint in this action.

139. In addition to directly infringing the '701 Patent, Hytera America West has indirectly infringed one or more claims of the '701 Patent, including at least claim 13, by actively inducing others to directly infringe the '701 Patent in violation of 35 U.S.C. § 271(b). Specifically, and in light of the knowledge of the '701 Patent by Hytera America West, Hytera America West knowingly induced infringement of the '701 Patent with specific intent to do so by its activities relating to the marketing, distribution, and/or sale of its products to its purchasers, including but not limited to the RD662, RD962, RD982, RD982S, RD982AN, BD302, BD502, PD362, PD412, PD502, PD562, PD602/PD602G, PD662/PD662G, PD682/PD682G, PD702/PD702G, PD702G UL913, PD752/PD752G, PD782/PD782G, PD782 UL913, PD792 EX, PD982, X1e, X1p, MD652/MD652G, and MD782/MD782 products, and by instructing and encouraging purchasers (including through product documentation) to operate



and use those products in an infringing manner with knowledge that these actions would infringe the '701 Patent. Indeed, ALJ McNamara determined that “[r]ecord evidence provided in this Investigation demonstrates that Hytera [America West] actively encourages, directs, intends, and teaches third parties to infringe the '701 patent, including by providing instructions on de-keying and re-keying, receiving customer complaints about de-keying/re-keying, and expecting customers to re-key and de-key the '701 Accused Products.”<sup>71</sup>

140. Hytera America West has contributed to infringement of the '701 Patent by others by selling and/or offering for sale to Hytera America West's purchasers within the United States and/or importing into the United States products, including but not limited to the RD662, RD962, RD982, RD982S, RD982AN, BD302, BD502, PD362, PD412, PD502, PD562, PD602/PD602G, PD662/PD662G, PD682/PD682G, PD702/PD702G, PD702G UL913, PD752/PD752G, PD782/PD782G, PD782 UL913, PD792 EX, PD982, X1e, X1p, MD652/MD652G, and MD782/MD782 products, that constitute a material part of the '701 Patent claimed inventions, that are especially made and/or adapted for infringing the '701 Patent and are not staple articles of commerce suitable for substantial non-infringing use and that have been sold to purchasers who infringe the '701 Patent.<sup>72</sup> Specifically, and in light of the knowledge of the '701 Patent by Hytera as previously alleged, Hytera America West had knowledge that its products, including but not limited to the RD662, RD962, RD982, RD982S, RD982AN, BD302, BD502, PD362, PD412, PD502, PD562, PD602/PD602G, PD662/PD662G, PD682/PD682G, PD702/PD702G, PD702G UL913, PD752/PD752G, PD782/PD782G, PD782 UL913, PD792 EX, PD982, X1e, X1p, MD652/MD652G, and MD782/MD782 products, were

---

<sup>71</sup> *Id.*

<sup>72</sup> *Id.*

specifically made and/or adapted for infringement of the '701 Patent and are not staple articles of commerce suitable for substantial noninfringing use.

141. For example, the Hytera Defendants have infringed, and continues to infringe, at least claim 13 of the '701 Patent:

13. In a conventional TDMA communications system, wherein the conventional TDMA communications system comprises at least one base station and at least one mobile station, a method of accessing a de-keyed base station comprising:

at a base station in the conventional TDMA communications system:

entering a temporary de-keyed state;

remaining in the temporary de-keyed state for a period of time;

receiving a transmission from a mobile station while in the temporary de-keyed state; and

entering a repeat state, if the transmission is received with proper synchronization while in the temporary de-keyed state .

142. The accused products implement a “method of accessing a de-keyed base station” “[i]n a conventional TDMA communications system, wherein the conventional TDMA communications system comprises at least one base station and at least one mobile station.” The method is also implemented “at a base station in the conventional TDMA communications system.” For example, the accused products operate in conventional mode in a TDMA system with two time slots. The accused repeaters are base stations, and they communicate with at least one mobile station, as shown in the illustration below:



Figure 2-1 Repeater Mode

See Hytera DMR System Planner at 127.

143. The accused products also de-key, for example, upon expiration of a timer, such as the Time-out Timer or the Subscriber Inactivity Timer. In an exemplary operation, after de-keying, an accused repeater allows an accused mobile station to access it via a wake up procedure. “In the repeater mode, if the radio needs to transmit through the repeater, it should wake up the repeater. Then this active repeater receives and retransmits the signal from any slot.” *Id.*

144. In addition, the accused products “enter[] a temporary de-keyed state.” For example, in the accused repeaters, after the Subscriber Inactivity Timer expires, “the repeater will enter IDLE status and wait for the next activation.” See Hytera DMR System Planner at 116. As another example, the Repeater TOT “is used to prevent the user from occupying the repeater for an extended time.” See Hytera’s DMR Conventional Series Release Notes at 16 (Aug. 15, 2013). This de-keyed state is temporary, as demonstrated, for example, by operation of a representative accused repeater, such as the RD982.

145. For example, when the RD982 initially repeats a call from a subscriber, the transmit, receive, and repeat indicators light up, as shown in the image below. Moreover, the transmission is shown by the signal peak at the transmit frequency on the left-hand side of the spectrum analyzer.

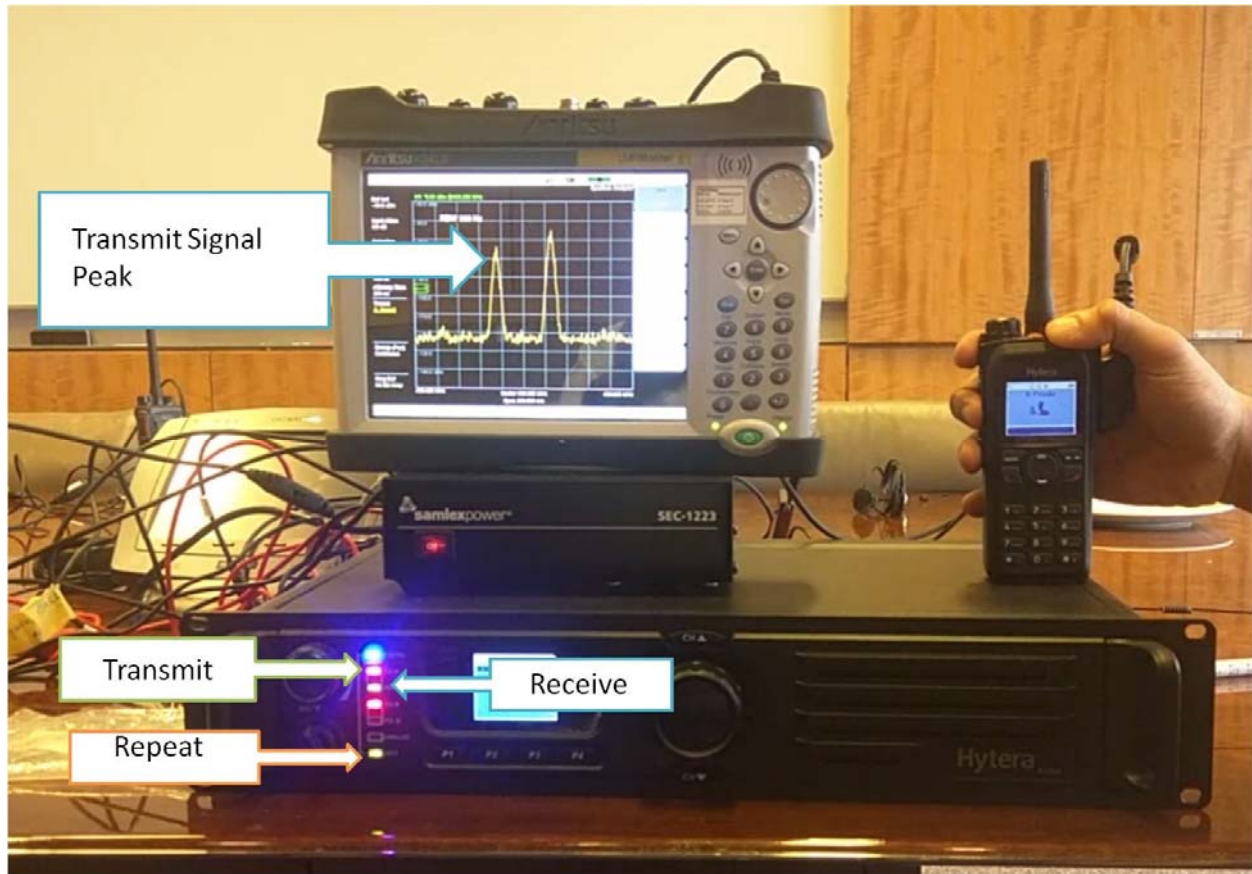

146. In an exemplary operation, upon expiration of a timer, the RD982 temporarily de-keys, as shown by the brief period during which the transmit indicators are turned off (first image below). The de-keying is subsequently detected by the spectrum analyzer, which registers a brief drop in signal peak at the transmit frequency (second image below).

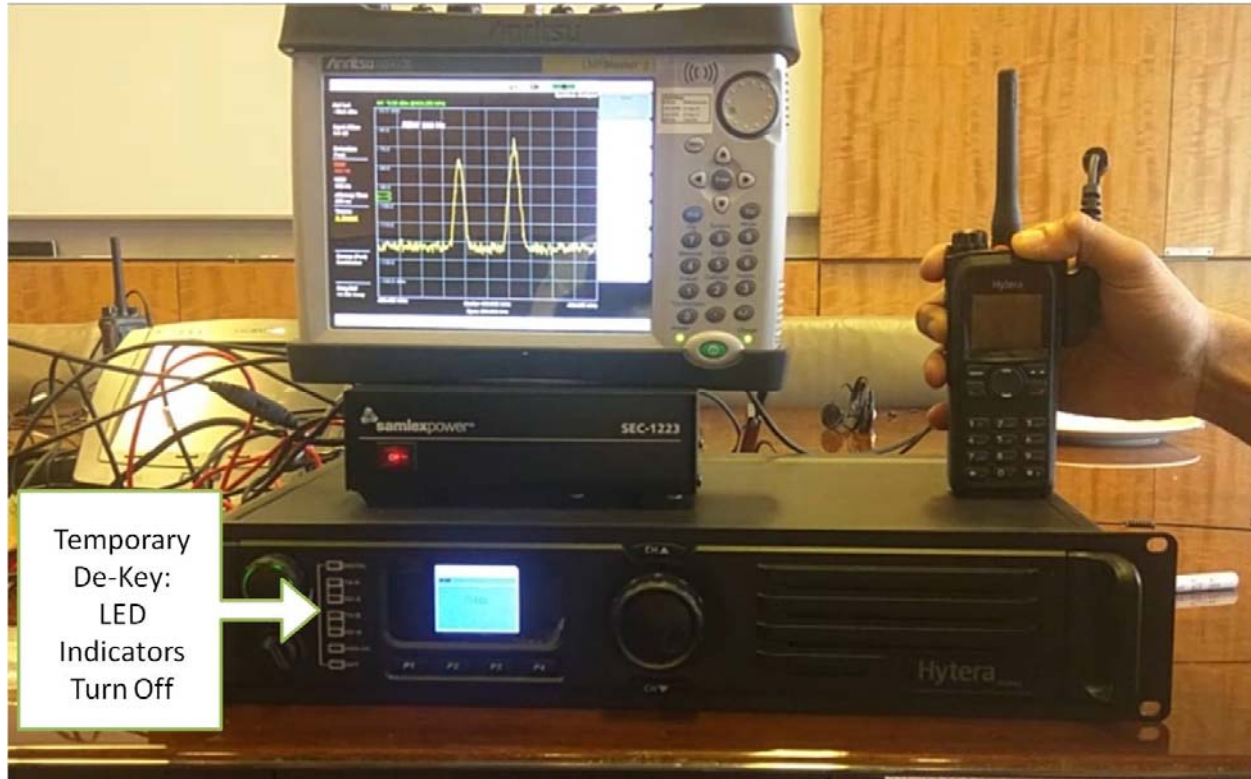

147. The accused products “remain[] in the temporary de-keyed state for a period of time.” In the exemplary operation described above, the accused mobile station continues a transmission during the temporary de-keyed state. As a result, for example, the representative RD982 immediately re-keys, as shown below by the reappearance of the transmit indicators, followed by reappearance of the signal peak at the transmit frequency.



148. The accused products also “receiv[e] a transmission from a mobile station while in the temporary de-keyed state” and “enter[] a repeat state, if the transmission is received with proper synchronization while in the temporary de-keyed state.” For example, as alleged above, if a transmission from the accused mobile station is received with proper synchronization in the temporary de-keyed state, it is immediately repeated by the representative RD982.

149. As explained in the below Hytera presentation prepared by Samuel Chia, for example, the transmissions from accused mobile stations to the accused repeaters include a

SYNC pattern at the center of a TDMA burst, which the accused repeaters use to determine if the transmission is received with proper synchronization.

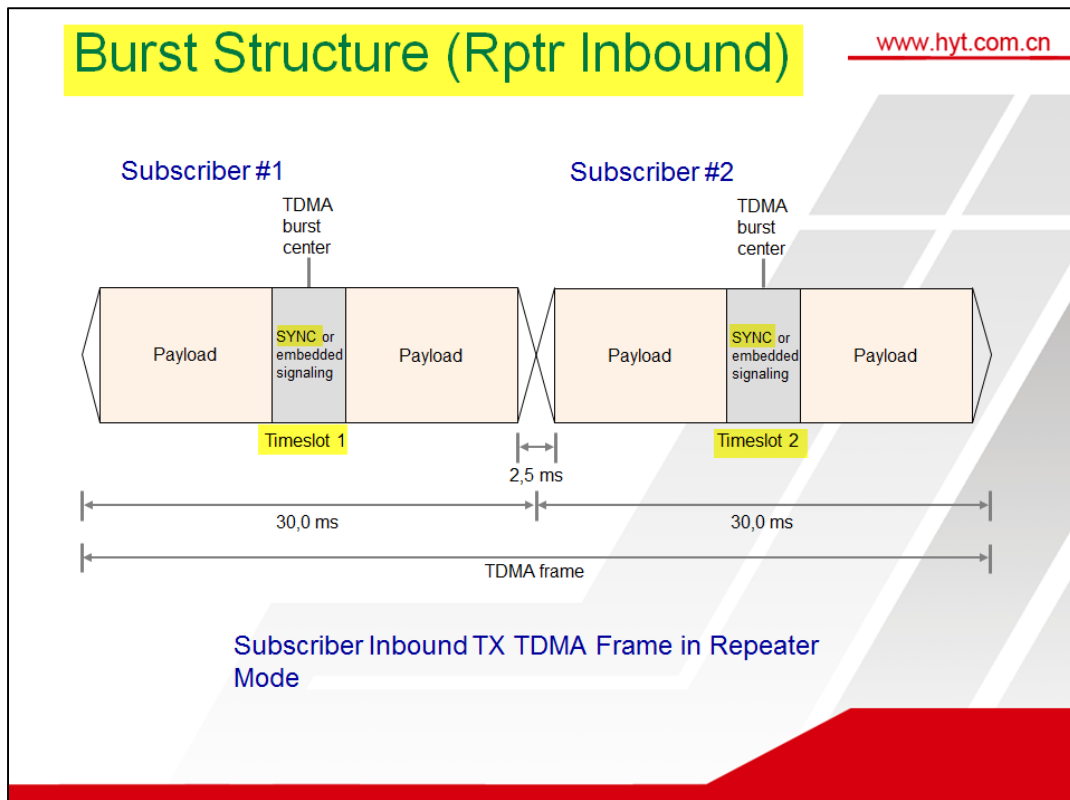

See Samuel Chia, *DMR Protocol Introduction* at Slide 25, (April 8, 2009), <https://www.slideserve.com/regina-clements/dmr-protocol-introduction>.

150. It is worth noting that ALJ McNamara adopted Motorola's proposed claim interpretation of the '701 Patent in Inv. No. 337-TA-1053.<sup>73</sup>

151. The Hytera Defendants' infringement has caused and is continuing to cause damage and irreparable injury to Motorola, and Motorola will continue to suffer damage and irreparable injury unless and until that infringement is enjoined by this Court.

152. Motorola is entitled to injunctive relief and damages in accordance with 35 U.S.C. §§ 271, 281, 283, and 284.

<sup>73</sup> Exhibit 17, *Certain Two-Way Radio Equipment and Systems, Related Software and Components Thereof*, Construing Certain Terms of the Asserted Claims of the Patents at Issue [Markman Claim Construction], Inv. No. 337-TA-1053, Chart 1 at 23-35.

153. The Hytera Defendants have infringed the '701 Patent as alleged above, despite having prior knowledge of the patent and has acted with willful, intentional, and conscious disregard of the objectively high likelihood that their acts constitute infringement of the '701 Patent. Indeed, as previously alleged, the Hytera Defendants intentionally and knowingly misappropriated documents related to proprietary innovations developed and patented by Motorola, including technology that the Hytera Defendants now market as their own repeater access functionality. This conduct is egregious and constitutes willful infringement under 35 U.S.C. § 284, entitling Motorola to enhanced damages.

**COUNT V — INFRINGEMENT OF THE '991 PATENT**

154. Motorola incorporates and re-alleges Paragraphs 1 through 153 of this Amended Complaint as if fully set forth herein.

155. The USPTO duly and legally issued the '991 Patent on October 2, 2012.

156. Hytera Corporation has infringed one or more claims of the '991 Patent, including at least claim 7, either literally or under the doctrine of equivalents, by importing into the United States products that are covered by one or more claims of the '991 Patent. These products include, but are not limited to, the PD502, PD562, PD602/PD602G, PD662/PD662G, PD682/PD682G, PD702/PD702G, PD702G UL913, PD752/PD752G, PD782/PD782G, PD782 UL913, PD792 EX, PD982, X1e, X1p, MD652/MD652G, and MD782/MD782 products, including products implementing “Pseudo-trunking” and “TDMA Direct Mode” functionality.

157. Hytera Corporation has had knowledge of the '991 Patent since its issuance in 2012. For example, the application leading to the '991 Patent was cited during prosecution of a Hytera Corporation patent in the United States. Samuel Chia's responsibilities at Hytera Corporation also encompassed reviewing and understanding the intellectual property related to



commercial radio technology; in fact, Samuel Chia has discussed and identified a specific Motorola patent in a publicly available presentation made on behalf of Hytera Corporation.<sup>74</sup> Since 2008, Hytera Corporation's employees, including at least the former Motorola employees, have also reviewed and monitored the issuance of Motorola patents related to commercial radio technology, including the '991 Patent. Hytera Corporation also has had knowledge of the '991 Patent at least as the result of the filing of the original Complaint in this action.

158. In addition to directly infringing the '991 Patent, Hytera Corporation has indirectly infringed one or more claims of the '991 Patent, including at least claim 7, by actively inducing others to directly infringe the '991 Patent in violation of 35 U.S.C. § 271(b). Specifically, and in light of the knowledge of the '991 Patent by Hytera Corporation, Hytera Corporation has knowingly inducing infringement of the '991 Patent with specific intent to do so by its activities relating to the importation of its radios to its purchasers, including but not limited to the PD502, PD562, PD602/PD602G, PD662/PD662G, PD682/PD682G, PD702/PD702G, PD702G UL913, PD752/PD752G, PD782/PD782G, PD782 UL913, PD792 EX, PD982, X1e, X1p, MD652/MD652G, and MD782/MD782 products, and by instructing and encouraging purchasers (including through product documentation) to operate and use those products in an infringing manner with knowledge that these actions would infringe the '991 Patent. Indeed, ALJ McNamara determined that “[r]ecord evidence demonstrates that Hytera [Corporation] actively encourages, directs, intends, and teaches third parties to infringe the '991 patent, including by providing training materials on how to configure Pseudo Trunk and TDMA Direct

---

<sup>74</sup> See generally Samuel Chia, *DMR Protocol Introduction*, (April 8, 2009), <https://www.slideserve.com/regina-clements/dmr-protocol-introduction>.

Mode.”<sup>75</sup> Training materials from Hytera Corporation explain how to configure Pseudo Trunk and TDMA Direct Mode.<sup>76</sup>

159. Hytera Corporation has contributed to infringement of the '991 Patent by others by importing into the United States radios, including but not limited to the PD502, PD562, PD602/PD602G, PD662/PD662G, PD682/PD682G, PD702/PD702G, PD702G UL913, PD752/PD752G, PD782/PD782G, PD782 UL913, PD792 EX, PD982, X1e, X1p, MD652/MD652G, and MD782/MD782 products, that constitute a material part of the '991 Patent claimed inventions, that are especially made and/or adapted for infringing the '991 Patent and are not staple articles of commerce suitable for substantial non-infringing use and that have been sold to purchasers who infringe the '991 Patent.<sup>77</sup> Specifically, and in light of the knowledge of the '991 Patent by Hytera Corporation as previously alleged, Hytera Corporation had knowledge that is products, including but not limited to the PD502, PD562, PD602/PD602G, PD662/PD662G, PD682/PD682G, PD702/PD702G, PD702G UL913, PD752/PD752G, PD782/PD782G, PD782 UL913, PD792 EX, PD982, X1e, X1p, MD652/MD652G, and MD782/MD782 products, were specifically made and/or adapted for infringement of the '991 Patent and are not staple articles of commerce suitable for substantial noninfringing use.

160. Hytera America West has infringed one or more claims of the '991 Patent, including at least claim 7, either literally or under the doctrine of equivalents, by making, using, selling, and/or offering for sale within the United States and/or importing into the United States products that are covered by one or more claims of the '991 Patent. These products include, but are not limited to, the Hytera PD502, PD562, PD602/PD602G, PD662/PD662G,

---

<sup>75</sup> Exhibit 12, *Certain Two-Way Radio Equipment and Systems, Related Software and Components Thereof*, Initial Determination on Violation of Section 337 and Recommended Determination on Remedy and Bond (Public Version), Inv. No. 337-TA-1053 at 232.

<sup>76</sup> *Id.*

<sup>77</sup> *Id.* at 232-33.

PD682/PD682G, PD702/PD702G, PD702G UL913, PD752/PD752G, PD782/PD782G, PD782 UL913, PD792 EX, PD982, X1e, X1p, MD652/MD652G, and MD782/MD782 products, including products implementing “Pseudo-trunking” and “TDMA Direct Mode” functionality.

161. Hytera America West has had knowledge of the '991 Patent since Hytera Corporation established Hytera America West in March 2016. Employees of Hytera Corporation, who established Hytera America West in March 2016, have also reviewed and monitored the issuance of Motorola patents related to commercial radio technology, including the '991 Patent. Hytera America West also has had knowledge of the '991 Patent at least as the result of the filing of the original Complaint in this action.

162. In addition to directly infringing the '991 Patent, Hytera America West has indirectly infringed one or more claims of the '991 Patent, including at least claim 7, by actively inducing others to directly infringe the '991 Patent in violation of 35 U.S.C. § 271(b). Specifically, and in light of the knowledge of the '991 Patent by Hytera America West, Hytera America West is knowingly inducing infringement of the '991 Patent with specific intent to do so by its activities relating to the marketing, distribution, and/or sale of its radios to its purchasers, including but not limited to the PD502, PD562, PD602/PD602G, PD662/PD662G, PD682/PD682G, PD702/PD702G, PD702G UL913, PD752/PD752G, PD782/PD782G, PD782 UL913, PD792 EX, PD982, X1e, X1p, MD652/MD652G, and MD782/MD782 products, and by instructing and encouraging purchasers (including through product documentation) to operate and use those products in an infringing manner with knowledge that these actions would infringe the '991 Patent. Indeed, ALJ McNamara determined that “[r]ecord evidence demonstrates that Hytera [America West] actively encourages, directs, intends, and teaches third parties to infringe the '991 patent, including by providing training materials on how to configure Pseudo Trunk and

TDMA Direct Mode.”<sup>78</sup> Training materials from Hytera America West explain how to configure Pseudo Trunk and TDMA Direct Mode.<sup>79</sup>

163. Hytera America West has also contributed to infringement of the '991 Patent by others by selling and/or offering for sale to Hytera America West's purchasers within the United States and/or importing into the United States radios, including but not limited to the PD502, PD562, PD602/PD602G, PD662/PD662G, PD682/PD682G, PD702/PD702G, PD702G UL913, PD752/PD752G, PD782/PD782G, PD782 UL913, PD792 EX, PD982, X1e, X1p, MD652/MD652G, and MD782/MD782 products, that constitute a material part of the '991 Patent claimed inventions, that are especially made and/or adapted for infringing the '991 Patent and are not staple articles of commerce suitable for substantial non-infringing use and that have been sold to purchasers who infringe the '991 Patent. Specifically, and in light of the knowledge of the '991 Patent by Hytera America West as previously alleged, Hytera America West had knowledge that its products, including but not limited to the PD502, PD562, PD602/PD602G, PD662/PD662G, PD682/PD682G, PD702/PD702G, PD702G UL913, PD752/PD752G, PD782/PD782G, PD782 UL913, PD792 EX, PD982, X1e, X1p, MD652/MD652G, and MD782/MD782 products, were specifically made and/or adapted for infringement of the '991 Patent and are not staple articles of commerce suitable for substantial noninfringing use.

164. For example, the Hytera Defendants have infringed, and continue to infringe, at least claim 7 of the '991 Patent:

7. In a time division multiple access (TDMA) system having a plurality of timeslots, a method comprises the steps of:

knowing a first set of synchronization patterns associated with a desired timeslot and a second set of synchronization patterns associated with each of the other timeslots in the TDMA system,

---

<sup>78</sup> *Id.*

<sup>79</sup> *Id.*

wherein the first set of synchronization patterns is mutually exclusive from the second set of synchronization patterns, and each set comprising at least two different synchronization patterns as a function of at least one of a payload type and a source of the transmission;

preparing to transmit a particular payload type in a timeslot;

determining whether the timeslot is a current desired timeslot for the TDMA system;

if the timeslot is the current desired timeslot, selecting a synchronization pattern selected from the first set of synchronization patterns based on the one of the particular payload type and a particular source of the transmission; otherwise selecting a synchronization pattern selected from the second set of synchronization patterns based on the one of the particular payload type and the particular source of the transmission; and

transmitting a burst in the timeslot having embedded the synchronization pattern that was selected.

165. The accused products operate in a “time division multiple access (TDMA) system having a plurality of timeslots.” For example, the accused products implement the Digital Mobile Radio (DMR) protocol, which is a TDMA protocol with two alternating timeslots. “The DMR technology divides one channel into two alternative slots, and thus allows twice the channels based on the same spectrum resource.” Hytera DMR System Planner at 8.

166. The accused products “know[] a first set of synchronization patterns associated with a desired timeslot and a second set of synchronization patterns associated with each of the other timeslots in the TDMA system, wherein the first set of synchronization patterns is mutually exclusive from the second set of synchronization patterns, and each set comprising at least two different synchronization patterns as a function of at least one of a payload type and a source of the transmission.” As one example, “[i]n Pseudo Trunk mode, the subscriber will take Slot 1 as its default Tx slot.” Hytera DMR System Planner at 57. The accused products know a first set of synchronization patterns associated with the desired timeslot and a second set associated with the other timeslot in the system, wherein the sets are mutually exclusive. For

example, the accused products can operate in TDMA direct mode. In TDMA direct mode, the accused products have different sets of synchronization patterns associated with different timeslots, as claimed.

167. The accused products also “prepar[e] to transmit a particular payload type in a timeslot” and “determin[e] whether the timeslot is a current desired timeslot for the TDMA system.” For example, the Hytera DMR System Planner explains that, “[b]efore transmitting, Subscriber A will detect the activities in the channel.” Hytera DMR System Planner at 56. As another example, in Pseudo-trunk mode, “[i]f the channel is free, [the radio] will transmit on Slot 1.” Hytera DMR System Planner at 56.

168. In the accused products, “if the timeslot is the current desired timeslot,” the accused products “select[] a synchronization pattern selected from the first set of synchronization patterns based on the one of the particular payload type and a particular source of the transmission; otherwise select[] a synchronization pattern selected from the second set of synchronization patterns based on the one of the particular payload type and the particular source of the transmission.” For example, for accused products operating in Pseudo-trunk mode, “[i]f the channel is free, it will transmit on Slot 1 and will set up the communication here with the receiver, Subscriber B. If Slot 1 is occupied, Subscriber A will transmit on Slot 2.” Hytera DMR System Planner at 56. In other words, if the accused products are in Pseudo-trunk mode, they “can have communication in any time slot on the channel.” *Id.* at 57. A synchronization pattern is selected based on payload type.

169. The accused products also “transmit[] a burst in the timeslot having embedded the synchronization pattern that was selected.” For example, the selected synchronization patterns are transmitted in the first burst of the transmission.

170. It is worth noting that ALJ McNamara adopted Motorola's proposed claim interpretation of the '991 Patent in Inv. No. 337-TA-1053.<sup>80</sup>

171. The Hytera Defendants' infringement has caused and is continuing to cause damage and irreparable injury to Motorola, and Motorola will continue to suffer damage and irreparable injury unless and until that infringement is enjoined by this Court.

172. Motorola is entitled to injunctive relief and damages in accordance with 35 U.S.C. §§ 271, 281, 283, and 284.

173. The Hytera Defendants have infringed the '991 Patent as alleged above, despite having prior knowledge of the patent and has acted with willful, intentional, and conscious disregard of the objectively high likelihood that their acts constitute infringement of the '991 Patent. Indeed, as previously alleged, Hytera Corporation intentionally and knowingly misappropriated and copied proprietary innovations developed and patented by Motorola, including technology that the Hytera Defendants now markets as their own "Pseudo-trunking" technology. This conduct is egregious and constitutes willful infringement under 35 U.S.C. § 284, entitling Motorola to enhanced damages.

#### **COUNT VI — INFRINGEMENT OF THE '972 PATENT**

174. Motorola incorporates and re-alleges Paragraphs 1 through 173 of this Amended Complaint as if fully set forth herein.

175. The USPTO duly and legally issued the '972 Patent on August 4, 2015.

176. Hytera Corporation has infringed, and continues to infringe, one or more claims of the '972 Patent, including at least claim 7, either literally or under the doctrine of equivalents, by importing into the United States products that are covered by one or more claims of the '972

---

<sup>80</sup> Exhibit 17, *Certain Two-Way Radio Equipment and Systems, Related Software and Components Thereof*, Construing Certain Terms of the Asserted Claims of the Patents at Issue [Markman Claim Construction], Inv. No. 337-TA-1053, Chart 1 at 36-41.

Patent. These products include, but are not limited to, the Hytera PD502, PD502i, PD562, PD562i, PD602/PD602G, PD602i, PD662/PD662G, PD662i, PD682/PD682G, PD682i, PD702/PD702G, PD702G UL913, PD702i, PD752/PD752G, PD752i, PD782/PD782G, PD782 UL913, PD782i, PD792 EX, PD792i, PD982, PD982i, X1e, X1ei, X1p, X1pi, MD652/MD652G, MD652i, MD782/MD782, and MD782i products, including products implementing Loudness and Quality Optimizer (LQO) functionality.

177. Hytera Corporation has had knowledge of the '972 Patent at least as the result of the filing of the original Complaint in this action. In addition to directly infringing the '972 Patent, Hytera Corporation has indirectly infringed and continues to indirectly infringe one or more claims of the '972 Patent, including at least claim 7, by actively inducing others to directly infringe the '972 Patent in violation of 35 U.S.C. § 271(b). Specifically, and in light of the knowledge of the '972 Patent by Hytera Corporation, Hytera Corporation knowingly induces infringement of the '972 Patent with specific intent to do so by its activities related to the importation of its radios to its purchasers, including but not limited to the Hytera PD502, PD502i, PD562, PD562i, PD602/PD602G, PD602i, PD662/PD662G, PD662i, PD682/PD682G, PD682i, PD702/PD702G, PD702G UL913, PD702i, PD752/PD752G, PD752i, PD782/PD782G, PD782 UL913, PD782i, PD792 EX, PD792i, PD982, PD982i, X1e, X1ei, X1p, X1pi, MD652/MD652G, MD652i, MD782/MD782, and MD782i products, and by instructing and encouraging purchasers (including through product documentation) to operate and use those products in an infringing manner with knowledge that these actions would infringe the '972 Patent.

178. Hytera Corporation is contributing to infringement of the '972 Patent by others by importing into the United States radios, including but not limited to the Hytera PD502, PD502i,



PD562, PD562i, PD602/PD602G, PD602i, PD662/PD662G, PD662i, PD682/PD682G, PD682i, PD702/PD702G, PD702G UL913, PD702i, PD752/PD752G, PD752i, PD782/PD782G, PD782 UL913, PD782i, PD792 EX, PD792i, PD982, PD982i, X1e, X1ei, X1p, X1pi, MD652/MD652G, MD652i, MD782/MD782, and MD782i products, that constitute a material part of the '972 Patent claimed inventions, that are especially made and/or adapted for infringing the '972 Patent and are not staple articles of commerce suitable for substantial non-infringing use and that have been sold to purchasers who infringe the '972 Patent. Specifically, and in light of the knowledge of the '972 Patent by Hytera Corporation as previously alleged, Hytera Corporation has knowledge that its products, including but not limited to the PD502, PD502i, PD562, PD562i, PD602/PD602G, PD602i, PD662/PD662G, PD662i, PD682/PD682G, PD682i, PD702/PD702G, PD702G UL913, PD702i, PD752/PD752G, PD752i, PD782/PD782G, PD782 UL913, PD782i, PD792 EX, PD792i, PD982, PD982i, X1e, X1ei, X1p, X1pi, MD652/MD652G, MD652i, MD782/MD782, and MD782i products, are specifically made and/or adapted for infringement of the '972 Patent and are not staple articles of commerce suitable for substantial noninfringing use.

179. Hytera America West has infringed, and continues to infringe, one or more claims of the '972 Patent, including at least claim 7, either literally or under the doctrine of equivalents, by making, using, selling, and/or offering for sale within the United States and/or importing into the United States products that are covered by one or more claims of the '972 Patent. These products include, but are not limited to, the Hytera PD502, PD502i, PD562, PD562i, PD602/PD602G, PD602i, PD662/PD662G, PD662i, PD682/PD682G, PD682i, PD702/PD702G, PD702G UL913, PD702i, PD752/PD752G, PD752i, PD782/PD782G, PD782 UL913, PD782i, PD792 EX, PD792i, PD982, PD982i, X1e, X1ei, X1p, X1pi, MD652/MD652G, MD652i,

MD782/MD782, and MD782i products, including products implementing Loudness and Quality Optimizer (LQO) functionality.

180. Hytera America West has had knowledge of the '972 Patent at least as the result of the filing of the original Complaint in this action. In addition to directly infringing the '972 Patent, Hytera America West has indirectly infringed and continues to indirectly infringe one or more claims of the '972 Patent, including at least claim 7, by actively inducing others to directly infringe the '972 Patent in violation of 35 U.S.C. § 271(b). Specifically, and in light of the knowledge of the '972 Patent by Hytera America West, Hytera America West knowingly induces infringement of the '972 Patent with specific intent to do so by its activities related to the marketing, distribution, and/or sale of its radios to its purchasers, including but not limited to the PD502, PD502i, PD562, PD562i, PD602/PD602G, PD602i, PD662/PD662G, PD662i, PD682/PD682G, PD682i, PD702/PD702G, PD702G UL913, PD702i, PD752/PD752G, PD752i, PD782/PD782G, PD782 UL913, PD782i, PD792 EX, PD792i, PD982, PD982i, X1e, X1ei, X1p, X1pi, MD652/MD652G, MD652i, MD782/MD782, and MD782i products, and by instructing and encouraging purchasers (including through product documentation) to operate and use those products in an infringing manner with knowledge that these actions would infringe the '972 Patent.

181. Hytera America West is contributing to infringement of the '972 Patent by others by selling and/or offering for sale to Hytera America West's purchasers within the United States and/or importing into the United States radios, including but not limited to the PD502, PD502i, PD562, PD562i, PD602/PD602G, PD602i, PD662/PD662G, PD662i, PD682/PD682G, PD682i, PD702/PD702G, PD702G UL913, PD702i, PD752/PD752G, PD752i, PD782/PD782G, PD782 UL913, PD782i, PD792 EX, PD792i, PD982, PD982i, X1e, X1ei, X1p, X1pi, MD652/MD652G,

MD652i, MD782/MD782, and MD782i products, that constitute a material part of the '972 Patent claimed inventions, that are especially made and/or adapted for infringing the '972 Patent and are not staple articles of commerce suitable for substantial non-infringing use and that have been sold to purchasers who infringe the '972 Patent. Specifically, and in light of the knowledge of the '972 Patent by Hytera America West as previously alleged, Hytera America West has knowledge that its products, including but not limited to the PD502, PD502i, PD562, PD562i, PD602/PD602G, PD602i, PD662/PD662G, PD662i, PD682/PD682G, PD682i, PD702/PD702G, PD702G UL913, PD702i, PD752/PD752G, PD752i, PD782/PD782G, PD782 UL913, PD782i, PD792 EX, PD792i, PD982, PD982i, X1e, X1ei, X1p, X1pi, MD652/MD652G, MD652i, MD782/MD782, and MD782i products, are specifically made and/or adapted for infringement of the '972 Patent and are not staple articles of commerce suitable for substantial noninfringing use.

182. For example, the Hytera Defendants have infringed, and continue to infringe, at least claim 7 of the '972 Patent:

7. A method for adaptively controlling volume in a half-duplex speech communication device comprising:

establishing a user specified volume for audio output from a half-duplex speech communication device having a transmit state, a receive state, and an idle state, wherein by default audio input circuitry of the half-duplex speech communication device is inactive in the receive state and idle state to conserve power of the half-duplex speech communication device;

while the half-duplex speech communication device is in the receive state or the idle state, intermittently turning on the audio input circuitry, sampling for ambient noise, and turning the audio input circuitry off immediately after the sampling to conserve power;

determining a total adjustment for adaptive audio control of the half-duplex speech communication device based on the user specified volume, the ambient noise received from the sampling, and from an established signal to noise threshold for audio output from the half-duplex speech communication device; and

applying the total adjustment to received communications before audibly outputting the received communications from the half-duplex speech communication device.

183. The accused products practice “a method for adaptively controlling volume in a half-duplex speech communication device.” For example, the accused products implement the Hytera Loudness and Quality Optimizer (LQO), which “automatically adjust[s] the volume according to the environments.” *See* Hytera DMR Terminal Comparison Chart. The Hytera Customer Programming Software describes that “when in a noisy place,” LQO “will raise the volume and enhance the high frequency sound effect accordingly.” The accused products are also half-duplex speech communication devices that, for example, initiate transmissions using the Push to Talk (PTT) Button. Operation of the accused products, for example, also demonstrates that they are half-duplex speech communication devices.

184. The accused products “establish[] a user specified volume for audio output from a half-duplex speech communication device having a transmit state, a receive state, and an idle state.” For example, “[a]fter a Private Call is received, you may hold down the PTT key within the preset time period to call back.” Hytera DMR System Planner at 92. Operation of the accused products, for example, demonstrates that the accused products are in an idle state when they are neither transmitting nor receiving. The accused products also have a volume knob for establishing a user specified volume for audio output, as shown below:

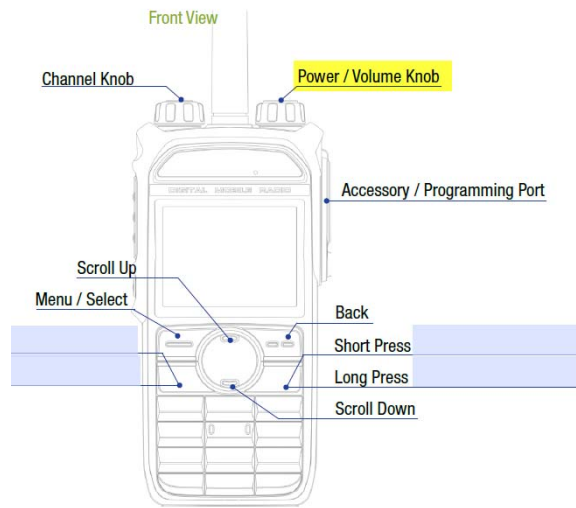

See PD682 User Guide – Quick Reference.

185. In the accused products, “by default audio input circuitry of the half-duplex speech communication device is inactive in the receive state and idle state to conserve power of the half-duplex speech communication device.” For example, the Hytera Customer Programming Software defines a parameter that “determines whether to enable the LQO feature when the radio is power on.” By “Default,” audio input circuitry is inactive. Rendering circuitry, such as audio input circuitry, inactive will conserve power.

186. In the accused products, “while the half-duplex speech communication device is in the receive state or the idle state, intermittently turning on the audio input circuitry, sampling for ambient noise, and turning the audio input circuitry off immediately after the sampling to conserve power.” For example, operation of the accused products demonstrates that ambient noise is sampled in the idle state:

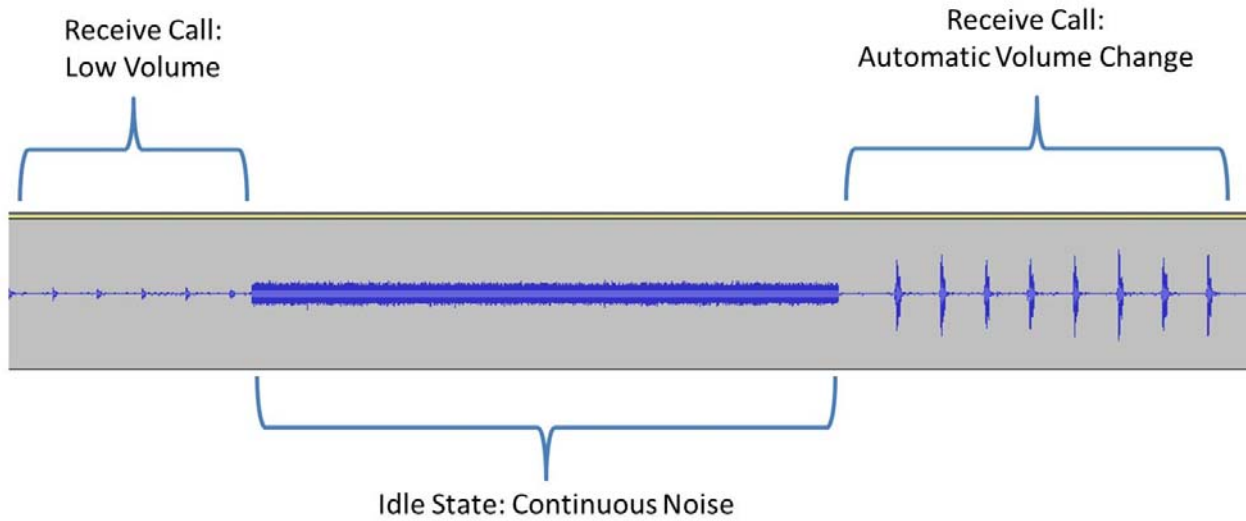

187. Operation of the accused products also shows that the audio input circuitry is intermittently turned on to sample the noise and then immediately turned off. For example, when a representative accused product was exposed to periodic noise with a period of 0.05s while in idle state, the representative accused product did not exhibit any perceptible volume change upon receiving a call, as shown below:

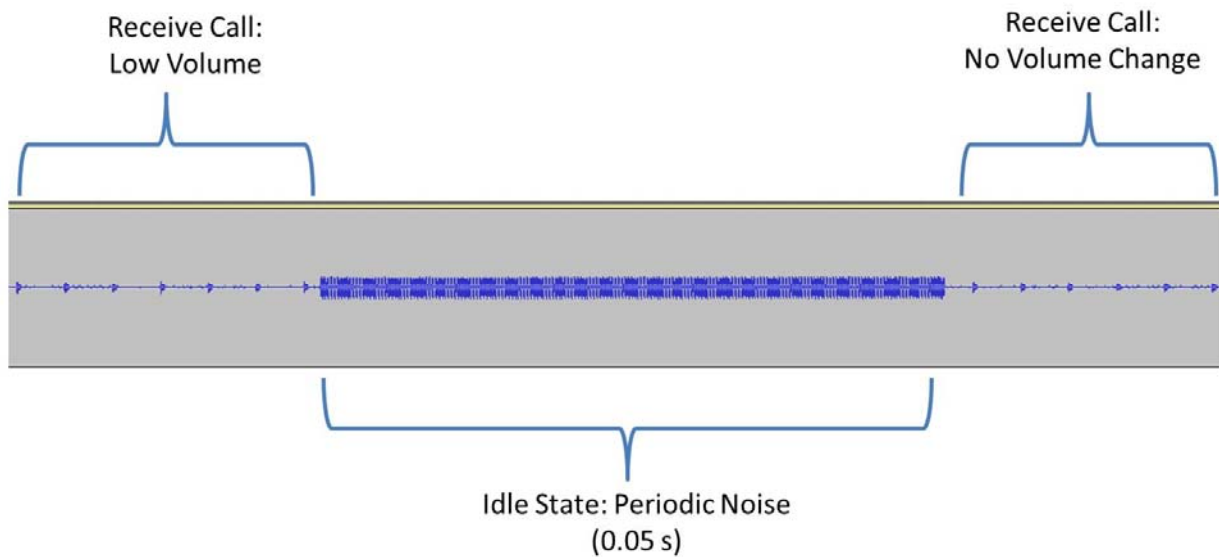

188. As another example, when the periodicity of the noise was adjusted to 0.04 seconds, the representative accused product sometimes exhibited a volume adjustment, but

sometimes did not. Thus, the accused products intermittently turn on the audio input circuitry, sample for ambient noise, and turn off the audio input immediately after sampling to conserve power.

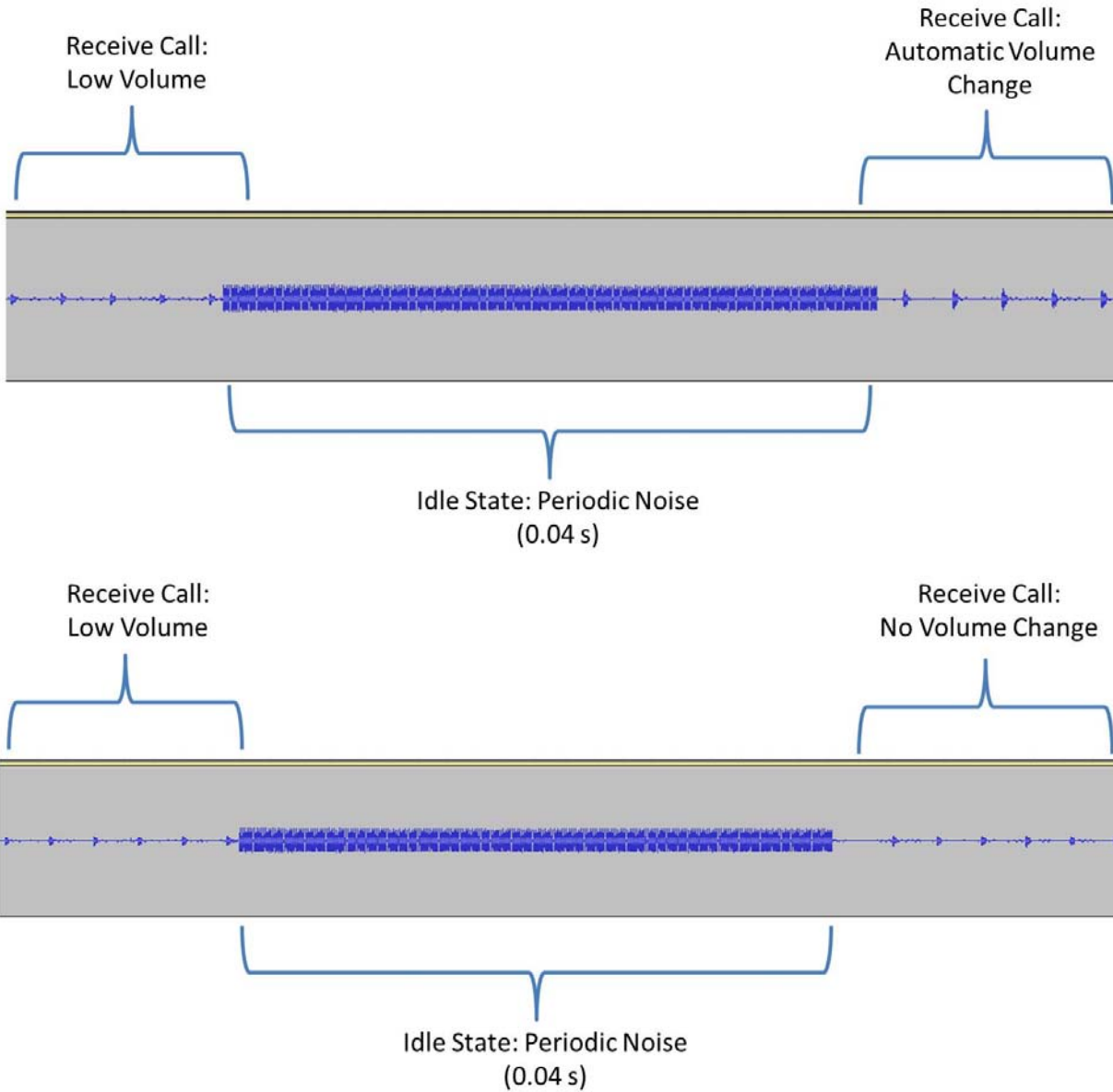

189. The accused products also “determin[e] a total adjustment for adaptive audio control of the half-duplex speech communication device based on the user specified volume, the ambient noise received from the sampling, and from an established signal to noise threshold for audio output from the half-duplex speech communication device.” For example, operation of the

accused products demonstrates that the total adjustment is based on ambient noise received from the sampling, as shown below:

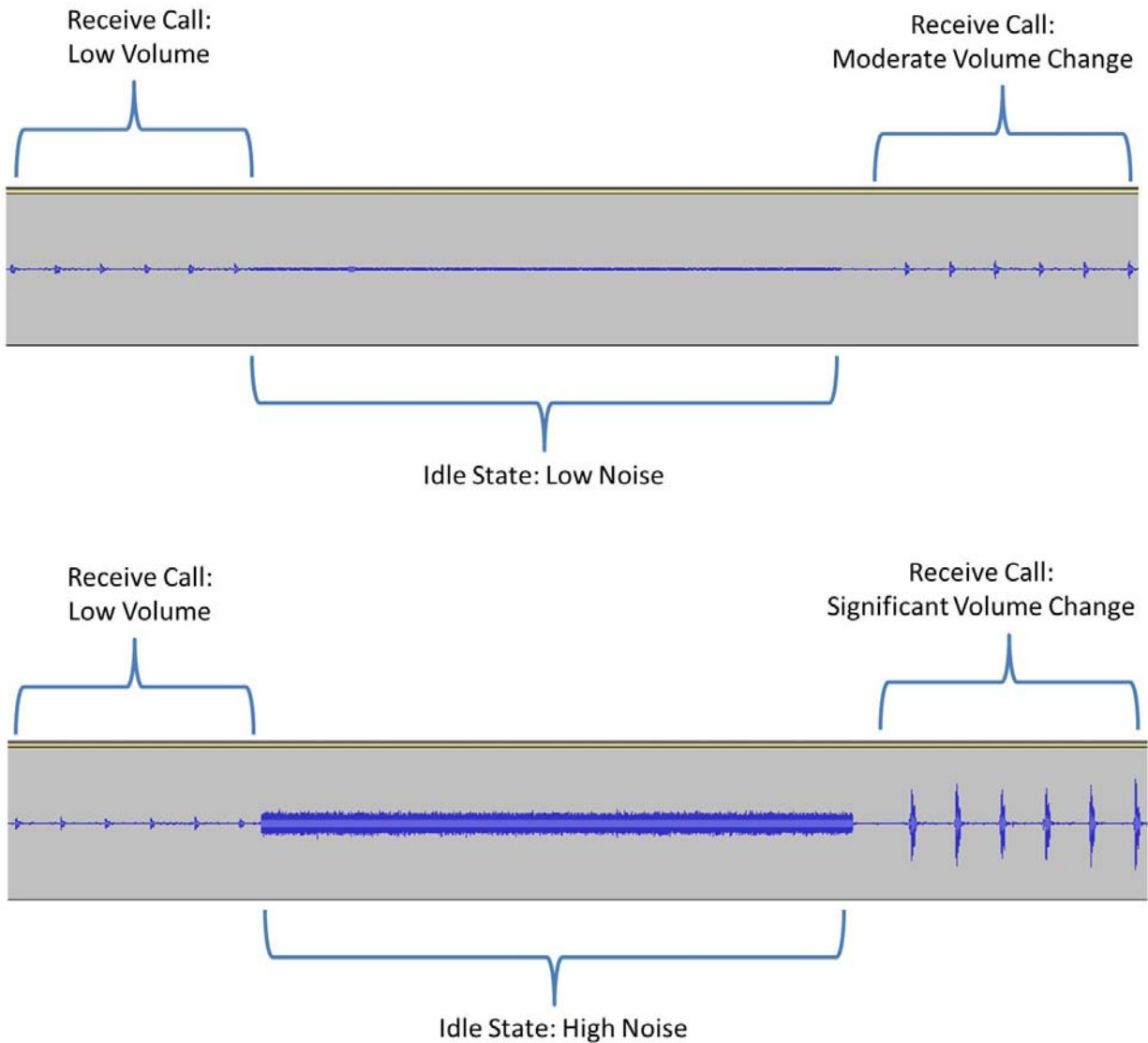

190. In addition, the total adjustment is based on the user specified volume and an established signal to noise threshold. For example, the Customer Programming Software for the accused radios allows a user to specify a “maximum volume that radio can reach when LQO feature is enabled.”



191. As another example, if the volume of the accused products is set to a medium setting, and the accused products are exposed to ambient noise, no resulting adjustment is detected.

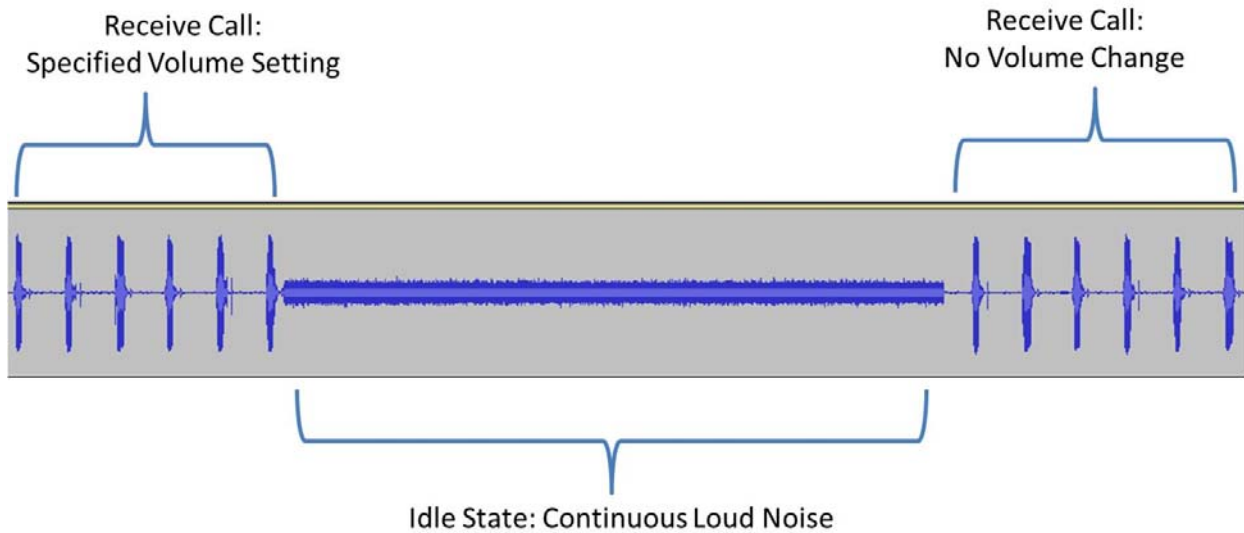

192. The accused products also “apply[] the total adjustment to received communications before audibly outputting the received communications from the half-duplex speech communication device.” As shown above, the determined total adjustment is applied to the received call before outputting the call.

193. It is worth noting that ALJ McNamara adopted Motorola’s proposed claim interpretation of the ’972 Patent in Inv. No. 337-TA-1053.<sup>81</sup>

194. The Hytera Defendants’ infringement has caused and is continuing to cause damage and irreparable injury to Motorola, and Motorola will continue to suffer damage and irreparable injury unless and until that infringement is enjoined by this Court.

<sup>81</sup> Exhibit 17, *Certain Two-Way Radio Equipment and Systems, Related Software and Components Thereof*, Construing Certain Terms of the Asserted Claims of the Patents at Issue [Markman Claim Construction], Inv. No. 337-TA-1053, Chart 1 at 42-52.

195. Motorola is entitled to injunctive relief and damages in accordance with 35 U.S.C. §§ 271, 281, 283, and 284.

**COUNT VII — INFRINGEMENT OF THE '111 PATENT**

196. Motorola incorporates and re-alleges Paragraphs 1 through 195 of this Amended Complaint as if fully set forth herein.

197. The USPTO duly and legally issued the '111 Patent on July 8, 2003.

198. Hytera Corporation has infringed, and continues to infringe, one or more claims of the '111 Patent, including at least claim 1, either literally or under the doctrine of equivalents, by importing into the United States products that are covered by one or more claims of the '111 Patent. These products include, but are not limited to, the BD302, BD302i, BD502, BD502i, BD552i, PD362, PD362i, PD402i, PD412, PD412i, PD502, PD502i, PD562, PD562i, PD602/PD602G, PD602i, PD662/PD662G, PD662i, PD682/PD682G, PD682i, PD702/PD702G, PD702G UL913, PD702i, PD752/PD752G, PD752i, PD782/PD782G, PD782 UL913, PD782i, PD792 EX, PD792i, PD982, PD982i, PDC760, X1e, X1ei, X1p, X1pi, MD612i, MD622i, MD652/MD652G, MD652i, MD782/MD782, MD782i, PDC760, RD662, RD662i, RD962, RD982, RD982i, RD982S, RD982Si, RD982AN, TC-3, TC-5, TC-6, TC-7, and/or TM-6 series products, including products implementing Hytera's Smart Dispatch and/or SmartOne functionality.

199. Hytera Corporation has had knowledge of the '111 Patent at least as the result of the filing of the original Complaint in this action. In addition to directly infringing the '111 Patent, Hytera Corporation has indirectly infringed and continues to indirectly infringe one or more claims of the '111 Patent, including at least claim 1, by actively inducing others to directly infringe the '111 Patent in violation of 35 U.S.C. § 271(b). Specifically, and in light of the

knowledge of the '111 Patent by Hytera Corporation, Hytera Corporation knowingly induced infringement of the '111 Patent with specific intent to do so by its activities relating to the importation of its products to its purchasers, including but not limited to the BD302, BD302i, BD502, BD502i, BD552i, PD362, PD362i, PD402i, PD412, PD412i, PD502, PD502i, PD562, PD562i, PD602/PD602G, PD602i, PD662/PD662G, PD662i, PD682/PD682G, PD682i, PD702/PD702G, PD702G UL913, PD702i, PD752/PD752G, PD752i, PD782/PD782G, PD782 UL913, PD782i, PD792 EX, PD792i, PD982, PD982i, PDC760, X1e, X1ei, X1p, X1pi, MD612i, MD622i, MD652/MD652G, MD652i, MD782/MD782, MD782i, PDC760, RD662, RD662i, RD962, RD982, RD982i, RD982S, RD982Si, RD982AN, TC-3, TC-5, TC-6, TC-7, and/or TM-6 series products, and by instructing and encouraging purchasers (including through product documentation) to operate and use those products in an infringing manner with knowledge that these actions would infringe the '111 Patent.

200. Hytera Corporation has also contributed to infringement of the '111 Patent by others by importing into the United States products, including but not limited to the BD302, BD302i, BD502, BD502i, BD552i, PD362, PD362i, PD402i, PD412, PD412i, PD502, PD502i, PD562, PD562i, PD602/PD602G, PD602i, PD662/PD662G, PD662i, PD682/PD682G, PD682i, PD702/PD702G, PD702G UL913, PD702i, PD752/PD752G, PD752i, PD782/PD782G, PD782 UL913, PD782i, PD792 EX, PD792i, PD982, PD982i, PDC760, X1e, X1ei, X1p, X1pi, MD612i, MD622i, MD652/MD652G, MD652i, MD782/MD782, MD782i, PDC760, RD662, RD662i, RD962, RD982, RD982i, RD982S, RD982Si, RD982AN, TC-3, TC-5, TC-6, TC-7, and/or TM-6 series products, that constitute a material part of the '111 Patent claimed inventions, that are especially made and/or adapted for infringing the '111 Patent and are not staple articles of commerce suitable for substantial non-infringing use and that have been sold to purchasers

who infringe the '111 Patent. Specifically, and in light of the knowledge of the '111 Patent by Hytera Corporation as previously alleged, Hytera Corporation had knowledge that its products, including but not limited to the BD302, BD302i, BD502, BD502i, BD552i, PD362, PD362i, PD402i, PD412, PD412i, PD502, PD502i, PD562, PD562i, PD602/PD602G, PD602i, PD662/PD662G, PD662i, PD682/PD682G, PD682i, PD702/PD702G, PD702G UL913, PD702i, PD752/PD752G, PD752i, PD782/PD782G, PD782 UL913, PD782i, PD792 EX, PD792i, PD982, PD982i, PDC760, X1e, X1ei, X1p, X1pi, MD612i, MD622i, MD652/MD652G, MD652i, MD782/MD782, MD782i, PDC760, RD662, RD662i, RD962, RD982, RD982i, RD982S, RD982Si, RD982AN, TC-3, TC-5, TC-6, TC-7, and/or TM-6 series products, were specifically made and/or adapted for infringement of the '111 Patent and are not staple articles of commerce suitable for substantial noninfringing use.

201. Hytera America West has infringed, and continues to infringe, one or more claims of the '111 Patent, including at least claim 1, either literally or under the doctrine of equivalents, by making, using, selling, and/or offering for sale within the United States and/or importing into the United States products that are covered by one or more claims of the '111 Patent. These products include, but are not limited to, the BD302, BD302i, BD502, BD502i, BD552i, PD362, PD362i, PD402i, PD412, PD412i, PD502, PD502i, PD562, PD562i, PD602/PD602G, PD602i, PD662/PD662G, PD662i, PD682/PD682G, PD682i, PD702/PD702G, PD702G UL913, PD702i, PD752/PD752G, PD752i, PD782/PD782G, PD782 UL913, PD782i, PD792 EX, PD792i, PD982, PD982i, PDC760, X1e, X1ei, X1p, X1pi, MD612i, MD622i, MD652/MD652G, MD652i, MD782/MD782, MD782i, PDC760, RD662, RD662i, RD962, RD982, RD982i, RD982S, RD982Si, RD982AN, TC-3, TC-5, TC-6, TC-7, and/or TM-6 series products, including products implementing Hytera's Smart Dispatch and/or SmartOne functionality.

202. Hytera America West has had knowledge of the '111 Patent at least as the result of the filing of the original Complaint in this action. In addition to directly infringing the '111 Patent, Hytera America West has indirectly infringed and continues to indirectly infringe one or more claims of the '111 Patent, including at least claim 1, by actively inducing others to directly infringe the '111 Patent in violation of 35 U.S.C. § 271(b). Specifically, and in light of the knowledge of the '111 Patent by Hytera America West, Hytera America West knowingly induced infringement of the '111 Patent with specific intent to do so by its activities relating to the marketing, distribution, and/or sale of its products to its purchasers, including but not limited to the BD302, BD302i, BD502, BD502i, BD552i, PD362, PD362i, PD402i, PD412, PD412i, PD502, PD502i, PD562, PD562i, PD602/PD602G, PD602i, PD662/PD662G, PD662i, PD682/PD682G, PD682i, PD702/PD702G, PD702G UL913, PD702i, PD752/PD752G, PD752i, PD782/PD782G, PD782 UL913, PD782i, PD792 EX, PD792i, PD982, PD982i, PDC760, X1e, X1ei, X1p, X1pi, MD612i, MD622i, MD652/MD652G, MD652i, MD782/MD782, MD782i, PDC760, RD662, RD662i, RD962, RD982, RD982i, RD982S, RD982Si, RD982AN, TC-3, TC-5, TC-6, TC-7, and/or TM-6 series products, and by instructing and encouraging purchasers (including through product documentation) to operate and use those products in an infringing manner with knowledge that these actions would infringe the '111 Patent.

203. Hytera America West has contributed to infringement of the '111 Patent by others by selling and/or offering for sale to Hytera America West's purchasers within the United States and/or importing into the United States products, including but not limited to the BD302, BD302i, BD502, BD502i, BD552i, PD362, PD362i, PD402i, PD412, PD412i, PD502, PD502i, PD562, PD562i, PD602/PD602G, PD602i, PD662/PD662G, PD662i, PD682/PD682G, PD682i, PD702/PD702G, PD702G UL913, PD702i, PD752/PD752G, PD752i, PD782/PD782G, PD782

UL913, PD782i, PD792 EX, PD792i, PD982, PD982i, PDC760, X1e, X1ei, X1p, X1pi, MD612i, MD622i, MD652/MD652G, MD652i, MD782/MD782, MD782i, PDC760, RD662, RD662i, RD962, RD982, RD982i, RD982S, RD982Si, RD982AN, TC-3, TC-5, TC-6, TC-7, and/or TM-6 series products, that constitute a material part of the '111 Patent claimed inventions, that are especially made and/or adapted for infringing the '111 Patent and are not staple articles of commerce suitable for substantial non-infringing use and that have been sold to purchasers who infringe the '111 Patent. Specifically, and in light of the knowledge of the '111 Patent by Hytera America West as previously alleged, Hytera America West had knowledge that its products, including but not limited to the BD302, BD302i, BD502, BD502i, BD552i, PD362, PD362i, PD402i, PD412, PD412i, PD502, PD502i, PD562, PD562i, PD602/PD602G, PD602i, PD662/PD662G, PD662i, PD682/PD682G, PD682i, PD702/PD702G, PD702G UL913, PD702i, PD752/PD752G, PD752i, PD782/PD782G, PD782 UL913, PD782i, PD792 EX, PD792i, PD982, PD982i, PDC760, X1e, X1ei, X1p, X1pi, MD612i, MD622i, MD652/MD652G, MD652i, MD782/MD782, MD782i, PDC760, RD662, RD662i, RD962, RD982, RD982i, RD982S, RD982Si, RD982AN, TC-3, TC-5, TC-6, TC-7, and/or TM-6 series products, were specifically made and/or adapted for infringement of the '111 Patent and are not staple articles of commerce suitable for substantial noninfringing use.

204. For example, the Hytera Defendants have infringed, and continue to infringe, at least claim 1 of the '111 Patent:

1. A group radio communication system comprising:

a first radio sub-network configured to implement point-to-multipoint communication sessions within said first radio sub-network;

a second radio sub-network configured to implement point-to-multipoint communication sessions within said second radio sub-network; and

a group controller in data communication with said first radio sub-network and said second radio sub-network, said group controller being configured to manage a common point-to-multipoint communication session involving said first radio sub-network and said second radio sub-network;

a packet switched data communication network coupled between said first radio sub-network and said group controller and between said second radio sub-network and said group controller;

a radio sub-network controller associated with each of said first and second radio sub-networks and a plurality of subscriber radios in communication with said radio sub-network controller, and

each of said radio sub-network controllers is configured to resolve conflicts between substantially concurrent requests from said plurality of subscriber radios in communication with said radio sub-network controller to be origination points for a point-to-multipoint monolog and to provide subscriber traffic distribution to said plurality of subscriber radios in communication with said radio sub-network controller.

205. The accused products comprise group radio communication systems. For example, the Hytera Defendants state that the Hytera Smart Dispatch system “is designed for the efficient communication, management and dispatching of a radio fleet.” Hytera Smart Dispatch Brochure at 2.

206. The accused products comprise “a first radio sub-network configured to implement point to-multipoint communication sessions within said first radio sub-network” and “a second radio sub-network configured to implement point-to-multipoint communication sessions within said second radio sub-network.” For example, as shown in the Hytera Smart Dispatch Configuration Guide, the Hytera Smart Dispatch system comprises first and second radio sub-networks, each configured with a Hytera repeater that implements point-to-multipoint communication sessions between Hytera radios.

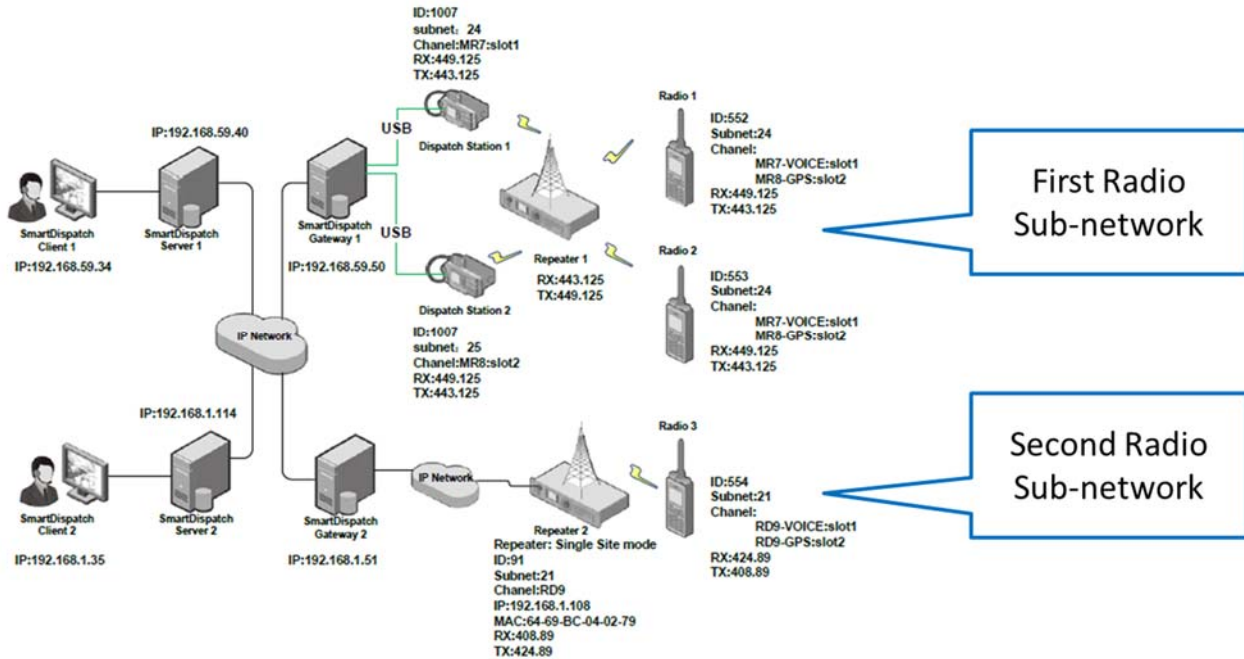

Hytera Smart Dispatch Configuration Guide at 6.

207. The accused products comprise “a group controller in data communication with said first radio sub-network and said second radio sub-network, said group controller being configured to manage a common point-to-multipoint communication session involving said first radio sub-network and said second radio sub-network.” For example, the Hytera Smart Dispatch system has a group controller, such as the Smart Dispatch client and/or server, in data communication with the first and second radio sub-networks. The Smart Dispatch group controller manages a common point-to-multipoint communication session. As an example, Hytera describes the Smart Dispatch group controller functionality as follows:

#### AudioLink

Allows users to patch talk groups, channels, sites and systems together so there is a seamless communication between all radio users. Once the communication link is established all radio operate together regardless of frequency or if they are operating in analog or digital mode. All these configurations can be easily configured through the Hytera Smart Dispatch System dispatcher console.



Hytera Smart Dispatch Brochure at 4.

208. The accused products comprise “a packet switched data communication network coupled between said first radio sub-network and said group controller and between said second radio sub-network and said group controller.” For example, in the Hytera Smart Dispatch system, the first and second radio sub-networks are connected to the group controller via an IP network. *See* Hytera Smart Dispatch Configuration Guide at 6.

209. The accused products also comprise “a radio sub-network controller associated with each of said first and second radio sub-networks and a plurality of subscriber radios in communication with said radio sub-network controller.” For example, the radio sub-network in the Hytera Smart Dispatch system includes a Hytera repeater and/or a Hytera dispatch station. *See* Hytera Smart Dispatch Configuration Guide at 6.

210. In the accused products, “each of said radio sub-network controllers is configured to resolve conflicts between substantially concurrent requests from said plurality of subscriber radios in communication with said radio sub-network controller to be origination points for a point-to-multipoint monolog and to provide subscriber traffic distribution to said plurality of subscriber radios in communication with said radio sub-network controller.” For example, the Hytera repeaters resolve conflicts between substantially concurrent requests and provide subscriber traffic distribution. As one example, the “Enhanced Channel Access” feature in the Hytera repeaters “is used to reduce call interference for users.” *See* DMR Conventional Series Release Notes (Aug. 15, 2013) at 12. “With this feature enabled, when there are multiple call requests on one channel, the repeater will only respond to one call request and reject others.” *Id.*

211. The Hytera Defendants' infringement has caused and is continuing to cause damage and irreparable injury to Motorola, and Motorola will continue to suffer damage and irreparable injury unless and until that infringement is enjoined by this Court.

212. Motorola is entitled to injunctive relief and damages in accordance with 35 U.S.C. §§ 271, 281, 283, and 284.

**PRAYER FOR RELIEF**

WHEREFORE, Motorola prays for relief as follows:

1. For a declaration that each of the Hytera Defendants has infringed the Patents-in-Suit;
2. For a declaration of a substantial likelihood that each of the Hytera Defendants will continue to infringe Motorola's intellectual property unless enjoined from doing so;
3. That, in accordance with 35 U.S.C. § 283, each of the Hytera Defendants, and all affiliates, employees, agents, officers, directors, attorneys, successors, and assigns, and all those acting on behalf of or in active concert or participation with any of them, be preliminarily and permanently enjoined from infringing the Patents-in-Suit;
4. For an award of damages sufficient to compensate Motorola for the Hytera Defendants' infringement of the Patents-in-Suit, including lost profits suffered by Motorola as a result of the Hytera Defendants' infringement and in an amount not less than a reasonable royalty;

5. For an award of increased damages in an amount not less than three times the damages assessed for each of the Hytera Defendants' infringement of the Patents-in-Suit, in accordance with the 35 U.S.C. § 284;
6. For a declaration that this case is "exceptional" under 35 U.S.C. § 285, and an award to Motorola of its reasonable attorneys' fees, expenses, and costs incurred in this action;
7. For an award of prejudgment and post-judgment interest; and
8. For such other and further relief as this Court shall deem appropriate.

**DEMAND FOR A JURY TRIAL**

Pursuant to Rule 38(b) of the Federal Rules of Civil Procedure, Motorola demands a trial by jury on all issues raised by the Complaint.

DATED: March 15, 2019

Respectfully submitted,

/s/ Adam R. Alper

---

Adam R. Alper (*pro hac vice*)  
adam.alper@kirkland.com  
Akshay S. Deoras (*pro hac vice*)  
akshay.deoras@kirkland.com  
Brandon H. Brown (IL Bar No. 266347 CA)  
bhbrown@kirkland.com  
KIRKLAND & ELLIS LLP  
555 California Street  
San Francisco, California 94104  
Telephone: (415) 439-1400  
Facsimile: (415) 439-1500

Michael W. De Vries (*pro hac vice*)  
michael.devries@kirkland.com  
Ali-Reza Boloori (*pro hac vice*)  
ali-reza.boloori@kirkland.com  
KIRKLAND & ELLIS LLP  
333 South Hope Street  
Los Angeles, California 90071  
Telephone: (213) 680-8400  
Facsimile: (213) 680-8500

David Rokach (IL SBN: 6279703)  
david.rokach@kirkland.com  
KIRKLAND & ELLIS LLP  
300 North LaSalle  
Chicago, IL 60654  
Telephone: (312)862-2000  
Facsimile: (312)862-2200

Attorneys for Plaintiff  
MOTOROLA SOLUTIONS, INC.

**CERTIFICATE OF SERVICE**

I, Adam R. Alper, an attorney, hereby certify that on March 15, 2019, I caused a true and correct copy of the foregoing document to be served via the Court's ECF system upon all counsel of record.

Dated: March 15, 2019

/s/ Adam R. Alper

Adam R. Alper