

**IN THE UNITED STATES DISTRICT COURT
FOR THE EASTERN DISTRICT OF TEXAS
MARSHALL DIVISION**

TRAXCELL TECHNOLOGIES, LLC,	
v.	
AT&T CORP. AND AT&T MOBILITY LLC	No. 2:17-cv-00718-RWS-RSP (LEAD CASE)
SPRINT COMMUNICATIONS COMPANY, LP ET AL.	No. 2:17-cv-00719-RWS-RSP Jury Demand

PLAINTIFF’S FIRST AMENDED COMPLAINT FOR PATENT INFRINGEMENT

Traxcell Technologies, LLC. (“Traxcell”) files this First Amended Complaint,¹ attaching the corrected ‘284 patent, and demand for jury trial seeking relief from patent infringement by Sprint Communications Company, L.P., Sprint Spectrum, L.P. and Sprint Solutions, Inc. (collectively “Defendants”), alleging infringement of the claims of U.S. Pat. No. 8,977,284;² U.S. Pat. No. 9,510,320; U.S. Pat. No. 9,642,024; and, U.S. Pat. No. 9,549,388 (collectively referred to as “Patents-in-Suit”), as follows:

I. THE PARTIES

1. Plaintiff Traxcell is a Texas Limited Liability Company, with its principal place of business located 1405 Municipal Ave., Suite 2305, Plano, TX 75074.
2. Sprint Communications Company, LP is Delaware Corporation with its principal place of business at 6200 Sprint Parkway, Overland Park, Kansas 66251 and a registered agent for service at The Prentice-Hall Corporation System, 211 E. 7th Street, Suite 620, Austin, Texas 78701-3218.

¹ Plaintiff is also filing a Motion for Leave to file this First Amended Complaint after completion of the required Conferences for the Certificate of Conference.

² The only change made by this Second Amended Complaint is to attach the corrected U.S. Pat. No. 8,977,284, correcting claims 1 and 2.

On information and belief, Sprint Communications Company, LP sells and offers to sell products and services throughout Texas, including in this judicial district, and introduces products and services that perform infringing processes into the stream of commerce knowing that they would be sold in Texas and this judicial district.

3. Sprint Corporation is a Delaware Corporation with its principal place of business at 6200 Sprint Parkway, Overland Park, Kansas 66251 and a registered agent for service at Corporation Service Company, 251 Little Falls Drive, Wilmington, Delaware 19808. Sprint Corporation was previously dismissed from the lawsuit and is not a party under this First Amended Complaint.

4. Sprint Spectrum, LP is Delaware Corporation with its principal place of business at 6200 Sprint Parkway, Overland Park, Kansas 66251 and a registered agent for service at Corporation System, 211 E. 7th Street, Suite 620, Austin, Texas 78701-3218. On information and belief, Sprint Spectrum, LP sells and offers to sell products and services throughout Texas, including in this judicial district, and introduces products and services that perform infringing processes into the stream of commerce knowing that they would be sold in Texas and this judicial district.

5. Sprint Solutions, Inc. is Delaware Corporation with its principal place of business at 6200 Sprint Parkway, Overland Park, Kansas 66251 and a registered agent for service at Corporation System, 211 E. 7th Street, Suite 620, Austin, Texas 78701-3218. On information and belief, Sprint Solutions, Inc. sells and offers to sell products and services throughout Texas, including in this judicial district, and introduces products and services that perform infringing processes into the stream of commerce knowing that they would be sold in Texas and this judicial district.

II. JURISDICTION AND VENUE

6. This is an action for patent infringement arising under the patent laws of the U.S., 35 U.S.C. §§ 1 et. seq. This Court has subject matter jurisdiction pursuant to 28 U.S.C. §§ 1331 and 1338(a).

7. This Court has personal jurisdiction over Defendants because: Defendants are present within or has minimum contacts within the State of Texas and this judicial district; Defendants have purposefully availed itself of the privileges of conducting business in the State of Texas and in this judicial district; Defendants regularly conducts business within the State of Texas and within this judicial district; and Plaintiff's cause of action arises directly from Defendants' business contacts and other activities in the State of Texas and in this judicial district.

8. Venue is proper in this district under 28 U.S.C. §§ 1391(b) and 1400(b). On information and belief, Defendants have committed acts of infringement and have a regular and established place of business in this District. Further, venue is proper because Defendants conduct substantial business in this forum, directly or through intermediaries, including: (i) at least a portion of the infringements alleged herein; and (ii) regularly doing or soliciting business, engaging in other persistent courses of conduct and/or deriving substantial revenue from goods and services provided to individuals in Texas and this District.

III. OVERVIEW OF EXEMPLARY ACCUSED INFRINGING TECHNOLOGY -

Sprint WAN

9. Sprint provides a full series of WAN products compatible with 802.11a/b/g/n/ac standards to establish high-speed, secure, and reliable wireless network connections for indoor and outdoor applications. WAN products can be used in enterprise offices, schools, hospitals, large shopping malls, exhibition centers, airports, and more.

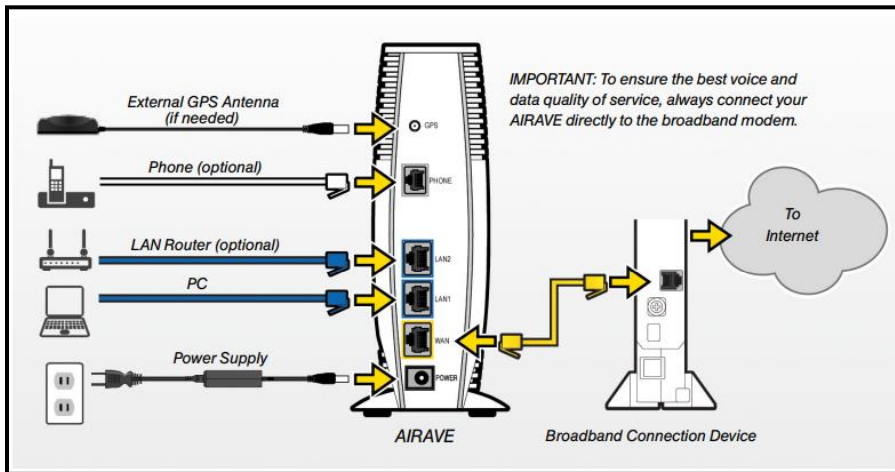

{Source:} – Sprint Airave Access Point

How the AIRAVE™ Access Point Works

The AIRAVE™ Access Point is a *femtocell*, a personal base station with a radio unit that is similar to a cell tower radio. The base station uses a low-power antenna to transmit voice and data cellular signals in your home or small office.

Base stations give you better cellular coverage, which means a stronger signal and improved voice quality. Also, data applications on smartphones, such as mobile email devices, work faster.

The AIRAVE connects to Sprint's network through your broadband Internet connection. Outgoing calls go from the AIRAVE over a secure connection to Sprint's network; incoming calls reverse this route.

- Sprint Airave Access Point

How Calls and Data Go Over the Internet

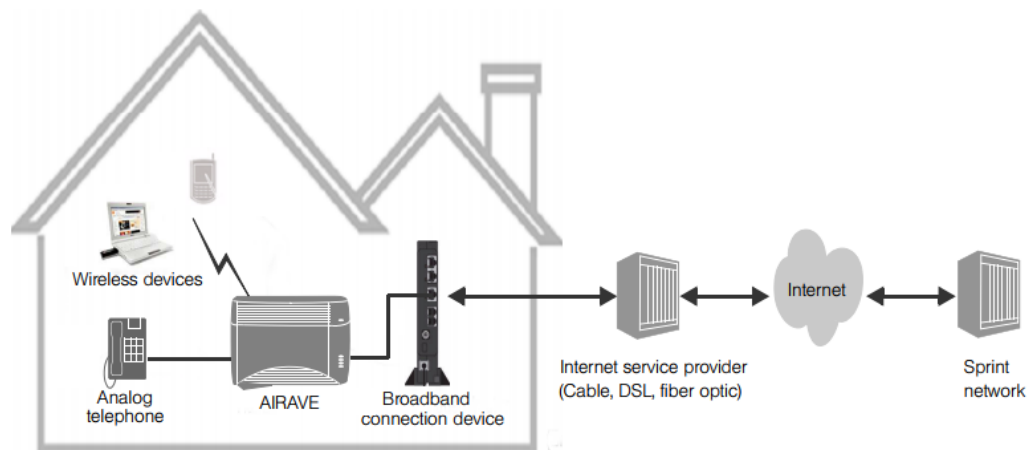

– Sprint Airave Access Point



– Sprint Overdrive 3G/4G Mobile Hotspot AirCard W801

Network Architecture:



1. Sprint Managed Network Solutions

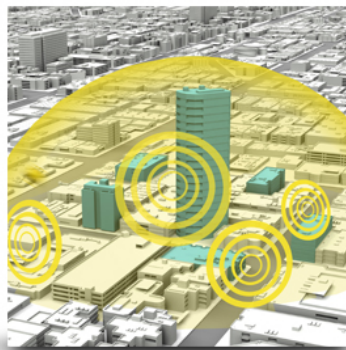

Your entire network. Managed by us.

Sprint management solutions keep your data flowing securely, from your headquarters to your remote locations. From design to implementation, everyday maintenance to long-term planning, our comprehensive suite of managed network, IP telephony, and security solutions -- all backed by industry-recognized technical expertise -- can keep your network running at peak efficiency and prepare it for the future.

Management solutions include:

- * Managed Network Solutions
- * Managed IP Telephony
- * Managed Security Solutions

Source:

http://shop.sprint.com/mysprint/services_solutions/category.jsp?catId=solution_ip_convergence_mgmt&catName=IP

2. Sprint Managed Network Solutions & Net View Performance Manager

MNS Complete Management Services. Sprint will provide the management services listed below in Sections 7.1 through 7.7 (“MNS Complete Management Services”). If Customer terminates the associated Sprint transport or Managed Network Service before the end of the Managed Network Services Order Term, Customer will pay Sprint early termination liabilities for the Managed Network Services specified in Section 2 above. If Customer uses MNS in connection with transport services provided by one carrier and Customer elects to use another carrier to provide transport, customer will pay an additional installation fee associated with the migration to the other carrier. The one-year minimum Order Term for the MNS Services will continue to apply based on customer’s existing contract term with Sprint.

7.1. Network Monitoring and Fault Management. Sprint will provide network monitoring and fault management services 24 hours per day, 365 days per year. These services include the detection, isolation, diagnosis, correction and Customer notification of network troubles. Sprint’s service center operates a Simple Network Management Protocol (SNMP) based management system that provides real-time, graphics-oriented network management of routers/devices and associated communications links. This SNMP management system will be used for the initial screening of all Customer trouble reports. MNS will manage customer’s wide area network (WAN) including the transport and all terminating devices.

Sprint Net View Performance Manager. Sprint Net View Performance Manager is a Sprint managed performance platform that optimizes network operations by monitoring, analyzing and predicting the performance of the Customer’s network. The platform gathers and aggregates performance data from network elements and presents the information on a centralized Sprint web portal. Features include: Near real-time performance statistics to troubleshoot and resolve problems; continuous operations information and historical data for monitoring service level agreements (SLAs); high-level summaries describing overall network performance; and long-term trends for capacity and upgrade planning.

- Sprint Managed Network Solution (MNS) & Net View Performance Manager

3. Sprint Location Based Services

Enhanced Location – “V3”

Enhanced Capabilities for Smart phones

What is “V3?”

- *Server Requested Location of Sprint Devices*
- *Sprint has partnered with Location Labs to provide Network APIs*

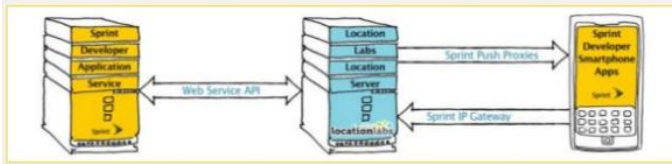

Last Known Network Location

Fast, Inexpensive Network Location

*Per Call Measurement Data (PCMD)
Provided through the Sprint Services Framework*

- Location Recorded with each network connection
- On the order of AFLT quality
- Network initiated location
- Very Low Latency
- Partnering with AirSage

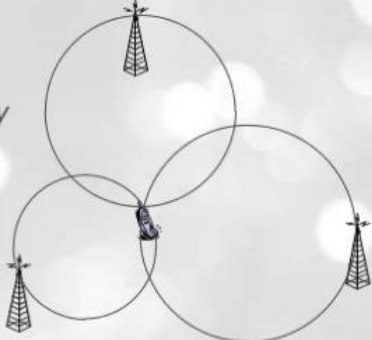

- Sprint Location based Services

4. Sprint Radio Access Network (RAN)

How does Sprint manage its network?

Sprint employs a holistic approach to managing congestion on its data network. Sprint's first goal is to avoid congestion altogether by directing traffic to the best available spectrum resources and cell sites. Sprint also attempts to avoid congestion by managing tonnage on its network. Finally, when congestion does occur, meaning that the demand on a particular sector temporarily exceeds the ability of that sector to meet the demand, Sprint relies on the radio scheduling software provided by Sprint's hardware vendors to allocate resources to users.

Techniques to Direct Traffic to the Best Available Spectrum Resources and Cell Sites: All mobile networks, including Sprint's, employ a Radio Access Network ("RAN") that manages connectivity between mobile client devices and the core network. The RAN functions to identify mobile devices permitted to access the network and their locations and assigns the mobile device to an available frequency band and cell site serving the location. The RAN also controls device "hand off" between neighboring cell site resources to balance load across network resources or as a mobile device moves from one location to another. Sprint's RAN manages connections between mobile devices and cell sites operating on multiple frequency bands (800 MHz, 1.9 GHz, 2.5 GHz) and multiple air interfaces (CDMA, EVDO, LTE). As part of managing those connections, Sprint's RAN is designed to dynamically connect customers to the best available spectrum resources and cell sites—and reassign those connections as circumstances change.

Source:

https://www.sprint.com/legal/open_internet_information.html?ECID=vanity:networkmanagement

5. Sprint Radio Scheduling Software

Allocating Resources During Times of Congestion: Despite its best efforts to prevent congestion through managing tonnage and directing customers to the best available network resources, the demand on a particular network sector sometimes temporarily exceeds the ability of that sector to meet the demand. During these times, Sprint relies on the radio scheduling software provided by Sprint's hardware vendors to allocate resources to users. This radio scheduling software includes a set of generic fairness algorithms that allocate resources based on signal quality, number of users, and other metrics. These algorithms are active at all times, whether or not the cell is congested; however, during times of congestion, the algorithms operate with the goal of ensuring that no single user is deprived of access to the network.

Source:

https://www.sprint.com/legal/open_internet_information.html?ECID=vanity:networkmanagement

6. Sprint Coverage Optimization

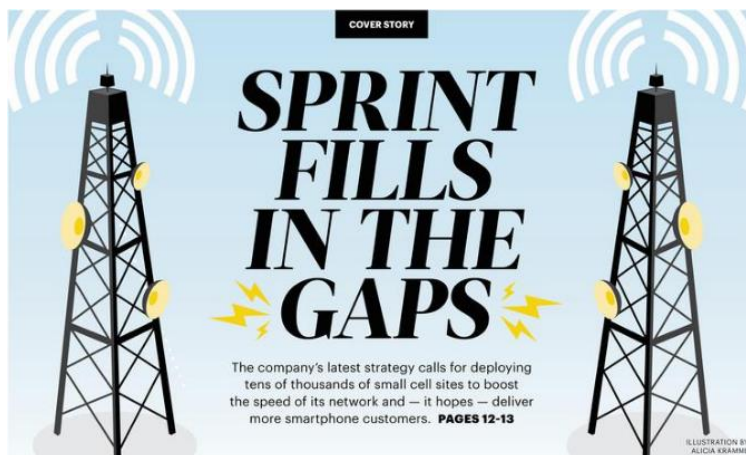

Source: <https://www.bizjournals.com/kansascity/news/2016/01/08/cover-story-sprint-targets-gaps-in-network-and.html>

6. Sprint Intrusion Detection & Prevention Services:

Intrusion detection services help halt, respond to attacks

Don't let a network intrusion go unnoticed. While firewalls keep out bad network traffic, Sprint Intrusion Detection and Prevention Services safeguard your network by monitoring incoming traffic and warning against unauthorized access attempts.

Deployed at critical points within the network, these services can log intrusion information so you can react quickly and protect your intellectual assets.

Source: http://webcache.googleusercontent.com/search?q=cache:SdUYHhdymogJ:shop.sprint.com/mysprint/services_solutions/details.jsp%3FdetId%3Dintrusion_detection%26catId%3Dsolution_ip_convergence_mgmt%26catName%3DIP%2BWAN%2BConvergence%2BManagement%26detName%3DIntrusion%2BDetection/Prevention%26specialCat%3D+&cd=1&hl=en&ct=clnk&gl=in

Sprint WAN – Exemplary Products & Solutions

- Sprint – Airwave Access Point
- Sprint Overdrive 3G/4G Mobile Hotspot
- Sprint Business Wi-Fi (WLAN)
- Sprint Managed WAN Network Solutions
- Sprint Net View Performance Manager
- Sprint Location & Movement Based Services

- Sprint Radio Access Network (RAN)
- Sprint Radio Scheduling Software
- Sprint Coverage Optimization
- Sprint Intrusion Detection & Prevention Services
- Sprint Network Vision

The basic core components involved in each of the aforementioned solutions are the same. Therefore, in this complaint, the term “**Sprint WAN**” has been used to refer to all of the aforementioned Sprint WAN solutions.

IV. INFRINGEMENT (’320 Patent (attached as Exhibit A))

10. On November 29, 2016, U.S. Patent No. 9,510,320 (“the ’320 patent”), attached as Exhibit A, entitled “Machine for Providing a Dynamic Database of Geographic Location Information for a Plurality of Wireless Devices and Process for Making Same” was duly and legally issued by the U.S. Patent and Trademark Office. Traxcell owns the ’320 patent by assignment.

11. The ’320 Patent’s Abstract states, “For a wireless network, a tuning system in which mobile phones using the network are routinely located. With the location of the mobile phones identified, load adjustments for the system are easily accomplished so that the wireless network is not subject to an overload situation. Ideally the location of the mobile phones is accomplished whether the mobile phones are transmitting voice data or not.”

12. The following general elements will be used to explain Plaintiff’s allegations of infringement of the Claims of the ’320 patent.

Element 1: A system including:

at least one radio-frequency transceiver and an associated at least one antenna to which the radio-frequency transceiver is coupled, wherein the at least one radio-frequency transceiver configured for radio-frequency communication with at least one mobile wireless communication device.

Element 2: The said system further including a first computer coupled to the at least one radio-frequency transceiver programmed to locate the at least one mobile wireless device and generate an indication of a location of the at least one mobile wireless device,

Element 3: The said first computer further receives and stores performance data of connections between the at least one mobile wireless device and the radio-frequency transceiver along with the indication of location,

Element 4: The said first computer references the performance data to expected performance data.

Element 5: The said first computer determines at least one suggested corrective action in conformity with differences between the performance data and expected performance data in conjunction with the indication of location.

Element 6: The said first computer routinely stores updated performance data and an updated indication of location of the at least one mobile wireless device while the mobile wireless device is communicating with the at least one radio-frequency transceiver

Element 7: The said system further including a second computer coupled in communication with the first computer.

Element 8: wherein the first computer, responsive to a communication from the at least one mobile wireless communication device, sets a no access flag within a memory of the first computer

Element 9: The said first computer provides access to the indication of location to the second computer if the no access flag is reset and denies access to the indication of location to the second computer if the no access flag is set.

13. Defendants make, use, offer to sell, or sell within or imports into the U.S. wireless networks, wireless-network components, and related services that use identified locations of wireless devices to perform adjustments such that Defendants infringe claims 1–6 of the '320 patent, literally or under the doctrine of equivalents.

A preliminary chart illustrating Plaintiff's claims for infringement of the claim of the '284 patent is as follows:³

Element 1 of Claim #1	Corresponding aspects in use by/marketed by SPRINT
-----------------------	--

³ Plaintiff's infringement claims are not limited to the components provided herein.

<p>A system including at least one radio-frequency transceiver and an associated at least one antenna to which the radio-frequency transceiver is coupled, wherein the at least one radio-frequency transceiver is configured for radio-frequency communication with at least one mobile wireless communication device.</p>	<p>Sprint Managed WAN or Wi-Fi Services provide complete, end-to-end management for your network. The said WAN or Wi-Fi network includes Sprint Airave Access Points i.e. femtocell, a personal base station or Overdrive 3G/4G Mobile Hotspot (AP), each of which acts as a bridge between one or more mobile wireless devices (UEs) and the internet (or an intranet). Each Airave Access Points i.e. femtocell, a personal base station or Overdrive 3G/4G Mobile Hotspot (AP) receives data from a service provider’s server through wired or wireless means and transmits said data wirelessly through RF signals to the UE the said data is meant for. Also, each Airave Access Points (AP) i.e. femtocell, a personal base station or Overdrive 3G/4G Mobile Hotspot (AP) receives data wirelessly through RF signals from a UE and transmits the said data through the service provider’s server to the internet (or an intranet). Each AP can simultaneously service a plurality of UEs in the aforementioned manner.</p> <p>For receiving and transmitting RF signals, these APs have antennas.</p>
---	---

Element 2 of Claim #1	Corresponding aspects in use by/ marketed by SPRINT
<p>The said system further including a first computer coupled to the at least one radio-frequency transceiver programmed to locate the at least one mobile wireless device and generate an indication of a location of the at least one mobile wireless device.</p>	<p>In a WAN or Wi-Fi network supported by Sprint Managed WAN, several Access Points APs are managed by the Sprint Management Solutions.</p> <p>Sprint Management Solutions includes: Managed Network Solutions (MNS) Managed IP Telephony Managed Security Solutions</p> <p>In the normal course of functioning of a WLAN or Wi-Fi network, each of a plurality of APs (radio frequency transceiver) in the WLAN architecture receive and transmit RF signals from and to one or more mobile wireless communication devices (UEs).</p> <p>The Sprint Managed Network Solution (MNS) (Network Manager) partnered with Location enabler companies computes the locations of each of the said UEs from the network data (RSSI). Sprint MNS (Network Manager) correlates the UE location information (corresponding to the time of collection of the corresponding network performance data) with the corresponding network performance data.</p>
Element 3 of Claim #1	Corresponding aspects in use by/ marketed by SPRINT
<p>The said first computer receives and stores performance data of</p>	<p>Sprint Management Solutions includes: Managed Network Solutions (MNS)</p>

<p>connections between the at least one mobile wireless device and the radio frequency transceiver along with the indication of location.</p>	<p>Managed IP Telephony Managed Security Solutions In the normal course of functioning of a WLAN or Wi-Fi network, each of a plurality of APs (radio frequency transceiver) in the WLAN architecture receive and transmit RF signals from and to one or more mobile wireless communication devices (UEs). Performance measurements pertaining to RF signal based wireless interactions between each of the said Access Points APs and the one or more mobile wireless communication device UEs is continuously monitored and reported (or collected) to the Sprint Managed Network Solutions that manages it. Sprint Managed Network Solutions further consists of Sprint Net View Performance Manager which monitors, analyze, manage and predict the performance of the network infrastructure from a single, centralized location constituting the “First Computer”. In a WAN or Wi-Fi network supported by Sprint Managed WAN, Sprint Managed Network Solution (MNS) (“First Computer”) continuously monitors and routinely collects performance measurements pertaining to KPIs (Key Performance Indicators) defining the various aspects (including quality) of the RF signal based interactions between each of a plurality of APs and each of the one or more UEs that each said AP is interacting with. The Sprint Managed Network Solution (MNS) (Network Manager) partnered with Location enabler companies computes the locations of each of the said UEs from the network data (RSSI). Sprint MNS (Network Manager) correlates the UE location information (corresponding to the time of collection of the corresponding network performance data) with the corresponding network performance data. The correlated information is stored by the Sprint Managed Network Solution (MNS) in a database.</p>
---	---

<p>Element 4 of Claim #1</p>	<p>Corresponding aspects in use by/ marketed by SPRINT</p>
<p>The said first computer references the performance data to expected performance data.</p>	<p>Thresholds for performance measurements can be set in the Sprint Net View Performance Manager. Whenever a performance measurement counter value exceeds or violates the corresponding set threshold, an alarm is generated.</p>

<p>Element 5 of Claim #1</p>	<p>Corresponding aspects in use by/ marketed by SPRINT</p>
<p>The said first computer determines at least one suggested corrective action in conformity with differences between the performance data and expected</p>	<p>Analysis of the network performance measurement data collected continuously, correlated with the corresponding UE location information and compiled in real-time by the Sprint Managed Network Solution (MNS) could reveal network performance quality issues or faults for UEs at certain locations in the WAN, like – coverage hole or weak</p>

<p>performance data in conjunction with the indication of location.</p>	<p>signals, interference, handover problems, performance degradation due to overloading of cells (APs) etc.</p> <p>Sprint Managed Network Solution provided network monitoring and management services for detection, isolation, diagnosis and corrections of network problems/faults for UEs. Sprint Network Management solution employ a Radio Access Network (“RAN”) that manages connectivity between mobile client devices and the core network. Sprint’s RAN is designed to dynamically connect customers to the best available spectrum resources and cell sites—and reassign those connections as circumstances change.</p> <p>The demand on a particular network sector sometimes temporarily exceeds the ability of that sector to meet the demand. During these times, Sprint relies on the radio scheduling software provided by Sprint’s hardware vendors to allocate resources to users. This radio scheduling software includes a set of generic fairness algorithms that allocate resources based on signal quality, number of users, and other metrics. These algorithms are active at all times, whether or not the cell is congested; however, during times of congestion, the algorithms operate with the goal of ensuring that no single user is deprived of access to the network.</p>
---	--

Element 6 of Claim #1	Corresponding aspects in use by/marketed by SPRINT
<p>The said first computer routinely stores updated performance data and an updated indication of location of the at least one mobile wireless device while the mobile wireless device is communicating with the at least one radio-frequency transceiver.</p>	<p>In a WAN or Wi-Fi network supported by Sprint Managed WAN, Sprint Managed Network Solution (MNS) (“First Computer”) continuously monitors and routinely collects performance measurements pertaining to KPIs (Key Performance Indicators) defining the various aspects (including quality) of the RF signal based interactions between each of a plurality of APs and each of the one or more UEs that each said AP is interacting with. The Sprint Managed Network Solution (MNS) (Network Manager) partnered with Location enabler companies computes the locations of each of the said UEs from the network data (RSSI). Sprint MNS (Network Manager) correlates the UE location information (corresponding to the time of collection of the corresponding network performance data) with the corresponding network performance data. The correlated information is stored by the Sprint Managed Network Solution (MNS) in a database.</p>

Element 7 of Claim #1	Corresponding aspects
<p>The said system further including a second computer coupled in communication with the first computer, wherein the first</p>	<p>In a WAN or Wi-Fi network supported by Sprint Managed WAN, several Access Points APs are managed by the Sprint Management Solutions.</p>

computer, responsive to a communication from the at least one mobile wireless communication device, sets a no access flag within a memory of the first computer.

Sprint Management Solutions includes:

Managed Network Solutions (MNS)

Managed IP Telephony

Managed Security Solutions

In the normal course of functioning of a WAN or Wi-Fi network, each of a plurality of APs (radio towers) in the WAN architecture receive and transmit RF signals from and to one or more mobile wireless communication devices (UEs).

Performance measurements pertaining to RF signal based wireless interactions between each of the said Access Points APs and the one or more mobile wireless communication device UEs is continuously monitored and reported (or collected) to the Sprint Managed Network Solutions that manages it. Sprint Managed Network Solutions further consists of Sprint Net View Performance Manager which monitors, analyze, manage and predict the performance of the network infrastructure from a single, centralized location constituting the “First Computer”.

The **Sprint Managed Network Solution (MNS) (Network Manager) partnered with Location enabler companies** computes the locations of each of the said UEs from the network data (RSSI). **Sprint MNS (Network Manager)** correlates the UE location information (corresponding to the time of collection of the corresponding network performance data) with the corresponding network performance data. The correlated information is stored by the **Sprint Managed Network Solution (MNS)** in a database.

Sprint provides WAN (Wi-Fi network) for various shopping malls, hotels and academic institutions. In a shopping mall that houses different stores showcasing their products and/or brands, the location information pertaining to customers’ UEs is regularly collected by **Sprint Managed Network Solution (MNS)** in

This information can be provided by the **Sprint Managed Network (MNS)** to applications or programs or service providers that deal with marketing/advertising, providing location / navigation services or collecting data for analytics through a controlled access means, upon request by said applications or programs or service providers. The said applications or programs or service providers represent the “Second Computer”.

When the location of a customer’s UE is detected to be in the vicinity of a store in a shopping mall equipped with **Sprint Wi-Fi network**, the said application or program or service provider can send, through a ‘push’ notification or SMS or voice call, promotional information/offers/coupons concerning the said store’s merchandise.

	<p>The UE location information can also be shared with an Analytics application, which uses this information to ascertain and analyze the distribution of shoppers (UE users) amongst the various stores in the shopping mall.</p> <p>However, a UE user can, at the time of logging-in/authentication/accessing the WAN (Wi-Fi) services, “Deny” letting his location information be shared by the WAN (Wi-Fi service) provider with said applications or programs or service providers. This “Denial” is duly registered at the Sprint Managed Network Solutions responsible for User Authentication and Access control. T This registering of “Denial” by the UE user is referred to as “setting a no access flag”.</p>
--	---

Element 8 of Claim #1	Corresponding aspects
<p>The said first computer provides access to the indication of location to the second computer if the no access flag is reset.</p>	<p>Sprint Managed Network Solution provides access of the client wireless network’s subscriber location information to third-party applications, if and when the corresponding subscribers “opt-in” or “sign-in” their consent for providing said information to the said third-party applications.</p> <p>The said subscribers’ consent is likely obtained by the client wireless network, as is generally the procedure as far as third-party sharing of the subscriber information by the mobile network operators is concerned.</p>

Element 9 of Claim #1	Corresponding aspects
<p>The said first computer denies access to the indication of location to the second computer if the no access flag is set.</p>	<p>When a UE user, at the time of logging-in/authentication/accessing the WAN (Wi-Fi) services, “Denies” letting his location information be shared by the WAN (Wi-Fi service) provider with said applications or programs or service providers, this “Denial” is duly registered by the Sprint Managed Network Solution (MNS) responsible for User Authentication and Access control.</p> <p>Responsive to said “Denial”, the Sprint Managed Network Solution (MNS) exhibit C, does not allow the said applications or programs or service providers to access the said UE user’s UE location information stored in the Sprint Managed Network Solution (MNS) database.</p>

14. Defendants put the inventions claimed by the '320 Patent into service (i.e., used them); but for Defendants' actions, the claimed-inventions embodiments involving Defendants' products and services would never have been put into service. Defendants' acts complained of herein caused those claimed-invention embodiments as a whole to perform, and Defendants obtaining monetary and commercial benefit from it.

15. Defendants have and continues to induce infringement. Defendants have actively encouraged or instructed others (e.g., its customers), and continues to do so, on how to use its products and services (e.g., U.S. wireless networks, wireless-network components [see charts in paragraph 12) that use identified locations of wireless devices to perform adjustments such to cause infringement claims 1–6 of the '320 patent, literally or under the doctrine of equivalents. Moreover, Defendants have known and should have known of the '320 patent, by at least by the date of the patent's issuance, or from the issuance of the '284 patent, which followed the date that the patent's underlying application was cited to Defendants by the U.S. Patent and Trademark Office during prosecution of one of Defendants' patent applications, such that Defendants knew and should have known that it was and would be inducing infringement. In addition, Traxcell submitted its Patent Application to Sprint on August 31, 2007. I then received a rejection email on Sept. 7th, 2007, from Steven J. Funk, a patent attorney in Sprint's legal department, who states that "Sprint Nextel has no interest in buying or licensing your patent application". Sprint was first notified about Traxcell's patent application by a USPTO Examiner in about 2005-2006.

16. Defendants have caused and will continue to cause Traxcell damage by infringing (including inducing infringement of) the '320 patent.

V. INFRINGEMENT ('284 Patent (attached as Exhibit B))⁴

⁴ The only change made by this Second Amended Complaint is to attach the corrected U.S. Pat. No. 8,977,284.

17. On March 10, 2015, U.S. Patent No. 8,977,284 (“the ’284 patent”), attached as Exhibit B, entitled “Machine for Providing a Dynamic Database of Geographic Location Information for a Plurality of Wireless Devices and Process for Making Same” was duly and legally issued by the U.S. Patent and Trademark Office. Traxcell owns the ’284 patent by assignment.

18. The ’284 Patent’s Abstract states, “For a wireless network, a tuning system in which mobile phones using the network are routinely located. With the location of the mobile phones identified, load adjustments for the system are easily accomplished so that the wireless network is not subject to an overload situation. Ideally the location of the mobile phones is accomplished whether the mobile phones are transmitting voice data or not.”

19. The following general elements will be used to explain Plaintiff’s allegations of infringement of the Claims of the ’284 patent.

Element 1: A wireless network comprising at least two wireless devices, each said wireless device communicating via radio frequency signals;

Element 2: The said wireless network further comprises a first computer programmed to perform the steps of:

- 1) locating at least one said wireless device on said wireless network and referencing performance of said at least one wireless device with wireless network known parameters,
- 2) routinely storing performance data and a corresponding location for said at least one wireless device in a memory;

Element 3: The said wireless network further comprises a radio tower adapted to receive radio frequency signals from, and transmit radio frequency signals to said at least one wireless device

Element 4: The said first computer further includes means for receiving said performance data and suggest corrective actions obtained from a list of possible causes for said radio

tower based upon the performance data and the corresponding location associated with said at least one wireless device.

Element 5: The said radio tower generates an error code based upon operation of said at least one wireless device

Element 6: The said first computer further programmed to,

- 1) receive said error code from said radio tower, and,
- 2) selectively suggest a corrective action of said radio frequency signals of said radio tower in order to restrict processing of radio frequency signals from at least one of said at least two wireless devices based upon said error code, and, whereby said first computer suggests said corrective action in order to improve communication with at least one said wireless device.

20. Defendants make, use, offer to sell, or sell within or import into the U.S. wireless networks, wireless-network components, and related services that use identified locations of wireless devices to perform adjustments such that Defendants infringes one or more claims of the '284 patent, including—for example—Claims 1 - 12, literally or under the doctrine of equivalents.

A preliminary chart illustrating Plaintiff's claims for infringement of the claim of the '284 patent is as follows:⁵

⁵ Plaintiff's infringement claims are not limited to the components provided herein.

Element 1 of Claim #1	Corresponding aspects
<p>A wireless network comprising: at least two wireless devices, each said wireless device communicating via radio frequency signals; a radio tower adapted to receive radio frequency signals from, and transmit radio frequency signals to said wireless devices.</p>	<p>Sprint Managed WAN or Wi-Fi Services provide complete, end-to-end management for your network. The said WAN or Wi-Fi network includes Airave Access Points i.e. femtocell, a personal base station or Overdrive 3G/4G Mobile Hotspot (AP), each of which acts as a bridge between one or more mobile wireless devices (UEs) and the internet (or an intranet). Each Airave Access Points i.e. femtocell, a personal base station or Overdrive 3G/4G Mobile Hotspot (AP) receives data from a service provider’s server through wired or wireless means and transmits said data wirelessly through RF signals to the UE the said data is meant for. Also, each Airave Access Points (AP) i.e. femtocell, a personal base station or Overdrive 3G/4G Mobile Hotspot (AP) receives data wirelessly through RF signals from a UE and transmits the said data through the service provider’s server to the internet (or an intranet). Each AP can simultaneously service a plurality of UEs in the aforementioned manner.</p>

Element 2 of Claim #1	Corresponding aspects
<p>The said wireless network further comprising a first computer, which includes means for receiving performance data of said RF-based interactions between the said radio tower and said wireless devices.</p>	<p>In a WAN or Wi-Fi network supported by Sprint Managed WAN, several Access Points APs are managed by the Sprint Management Solutions.</p> <p>Sprint Management Solutions includes: Managed Network Solutions (MNS) Managed IP Telephony Managed Security Solutions</p> <p>In the normal course of functioning of a WLAN or Wi-Fi network, each of a plurality of APs (radio towers) in the WLAN architecture receive and transmit RF signals from and to one or more mobile wireless communication devices (UEs).</p> <p>Performance measurements pertaining to RF signal based wireless interactions between each of the said Access Points APs and the one or more mobile wireless communication device UEs is continuously monitored and reported (or collected) to the Sprint Managed Network Solutions that manages it. Sprint Managed Network Solutions further consists of Sprint Net View Performance Manager which monitors,</p>

	analyze, manage and predict the performance of the network infrastructure from a single, centralized location constituting the “First Computer”.
--	--

Element 3 of Claim #1	Corresponding aspects
<p>wherein the said first computer is further programmed to perform the steps of:</p> <p style="padding-left: 20px;">locating at least one said wireless device on said wireless network and referencing performance of said at least one wireless device with wireless network known parameters; and routinely storing performance data and a corresponding location for said at least one wireless device in a memory.</p>	<p>In a WAN or Wi-Fi network supported by Sprint Managed WAN, Sprint Managed Network Solution (MNS) (“First Computer”) continuously monitors and routinely collects performance measurements pertaining to KPIs (Key Performance Indicators) defining the various aspects (including quality) of the RF signal based interactions between each of a plurality of APs and each of the one or more UEs that each said AP is interacting with. The Sprint Managed Network Solution (MNS) (Network Manager) partnered with Location enabler companies computes the locations of each of the said UEs from the network data (RSSI). Sprint MNS (Network Manager) correlates the UE location information (corresponding to the time of collection of the corresponding network performance data) with the corresponding network performance data. The correlated information is stored by the Sprint Managed Network Solution (MNS) in a database.</p>

Element 4 of Claim #1	Corresponding aspects
<p>wherein said first computer further includes means for suggesting corrective actions obtained from a list of possible causes for said radio tower based upon the performance data and the corresponding location associated with said at least one wireless device.</p>	<p>Analysis of the network performance measurement data collected continuously, correlated with the corresponding UE location information and compiled in real-time by the Sprint Managed Network Solution (MNS) could reveal network performance quality issues or faults for UEs at certain locations in the WAN, like – coverage hole or weak signals, interference, handover problems, performance degradation due to overloading of cells (APs) etc. Sprint Managed Network Solution provided network monitoring and management services for detection, isolation, diagnosis and corrections of network problems/faults for UEs. Sprint Network Management solution employ a Radio Access Network (“RAN”) that manages connectivity between mobile client devices and the core network. Sprint’s RAN is designed to dynamically connect customers to the best available spectrum resources and cell sites—and reassign those connections as circumstances change. The demand on a particular network sector sometimes temporarily exceeds the ability of that sector to meet the demand. During these times, Sprint relies on the radio scheduling software provided by</p>

	<p>Sprint’s hardware vendors to allocate resources to users. This radio scheduling software includes a set of generic fairness algorithms that allocate resources based on signal quality, number of users, and other metrics. These algorithms are active at all times, whether or not the cell is congested; however, during times of congestion, the algorithms operate with the goal of ensuring that no single user is deprived of access to the network.</p>
--	--

Element 5 of Claim #1	Corresponding aspects
<p>wherein said radio tower generates an error code based upon operation of said at least one wireless device, and wherein said first computer is further programmed to receive said error code from said radio tower.</p>	<p>In a WAN or Wi-Fi network supported by Sprint, performance measurements pertaining to RF signal based interactions between the APs and the UEs is continuously monitored and collected by the Sprint Network Management Solutions (NMS). Each AP continuously communicates to the Sprint radio scheduling software the number of UEs it is servicing at that point of time and also the traffic volume on it at that point of time. Each AP at any given point of time, by default can only service a number of UEs not exceeding a pre-set maximum number. When the number of UEs being serviced at a given point of time nears or equals the said pre-set maximum number (or any other pre-set threshold), the said AP raises an “alarm”. This alarm is communicated in real-time to the Sprint radio scheduling software (i.e. first computer). The demand on a particular network sector sometimes temporarily exceeds the ability of that sector to meet the demand (i.e. Overload occurs). During these times, Sprint relies on the radio scheduling software provided by Sprint’s hardware vendors to allocate resources to users. This radio scheduling software includes a set of generic fairness algorithms that allocate resources based on signal quality, number of users, and other metrics. These algorithms are active at all times, whether or not the cell is congested; however, during times of congestion, the algorithms operate with the goal of ensuring that no single user is deprived of access to the network.</p> <p>Sprint Network Management Solution (NMS) provides Intrusion detection and prevention services for safeguard the network by monitoring incoming traffic and warning against unauthorized access attempts.</p> <p>When an AP receives association requests from new UEs. It collects the UE details (like MAC address, frame type, device type etc.) and communicates the list of UEs to Sprint Network Management (NMS) which compares the said list against a list of authorized UEs. If any of the UEs detected by the AP are not found in the authorized UEs list, the Sprint NMS identifies the said UEs as un-authorized</p>

	UEs and determines the association attempt as an “Intrusion” attempt.
--	---

Element of Claim #1	Corresponding aspects
<p>wherein said first computer is further programmed to, selectively suggest a corrective action of said radio frequency signals of said radio tower to restrict processing of radio frequency signals from at least one of said at least two wireless devices based upon said error code, and, whereby said first computer suggests said corrective action in order to improve communication with at least one said wireless device.</p>	<p>When a Sprint radio scheduling software determines that an AP is “Overloaded” it directs the said AP to reject any fresh association requests from new UEs (UEs that aren’t already being serviced by the said AP). The Sprint radio scheduling software automatically distributes the said new UEs to neighboring APs with less load. If new UEs associate with an “Overloaded” AP, all the UEs serviced by the said AP would experience service quality degradation. Therefore, in order to prevent service quality degradation to the UEs being serviced by the said AP, the Sprint radio scheduling software directs the said AP not to associate with any new UEs and to reject any fresh association requests from new UEs. Using Sprint Intrusion detection & prevention services when rogue devices or un-authorized UEs in a UE list reported by an AP is identified, it sends the rogue device list to the said AP and directs the said AP to take countermeasure by sending a unicast deauthentication frame to each of the un-authorized UEs, preventing the un-authorized UEs from connecting to the wireless network.</p>

21. Defendants put the inventions claimed by the ’284 Patent into service (i.e., used them); but for Defendants’ actions, the claimed-inventions embodiments involving Defendants’ products and services would never have been put into service. Defendants’ acts complained of herein caused those claimed-invention embodiments as a whole to perform, and Defendants obtaining monetary and commercial benefit from it.

22. Defendants have and continues to induce infringement. Defendants have actively encouraged or instructed others (e.g., its customers), and continues to do so, on how to use its products and services (see charts in paragraph 19, and related products and services) that use identified locations of wireless devices to perform adjustments such to cause infringement one or

more claims of the '284 patent, including—for example—Claims 1 - 12, literally or under the doctrine of equivalents. Moreover, Defendants have known and should have known of the '284 patent, by at least by the date of the patent's issuance, which followed the date that the patent's underlying application was cited to Defendants by the U.S. Patent and Trademark Office during prosecution of one of Defendants' patent applications, such that Defendants knew and should have known that it was and would be inducing infringement. In addition, Traxcell submitted its Patent Application to Sprint on August 31, 2007. I then received a rejection email on Sept. 7th, 2007, from Steven J. Funk, a patent attorney in Sprint's legal department, who states that "Sprint Nextel has no interest in buying or licensing your patent application". Sprint was first notified about Traxcell's patent application by a USPTO Examiner in about 2005-2006.

23. Defendants have caused and will continue to cause Traxcell damage by infringing (including inducing infringement of) the '284 patent.

A. INFRINGEMENT ('024 Patent (Attached as exhibit C))

24. On May 2, 2017, U.S. Patent No. 9,642,024 ("the '024 patent") entitled "Machine for Providing a Dynamic Database of Geographic Location Information for a Plurality of Wireless Devices and Process for Making Same" was duly and legally issued by the U.S. Patent and Trademark Office. Traxcell owns the '024 patent by assignment.

25. The '024 Patent's Abstract states, "For a wireless network, a tuning system in which mobile phones using the network are routinely located. With the location of the mobile phones identified, load adjustments for the system are easily accomplished so that the wireless network is not subject to an overload situation. Ideally the location of the mobile phones is accomplished whether the mobile phones are transmitting voice data or not."

26. The following general elements will be used to explain Plaintiff's allegations of infringement of the Claims of the '024 patent.

Element 1: A system including one or more radio-frequency transceivers and an associated one or more antennas to which the radio-frequency transceiver is coupled, wherein the one or more radio-frequency transceivers configured for radio-frequency communication with at least one mobile wireless communications device.

Element 2: The said system further including a computer coupled to the one or more radio-frequency transceivers programmed to locate the one or more mobile wireless communications devices and generate an indication of a location of the one or more mobile wireless communications devices.

Element 3: The said first computer receives and stores performance data of connections between the one or more mobile wireless communications devices and the radio-frequency transceiver along with the indication of location.

Element 4: The said first computer references the performance data to expected performance data.

Element 5: The said first computer determines at least one suggested corrective action in conformity with differences between the performance data and expected performance data in conjunction with the indication of location.

Element 6: The said first computer receives an error code from the radio-frequency transceiver, determines whether the error code indicates a performance issue with respect to the connection between the one or more mobile wireless communications devices and the radio-frequency transceiver.

Element 7: The said first computer determines the at least one suggested corrective action in response to the error code.

27. Defendants make, use, offer to sell, or sell within or import into the U.S. wireless networks, wireless-network components, and related services that use identified locations of wireless devices to perform adjustments such that Defendants infringe one or more claims of the '024 patent, including—for example, but not by way of limitation—Claims 1-22, literally or under the doctrine of equivalents.

Preliminary charts illustrating Plaintiff’s claims for infringement of the claims of the ‘024

patent is as follows:⁶

Element 1 of Claim #1	Corresponding aspects in use by/marketed by SPRINT
<p>A system including one or more radio-frequency transceivers and an associated one or more antennas to which the radio-frequency transceiver is coupled, wherein the one or more radio-frequency transceivers configured for radio-frequency communication with at least one mobile wireless communications device</p>	<p>Sprint Managed WAN or Wi-Fi Services provide complete, end-to-end management for your network. The said WAN or Wi-Fi network includes Sprint Airave Access Points i.e. femtocell, a personal base station or Overdrive 3G/4G Mobile Hotspot (AP), each of which acts as a bridge between one or more mobile wireless devices (UEs) and the internet (or an intranet). Each Airave Access Points i.e. femtocell, a personal base station or Overdrive 3G/4G Mobile Hotspot (AP) receives data from a service provider’s server through wired or wireless means and transmits said data wirelessly through RF signals to the UE the said data is meant for. Also, each Airave Access Points (AP) i.e. femtocell, a personal base station or Overdrive 3G/4G Mobile Hotspot (AP) receives data wirelessly through RF signals from a UE and transmits the said data through the service provider’s server to the internet (or an intranet). Each AP can simultaneously service a plurality of UEs in the aforementioned manner.</p> <p>For receiving and transmitting RF signals, these APs have antennas.</p>

Element 2 of Claim #1	Corresponding aspects in use by/marketed by SPRINT
<p>The said system further including a computer coupled to the one or more radio-frequency transceivers programmed to locate the one or more mobile wireless communications devices and generate an indication of a location of the one or more mobile wireless communications devices</p>	<p>In a WAN or Wi-Fi network supported by Sprint Managed WAN, several Access Points APs are managed by the Sprint Management Solutions.</p> <p>Sprint Management Solutions includes: Managed Network Solutions (MNS) Managed IP Telephony Managed Security Solutions</p> <p>In the normal course of functioning of a WLAN or Wi-Fi network, each of a plurality of APs (radio frequency transceiver) in the WLAN architecture receive and transmit RF signals from and to one or more mobile wireless communication devices (UEs). The Sprint Managed Network Solution (MNS) (Network Manager) partnered with Location enabler companies computes the locations of each of the said UEs from the network data (RSSI). Sprint MNS (Network Manager) correlates the UE location information (corresponding to the time of collection of the corresponding network performance data) with the corresponding network performance data.</p>

⁶ Plaintiff’s infringement claims are not limited to the components provided herein.

Element 3 of Claim #1	Corresponding aspects in use by/ marketed by SPRINT
<p>The said first computer receives and stores performance data of connections between the one or more mobile wireless communications devices and the radio-frequency transceiver along with the indication of location</p>	<p>Sprint Management Solutions includes: Managed Network Solutions (MNS) Managed IP Telephony Managed Security Solutions</p> <p>In the normal course of functioning of a WAN or Wi-Fi network, each of a plurality of APs (radio frequency transceiver) in the WAN architecture receive and transmit RF signals from and to one or more mobile wireless communication devices (UEs). Performance measurements pertaining to RF signal based wireless interactions between each of the said Access Points APs and the one or more mobile wireless communication device UEs is continuously monitored and reported (or collected) to the Sprint Managed Network Solutions that manages it.</p> <p>Sprint Managed Network Solutions further consists of Sprint Net View Performance Manager which monitors, analyze, manage and predict the performance of the network infrastructure from a single, centralized location constituting the “First Computer”.</p> <p>In a WAN or Wi-Fi network supported by Sprint Managed WAN, Sprint Managed Network Solution (MNS) (“First Computer”) continuously monitors and routinely collects performance measurements pertaining to KPIs (Key Performance Indicators) defining the various aspects (including quality) of the RF signal based interactions between each of a plurality of APs and each of the one or more UEs that each said AP is interacting with. The Sprint Managed Network Solution (MNS) (Network Manager) partnered with Location enabler companies computes the locations of each of the said UEs from the network data (RSSI). Sprint MNS (Network Manager) correlates the UE location information (corresponding to the time of collection of the corresponding network performance data) with the corresponding network performance data. The correlated information is stored by the Sprint Managed Network Solution (MNS) in a database.</p>

Element 4 of Claim #1	Corresponding aspects in use by/ marketed by SPRINT
<p>The said first computer references the performance data to expected performance data</p>	<p>Thresholds for performance measurements can be set in the Sprint Net View Performance Manager. Whenever a performance measurement counter value exceeds or violates the corresponding set threshold, an alarm is generated.</p>

--	--

Element 5 of Claim #1	Corresponding aspects in use by/marketed by SPRINT
<p>The said first computer determines at least one suggested corrective action in conformity with differences between the performance data and expected performance data in conjunction with the indication of location</p>	<p>Analysis of the network performance measurement data collected continuously, correlated with the corresponding UE location information and compiled in real-time by the Sprint Managed Network Solution (MNS) could reveal network performance quality issues or faults for UEs at certain locations in the WAN, like – coverage hole or weak signals, interference, handover problems, performance degradation due to overloading of cells (APs) etc.</p> <p>Sprint Managed Network Solution provided network monitoring and management services for detection, isolation, diagnosis and corrections of network problems/faults for UEs. Sprint Network Management solution employ a Radio Access Network (“RAN”) that manages connectivity between mobile client devices and the core network. Sprint’s RAN is designed to dynamically connect customers to the best available spectrum resources and cell sites—and reassign those connections as circumstances change.</p> <p>The demand on a particular network sector sometimes temporarily exceeds the ability of that sector to meet the demand. During these times, Sprint relies on the radio scheduling software provided by Sprint’s hardware vendors to allocate resources to users. This radio scheduling software includes a set of generic fairness algorithms that allocate resources based on signal quality, number of users, and other metrics. These algorithms are active at all times, whether or not the cell is congested; however, during times of congestion, the algorithms operate with the goal of ensuring that no single user is deprived of access to the network.</p>

Element 6 of Claim #1	Corresponding aspects in use by/marketed by SPRINT
<p>The said first computer receives an error code from the radio-frequency transceiver, determines whether the error code indicates a performance issue with respect to the connection between the one or more mobile wireless communications devices and the radio-frequency transceiver</p>	<p>In a WAN or Wi-Fi network supported by Sprint, performance measurements pertaining to RF signal based interactions between the APs and the UEs is continuously monitored and collected by the Sprint Network Management Solutions (NMS). Each AP continuously communicates to the Sprint radio scheduling software the number of UEs it is servicing at that point of time and also the traffic volume on it at that point of time. Each AP at any given point of time, by default can only service a number of UEs not exceeding a pre-set maximum number. When the number of UEs being serviced at a given point of time nears or equals the said pre-set maximum number (or any other pre-set threshold), the said AP raises an “alarm”. This alarm is communicated in real-time to the Sprint radio scheduling software (i.e. first computer).</p> <p>The demand on a particular network sector sometimes temporarily exceeds the ability of that sector to meet the demand (i.e. Overload occurs). During these times, Sprint relies on the radio scheduling software provided by Sprint’s hardware vendors to allocate resources to users. This</p>

	<p>radio scheduling software includes a set of generic fairness algorithms that allocate resources based on signal quality, number of users, and other metrics. These algorithms are active at all times, whether or not the cell is congested; however, during times of congestion, the algorithms operate with the goal of ensuring that no single user is deprived of access to the network.</p> <p>Sprint Network Management Solution (NMS) provides Intrusion detection and prevention services for safeguard the network by monitoring incoming traffic and warning against unauthorized access attempts.</p> <p>When an AP receives association requests from new UEs. It collects the UE details (like MAC address, frame type, device type etc.) and communicates the list of UEs to Sprint Network Management (NMS) which compares the said list against a list of authorized UEs. If any of the UEs detected by the AP are not found in the authorized UEs list, the Sprint NMS identifies the said UEs as un-authorized UEs and determines the association attempt as an “Intrusion” attempt.</p>
--	---

Element 7 of Claim #1	Corresponding aspects in use by/marketed by SPRINT
<p>The said first computer determines the at least one suggested corrective action in response to the error code</p>	<p>When a Sprint radio scheduling software determines that an AP is “Overloaded” it directs the said AP to reject any fresh association requests from new UEs (UEs that aren’t already being serviced by the said AP). The Sprint radio scheduling software automatically distributes the said new UEs to neighboring APs with less load.</p> <p>If new UEs associate with an “Overloaded” AP, all the UEs serviced by the said AP would experience service quality degradation. Therefore, in order to prevent service quality degradation to the UEs being serviced by the said AP, the Sprint radio scheduling software directs the said AP not to associate with any new UEs and to reject any fresh association requests from new UEs. Using Sprint Intrusion detection & prevention services when rogue devices or un-authorized UEs in a UE list reported by an AP is identified, it sends the rogue device list to the said AP and directs the said AP to take countermeasure by sending a unicast deauthentication frame to each of the un-authorized UEs, preventing the un-authorized UEs from connecting to the wireless network.</p>

28. Defendants put the inventions claimed by the '024 Patent into service (i.e., used them); but for Defendants’ actions, the claimed-inventions embodiments involving Defendants’ products and services would never have been put into service. Defendants’ acts complained of herein caused

those claimed-invention embodiments as a whole to perform, and Defendants obtaining monetary and commercial benefit from it.

29. Defendants have and continues to induce infringement. Defendants have actively encouraged or instructed others (e.g., its customers), and continues to do so, on how to use its products and services (see charts in paragraph 26), and related services) that use identified locations of wireless devices to perform adjustments such to cause infringement one or more claims of the '024 patent, including—for example—Claims 1-22, literally or under the doctrine of equivalents. Moreover, Defendants have known and should have known of the '024 patent, if not by the issuance of the '284 patent, by at least by the date of the patent's issuance, which followed the date that the patent's underlying application was cited to Defendants by the U.S. Patent and Trademark Office during prosecution of one of Defendants' patent applications, such that Defendants knew and should have known that it was and would be inducing infringement. In addition, Traxcell submitted its Patent Application to Sprint on August 31, 2007. I then received a rejection email on Sept. 7th, 2007, from Steven J. Funk, a patent attorney in Sprint's legal department, who states that "Sprint Nextel has no interest in buying or licensing your patent application". Sprint was first notified about Traxcell's patent application by a USPTO Examiner in about 2005-2006.

30. Defendants have caused and will continue to cause Traxcell damage by infringing (including inducing infringement of) the '024 patent.

VI. INFRINGEMENT ('388 Patent (Attached as exhibit D))

31. On January 17, 2017, U.S. Patent No. 9,549,388 ("the '388 patent") entitled "Mobile wireless device providing off-line and on-line geographic navigation information" (attached as

Exhibit D) was duly and legally issued by the U.S. Patent and Trademark Office. Traxcell owns the '388 patent by assignment.

32. The '388 Patent's Abstract states, "A mobile device, wireless network and their method of operation provide both on-line (connected) navigation operation, as well as off-line navigation from a local database within the mobile device. Routing according to the navigation system can be controlled by traffic congestion measurements made by the wireless network that allow the navigation system to select the optimum route based on expected trip duration."

33. The following general elements will be used to explain Plaintiff's allegations of infringement of the Claims of the '388 patent.

Element 1: A wireless communications system including a first radio-frequency transceiver within a wireless mobile communications device and an associated first antenna to which the first radio-frequency transceiver is coupled, wherein the first radio-frequency transceiver is configured for radio-frequency communication with a wireless communications network.

Element 2: The said system further including a first processor within the wireless mobile communications device coupled to the at least one first radio-frequency transceiver programmed to receive a location of the wireless mobile communications device from the wireless communications network and generate an indication of a location of the wireless mobile communications device with respect to geographic features according to mapping information stored within the wireless mobile communications device.

Element 3: The said first processor displays to the user navigation information according to the location of the wireless mobile communications device with respect to the geographic features and a destination specified by the user at the wireless mobile communications device.

Element 4: The said system further comprising, at least one second radio-frequency transceiver and an associated at least one second antenna of the wireless communications network to which the second radio-frequency transceiver is coupled.

Element 5: The said system further comprising, a second processor coupled to the at least one second radio-frequency transceiver programmed to determine the location of the wireless mobile communications device.

Element 6: The said second processor selectively determines the location of the wireless mobile communications device dependent on the setting of preference flags.

Element 7: The said second processor determines the location of the wireless mobile communications device if the preference flags are set to a state that permits tracking of the

user of the wireless mobile communications device and communicates the location of the wireless mobile communications device to the first processor via the second radio-frequency transmitter.

Element 8: The said second processor does not determine and communicate the location of the wireless mobile communications device if the preference flags are set to a state that prohibits tracking of the wireless mobile communications device.

34. Defendants make, use, offer to sell, or sell within or import into the U.S. wireless networks, wireless-network components, and related services that use online and/or off-line navigation such that Defendants infringe one or more claims of the '388 patent, including—for example, but not by way of limitation—Claims 1-30, literally or under the doctrine of equivalents.

Preliminary charts illustrating Plaintiff's claims for infringement of the claims of the '388 patent is as follows:⁷

Telenav's Application for Sprint

➤ Scout

⁷ Plaintiff's infringement claims are not limited to the components provided herein.

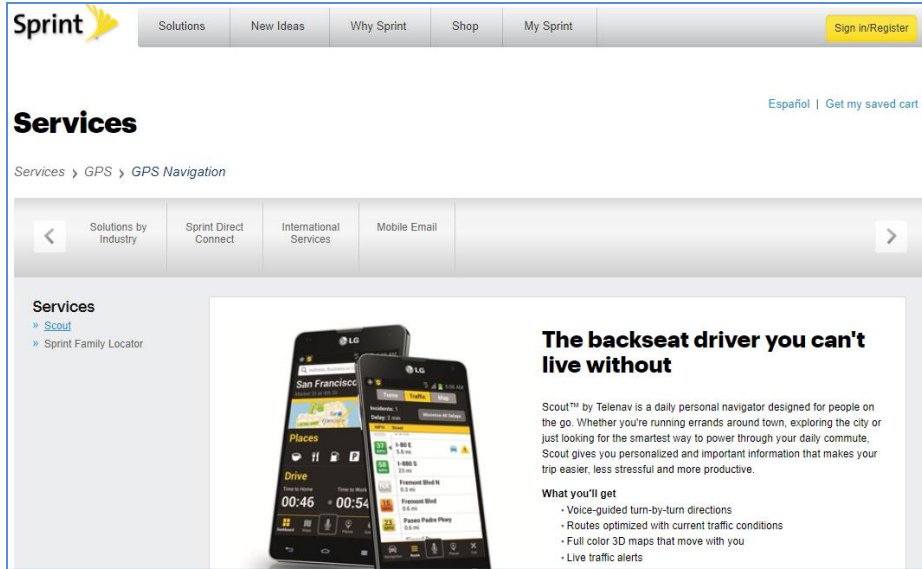

Source:

http://shop.sprint.com/mysprint/services_solutions/details.jsp?detId=gps_navigation&catId=service_gps&catName=GPS&detName=GPS+Navigation

Element of Claim #1	Corresponding aspects
<p>A wireless communications system including a first radio-frequency transceiver within a wireless mobile communications device and an associated first antenna to which the first radio-frequency transceiver is coupled, wherein the first radio-frequency transceiver is configured for radio-frequency communication with a wireless communications network.</p>	<p>Most of the wireless communication device (such as Samsung Galaxy Note 4, Samsung Galaxy Note 3, HTC 8XT) from Sprint communications network comes preloaded with Scout application. These Wireless communication devices are equipped with radio transceiver and antenna for communication.</p> <p>Samsung Galaxy Note 4 teardown shows that it has Qualcomm WTR1625L RF Transceiver. Further, the teardown shows that Samsung Galaxy Note 4 has antennas coupled to the RF transceiver.</p>
Element of Claim #1	Corresponding aspects
<p>The said system further including a first processor within the wireless mobile communications device coupled to the at least one</p>	<p>The wireless communication device such as Samsung Galaxy Note 3, Note 4, HTC 8XT, etc., includes processors. Samsung Galaxy Note 4 has Quad-core 2.7 GHz Krait 450 - Snapdragon 805 processor.</p>

<p>first radio-frequency transceiver programmed to receive a location of the wireless mobile communications device from the wireless communications network and generate an indication of a location of the wireless mobile communications device with respect to geographic features according to mapping information stored within the wireless mobile communications device.</p>	<p>The Scout navigation application estimates/receives the location of the wireless communication device such as Samsung Galaxy Note 3, Note 4, HTC 8XT etc., by utilizing Cellular networks {Sprint communication network} or by utilizing both Sprint communication network and GPS.</p> <p>The maps for Scout navigation based application comes from the Scout wireless network Navigator hardware/software using data plan or WIFI network and hence are stored within the memory of wireless communication device.</p> <p>The arrow pointer on the Scout map indicates the location of the wireless communication device, with respect to the various geographical features such as streets, cities, or any point of interest.</p>
<p>Element of Claim #1</p>	<p>Corresponding aspects</p>
<p>The said first processor displays to the user navigation information according to the location of the wireless mobile communications device with respect to the geographic features and a destination specified by the user at the wireless mobile communications device.</p>	<p>The wireless communication device such as Samsung Galaxy Note 3, Note 4, HTC 8XT etc., having Scout navigation application, displays to the user navigation information, based on the destination entered by the user.</p> <p>The Scout navigation application estimates/receives the location of the Wireless communication device such as Samsung Galaxy Note 4, by utilizing Cellular networks {Sprint communication network} or by utilizing both Sprint communication network and GPS, and indicates it on the map with respect of various geographic features such as streets, cities, or any point of interest. The Scout navigation application provides route from present location to the destination entered by the user on the wireless communication device.</p>

<p>Element of Claim #1</p>	<p>Corresponding aspects in use by/ marketed by M/S AT&T</p>
<p>The said system further comprising, at least one second radio-frequency transceiver and an associated at least one second antenna of the wireless communications network to which the</p>	<p>Scout navigation application communicates to Sprint Network Navigator hardware/software through Sprint's communication network. The Sprint's communication network includes cell towers which provide radio communication to and from mobile devices. Thus, the cell towers are the radio frequency transceiver coupled with antenna in Sprint's communication network.</p>

<p>second radio-frequency transceiver is coupled.</p>	
---	--

Element of Claim #1	Corresponding aspects
<p>The said system further comprising, a second processor coupled to the at least one second radio-frequency transceiver programmed to determine the location of the wireless mobile communications device.</p>	<p>Scout navigation application communicates to Sprint Network Navigator hardware/software through Sprint’s communication network. The Sprint’s communication network includes cell towers which provide radio communication to and from mobile devices. Thus, the cell towers include the radio frequency transceiver in Sprint’s communication network.</p> <p>Sprint’s communication network allows communication between Sprint Network Navigator hardware/software and the wireless communication device such as Samsung Galaxy Note 3, Note 4, HTC 8XT etc., to determine the current location of the wireless communication device.</p>

Element of Claim #1	Corresponding aspects
<p>The said second processor selectively determines the location of the wireless mobile communications device dependent on the setting of preference flags</p>	<p>The Sprint Network Navigator hardware/software will only be able to determine the location of the Wireless communication device such as Samsung Galaxy Note 3, Note 4, HTC 8XT etc., if the location flag on the Wireless communication device is turned “ON”.</p>

Element of Claim #1	Corresponding aspects
---------------------	-----------------------

<p>The said second processor determines the location of the wireless mobile communications device if the preference flags are set to a state that permits tracking of the user of the wireless mobile communications device and communicates the location of the wireless mobile communications device to the first processor via the second radio-frequency transmitter.</p>	<p>The Sprint Network Navigator hardware/software will only be able to determine and track the location of the Wireless communication device such as Samsung Galaxy Note 3, Note 4, HTC 8XT etc., if the location flag on the wireless communication device is turned “ON”.</p> <p>The location of the wireless communication device is communicated to the Scout navigation application on the Wireless communication device via communication established by the Sprint’s cell towers between Sprint Network Navigator hardware/software and the wireless communication device</p>
---	--

Element of Claim #1	Corresponding aspects
<p>The said second processor does not determine and communicate the location of the wireless mobile communications device if the preference flags are set to a state that prohibits tracking of the wireless mobile communications device</p>	<p>The Sprint Network Navigator hardware/software will not be able to determine and track the location of the Wireless communication device such as Samsung Galaxy Note 3, Note 4, HTC 8XT etc., if the location flag on the Wireless communication device is turned off.</p>

35. Defendants put the inventions claimed by the '388 Patent into service (i.e., used them); but for Defendants’ actions, the claimed-inventions embodiments involving Defendants’ products and services would never have been put into service. Defendants’ acts complained of herein caused those claimed-invention embodiments as a whole to perform, and Defendants obtaining monetary and commercial benefit from it.

36. Defendants have and continue to induce infringement. Defendants have actively encouraged or instructed others (e.g., its customers), and continues to do so, on how to use its products and services (see charts in paragraph 34), and related services) that use identified U.S.

wireless networks, wireless-network components, and related services that use online and/or off-line navigation such to cause infringement one or more claims of the '388 patent, including—for example—Claims 1-30, literally or under the doctrine of equivalents. Moreover, Defendants have known and should have known of the '388 patent, if not by the issuance of the '284 patent, by at least by the date of the patent's issuance, which followed the date that the patent's underlying application was cited to Defendants by the U.S. Patent and Trademark Office during prosecution of one of Defendants' patent applications, such that Defendants knew and should have known that it was and would be inducing infringement. In addition, Traxcell submitted its Patent Application to Sprint on August 31, 2007. I then received a rejection email on Sept. 7th, 2007, from Steven J. Funk, a patent attorney in Sprint's legal department, who states that "Sprint Nextel has no interest in buying or licensing your patent application". Sprint was first notified about Traxcell's patent application by a USPTO Examiner in about 2005-2006.

37. Defendants have caused and will continue to cause Traxcell damage by infringing (including inducing infringement of) the '388 patent.

PRAYER FOR RELIEF

WHEREFORE, Traxcell respectfully requests that this Court:

- i. enter judgment that Defendants have infringed the '284, '320, '024, and '388 patents;
- ii. award Traxcell damages in an amount sufficient to compensate it for Defendants' infringement of the '284, '320, '024, and '388 patents, in an amount no less than a reasonable royalty, together with prejudgment and post-judgment interest and costs under 35 U.S.C. § 284;

- iii. award Traxcell an accounting for acts of infringement not presented at trial and an award by the Court of additional damage for any such acts of infringement;
- iv. declare this case to be “exceptional” under 35 U.S.C. § 285 and award Traxcell its attorneys’ fees, expenses, and costs incurred in this action;
- v. declare Defendants infringement to be willful and treble the damages, including attorneys’ fees, expenses, and costs incurred in this action and an increase in the damage award pursuant to 35 U.S.C. §284;
- vi. a decree addressing future infringement that either (i) awards a permanent injunction enjoining Defendants and their agents, servants, employees, affiliates, divisions, and subsidiaries, and those in association with Defendants, from infringing the claims of the Patents-in-Suit or (ii) award damages for future infringement in lieu of an injunction, in an amount consistent with the fact that for future infringement the Defendants will be adjudicated infringers of a valid patent, and trebles that amount in view of the fact that the future infringement will be willful as a matter of law; and,
- vii. award Traxcell such other and further relief as this Court deems just and proper.

JURY DEMAND

Traxcell hereby requests a trial by jury on issues so triable by right.

Respectfully submitted,

Ramey & Schwaller, LLP

By: /s/ William P. Ramey, III
William P. Ramey, III
Texas Bar No. 24027643
5020 Montrose Blvd., Suite 750
Houston, Texas 77006
(713) 426-3923 (telephone)
(832) 900-4941 (fax)

wramey@rameyfirm.com

Hicks Thomas, LLP

John B. Thomas (Co-Counsel)
Texas Bar No. 19856150
700 Louisiana Street, Suite 2000
Houston, Texas 77002
(713) 547-9100 (telephone)
(713) 547-9150 (fax)
jthomas@hicks-thomas.com

Attorneys for Traxcell