

**IN THE UNITED STATES DISTRICT COURT
FOR THE DISTRICT OF DELAWARE**

NEXSTEP, INC., a Delaware Corporation,)	
)	
Plaintiff,)	
)	
v.)	C.A. No. 19-
)	
COMCAST CABLE)	JURY TRIAL DEMANDED
COMMUNICATIONS, LLC a Delaware)	
Limited Liability Company.)	
)	
Defendant.)	

COMPLAINT FOR PATENT INFRINGEMENT

Plaintiff NexStep, Inc. (“NexStep”) files this Complaint for Patent Infringement and Demand for Jury Trial against Comcast Cable Communications, LLC (“Defendant” or “Comcast”) and alleges as follows:

THE PARTIES

1. NexStep, Inc. is a Delaware Corporation, with its principal place of business at 4134 Cranford Circle, Suite A, San Jose, California 95124.
2. Comcast Cable Communications, LLC is a Delaware limited liability company and a wholly-owned subsidiary of Comcast Corp., with its principal place of business at One Comcast Center, 1701 JFK Blvd, Philadelphia, PA 19103-2838.
3. On information and belief, Defendant works with Comcast Corp. as well as with Comcast Corp.’s other subsidiaries to provide high-speed Internet, video, voice, and security and automation services to residential customers under the Xfinity brand.

JURISDICTION AND VENUE

4. This action arises under the Patent Act, 35 U.S.C. § 101 *et seq.* This Court has original jurisdiction over this controversy pursuant to 28 U.S.C. §§ 1331 and 1338.

5. Venue is proper in this Court pursuant to 28 U.S.C. §§ 1391(b) and (c) and 1400(b).

6. This Court has personal jurisdiction over Defendant because Defendant is incorporated within this District. Additionally, Defendant maintains substantial operations located in this District, and therefore Defendant's affiliations with this District are so substantial as to render them essentially at home in this District. Defendant operates call centers and Xfinity stores and customer care centers in Delaware, including facilities in Wilmington (5601 Concord Pike, Market Square Shopping Center), Lewes (17601 Coastal Hwy), Newark (132 Christiana Mall) and Dover (1580 DuPont Hwy, Suite 10).

7. Additionally, this Court can further exercise personal jurisdiction over Defendant in this action because Defendant has committed acts of infringement and inducement of infringement in this District, including through selling infringing products and services in this District and because Plaintiff's claims arise out of and relate to Defendant's acts of infringement and inducement of infringement in this District, and because the exercise of jurisdiction by this Court over Defendant in this action would be reasonable. Defendant has more than minimal contacts with this District such that the maintenance of this action within this District would not offend traditional notions of fair play and substantial justice.

NEXSTEP'S INNOVATIONS

8. Dr. Robert Stepanian founded NexStep in 2004. Dr. Stepanian is a pioneer in developing personal computing devices and services to control, combine and integrate telephone and video services, including video conferencing, cable set-top boxes, multi-media PC (e.g., Windows, OS X, or Linux) and other consumer electronic devices from different sources. These technologies can be integrated into handheld devices with fingerprint scanners

and other tools for identification/authorization and personalization. The United States Patent and Trademark Office (“USPTO”) has awarded NexStep, and NexStep continues to prosecute, numerous patents covering innovations in the United States and around the world resulting directly from NexStep’s more than decades-long research and development efforts.

9. NexStep designed, built and demonstrated a series of prototypes and software using its patented technologies.

NEXSTEP’S ASSERTED PATENTS

10. On October 28, 2008, the USPTO issued to Dr. Stepanian U.S. Patent No. 7,444,130 (“the ‘130 Patent”), titled “Tethered Digital Butler Consumer Electronic Device and Method.” A true and correct copy of the ‘130 Patent is attached to this Complaint as **Exhibit 1** and is incorporated by reference herein.

11. On June 2, 2009, the USPTO issued to Dr. Stepanian U.S. Patent No. 7,542,753 (“the ‘753 Patent”), titled “Tethered Digital Butler Consumer Electronic Device and Method.” A true and correct copy of the ‘753 Patent is attached to this Complaint as **Exhibit 2** and is incorporated by reference herein.

12. On April 13, 2010, the USPTO issued to Dr. Stepanian U.S. Patent No. 7,697,669 (“the ‘669 Patent”), titled “Tethered Digital Butler Consumer Electronic Remote Control Device and Method.” A true and correct copy of the ‘669 Patent is attached to this Complaint as **Exhibit 3** and is incorporated by reference herein.

13. On March 15, 2011, the USPTO issued to Dr. Stepanian U.S. Patent No. 7,907,710 (“the ‘710 Patent”), titled “Tethered Digital Butler Consumer Electronic Remote Control Device and Method.” A true and correct copy of the ‘710 Patent is attached to this Complaint as **Exhibit 4** and is incorporated by reference herein.

14. On October 2, 2012, the USPTO issued to Dr. Stepanian U.S. Patent No. 8,280,009 (“the ‘009 Patent”), titled “Consumer Electronic Registration, Control and Support Concierge Device and Method.” A true and correct copy of the ‘009 Patent is attached to this Complaint as **Exhibit 5** and is incorporated by reference herein.

15. On July 23, 2013, the USPTO issued to Dr. Stepanian U.S. Patent No. 8,494,132 (“the ‘132 Patent”), titled “Tethered Digital Butler Consumer Electronic Remote Control Device and Method.” A true and correct copy of the ‘132 Patent is attached to this Complaint as **Exhibit 6** and is incorporated by reference herein.

16. On November 11, 2014, the USPTO issued to Dr. Stepanian U.S. Patent No. 8,885,802 (“the ‘802 Patent”), titled “Tethered Digital Butler Consumer Electronic Remote Control Device and Method.” A true and correct copy of the ‘802 Patent is attached to this Complaint as **Exhibit 7** and is incorporated by reference herein.

17. On April 4, 2017, the USPTO issued to Dr. Stepanian U.S. Patent No. 9,614,964 (“the ‘964 Patent”), titled “Consumer Electronic Registration, Control and Support Concierge Device and Method.” A true and correct copy of the ‘964 Patent is attached to this Complaint as **Exhibit 8** and is incorporated by reference herein.

18. On January 9, 2018, the USPTO issued to Dr. Stepanian U.S. Patent No. 9,866,697 (“the ‘697 Patent”), titled “Consumer Electronic Registration, Control and Support Concierge Device and Method.” A true and correct copy of the ‘697 Patent is attached to this Complaint as **Exhibit 9** and is incorporated by reference herein.

19. The Asserted Patents are generally directed towards novel systems and methods for controlling and integrating a variety devices such as TVs, set-top boxes, DVRs, VoIP (telephone) systems, and home devices (e.g., security cameras, electrical outlets, and

thermostats) using a hand-held device. The Asserted Patents disclose and specifically claim inventive concepts that represent significant improvements over conventional systems by teaching persons skilled in the art how to configure hardware and software resources into a flexible system which offloads some or all of the processing from the remote control device onto a central system (e.g., a master device). The Asserted Patents disclose more than just a simple combination of generic components to perform conventional activities. Indeed, the Asserted Patents claim priority back to applications filed in 2005, about two-years before the world even saw the first iPhone or smartphone app.

NEXSTEP'S NOTICE OF INFRINGEMENT TO DEFENDANT

20. NexStep provided Defendant with notice of its patented inventions on or about June 29, 2007. Under an NDA, Dr. Stepanian met with Comcast's CTO Tony Werner and Bill Warga, Comcast's Director of Digital Technology & Standards, in Denver, Colorado, and provided Defendant an overview of NexStep's patented technology and explained how Comcast could implement the technology in Internet, voice, video and Home services. For example, Dr. Stepanian met with Messrs. Wener and Warga with and provided them with examples of a handheld device for controlling and integrating the various services, and explained how the NexStep technology could enable future Home services and products that were not being offered by Comcast at that time.

21. Comcast's CTO said that he liked NexStep's technology, and requested a further meeting with Dr. Stepanian. At Mr. Werner's request, on or about August 23, 2007, Dr. Stepanian met with Michael Cook, Vice President of Product Management, to further discuss NexStep's inventions. Also at Mr. Werner's request, Dr. Stepanian provided a written summary of NexStep's remote control product and technology.

22. During their 2007 meetings, Dr. Stepanian disclosed that his technology was covered by issued and pending patent applications, which was also stated in the written material that Dr. Stepanian provided to Comcast.

23. Dr. Stepanian followed up in writing with Comcast. Mr. Warga requested that Dr. Stepanian provide him with further written materials to present to Comcast Capital. Dr. Stepanian provided his presentation materials to Mr. Warga as requested. Comcast eventually indicated that it would not work with NexStep because it was purportedly developing its own similar technology. Despite NexStep's best efforts to license its technology to Defendant, Defendant declined to take a license to NexStep's patents.

DEFENDANT'S INFRINGING PRODUCTS AND TECHNOLOGIES

24. Defendant, along with Comcast Corp and its wholly owned subsidiaries, acting on behalf and for the benefit of Defendant, are making, using, selling, offering for sale, and importing into the United States and this District infringing products and services including: Internet, video (TV, including X1 TV), voice, and security services. To operate and benefit from these services, Defendant makes, uses, sells and offers for sale equipment, including modems (including VoIP), gateways/routers, set-top boxes, remote controls, home security sensors and video surveillance cameras, smartphone and tablet devices (Android and Apple) (referred to collectively as "smartphones), and smartphone apps for controlling and integrating these services. Defendant markets and sells these services, equipment and apps under the Xfinity brand name ("Xfinity Services"). See <https://www.xfinity.com/apps>.

25. Defendant installs and sets up Xfinity Services for customers and provides customers with detailed instructions and guidance to ensure that the Xfinity Services function and are properly integrated. Defendant also markets, promotes and instructs customers to

“Bundle” these Xfinity Services. Defendant provides special discounts and incentives when customers “Bundle” TV, Internet, Home Security and Voice services:

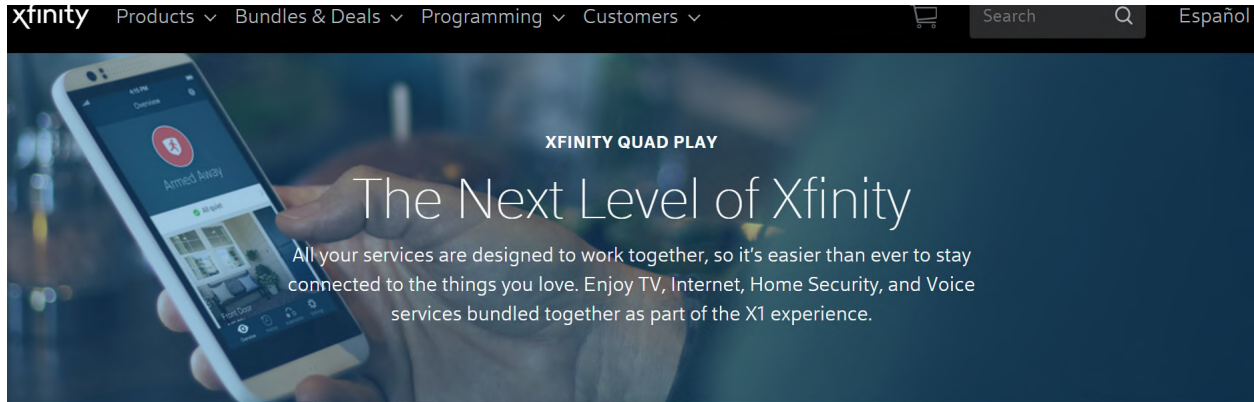

CALL 1-800-215-8490 to get the best deals on TV, Internet, Home Security, and Voice

<https://www.xfinity.com/learn/bundles/quad-play>.

26. Defendant’s Xfinity Services are subject to various terms of use and other contractual restrictions which restrict customers from modifying hardware and software in a manner that is not approved by Defendant. Customers must agree to allow Defendant to enter their property “at which the Service(s) and/or Xfinity Equipment will be provided (the ‘Premises’) at reasonable times, for purposes of installing, configuring, maintaining, inspecting, upgrading, replacing and removing the Service(s) and/or Xfinity Equipment used to receive any of the Service(s).”

<https://www.xfinity.com/Corporate/Customers/Policies/SubscriberAgreement>.

27. Defendant also requires all of its customers to agree to allow Defendant to modify their own equipment (i.e., hardware and software not obtained from Defendant). In particular, Defendant’s terms of service state the following:

“Customer Equipment” means software, hardware or services that you choose to use in connection with the Service(s) and that is not provided or leased by us or our agent. Notwithstanding the last sentence, any equipment purchased by you from us (or our agent) and under an express sale agreement shall constitute “Customer Equipment”.

You agree to allow us and our agents the rights to insert CableCARDS and other hardware in the Customer Equipment, send software and/or “downloads” to the Customer Equipment and install, configure, maintain, inspect and upgrade the Customer Equipment. You warrant you are either the owner of the Customer Equipment or that you have the authority to give us access to the Customer Equipment. If you are not the owner of the Customer Equipment, you are responsible for obtaining any necessary approval from the owner to allow us and our agents access to the Customer Equipment to perform the activities described in this paragraph.

<https://www.xfinity.com/Corporate/Customers/Policies/SubscriberAgreement> (emphasis added).

28. Further, Defendant exercises and retains control over all Xfinity Services including equipment such as hardware and software used to provide Xfinity Services, prohibiting customers from tampering with, altering, modifying or impacting Xfinity Services.

Id.

Xfinity Internet

29. Defendant makes, uses, and sells Internet services to customer. Defendant also sells and leases equipment which it installs and instructs customers on how to install, including the xFi Gateway, modems (with VoIP), and xFi pods (Wi-Fi range extenders), and Xfinity cameras (with recording capability).

Xfinity Video (TV)

30. Defendant offers video (TV) services including its X1 TV services which provide customers with live, video-on-demand (VoD), and streaming services. The X1 video (TV) service provides customers with voice-activated features for controlling TV and integrating other Xfinity Services, including Internet, Home Security and Voice:

Get it all with an X1 TV Box

Welcome to the ultimate entertainment experience for live TV, Netflix, YouTube, and more. Control it all with your X1 Voice Remote. Get our best On Demand. Plus watch anywhere, on any device with the Xfinity Stream app. Unlock all this with an X1 TV Box.



[Discover X1](#)



OR, SKIP THE BOX AND JUST STREAM

Watch on the go and on compatible smart TVs. Enjoy live TV, select On Demand, and basic DVR to record up to two shows at once, and store up to 20 hours.

[Explore Xfinity Stream](#)

X1 Voice Remote and other X1 features available only with X1 TV Box and service.

<https://www.xfinity.com/learn/digital-cable-tv/x1/equipment>.

31. Using Defendant's Xfinity apps, Defendant's video (TV) service provides various features that allow customers to stream video (TV) services at home or on the go, including shows that have been previously recorded (DVR on the go):

X1 VOICE REMOTE

Say it to see it. Instantly.



Simply say what you want to watch into your X1 Voice Remote. We'll show you results from live TV, On Demand, Netflix, and DVR recordings. Plus, quickly access Prime Video, Pandora, and more.



X1 DVR

Take your DVR to go

Watch your recordings from anywhere, even while you're offline. Just download your content to any device and tune in whenever, wherever.

-  Record and watch up to 6 shows at once
-  Never run out of space with 500 GB of storage
-  Take your entire cloud DVR library with you



<https://www.xfinity.com/learn/digital-cable-tv/x1>.

32. Defendant installs and instructs customers on how to install the necessary equipment to use its video (TV) services including the Xfinity X1 set-top boxes, the XR15 and XR11 remote control devices, smartphones (Android and Apple) and apps, including Xfinity My Account, Stream, TV Remote, Home, Connect, xFi, and Authenticator.

Xfinity Voice

33. Defendant provides Xfinity Voice (home telephone) services. Defendant installs and instructs customers on how to install the necessary equipment including wireless gateways and modems with VoIP capability. Defendant leases and sells this equipment to customers:

Rent an Xfinity Wireless Gateway

It gives you clear calls and doubles as a WiFi router for Xfinity Internet.

Purchase your own modem

Prefer to buy your own? Check out our list of compatible modems that work with Xfinity Voice.

[View Compatible Modems](#)

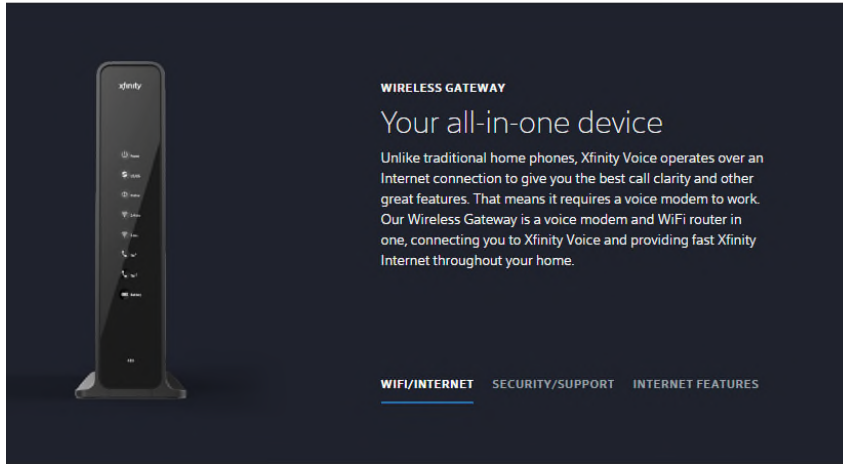

Self-Installation

No technician needed! It's quick and easy to install your Wireless Gateway. Then, you'll be talking to friends and family in no time.



Professional Installation

Prefer not to DIY? We offer convenient, two-hour appointment windows, seven days a week, day or night. Installation charges apply.

<https://www.xfinity.com/learn/home-phone-services/equipment>.

34. Using Xfinity's Connect app, Defendant provides customers with the ability to control and integrate Defendant's Voice service with a smartphone.

Xfinity Home

35. Defendant's Xfinity Home service provides home security systems and includes the Xfinity Home app, simple home control, a touchscreen controller, door/window sensors, motion sensor, wireless keypads, Xfinity cameras, smoke detectors, thermostats, outlets/plugs, and battery and cellular backup systems. <https://www.xfinity.com/learn/xfinity-home-security/devices>.

36. Defendant installs and instructs customers on how to install and integrate its Home services to work with its other Xfinity Services, including, Internet, Video (TV), and Voice services (e.g., controlling video cameras through Defendant's Home app or Defendant's set-top boxes, XR15/XR11 remote control device and gateways):

Our pros make setup and switching a breeze

We can even look at integrating your old system with advanced security technology.

- Get a personal, whole-home assessment
- Customized system recommendations
- And a one-on-one Xfinity Home tutorial

Use of existing equipment subject to condition and type. System takeover currently not available in MA.

<https://www.xfinity.com/learn/xfinity-home-security#7c2f5fa2-b787-4a47-a8e9-d11b51b8acb5>.

XFINITY APPS

37. Defendant makes, uses, and provides (sells and offers for sale) various Xfinity Apps which Defendant designed, owns and controls. Defendant encourages, directs and instructs its customers to use the Xfinity Apps to control and use Defendant's Internet, video (TV), voice, and Home services. <https://www.xfinity.com/apps>.

38. Defendant's My Account App provides the following functions and features, and has been downloaded onto millions of devices:

The hassle-free way to manage your Xfinity account anywhere, anytime – with no call needed. It's easy and fast to access and personalize your WiFi name and password, check for service outages, troubleshoot or refresh your equipment, view and pay your bill, find out your tech's arrival time, view your channel lineup and update your account whenever and wherever you want.

Billing

- Sign up for paperless billing with EcoBill to receive monthly statements to your email inbox instead of your mailbox

Manage Your Account Information

- View your channel lineup
- View and edit your account information, such as your contact phone number, password and email address
- Look up or change your Xfinity username and password
- View information about your internet usage
- View your Comcast Digital Voice number

Setup and Troubleshooting:

- View or personalize your WiFi name and password
- Refresh your X1 TV box and troubleshoot your Xfinity devices
- Check the connection status of your devices and get updates on service outages
- Set up your remote to control all of your entertainment

Appointments

- Check the status, reschedule or cancel your service appointment
- Find out your tech's estimated time of arrival

Contact Us

- Request a call back from an Xfinity representative
- Find the nearest Comcast Service Center

<https://play.google.com/store/apps/details?id=com.comcast.cvs.android>.

39. Defendant's Stream App provides the following functions and features, and has been downloaded onto millions of devices:

Only Xfinity gives you more to stream on any screen. Watch live TV and Xfinity On Demand on any device at home or on the go. If you're an X1 or Instant TV Cloud DVR customer, you can also stream or download your Cloud DVR recordings to your device and watch anywhere.

Key Features:

- Filter by Available Out of Home to watch more than 200 channels of Live TV on the go from any available WiFi or cellular connection in the U.S.
- Choose from tens of thousands of TV shows and movies available for streaming On Demand. Filter by Available for Download to see programs available for offline viewing.
- X1 and Instant TV Cloud DVR customers can watch saved recordings from anywhere in the U.S. with an internet connection. Once downloaded, videos can be viewed offline—anytime, anywhere (including planes, trains, and automobiles).
- Favorites on X1 now sync with the Xfinity Stream app. Easily track the channels, TV shows, movies, & sports teams you love.
- If you have previously made a movie purchase On Demand, you can take these purchases with you wherever you go, right from the app!
- Trying to find a show or movie? Use the search function to see if it is available On Demand or airing soon.

Exclusive In-Home Features:

- Watch live TV streams from your entire channel lineup when on your in-home Xfinity network.
- Choose from Xfinity full Video On Demand library, filtered to show only the content included in your subscription at no extra charge.
- Stream rented TV shows and movies right to the app during the rental period.

https://play.google.com/store/apps/details?id=com.xfinity.cloudtvr&referrer=utm_source%3Dother_xfinity_web.

40. Defendant's xFi App provides the following functions and features, and has been downloaded onto millions of devices:

The Xfinity xFi app will change the way you WiFi with a whole new way to personalize and control your home network. With xFi, you can set up your home WiFi and be online in minutes, find your WiFi password, know who's online, troubleshoot issues, and even pause WiFi access during dinner time.

Xfinity xFi is available to Xfinity Internet customers with a compatible Xfinity Gateway.

Key Features:

- Simple, easy setup of your Xfinity Internet service and home WiFi – no Comcast technician required.
- View and change your WiFi name and password.
- See what devices are connected to your home network and give them nicknames for easy reference.
- Create profiles so you can assign devices to your family members.
- Set parental controls and bedtime schedules so your kids see the right content and sleep when they should.
- Pause WiFi access for any device or profile.
- Troubleshoot issues on your own without calling customer service.
- Manage advanced network settings to customize your home network.
- Add xFi Pods to help eliminate deadspots for more consistent, reliable WiFi coverage throughout your home.

<https://play.google.com/store/apps/details?id=com.xfinity.digitalhome>.

41. Defendant's Home App provides the following functions and features, and has been downloaded onto millions of devices:

The Xfinity Home app lets you stay connected to your home even when you're on the go. Arm and disarm your system, create automated rules, access video to see when the kids get home, or turn on the lights and adjust the temperature before you walk through the door. It's quick, easy and always available on your smartphone or tablet.

FEATURES

- Remote arm and disarm
- Real-time text and email alerts when alarms are triggered and motion is detected*
- Remote video monitoring*
- Lighting and thermostat control*

WORKS WITH XFINITY COMPATIBLE DEVICES*

- Thermostats: Nest Learning Thermostat, ecobee, Carrier Cor, Zen
- Garage Door Openers: Chamberlain or LiftMaster MyQ Garage Door Opener
- Lighting: Philips Hue Lights, Lutron Caséta Wireless Light Switches and Dimmers, Sengled Element Touch Bulb, GE (Jasco) Wireless Light Switches and Dimmers, LIFX Lights
- Locks: August Smart Locks, Kwikset SmartCode Door Locks

<https://play.google.com/store/apps/details?id=com.comcast>.

42. Defendant's Connect App provides the following functions and features, and has been downloaded onto millions of devices:

The Xfinity Connect app extends your Xfinity services onto your mobile devices.

Key Features:

- Access your Comcast.net email.
- Never miss a phone call. Answer calls made to your Xfinity Voice home phone.
- With Voice2Go you can make outbound calls from your Xfinity Voice phone numbers.
- Access your home phone voicemails, voicemail transcripts, call logs, and call forwarding settings.
- Send and receive free text messages to more than 40 countries.
- Manage your Xfinity contacts.
- View Caller ID (only available on specific devices).
- Manage your Xfinity Connect account.

Requirements:

- An active subscription to Xfinity Voice or Xfinity Internet.
- An Xfinity login or a Comcast.net email address.
- Voice2Go requires an Xfinity Voice Residential Unlimited subscription.
- Text Messaging requires an Xfinity Voice Residential Unlimited subscription.

<https://play.google.com/store/apps/details?id=net.comcast.ottclient>.

43. Defendant's TV Remote App provides the following functions and features, and has been downloaded onto millions of devices:

Exclusive Features for X1 Customers:

- Say it and see it with the new X1 voice remote feature. Use voice commands to change channels, find shows, get recommendations, launch apps, and more!
- Conveniently change channels on your TV using the channel number keypad.
- Use the directional (up, down, left, right) pad on the app for on-screen navigation, just like you would on your X1 remote.

Use your smartphone or tablet as a remote control. Change channels, browse XFINITY On Demand and TV listings. If you're an X1 customer, you can now bring the power of X1 voice remote to your mobile device.

Key Features:

- Tune to your preferred channels on your TV from the Listings view, and use Filters to narrow down listings by categories such as Sports, Kids, High Definition, Closed Captioning, and more.
- Browse the XFINITY On Demand library featuring thousands of TV shows and movies, and launch your selection onto your TV from the app.
- Use the Search feature to find TV shows, movies, or channels.
- Rename the cable boxes in your home for easier identification.

Features for DVR Customers:

- Launch existing recordings onto your TV right from the app and delete them when you're finished.
- View scheduled recordings.

<https://play.google.com/store/apps/details?id=com.xfinity.tv>.

44. Defendant's Authenticator App provides the following functions and features:

The Xfinity Authenticator app helps keep your information safe, even if someone has gotten a hold of your username and password. This extra layer of security helps prevent anyone who does not have your permission from signing in to your Xfinity account. Authenticator works with our Two-Step verification, so it's easy to approve sign-in requests with Fingerprint.

Xfinity Authenticator is available to all Xfinity customers.

Key Features:

- Receive a push notification when unrecognized devices attempt to sign in to your account
- Easily approve sign in requests with Touch or Face ID
- Verify your mobile phone number and personal email address
- Securely create verification codes

<https://play.google.com/store/apps/details?id=com.comcast.xfinityauthenticator>.

DEFENDANT'S WILLFUL INFRINGEMENT OF NEXSTEP PATENTS

45. Defendant has infringed and continues to infringe, the '130, '753, '669, '710, '009, '132, '802, '964, and '697 Patents (collectively, the "Asserted Patents") in this Judicial

District and elsewhere in the United States by making, using, importing, selling, and offering for sale the Defendant's Xfinity Services: Internet, video(TV), voice, home, and mobile (collectively, the "Accused Products").

46. In addition to directly infringing the Asserted Patents under 35 U.S.C. § 271(a), either literally, under the doctrine of equivalents, or both, Defendant indirectly infringes the Asserted Patents by instructing, directing, and requiring others, including its customers, purchasers, users, and developers, to combine or perform all or some of the steps of the method claims, either literally or under the doctrine of equivalents.

COUNT I

(Direct Infringement of the '802 Patent pursuant to 35 U.S.C. § 271(a))

47. NexStep repeats, realleges, and incorporates by reference, as if fully set forth herein, the allegations of the preceding paragraphs, as set forth above.

48. Defendant infringes at least Claim 1 of the '802 Patent in violation of 35 U.S.C. § 271(a).

49. Defendant's infringement is based upon literal infringement or, in the alternative, infringement under the doctrine of equivalents.

50. Defendant's acts of making, using, importing, selling, and offering for sale infringing products and services were without the permission, consent, authorization, or license of NexStep.

51. Defendant's infringement includes, the manufacture, use, sale, importation and offer for sale of Defendant's Xfinity Services, including equipment to make and use the Xfinity Services (collectively, the "'802 Accused Products").

52. The '802 Accused Products infringe the '802 Patent because Defendant makes, uses, and sells systems with a remote control device with audio inputs (e.g., a microphone),

including navigation controls, audio processors, and Bluetooth communications, hardware stack running on the hardware resources for exchanging packets with set-top boxes and gateways, and a hardware stack for exchanging packets with a signal source.

53. To the extent the '802 Accused Products include hardware or software owned by third parties, the '802 Accused Products still infringe the '802 Patent because Defendant is vicariously liable for the manufacture and use of the patented system by controlling the entire system and deriving a benefit from the use of every element of the entire system. Similarly, to the extent Defendant's third parties (e.g., customers) form the '802 Accused Products or use their own equipment to form the '802 Accused Products, Defendant still infringes the '802 Patent because third parties' beneficial use of the '802 Accused Products is conditioned on combining the components in an infringing manner.

54. Defendant sells smartphones, software, and other equipment with instructions and users guides, to use its Xfinity Services, including Xfinity Apps.

<https://www.xfinity.com/mobile/shop?category=device>.

55. The '802 Accused Products, including XR11, X15, and Xfinity Apps such as TV Remote, Stream, Connect, xFi, and Home apps, infringe the '802 Patent because they provide systems and methods that allow customers to control set-top boxes, DVRs, VoD, and to operate home security devices, among other features provided by Xfinity Apps described above.

56. The XR11/XR15 remote controls and smartphone (e.g., Galaxy S9) running Xfinity Apps include microphones for receiving audio input and Wi-Fi wireless link transceivers for sending/receiving data between the set-top boxes working with gateways and Defendant's Cloud. By pressing it, one can access a plurality of inputs and outputs, including a

microphone and an audio output transmitted to the set-top boxes. Additionally, the XR11/XR15 remote controls and smartphones include a speaker for an audible audio output (e.g., shown in the red boxes below for the XR15 and labeled in the Galaxy S9 below).

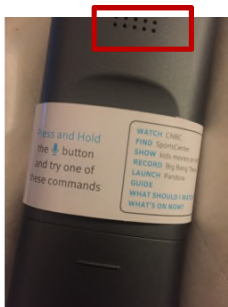
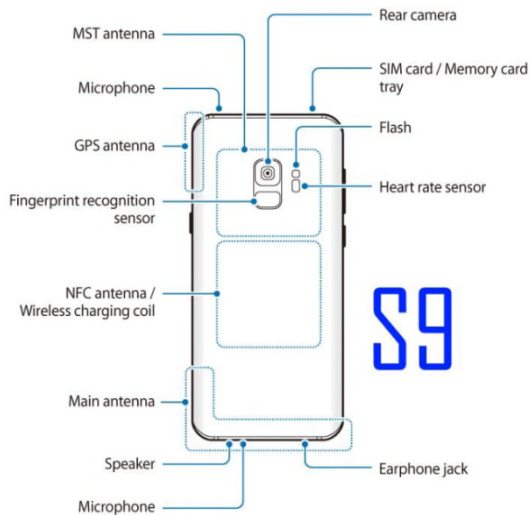

<https://www.xfinity.com/support/remotes/>; **Ex. 11, Ex. 17.**

57. The XR11/XR15 remote controls and smartphones (e.g., Galaxy S9) running Xfinity Apps include hardware resources (e.g., processor and firmware) coupled to the wireless link transceiver, microphone (slaved audio input) and keypad (navigation control) in order to function.

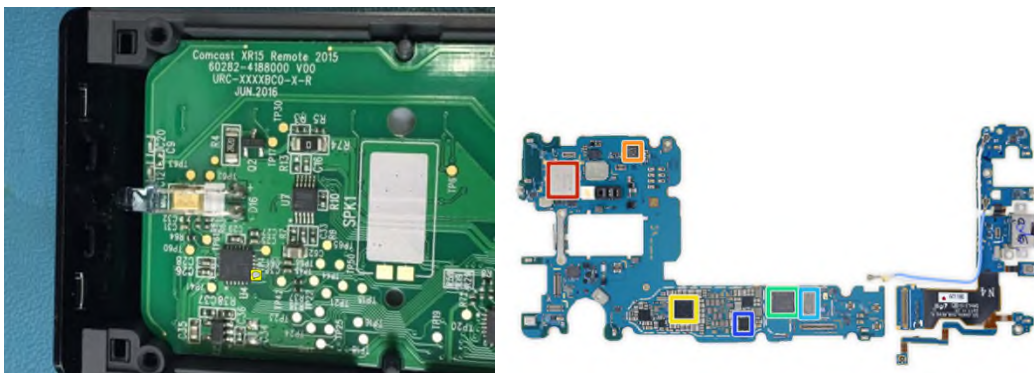

Ex. 18; Ex. 10.

58. The XR11/XR15 remote controls and smartphones (e.g., Galaxy S9) running Xfinity Apps include Bluetooth transmitter/receivers (e.g., using TI's ZigBee® RF4CE and Maruta KM7N07016 Wi-Fi/Bluetooth module) for encoding and sending audio input from the microphone. They meet the recited claim language because they have a stack running on the hardware resources (e.g., microcontroller) and exchange packets (e.g., using a Bluetooth transceiver) with the set-top boxes and gateways working with Defendant's Cloud for transcoding, DRM and packaging data. **Ex. 16; Ex. 10.**

59. The XR11/XR15 remote controls and smartphone (e.g., Galaxy S9) running Xfinity Apps use the hardware resources (e.g., A/D converters and codecs) coupled to the microphone to encode audio/voice into packets and then sends the data to the set-top boxes

60. The gateways and set-top boxes working with Defendant's Cloud can transcode the audio input into VoIP and then search Defendant's Cloud for content and perform specific commands.

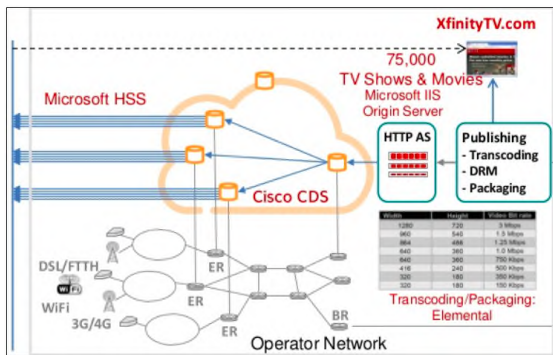

Speak up. Cheer loudly for your favorite team.

In addition to our apps, you can use the power of your voice and the X1 Voice Remote to search across events by pressing the microphone button and speaking your instructions aloud. Did you know there are over 1,500 Olympic-specific voice commands? We went for the gold.

Here are the most common commands that you should know about this February:

Voice Command	Action
"Olympics" or "Pyeongchang Games"	Navigates to Olympics home screen on X1.
"What sports are competing today?"	Navigates to Olympics Daily Summary screen.
"Bobsleigh results"	View in-depth result screen for a specific event.
"Show me curling."	Displays summary card for your desired sport.
"Italy figure skating."	Shows sport summary by country.
"Show me medals"	Opens the complete medal count by country.

Ex. 16 at p. 24; <https://www.xfinity.com/hub/tv-video/x1-voice-remote-commands-winter-olympics>.

61. Defendant’s infringement of the ‘802 Patent injured and is injuring NexStep in an amount to be proven at trial, but not less than a reasonable royalty.

62. Defendant has been long-aware of NexStep’s patented technology, and continues its unauthorized infringing activity despite this knowledge. As discussed above, NexStep actively and diligently attempted to engage in good faith negotiations with Defendant. After being shown NexStep’s patented technology in 2007, including the technology covered in the ‘802 Patent, on information and belief, Defendant copied this technology and made no effort to avoid infringement when it later launched its Xfinity Internet, video (TV), and voice services on or about 2010. Instead, Defendant continued to incorporate NexStep’s technology into additional products, such as those identified in this complaint, including remote control devices with voice activated controls. All of these actions demonstrate Defendant’s willful, blatant and egregious disregard for NexStep’s patent rights.

63. Despite its knowledge of NexStep’s patented technology and its specific knowledge of its own infringement, Defendant continued to sell the Accused Products in complete and reckless disregard of NexStep’s patent rights. As such, Defendant acted recklessly, willfully, wantonly, and deliberately engaged in acts of infringement of the ‘802

Patent, justifying an award to NexStep of increased damages under 35 U.S.C. § 284, and attorneys' fees and costs incurred under 35 U.S.C. § 285.

COUNT II

(Indirect Infringement of the '802 Patent pursuant to 35 U.S.C. § 271(b))

64. NexStep repeats, realleges, and incorporates by reference, as if fully set forth herein, the allegations of the preceding paragraphs, as set forth above.

65. As discussed above, Defendant knew about NexStep's patented technology, including the '802 Patent, by at least 2007.

66. In addition to directly infringing the '802 Patent, Defendant knew or was willfully blind to the fact that it was inducing infringement of at least Claim 1 the '802 Patent under 35 U.S.C. § 271(b) by instructing, directing and requiring third parties (e.g., customers) to use and combine the components of the system claims of the '802 Patent, either literally or under the doctrine of equivalents.

67. Defendant knowingly and actively aided and abetted the direct infringement of the '802 Patent by instructing and encouraging its customers and developers to use the '802 Accused Products. Such instructions and encouragement included advising third parties to use the '802 Accused Products in an infringing manner, providing a mechanism through which third parties may infringe the '802 Patent, advertising and promoting the use of the '802 Accused Products in an infringing manner, and distributing guidelines and instructions to third parties on how to use the '802 Accused Products in an infringing manner.

COUNT III

(Direct Infringement of the '753 Patent pursuant to 35 U.S.C. § 271(a))

68. NexStep repeats, realleges, and incorporates by reference, as if fully set forth herein, the allegations of the preceding paragraphs, as set forth above.

69. Defendant infringes at least Claim 1 of the '753 Patent in violation of 35 U.S.C. § 271(a).

70. Defendant's infringement is based upon literal infringement or, in the alternative, infringement under the doctrine of equivalents.

71. Defendant's acts of making, using, importing, selling, and offering for sale infringing products and services were without the permission, consent, authorization, or license of NexStep.

72. Defendant's infringement includes, the manufacture, use, sale, importation and offer for sale of Defendant's Xfinity Services, including equipment to make and use the Xfinity Services (collectively, the "753 Accused Products").

73. The '753 Accused Products infringe the '753 Patent because Defendant makes, uses, and sells systems with a remote control device with audio reproduction, including audio inputs and outputs, a microphone, touch screen navigation controls and keyboards, audio processors, and Wi-Fi or Bluetooth communications, and include a stack running on the hardware resources for exchanging packets with set-top boxes and gateways.

74. To the extent the '753 Accused Products include hardware or software owned by third parties, the '753 Accused Products still infringe the '753 Patent because Defendant is vicariously liable for the manufacture and use of the patented system by controlling the entire system and deriving a benefit from the use of every element of the entire system. Similarly, to the extent Defendant's third parties (e.g., customers) form the '753 Accused Products or use their own equipment to form the '753 Accused Products, Defendant still infringes the '753 Patent because Defendant conditions the third parties' beneficial use of the '753 Accused

Products on combining the components in an infringing manner, and because Defendant directs, masterminds and controls their use of the ‘753 Accused Products.

75. Defendant sells smartphones, software, and other equipment with instructions and users guides, to use its Xfinity Services, including Xfinity Apps.

<https://www.xfinity.com/mobile/shop?category=device>.

76. The ‘753 Accused Products, including Xfinity Apps such as TV Remote, Stream, Connect, xFi, and Home apps, infringe the ‘753 Patent because they provide systems and methods that allow customers to control set-top boxes, DVRs, VoD, and operate home security devices, among other features provided by Xfinity Apps described above.

77. Defendant sells a variety of Smartphones, such as the Galaxy S9 which is used as a representative example herein. The Galaxy S9 sold by Defendant comprises a radio, which is a Qualcomm SDR 845 RF Transceiver shown below in the green box:

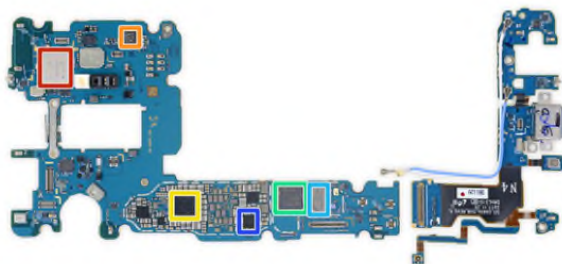

Ex. 10.

78. The Galaxy S9 sold by Defendant includes a plurality of slaved audio inputs and outputs, i.e., a microphone, a transceiver for translating audio data, plurality of antennas as shown below:

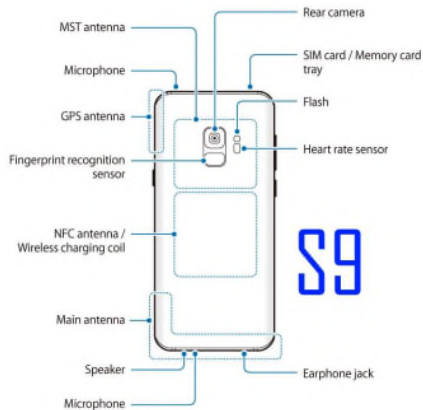

Ex. 11.

79. Smartphones, such as the Galaxy S9, sold by Defendant running the Xfinity Apps use the directional (up, down, left, right) pad on the app for on-screen navigation:

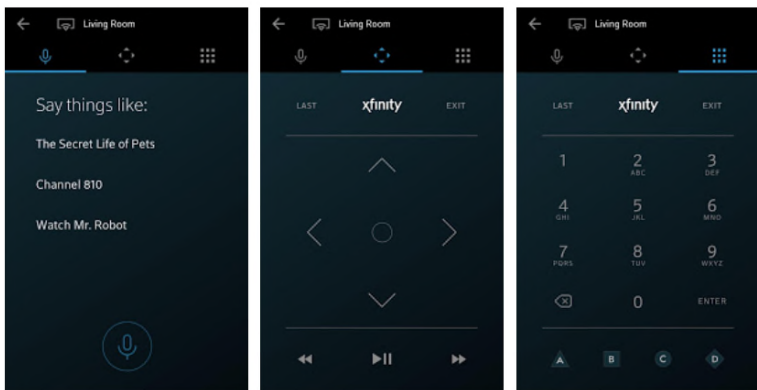

<https://play.google.com/store/apps/details?id=com.xfinity.tv&hl=en> US.

80. Smartphones sold by Defendant running the Xfinity Apps couples the hardware resources with the wireless link transceiver, the slaved audio input and the navigation control. The Galaxy S9’s Murata Bluetooth module includes the wireless link transceiver, and the microphone that acts as slaved audio input, coupled together with the touchscreen circular ring that acts as the navigation control. See **Ex. 10**.

81. The Galaxy S9 sold by Defendant running the Xfinity Apps uses Qualcomm SDR 845 RF Transceiver for transmitting packets. Further, the Murata Bluetooth chipset along with Qualcomm microcontroller chipset (i.e., stack), both present on Galaxy S9, run on the remote

control motherboard (i.e., hardware resources) and exchange packets with the Bluetooth chipset present in the set-top boxes and Wi-Fi receivers in the gateways. **Ex. 12.**

82. Smartphones, such as the Galaxy S9, sold by Defendant running the Xfinity Apps include a coprocessor, which converts/encodes the audio and is capable of utilizing assisted A2DP, to process the audio into a remote control audio format. Assisted A2DP enables wireless transmission of audio between two devices (as shown below).

6.4.4.2 Assisted A2DP

The advanced audio distribution profile (A2DP) enables wireless transmission of high-quality mono or stereo audio between two devices. A2DP defines two roles:

- A2DP source is the transmitter of the audio stream.
- A2DP sink is the receiver of the audio stream.

Ex. 13.

83. The Galaxy S9 sold by Defendant running the Xfinity Apps sends and receives audio packets in the remote control device format from the set-top boxes working with gateways and servers. Xfinity TV set-top boxes working with gateways and servers transcode input from the slaved audio input from the remote control device format (e.g., transcoding input and utilizing Comcast TV Remote and Stream Apps for mobile phones via Defendant's Cloud).

84. Defendant's infringement of the '753 Patent injured and is injuring NexStep in an amount to be proven at trial, but not less than a reasonable royalty.

85. Defendant has been long-aware of NexStep's patented technology, and continues its unauthorized infringing activity despite this knowledge. As discussed above, NexStep actively and diligently attempted to engage in good faith negotiations with Defendant. After being shown NexStep's patented technology in 2007, including the technology covered in the '753 Patent, on information and belief, Defendant copied this technology and made no effort to avoid infringement when it later launched its Xfinity Internet, video (TV), and voice services

on or about 2010. Instead, Defendant continued to incorporate NexStep's technology into additional products, such as those identified in this complaint, including remote control devices with voice activated controls. All of these actions demonstrate Defendant's willful, blatant and egregious disregard for NexStep's patent rights.

86. Despite its knowledge of NexStep's patented technology and its specific knowledge of its own infringement, Defendant continued to sell the Accused Products in complete and reckless disregard of NexStep's patent rights. As such, Defendant acted recklessly, willfully, wantonly, and deliberately engaged in acts of infringement of the '753 Patent, justifying an award to NexStep of increased damages under 35 U.S.C. § 284, and attorneys' fees and costs incurred under 35 U.S.C. § 285.

COUNT IV

(Indirect Infringement of the '753 Patent pursuant to 35 U.S.C. § 271(b))

87. NexStep repeats, realleges, and incorporates by reference, as if fully set forth herein, the allegations of the preceding paragraphs, as set forth above.

88. As discussed above, Defendant knew about NexStep's patented technology, including the '753 Patent, by at least 2007.

89. In addition to directly infringing the '753 Patent, Defendant knew or was willfully blind to the fact that it was inducing infringement of at least Claim 1 the '753 Patent under 35 U.S.C. § 271(b) by instructing, directing and requiring third parties (e.g., customers) to use and combine the components of the system claims of the '753 Patent, either literally or under the doctrine of equivalents.

90. Defendant knowingly and actively aided and abetted the direct infringement of the '753 Patent by instructing and encouraging its customers and developers to use the '753 Accused Products. Such instructions and encouragement included advising third parties to

use the ‘753 Accused Products in an infringing manner, providing a mechanism through which third parties may infringe the ‘753 Patent, advertising and promoting the use of the ‘753 Accused Products in an infringing manner, and distributing guidelines and instructions to third parties on how to use the ‘753 Accused Products in an infringing manner.

COUNT V

(Direct Infringement of the ‘669 Patent pursuant to 35 U.S.C. § 271(a))

91. NexStep repeats, realleges, and incorporates by reference, as if fully set forth herein, the allegations of the preceding paragraphs, as set forth above.

92. Defendant has infringed and continues to infringe at least Claim 27 of the ‘669 Patent in violation of 35 U.S.C. § 271(a).

93. Xfinity TV set-top boxes working with servers transcode input from the slaved audio input to VoIP from the remote control device format (e.g., transcoding input and utilizing Comcast TV Remote and Stream Apps for mobile phones via servers).

94. Defendant’s infringement is based upon literal infringement or, in the alternative, infringement under the doctrine of equivalents.

95. Defendant’s acts of making, using, importing, selling, and offering for sale infringing products and services have been without the permission, consent, authorization or license of NexStep.

96. Defendant’s infringement includes the manufacture, use, sale, importation and offer for sale of Defendant’s Xfinity Services, including equipment to make and use the Xfinity Services (collectively, the “‘669 Accused Products”).

97. The ‘669 Accused Products infringe the ‘669 Patent because Defendant makes, uses, and sells remote controls with at least, the following features: audio inputs and outputs, including DRM logic, a microphone, a touch screen with navigation controls and keyboards,

audio processors, Wi-Fi and Bluetooth communications, a stack running on the hardware resources for exchanging packets with set-top boxes and VoIP enabled gateways.

98. To the extent the '669 Accused Products include hardware or software owned by third parties, the '669 Accused Products still infringe the '669 Patent because Defendant is vicariously liable for the manufacture and use of the patented system by controlling the entire system and deriving a benefit from the use of every element of the entire system. Similarly, to the extent Defendant's third parties (e.g., customers) form the '669 Accused Products or use their own equipment to form the '669 Accused Products, Defendant still infringes the '669 Patent because Defendant conditions the third parties' beneficial use of the '669 Accused Products on combining the components in an infringing manner, and because Defendant directs, masterminds and controls their use of the '669 Accused Products.

99. Defendant sells smartphones, software, and other equipment with instructions and users guides, to use its Xfinity Services, including Xfinity Apps.

<https://www.xfinity.com/mobile/shop?category=device>.

100. The '669 Accused Products, including Xfinity Apps such as TV Remote, Stream, Connect, xFi, and Home apps, infringe the '669 Patent because they provide systems and methods that allow customers to control set-top boxes, DVRs, VoD, and operate home security devices, among other features provided by Xfinity Apps described above.

101. Smartphones sold by Defendant running the Xfinity Apps (e.g., iPhone XR) are remote control devices that include a button with an image/icon of a microphone. When the Microphone button is pressed, it controls the built-in microphone to accept voice (i.e., audio) input.

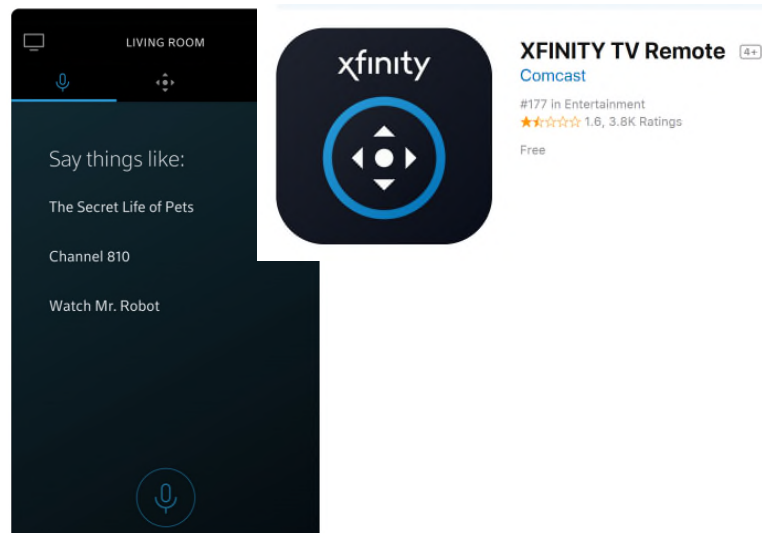

<https://itunes.apple.com/us/app/xfinity-tv-remote/id401629893?mt=8>.

102. Smartphones, such as the iPhone XR, sold by Defendant and running the Xfinity Apps have Wi-Fi and Bluetooth wireless link transceivers, include cameras, microphones and speakers as shown below

- With the logic board out, we get our first look at the onboard silicon:
- Apple APL1W81 A12 Bionic SoC, layered over Micron D9VZV MT53D384M64D45B-046 XT:E 3 GB LPDDR4x SDRAM
- Apple/USI 339S00580 (likely a WiFi/Bluetooth module, similar to what's found in the XS)
- NXP 100VB27 NFC controller
- 3x Apple 338S00411 audio amplifiers
- Skyworks 203-15 G67407 1838 (likely a power amplification module)
- Cypress CPD2 USB power delivery IC
- 76018 119G1



Ex. 14.

103. Smartphones, such as the iPhone XR, sold by Defendant and running the Xfinity Apps include audio codecs (light blue box) for processing the audio inputs and outputs and provides a touchscreen display for navigating and controlling the device:

- More chips on the back side of the logic board. Show us your identification, please...
- Toshiba TSB3243VC0428CHNA1 64 GB flash storage
- Intel 9955 (likely the XMM7560 LTE Advanced Pro 4G LTE baseband processor), 5762 RF transceiver, and 5829
- Apple 338S00383-A0, 338S00375-A1 power management IC's (possibly from Dialog Systems)
- Texas Instruments SN2600B1 battery charging IC
- Apple 338S00248 audio codec (possibly from Cirrus Logic)
- Skyworks 13768 front end module
- Broadcom 59355A2IUB4G (likely a variation of the [BCM59350](#) wireless power receiver chip)

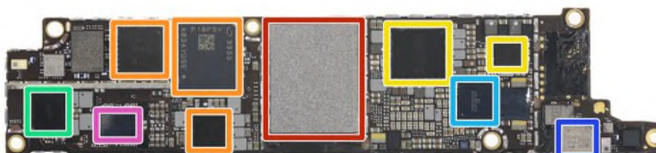

Ex. 14

104. Smartphones, such as the iPhone XR, sold by Defendant and running the Xfinity Apps include hardware resources coupled between the wireless link transceiver, including a Bluetooth wireless transceiver for connecting wireless headphones, and the DRM port, slaved audio input (streaming music/video and microphone), and navigation controls (e.g., touch screen processor). A smartphone has an AAC DRM compliant audio codec, amplifier, and Bluetooth processor.

Bluetooth audio devices become more and more popular today – stereo headsets and headphones, wireless audio transmitters/receivers, cell phones and mp3 players with Bluetooth Advanced Audio Distribution Profile (A2DP). Headphones and headsets seems benefit the most from Bluetooth (BT) audio. To be honest first BT stereo headphones were of poor sound quality – dirty sound with annoying “hiss” on background. Definitely that was not because of BT technology limitations but mainly because of poor implementation of the latter and slipshod design of analog audio circuits. The situation changes slowly but steadily. For example modern BT stereo headphones DR-BT50 from Sony can successfully compete with ordinary wired ones already. Their sound quality will be sufficient for vast majority of portable player owners for sure. In no doubt if manufacturers decide they could produce perfectly sounding BT headphones for demanding listeners as well. In that case the way digital audio transmits over BT protocol is a bottleneck in the whole audio transmission chain.

As the data channel used by A2DP is only 721 kbps wide some data reduction scheme is required. While BT specifications allow using of different audio codecs (mp2, mp3, wma, aac and even atrac) the only mandatory codec for all BT audio devices is subband codec (SBC). In fact many BT headphones (including above mentioned DR-BT50) already support mp3 codec but in real life it remains unused. Obviously it was made for the sake of compatibility but the same time portable devices could benefit from direct streaming of mp3 files through BT interface saving both audio quality and battery life. However in today's practice all high quality audio still transfers over A2DP by means of SBC codec.

SBC codec appeared in SoundExpert ratings more than two years ago (see [320+ kbit/s section](#)). The bitrate used for testing (372 kbps) showed good potential of this compression scheme but it's clear now that above setting doesn't reflect real-life scenario of the codec use. Let's look for example at these two major BT applications:

Toshiba Bluetooth stack for Windows (6.10) has three quality modes for SBC codec

- High Quality – 328 kbps
- Middle Quality – 229 kbps
- Low Quality – 201 kbps

IVT Corp. Bluesoleil (5.0.5) has two quality modes: High and Middle. It's not mentioned what bitrates are used but the application has special “Status Window” available for any BT connection. Among other information it shows amount of bytes sent to and received from connected device. Simple calculations reveal the same bit rates for High and Middle quality modes – 328 kbps and 229 kbps. As Bluesoleil is capable of both sending and receiving A2DP audio data its status window helps to discover actual bitrates used by any connected BT device. For example cell phone Nokia 6500 classic also sends music to BT interface at 229 kbps and the bitrate can't be altered in phone's settings (may be some advanced music phones and players have such possibility, though).

Such unanimity in choosing SBC codec settings is not surprising. Bluetooth Special Interest Group (SIG) recommends using of those settings in A2DP specifications (A2DP_SPEC, Revision V12):

Ex. 15.

105. Smartphones, such as the iPhone XR, sold by Defendant and running the Xfinity Apps include a stack running on the hardware resources to exchange packets between audio processors and main processors and set-top boxes/DVRs (e.g., where the main processor or set-top boxes/gateways can perform functions of a master device via a stack, such as Wi-Fi and Bluetooth protocol stacks or network stacks, for implementing communication protocols between the set-top boxes and gateways and the remote controls) running on the hardware resources. A smartphone using the Xfinity Apps can stream a customer's DVR recordings to a smartphone:

Stream Live TV and DVR Recordings With Your Xfinity Stream Portal

This article provides information on streaming live TV and DVR recordings using the Xfinity Stream portal.

Turn any computer into a personal TV screen with the Xfinity Stream portal (www.xfinity.com/stream)! Stream live TV, watch Xfinity On Demand and access your DVR recordings on your computer through any Internet connection!

Note: Only Xfinity X1 Cloud DVR customers can access and delete recordings with the Xfinity Stream portal.

<https://www.xfinity.com/support/articles/xfinity-tv-website-live-tv-and-dvr-streaming>.

106. Smartphones, such as the iPhone XR, sold by Defendant and running the Xfinity Apps depend on the set-top boxes/gateways to transcode audio streams from one or more media servers into a remote control format such as Bluetooth or Wi-Fi.

107. Smartphones sold by Defendant and running the Xfinity Apps include decoder logic coupled to the stack to receive the packets processed by the master device, and adapted to decode the remote control device format into signals to drive the slaved output. The Bluetooth and Wi-Fi stream is decoded and then the Xfinity App further converts the audio stream into signals to drive the slaved audio output (which may be speakers or may be reconverted for transmission to Bluetooth compatible speakers). The coprocessor, which converts and encodes audio, and is capable of utilizing assisted A2DP, can process the audio into a remote control audio format. Assisted A2DP enables wireless transmission of audio between two devices. The audio input is then converted into a remote-control audio format that can be processed by the Xfinity set-top boxes/gateways and Xfinity Defendant's Cloud.

108. Smartphones sold by Defendant running the Xfinity Apps include navigation controls built into the App such as directional arrows and select/enter buttons (as shown below):

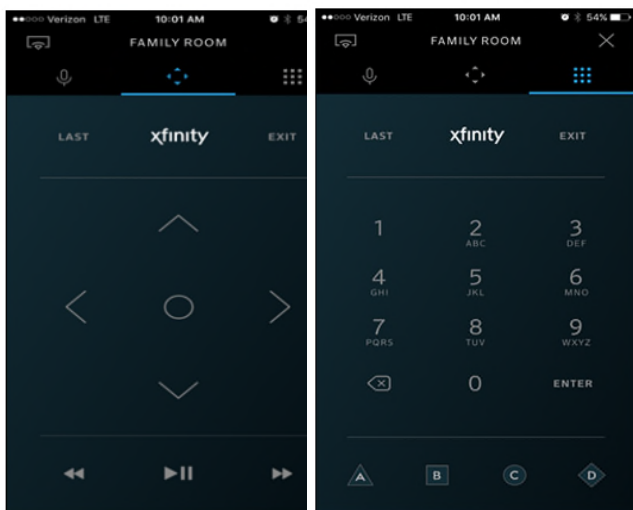

<https://www.xfinity.com/support/articles/setting-up-the-cable-tv-app>.

109. Smartphones, such as the iPhone XR, sold by Defendant and running the Xfinity Apps use the set-top boxes/gateways to respond to the control signals to change the audio stream delivered in the packets and to direct the audio packets sent by the remote control for appropriate processing on the master device, including transcoding input from and output to the slaved microphone and audio output between VoIP and the remote control device format.

X1 Customers

- It's now even easier to find TV shows and movies using the Xfinity TV Remote app! X1 customers can tap the **Microphone** icon and say things like, "The Secret Life of Pets," and "Channel 810." However, please note that this functionality only works on Xfinity X1 TV Boxes (RNG150 devices are excluded) and requires Apple devices have iOS 10 or higher and Android devices have Jellybean or higher.

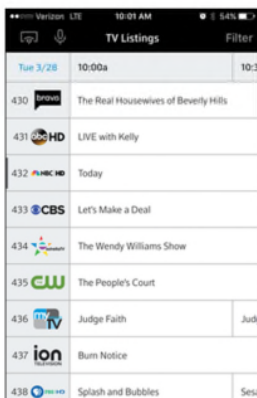

<https://www.xfinity.com/support/articles/setting-up-the-cable-tv-app>.

110. Defendant's infringement of the '669 Patent injured and is injuring NexStep in an amount to be proven at trial, but not less than a reasonable royalty.

111. Defendant has been long-aware of NexStep's patented technology, and continues its unauthorized infringing activity despite this knowledge. As discussed above, NexStep actively and diligently attempted to engage in good faith negotiations with Defendant. After being shown NexStep's patented technology in 2007, including the technology covered in the '669 Patent, on information and belief, Defendant copied this technology and made no effort to

avoid infringement when it later launched its Xfinity Internet, video (TV), and voice services on or about 2010. Instead, Defendant continued to incorporate NexStep's technology into additional products, such as those identified in this complaint, including remote control devices with voice activated controls. All of these actions demonstrate Defendant's willful, blatant and egregious disregard for NexStep's patent rights.

112. Despite its knowledge of NexStep's patented technology and its specific knowledge of its own infringement, Defendant continued to sell the Accused Products in complete and reckless disregard of NexStep's patent rights. As such, Defendant acted recklessly, willfully, wantonly, and deliberately engaged in acts of infringement of the '669 Patent, justifying an award to NexStep of increased damages under 35 U.S.C. § 284, and attorneys' fees and costs incurred under 35 U.S.C. § 285.

COUNT VI

(Indirect Infringement of the '669 Patent pursuant to 35 U.S.C. § 271(b))

113. NexStep repeats, realleges, and incorporates by reference, as if fully set forth herein, the allegations of the preceding paragraphs, as set forth above.

114. As discussed above, Defendant knew about NexStep's patented technology, including the '669 Patent, by at least 2007.

115. In addition to directly infringing the '669 Patent, Defendant knew or was willfully blind to the fact that it was inducing infringement of at least Claim 27 of the '669 Patent under 35 U.S.C. § 271(b) by instructing, directing and requiring its customers to perform the steps of the method claims of the '669 Patent, either literally or under the doctrine of equivalents.

116. Defendant knowingly and actively aided and abetted the direct infringement of the '669 Patent by instructing and encouraging its customers and developers to use the '669

Accused Products. Such instructions and encouragement included advising third parties to use the '669 Accused Products in an infringing manner, providing a mechanism through which third parties may infringe the '669 Patent, advertising and promoting the use of the '669 Accused Products in an infringing manner, and distributing guidelines and instructions to third parties on how to use the '669 Accused Products in an infringing manner.

COUNT VII

(Direct Infringement of the '710 Patent pursuant to 35 U.S.C. § 271(a))

117. NexStep repeats, realleges, and incorporates by reference, as if fully set forth herein, the allegations of the preceding paragraphs, as set forth above.

118. Defendant infringes at least Claim 7 of the '710 Patent in violation of 35 U.S.C. § 271(a).

119. Defendant's infringement is based upon literal infringement or, in the alternative, infringement under the doctrine of equivalents.

120. Defendant's acts of making, using, importing, selling, and offering for sale infringing products and services were without the permission, consent, authorization, or license of NexStep.

121. Defendant's infringement includes, the manufacture, use, sale, importation and offer for sale of Defendant's Xfinity Services, including equipment to make and use the Xfinity Services (collectively, the "'710 Accused Products").

122. The '710 Accused Products infringe the '710 Patent because Defendant makes, uses, and sells systems with remote control devices with audio reproduction, including audio inputs and outputs, a microphone, touch screen navigation controls and keyboards, audio processors, and Wi-Fi and Bluetooth communications, including a hardware stack running on

the hardware resources for exchanging and decoding packets with VoIP enabled set-top boxes and gateways.

123. To the extent the '710 Accused Products include hardware or software owned by third parties, the '710 Accused Products still infringe the '710 Patent because Defendant is vicariously liable for the manufacture and use of the patented system by controlling the entire system and deriving a benefit from the use of every element of the entire system. Similarly, to the extent Defendant's third parties (e.g., customers) form the '710 Accused Products or use their own equipment to form the '710 Accused Products, Defendant still infringes the '710 Patent because third parties' beneficial use of the '710 Accused Products is conditioned on combining the components in an infringing manner.

124. Defendant sells smartphones, software, and other equipment with instructions and users guides, to use its Xfinity Services, including Xfinity Apps.

<https://www.xfinity.com/mobile/shop?category=device>.

125. The '710 Accused Products, including Xfinity Apps such as TV Remote, Stream, Connect, xFi, and Home apps, infringe the '710 Patent because they provide systems and methods that allow customers to control set-top boxes, DVRs, VoD, and operate home security devices, among other features provided by Xfinity Apps described above.

126. The smartphones sold by Defendant running Xfinity Apps (e.g., iPhone XR) include a Wi-Fi and Bluetooth wireless link transceiver for sending and receiving data with gateways and set-top boxes working with Defendant's Cloud.

127. The smartphones sold by Defendant running Xfinity Apps include a slaved audio input such as a microphone built into the smartphone (functioning as a remote). The Xfinity Apps use the smartphone's microphone for audio input and voice assist.

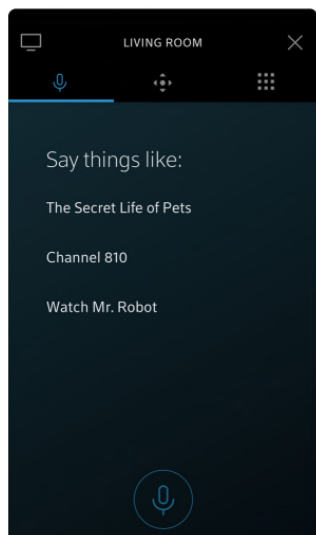

<https://itunes.apple.com/us/app/xfinity-tv-remote/id401629893?mt=8>.

128. Smartphones sold by Defendant running Xfinity Apps include navigation controls built into the App such as directional arrows and select/enter buttons (as shown below):

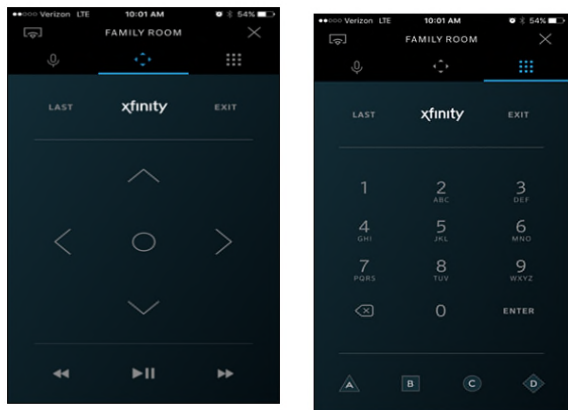

<https://www.xfinity.com/support/articles/setting-up-the-cable-tv-app>.

129. Smartphones, such as the iPhone XR, sold by Defendant running Xfinity Apps include hardware resources coupled between the wireless link transceiver, including a Bluetooth wireless transceiver for connecting wireless headphones, and the DRM port, slaved

audio input (streaming music/video and microphone), and navigation controls (e.g., touch screen processor). A smartphone has an audio codec, amplifier, and Bluetooth processor (which use digital rights management technology). The iPhone XR uses various audio codec (e.g. AAC codec) over Bluetooth and comply with Digital Rights Management (DRM) policies. Smartphones also include a touchscreen digitizer.

Bluetooth audio devices become more and more popular today – stereo headsets and headphones, wireless audio transmitters/receivers, cell phones and mp3 players with Bluetooth Advanced Audio Distribution Profile (A2DP). Headphones and headsets seems benefit the most from Bluetooth (BT) audio. To be honest first BT stereo headphones were of poor sound quality – dirty sound with annoying “hiss” on background. Definitely that was not because of BT technology limitations but mainly because of poor implementation of the latter and slipshod design of analog audio circuits. The situation changes slowly but steadily. For example modern BT stereo headphones DR-BT50 from Sony can successfully compete with ordinary wired ones already. Their sound quality will be sufficient for vast majority of portable player owners for sure. In no doubt if manufacturers decide they could produce perfectly sounding BT headphones for demanding listeners as well. In that case the way digital audio transmits over BT protocol is a bottleneck in the whole audio transmission chain.

As the data channel used by A2DP is only 721 kbps wide some data reduction scheme is required. While BT specifications allow using of different audio codecs (mp2, mp3, wma, aac and even atrac) the only mandatory codec for all BT audio devices is subband codec (SBC). In fact many BT headphones (including above mentioned DR-BT50) already support mp3 codec but in real life it remains unused. Obviously it was made for the sake of compatibility but the same time portable devices could benefit from direct streaming of mp3 files through BT interface saving both audio quality and battery life. However in today's practice all high quality audio still transfers over A2DP by means of SBC codec.

SBC codec appeared in SoundExpert ratings more than two years ago (see [320+ kbit/s section](#)). The bitrate used for testing (372 kbps) showed good potential of this compression scheme but it's clear now that above setting doesn't reflect real-life scenario of the codec use. Let's look for example at these two major BT applications:

Toshiba Bluetooth stack for Windows (6.10) has three quality modes for SBC codec

- High Quality – 328 kbps
- Middle Quality – 229kbps
- Low Quality – 201 kbps

IVT Corp. Bluesoleil (5.0.5) has two quality modes: High and Middle. It's not mentioned what bitrates are used but the application has special “Status Window” available for any BT connection. Among other information it shows amount of bytes sent to and received from connected device. Simple calculations reveal the same bit rates for High and Middle quality modes – 328 kbps and 229 kbps. As Bluesoleil is capable of both sending and receiving A2DP audio data its status window helps to discover actual bitrates used by any connected BT device. For example cell phone Nokia 6500 classic also sends music to BT interface at 229 kbps and the bitrate can't be altered in phone's settings (may be some advanced music phones and players have such possibility, though).

Such unanimity in choosing SBC codec settings is not surprising. Bluetooth Special Interest Group (SIG) recommends using of those settings in A2DP specifications (A2DP_SPEC, Revision V12):

Ex. 15.

130. Smartphones, such as the iPhone XR, sold by Defendant running Xfinity Apps include a stack running on the hardware resources to exchange packets between audio processors and main processors and set top boxes/DVRs (e.g., where the main processor or set-top boxes/gateways can perform functions of a master device) via a stack (e.g., Wi-Fi and Bluetooth protocol stack or network stack for implementing communication protocols between the set-top boxes working with Defendant's media servers and remote controls) running on the hardware resources. A smartphone using the Xfinity Apps can stream a customer's DVR

recordings to his/her smartphone. A stack running on the smartphone (described above) exchanges packets with a gateway and set-top boxes working with Defendant's Cloud.

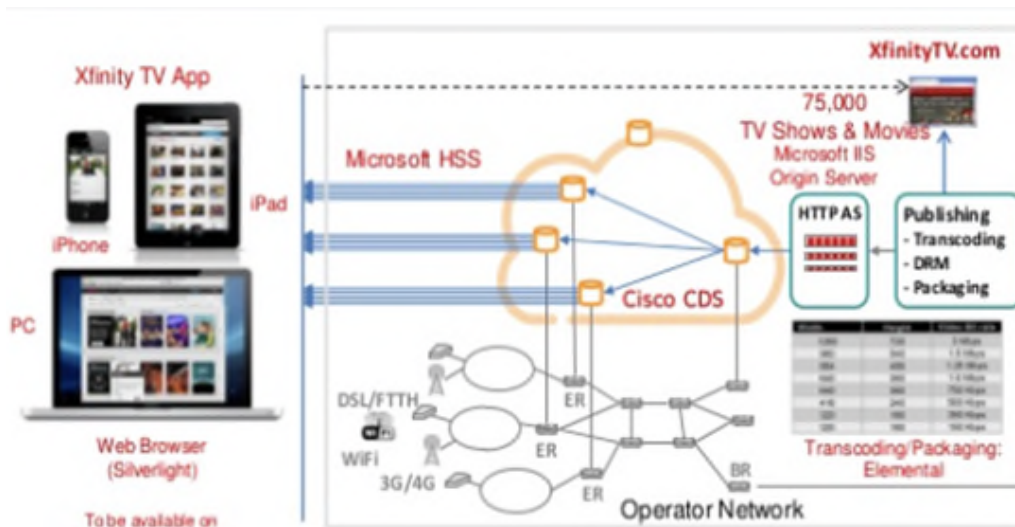

Ex. 16.

131. Smartphones sold by Defendant running Xfinity Apps include encoder logic coupled to the stack for encoding/processing audio, such as voice input from a microphone. The Xfinity App converts the audio input into a remote-control audio format that can be processed by the Xfinity set-top boxes/gateways and Defendant's Cloud.

<https://itunes.apple.com/us/app/xfinity-tv-remote/id401629893?mt=8>.

132. Smartphones sold by Defendant running Xfinity Apps use the set-top boxes working with Comcast media servers to transcode input from the smartphone's slaved audio input to VoIP from the remote control device format. The Xfinity Remote and Stream Apps format the audio input from the slaved microphone into a remote control device format sent by Wi-Fi to the set-top boxes/gateways. The set-top boxes/gateways transcode this input to VoIP.

<https://www.xfinity.com/support/articles/setting-up-the-cable-tv-app>; *see also*,

<https://www.xfinity.com/support/articles/eligible-cable-boxes-cable-tv-app>.

133. Defendant's infringement of the '710 Patent injured and is injuring NexStep in an amount to be proven at trial, but not less than a reasonable royalty.

134. Defendant has been long-aware of NexStep's patented technology, and continues its unauthorized infringing activity despite this knowledge. As discussed above, NexStep actively and diligently attempted to engage in good faith negotiations with Defendant. After being shown NexStep's patented technology in 2007, including the technology covered in the '710 Patent, on information and belief, Defendant copied this technology and made no effort to avoid infringement when it later launched its initial Xfinity Internet, video (TV), and voice services on or about 2010. Instead, Defendant continued to incorporate NexStep's technology into additional products, such as those identified in this complaint, including remote control devices with voice activated controls. All of these actions demonstrate Defendant's willful, blatant and egregious disregard for NexStep's patent rights.

135. Despite its knowledge of NexStep's patented technology and its specific knowledge of its own infringement, Defendant continued to sell the Accused Products in complete and reckless disregard of NexStep's patent rights. As such, Defendant acted recklessly, willfully, wantonly, and deliberately engaged in acts of infringement of the '710 Patent, justifying an award to NexStep of increased damages under 35 U.S.C. § 284, and attorneys' fees and costs incurred under 35 U.S.C. § 285.

COUNT VIII

(Indirect Infringement of the '710 Patent pursuant to 35 U.S.C. § 271(b))

136. NexStep repeats, realleges, and incorporates by reference, as if fully set forth herein, the allegations of the preceding paragraphs, as set forth above.

137. As discussed above, Defendant knew about NexStep's patented technology, including the '710 Patent, by at least 2007.

138. In addition to directly infringing the '710 Patent, Defendant knew or was willfully blind to the fact that it was inducing infringement of at least Claim 7 the '710 Patent under 35 U.S.C. § 271(b) by instructing, directing and requiring third parties (e.g., customers) to use and combine the components of the system claims of the '710 Patent, either literally or under the doctrine of equivalents.

139. Defendant knowingly and actively aided and abetted the direct infringement of the '710 Patent by instructing and encouraging its customers and developers to use the '710 Accused Products. Such instructions and encouragement included advising third parties to use the '710 Accused Products in an infringing manner, providing a mechanism through which third parties may infringe the '710 Patent, advertising and promoting the use of the '710 Accused Products in an infringing manner, and distributing guidelines and instructions to third parties on how to use the '710 Accused Products in an infringing manner.

COUNT IX

(Direct Infringement of the '009 Patent pursuant to 35 U.S.C. § 271(a))

140. NexStep repeats, realleges, and incorporates by reference, as if fully set forth herein, the allegations of the preceding paragraphs, as set forth above.

141. Defendant infringes at least Claim 1 of the '009 Patent in violation of 35 U.S.C. § 271(a).

142. Defendant's infringement is based upon literal infringement or, in the alternative, infringement under the doctrine of equivalents.

143. Defendant's acts of making, using, importing, selling, and offering for sale infringing products and services were without the permission, consent, authorization, or license of NexStep.

144. Defendant's infringement includes, the manufacture, use, sale, importation and offer for sale of Defendant's Xfinity Services, including equipment to make and use the Xfinity Services (collectively, the "'009 Accused Products").

145. The '009 Accused Products infringe the '009 Patent because Defendant performs and makes, uses, and sells systems for customers to perform the patented method of using a remote control device to initiate a support session for a consumer concierge device via a single action.

146. To the extent the '009 Accused Products include hardware or software owned by third parties, the '009 Accused Products still infringe the '009 Patent because Defendant is vicariously liable for the manufacture and use of the patented system by controlling the entire system and deriving a benefit from the use of every element of the entire system. Similarly, to the extent Defendant's third parties (e.g., customers) form the '009 Accused Products or use their own equipment to form the '009 Accused Products, including performance of one or more patented steps, Defendant still infringes the '009 Patent because third parties' beneficial use of the '009 Accused Products is conditioned on combining the components and performing one or more steps of the methods in an infringing manner as established by Defendant.

147. The '009 Accused Products, including Xfinity Apps such as My Account, Connect, xFi, and Authenticator among other features found in Xfinity Apps described above infringe the '009 Patent.

148. Defendant sells smartphones, software, and other equipment with instructions and users guides, to use its Xfinity Services, including Xfinity Apps.

<https://www.xfinity.com/mobile/shop?category=device>.

149. The '009 Accused Products, including Xfinity Apps such as My Account, Connect, xFi, and Authenticator, and Home apps, infringe the '009 Patent because they provide systems and methods that allow customers to control set-top boxes, DVRs, VoD, and operate home security devices, among other features provided by Xfinity Apps described above.

150. Smartphones sold by Defendant running the Xfinity Apps such as My Account App provides Defendant's customers a method to access their accounts, pay their bills, troubleshoot hardware and software issues, contact Comcast, schedule service visits or customer support calls.

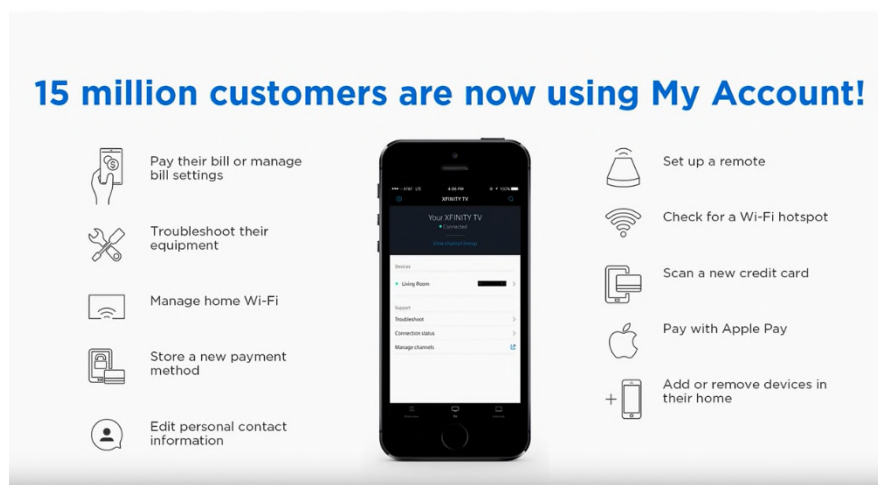

<https://www.youtube.com/watch?v=WdaMJy1nSQw>.

151. The Xfinity My Account App can be accessed through mobile phones (e.g., using cellular and Wi-Fi transmission), on the Internet or through the Xfinity X1 set top boxes. It can be downloaded from the Apple or iTunes app stores.

Access from Settings

Press **MENU** on your remote, and select the **Settings** icon.

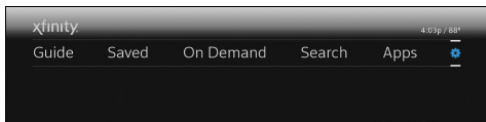

My Account will be the first option listed. Press the **OK** button.

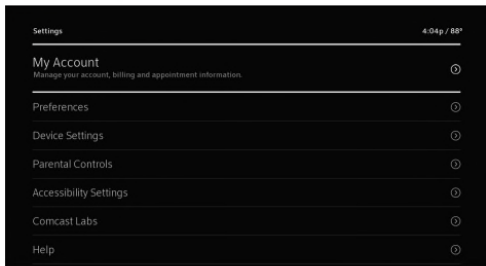

Access from Apps Menu

The icon for the Xfinity My Account app appears in the **XFINITY** section of the **Apps** menu. Highlight the app tile and press **OK** on your remote control.

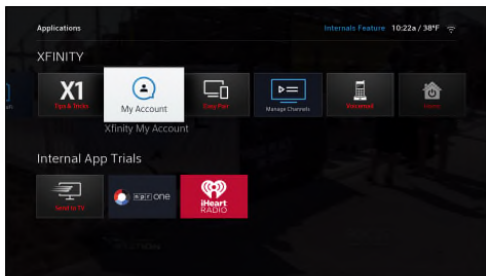

<https://www.xfinity.com/support/articles/using-the-my-account-app>.

152. A smartphone device sold by Defendant running the Xfinity Apps acts as a concierge device because it allows users to access options and information relating to their account, TV, Internet or voice services. Users can tell the app which services or devices are having problems. Once a device is selected, the app will allow the user to access troubleshooting guides as well as “Common Problems & Solutions” which are customized to the consumers’ devices:

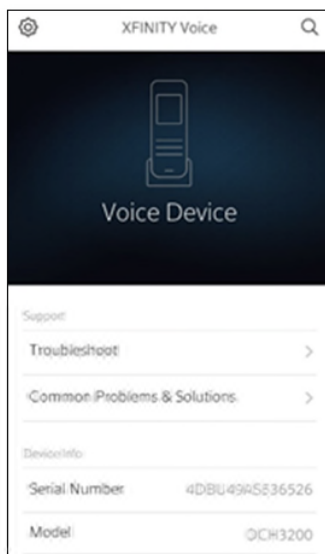
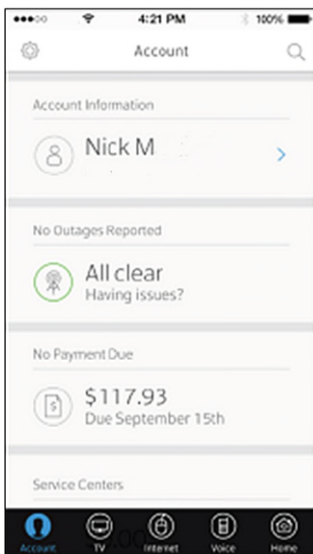

[https://www.xfinity.com/support/articles/my-account-app-mobile-sign-in;](https://www.xfinity.com/support/articles/my-account-app-mobile-sign-in)
[https://www.xfinity.com/support/articles/my-account-app-voice-mobile-troubleshooting.](https://www.xfinity.com/support/articles/my-account-app-voice-mobile-troubleshooting)

153. A smartphone device sold by Defendant running the Xfinity Apps can, with a single click on the smartphone, communicate with the Xfinity X1 set top boxes working with Defendant’s Cloud, and provide the user with support relating to their individual products and services.

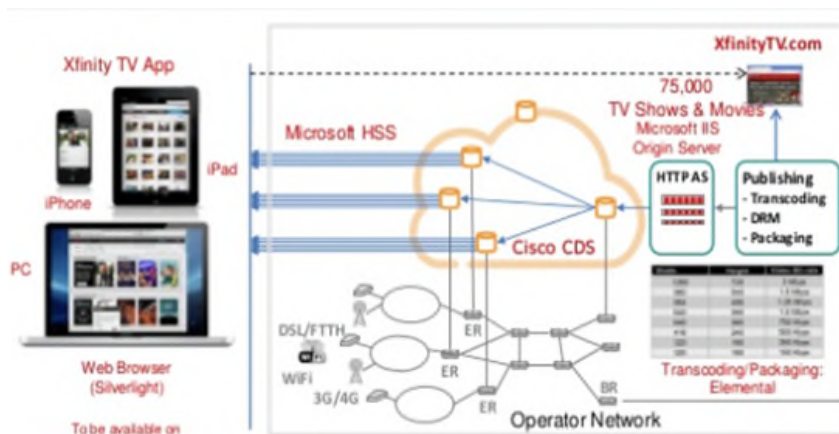

Ex. 16.

154. A smartphone device sold by Defendant running the Xfinity Apps can be used to choose which device is in need of service or repair and can communicate with the home gateways (e.g., xFi Wireless Gateway and Defendant's Cloud) via the My Account App.

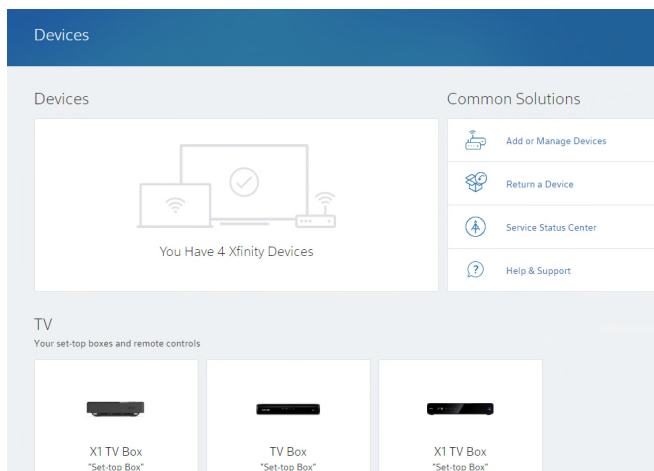

<https://customer.xfinity.com/#/devices>.

155. A smartphone device sold by Defendant running the Xfinity Apps can, based on the device selected by the user and the buffered data collected from same, use the My Account App with one click to have the app pull information, guides, and automated troubleshooting steps relating to that device with one click.

156. A smartphone device sold by Defendant running the Xfinity Apps can select a device and cause the home gateways (e.g., xFi Wireless Gateway and Defendant's Cloud) to initiate a support session which can take the form of step-by-step tutorials, diagnostics or scheduling of a call with a live service representative. The app launches an automated protocol regarding how to fix certain issues with that specific product or services.

157. If the automated support protocol does not resolve the user's issues, he or she may schedule a call with a customer support representative at a time of the user's choosing, allowing the user to avoid automated attendants or interactive voice recognition systems:

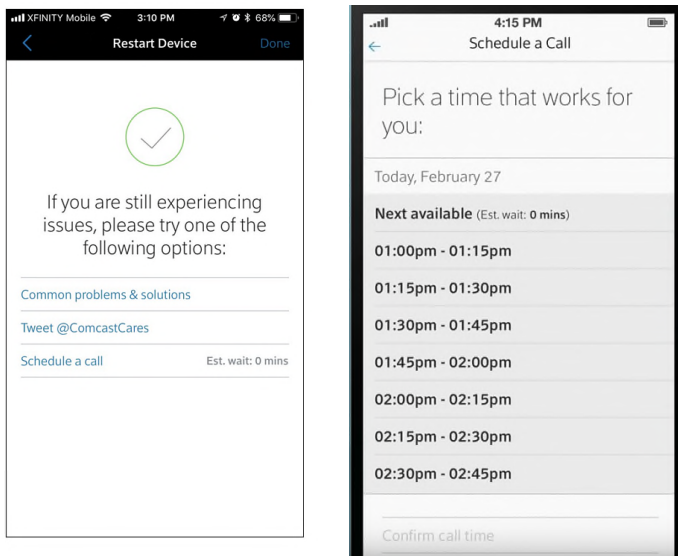

[https://www.xfinity.com/support/articles/my-account-app-internet-mobile-troubleshooting;](https://www.xfinity.com/support/articles/my-account-app-internet-mobile-troubleshooting)
[https://www.youtube.com/watch?v=WdaMJy1nSQw.](https://www.youtube.com/watch?v=WdaMJy1nSQw)

158. Defendant's infringement of the '009 Patent injured and is injuring NexStep in an amount to be proven at trial, but not less than a reasonable royalty.

159. Defendant has been long-aware of NexStep's patented technology, and continues its unauthorized infringing activity despite this knowledge. As discussed above, NexStep actively and diligently attempted to engage in good faith negotiations with Defendant. After being shown NexStep's patented technology in 2007, including the technology covered in the '009 Patent, on information and belief, Defendant copied this technology and made no effort to avoid infringement when they later launched its initial Xfinity Internet, video (TV), and voice services on or about 2010. Instead, Defendant continued to incorporate NexStep's technology into additional products, such as those identified in this complaint, including remote control devices with voice activated controls. All of these actions demonstrate Defendant's willful, blatant and egregious disregard for NexStep's patent rights.

160. Despite its knowledge of NexStep's patented technology and its specific knowledge of its own infringement, Defendant continued to sell the Accused Products in

complete and reckless disregard of NexStep's patent rights. As such, Defendant acted recklessly, willfully, wantonly, and deliberately engaged in acts of infringement of the '009 Patent, justifying an award to NexStep of increased damages under 35 U.S.C. § 284, and attorneys' fees and costs incurred under 35 U.S.C. § 285.

COUNT X

(Indirect Infringement of the '009 Patent pursuant to 35 U.S.C. § 271(b))

161. NexStep repeats, realleges, and incorporates by reference, as if fully set forth herein, the allegations of the preceding paragraphs, as set forth above.

162. As discussed above, Defendant knew about NexStep's patented technology, including the '009 Patent, by at least 2007.

163. In addition to directly infringing the '009 Patent, Defendant knew or was willfully blind to the fact that it was inducing infringement of at least Claim 1 the '009 Patent under 35 U.S.C. § 271(b) by instructing, directing and requiring third parties (e.g., customers) to use, combine the components of the system claims and perform the steps of the method claims of the '009 Patent, either literally or under the doctrine of equivalents.

164. Defendant knowingly and actively aided and abetted the direct infringement of the '009 Patent by instructing and encouraging its customers and developers to use the '009 Accused Products. Such instructions and encouragement included advising third parties to use the '009 Accused Products in an infringing manner, providing a mechanism through which third parties may infringe the '009 Patent, advertising and promoting the use of the '009 Accused Products in an infringing manner, and distributing guidelines and instructions to third parties on how to use the '009 Accused Products in an infringing manner.

COUNT XI

(Direct Infringement of the ‘132 Patent pursuant to 35 U.S.C. § 271(a))

165. NexStep repeats, realleges, and incorporates by reference, as if fully set forth herein, the allegations of the preceding paragraphs, as set forth above.

166. Defendant infringes at least Claim 7 of the ‘132 Patent in violation of 35 U.S.C. § 271(a).

167. Defendant’s infringement is based upon literal infringement or, in the alternative, infringement under the doctrine of equivalents.

168. Defendant’s acts of making, using, importing, selling, and offering for sale infringing products and services were without the permission, consent, authorization, or license of NexStep.

169. Defendant’s infringement includes, the manufacture, use, sale, importation and offer for sale of Defendant’s Xfinity Services, including equipment to make and use the Xfinity Services (collectively, the “132 Accused Products”).

170. The ‘132 Accused Products infringe the ‘132 Patent because Defendant makes, uses and sells systems with a remote control device with audio reproduction, including audio inputs and outputs, a microphone, touch screen navigation controls and keyboards, audio processors, and Wi-Fi and Bluetooth communications, including a hardware stack running on the hardware resources for exchanging and decoding packets with VoIP enabled set-top boxes and gateways.

171. To the extent the ‘132 Accused Products include hardware or software owned by third parties, the ‘132 Accused Products still infringe the ‘132 Patent because Defendant is vicariously liable for the manufacture and use of the patented system by controlling the entire system and deriving a benefit from the use of every element of the entire system. Similarly, to

the extent Defendant's third parties (e.g., customers) form the '132 Accused Products or use their own equipment to form the '132 Accused Products, Defendant still infringes the '132 Patent because third parties' beneficial use of the '132 Accused Products is conditioned on combining the components in an infringing manner.

172. Defendant sells smartphones, software, and other equipment with instructions and users guides, to use its Xfinity Services, including Xfinity Apps.

<https://www.xfinity.com/mobile/shop?category=device>.

173. The '132 Accused Products, including Xfinity Apps such as TV Remote, Stream, Connect, xFi, and Home apps, infringe the '132 Patent because they provide systems and methods that allow customers to control set-top boxes, DVRs, VoD, and operate home security devices, among other features provided by Xfinity Apps described above.

174. The smartphones sold by Defendant and running Xfinity Apps (e.g., Galaxy S9) operate as remote controls and can, for example, change channels, browse Xfinity's VoD and TV listings, DVR recordings, operate voice activated searches, and operate home security devices.

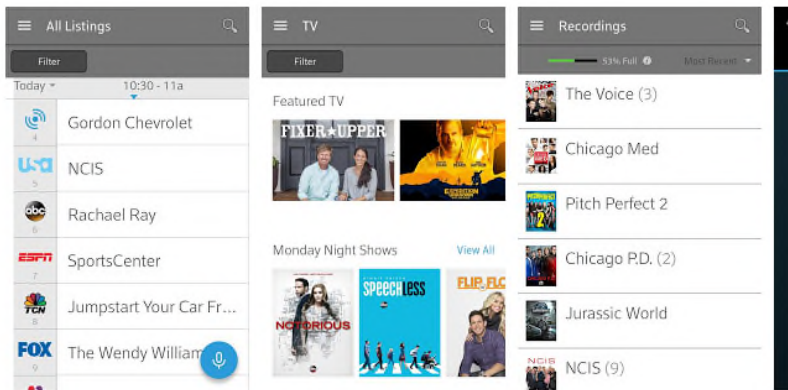
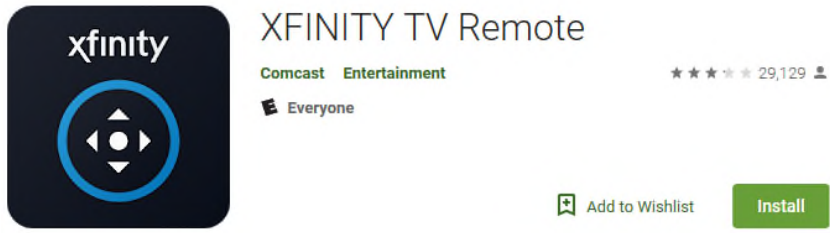

Use your smartphone or tablet as a remote control. Change channels, browse XFINITY On Demand and TV listings. If you're an X1 customer, you can now bring the power of X1 voice remote to your mobile device.

<https://play.google.com/store/apps/details?id=com.xfinity.tv&hl=en>.

175. The Galaxy S9 sold by Defendant running Xfinity Apps includes Wi-Fi and Bluetooth wireless link RF transceivers. They are used to exchange packets with the Bluetooth chipset present in the main set-top boxes working with the gateways

- Murata KM7N07016 Wi-Fi/Bluetooth module
- NXP PN80T NFC controller
- Qualcomm PM845 (likely PMIC)
- Qualcomm SDR845 RF transceiver
- Hard to make out, but we think this is likely the same Skyworks SKY78160-11 front-end module we found in the S9+
- Qualcomm PM8005 PMIC

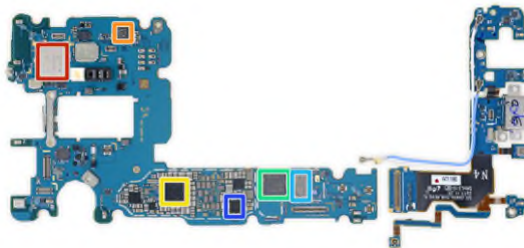

Ex. 10.

176. The Galaxy S9 sold by Defendant running Xfinity Apps includes a slaved audio input, i.e., a microphone and transceiver for outputting audio data. The controls on the

touchscreen display are used to trigger various events and functions such navigation/directional buttons, play/pause, rewind, menu and select buttons.

177. The Galaxy S9 sold by Defendant running the Xfinity Apps includes a coprocessor, which converts/encodes the audio and is capable of utilizing assisted A2DP. **Ex. 13.** The Galaxy S9 sold by Defendant running the Xfinity Apps processes the audio into a remote control audio format so it can be processed by the gateways and the set-top boxes working with Defendant’s Cloud:

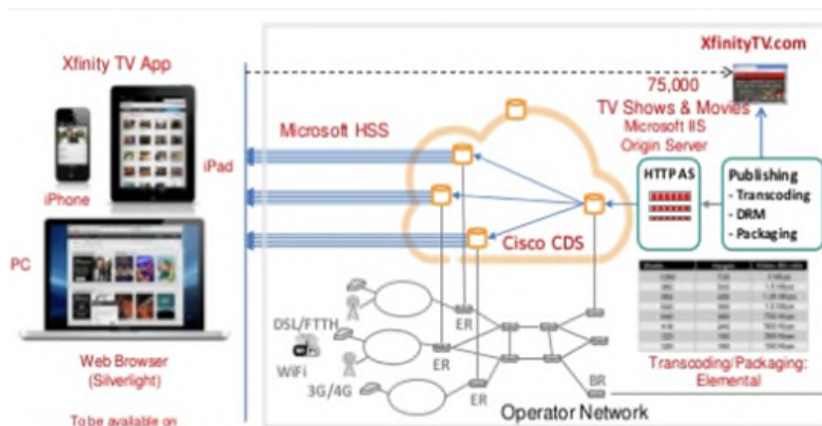

Ex. 16.

178. Defendant’s infringement of the ‘132 Patent injured and is injuring NexStep in an amount to be proven at trial, but not less than a reasonable royalty.

179. Defendant has been long-aware of NexStep’s patented technology, and continues its unauthorized infringing activity despite this knowledge. As discussed above, NexStep actively and diligently attempted to engage in good faith negotiations with Defendant. After being shown NexStep’s patented technology in 2007, including the technology covered in the ‘132 Patent, on information and belief, Defendant copied this technology and made no effort to avoid infringement when it later launched its initial Xfinity Internet, video (TV), and voice services on or about 2010. Instead, Defendant continued to incorporate NexStep’s technology into additional products, such as those identified in this complaint, including remote control

devices with voice activated controls. All of these actions demonstrate Defendant's willful, blatant and egregious disregard for NexStep's patent rights.

180. Despite its knowledge of NexStep's patented technology and its specific knowledge of its own infringement, Defendant continued to sell the Accused Products in complete and reckless disregard of NexStep's patent rights. As such, Defendant acted recklessly, willfully, wantonly, and deliberately engaged in acts of infringement of the '132 Patent, justifying an award to NexStep of increased damages under 35 U.S.C. § 284, and attorneys' fees and costs incurred under 35 U.S.C. § 285.

COUNT XII

(Indirect Infringement of the '132 Patent pursuant to 35 U.S.C. § 271(b))

181. NexStep repeats, realleges, and incorporates by reference, as if fully set forth herein, the allegations of the preceding paragraphs, as set forth above.

182. As discussed above, Defendant knew about NexStep's patented technology, including the '132 Patent, by at least 2007.

183. In addition to directly infringing the '132 Patent, Defendant knew or was willfully blind to the fact that it was inducing infringement of at least Claim 1 the '132 Patent under 35 U.S.C. § 271(b) by instructing, directing and requiring third parties (e.g., customers) to use and combine the components of the system claims of the '132 Patent, either literally or under the doctrine of equivalents.

184. Defendant knowingly and actively aided and abetted the direct infringement of the '132 Patent by instructing and encouraging its customers and developers to use the '132 Accused Products. Such instructions and encouragement included advising third parties to use the '132 Accused Products in an infringing manner, providing a mechanism through which third parties may infringe the '132 Patent, advertising and promoting the use of the

‘132 Accused Products in an infringing manner, and distributing guidelines and instructions to third parties on how to use the ‘132 Accused Products in an infringing manner.

COUNT XIII

(Direct Infringement of the ‘130 Patent pursuant to 35 U.S.C. § 271(a))

185. NexStep repeats, realleges, and incorporates by reference, as if fully set forth herein, the allegations of the preceding paragraphs, as set forth above.

186. Defendant infringes at least Claim 10 of the ‘130 Patent in violation of 35 U.S.C. § 271(a).

187. Defendant’s infringement is based upon literal infringement or, in the alternative, infringement under the doctrine of equivalents.

188. Defendant’s acts of making, using, importing, selling, and offering for sale infringing products and services were without the permission, consent, authorization, or license of NexStep.

189. Defendant’s infringement includes, the manufacture, use, sale, importation and offer for sale of Defendant’s Xfinity Services, including equipment to make and use the Xfinity Services (collectively, the “130 Accused Products”).

190. The ‘130 Accused Products infringe the ‘130 Patent because Defendant makes, uses, and sells systems with a remote control device with audio and video reproduction, including inputs and outputs, a microphone, touch screen displays with navigation controls, keyboards and trigger controls, audio processors, and Wi-Fi and/or Bluetooth communications, including a stack running on the hardware resources for exchanging packets with set-top boxes with media cards (e.g., instant replay SD card) and VoIP enabled gateways.

191. To the extent the ‘130 Accused Products include hardware or software owned by third parties, the ‘130 Accused Products still infringe the ‘130 Patent because Defendant is

vicariously liable for the manufacture and use of the patented system by controlling the entire system and deriving a benefit from the use of every element of the entire system. Similarly, to the extent Defendant's third parties (e.g., customers) form the '130 Accused Products or use their own equipment to form the '130 Accused Products, Defendant still infringes the '130 Patent because Defendant conditions the beneficial use of the '130 Accused Products on combining the components in an infringing manner and Defendant directs and controls their use of the '130 Accused Products.

192. Defendant sells smartphones, software, and other equipment with instructions and users guides, to use its Xfinity Services, including Xfinity Apps.

<https://www.xfinity.com/mobile/shop?category=device>.

193. The '130 Accused Products, including Xfinity Apps such as TV Remote, Stream, Connect, xFi, and Home apps, infringe the '130 Patent because they provide systems and methods that allow customers to control set-top boxes, DVRs, VoD, and operate home security devices, among other features provided by Xfinity Apps described above.

194. The smartphone (e.g., Galaxy S9) sold by Defendant comprises a limited range radio, which is a Qualcomm SDR 845 RF Transceiver and Murata Wi-Fi/Bluetooth module shown below in the green and red box respectively:

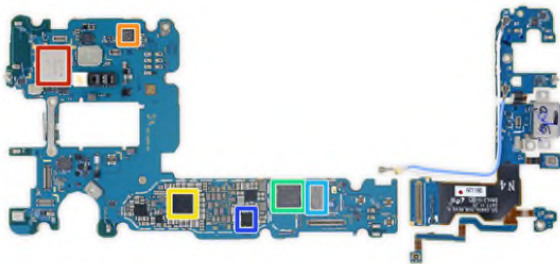

- Murata KM7N07016 Wi-Fi/Bluetooth module
- NXP PN80T NFC controller
- Qualcomm PM845 (likely PMIC)
- Qualcomm SDR845 RF transceiver
- Hard to make out, but we think this is likely the same Skyworks SKY78160-11 front-end module we found in the S9+
- Qualcomm PM8005 PMIC

Ex. 10.

195. The Galaxy S9 sold by Defendant includes a plurality of slaved inputs and outputs, e.g., a microphone, a transceiver for translating audio data, speakers, touchscreen keyboard and navigation controls, and plurality of antennas as shown below:

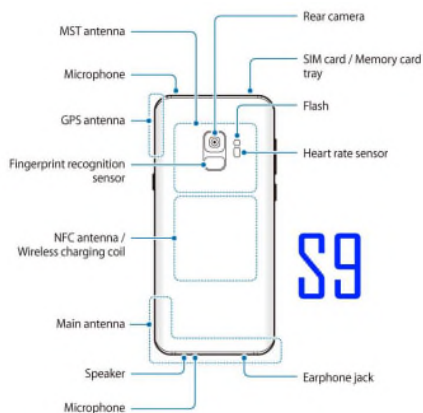

Ex. 11.

196. The Galaxy S9 sold by Defendant running the Xfinity Apps use the directional (up, down, left, right) pad on the app for on-screen navigation:

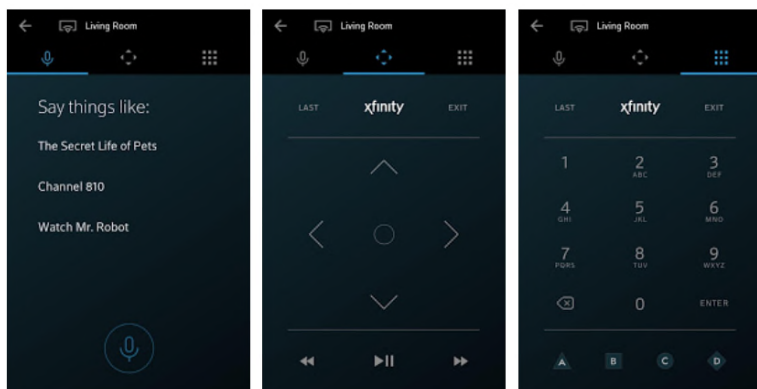

https://play.google.com/store/apps/details?id=com.xfinity.tv&hl=en_US

197. The Galaxy S9 sold by Defendant running the Xfinity Apps couples the hardware resources with the wireless link transceiver, the slaved audio input and the navigation control to function with VoIP enabled gateways and set-top boxes working with Defendant's Cloud. The Galaxy S9 sold by Defendant running the Xfinity Apps uses Qualcomm SDR 845 RF Transceiver and the Murata Bluetooth chipset along with Qualcomm microcontroller chipset, both present on Galaxy S9, exchange packets with the Bluetooth chipset present in the set-top boxes and Wi-Fi receivers in the VoIP gateways. **Ex. 12.**

198. The Galaxy S9 sold by Defendant running the Xfinity Apps coprocessor, which converts/encodes the audio and is capable of utilizing assisted A2DP, to process the audio into a remote control audio format. Assisted A2DP enables wireless transmission of audio between two devices (as shown below).

6.4.4.2 Assisted A2DP

The advanced audio distribution profile (A2DP) enables wireless transmission of high-quality mono or stereo audio between two devices. A2DP defines two roles:

- A2DP source is the transmitter of the audio stream.
- A2DP sink is the receiver of the audio stream.

Ex, 13.

199. The set-top boxes include media card readers and network connections to allow the Galaxy S9 running Xfinity Apps to play and retrieve digital content available from the set-top boxes working with Defendant's Cloud, including access to VoIP service and video (TV) services.

200. Defendant's infringement of the '130 Patent injured and is injuring NexStep in an amount to be proven at trial, but not less than a reasonable royalty.

201. Defendant has been long-aware of NexStep's patented technology, and continues its unauthorized infringing activity despite this knowledge. As discussed above, NexStep actively and diligently attempted to engage in good faith negotiations with Defendant. After being shown NexStep's patented technology in 2007, including the technology covered in the '130 Patent, on information and belief, Defendant copied this technology and made no effort to avoid infringement when it later launched its initial Xfinity Internet, video (TV), and voice services on or about 2010. Instead, Defendant continued to incorporate NexStep's technology into additional products, such as those identified in this complaint, including remote control devices with voice activated controls. All of these actions demonstrate Defendant's willful, blatant and egregious disregard for NexStep's patent rights.

202. Despite its knowledge of NexStep's patented technology and its specific knowledge of its own infringement, Defendant continued to sell the Accused Products in complete and reckless disregard of NexStep's patent rights. As such, Defendant acted recklessly, willfully, wantonly, and deliberately engaged in acts of infringement of the '130 Patent, justifying an award to NexStep of increased damages under 35 U.S.C. § 284, and attorneys' fees and costs incurred under 35 U.S.C. § 285.

COUNT XIV

(Indirect Infringement of the '130 Patent pursuant to 35 U.S.C. § 271(b))

203. NexStep repeats, realleges, and incorporates by reference, as if fully set forth herein, the allegations of the preceding paragraphs, as set forth above.

204. As discussed above, Defendant knew about NexStep's patented technology, including the '130 Patent, by at least 2007.

205. In addition to directly infringing the '130 Patent, Defendant knew or was willfully blind to the fact that it was inducing infringement of at least Claim 10 of the '130 Patent under 35 U.S.C. § 271(b) by instructing, directing and requiring third parties (e.g., customers) to use and combine the components of the system claims of the '130 Patent, either literally or under the doctrine of equivalents.

206. Defendant knowingly and actively aided and abetted the direct infringement of the '130 Patent by instructing and encouraging its customers and developers to use the '130 Accused Products. Such instructions and encouragement included advising third parties to use the '130 Accused Products in an infringing manner, providing a mechanism through which third parties may infringe the '130 Patent, advertising and promoting the use of the '130 Accused Products in an infringing manner, and distributing guidelines and instructions to third parties on how to use the '130 Accused Products in an infringing manner.

COUNT XV

(Direct Infringement of the '964 Patent pursuant to 35 U.S.C. § 271(a))

207. NexStep repeats, realleges, and incorporates by reference, as if fully set forth herein, the allegations of the preceding paragraphs, as set forth above.

208. Defendant infringes at least Claim 11 of the '964 Patent in violation of 35 U.S.C. § 271(a).

209. Defendant's infringement is based upon literal infringement or, in the alternative, infringement under the doctrine of equivalents.

210. Defendant's acts of making, using, importing, selling, and offering for sale infringing products and services were without the permission, consent, authorization, or license of NexStep.

211. Defendant's infringement includes, the manufacture, use, sale, importation and offer for sale of Defendant's Xfinity Services, including equipment to make and use the Xfinity Services (collectively, the "964 Accused Products").

212. Defendant sells and provides set-top boxes with XR11 or XR15 remote controls. Defendant also sells smartphones, software, and other equipment with instructions and users guides, to use its Xfinity Services, including Xfinity Apps.

<https://www.xfinity.com/mobile/shop?category=device>.

213. The '964 Accused Products infringe the '964 Patent because Defendant installs Xfinity Apps in non-transitory computer readable medium with instructions to be executed on smartphone for onboarding a control device (e.g., remote) and controlled device (e.g., set-top boxes, home security devices, etc.), and induce customers to do the same.

214. To the extent the '964 Accused Products include hardware or software owned by third parties, the '964 Accused Products still infringe the '964 Patent because Defendant is vicariously liable for the manufacture and use of the patented system by controlling the entire system and deriving a benefit from the use of every element of the entire system. Similarly, to the extent Defendant's third parties (e.g., customers) form the '964 Accused Products or use their own equipment to form the '964 Accused Products, including performance of one or more patented steps, Defendant still infringes the '964 Patent because third parties' beneficial use of

the '964 Accused Products is conditioned on combining the components and performing one or more steps of the methods in an infringing manner as established by Defendant.

215. When computer instructions are executed on one or more processors of a handheld concierge device (e.g., smartphone) and a control gateway (e.g., xFi Wireless Gateway and Defendant's Cloud), they cause the device to perform the method of on boarding both a control device (e.g., TV Remote or smartphone) and a controlled device (e.g., set-top boxes working with Comcast media servers, cameras, lights, outlets, and thermostat).

216. Defendant provides instructions and directs customers on how to setup, activate and use the X1 services and Xfinity Apps, including set-top boxes, wireless gateways, and home device (e.g., alarms, cameras, lights, locks, and thermostats).



<https://www.youtube.com/watch?v=r2rbXaFX1XM&feature=youtu.be>.

Setup Videos

Click on the link below to open each Self-Install video:

- [Self-Install X1](#)
- [Self-Install Xfinity TV](#)
- [Self-Install a TV Adapter](#)
- [Self-Install Xfinity Internet](#)
- [Self-Install Xfinity Internet and Xfinity Voice](#)

<https://www.xfinity.com/support/articles/how-to-install-your-self-install-kit-devices>.



<https://www.xfinity.com/support/articles/connecting-works-with-xfinity-home-device>.

217. Xfinity provides instructions for installing and customizing connections to Home Devices, including alarm systems.

A screenshot of a webpage for Xfinity Home security. The main heading is 'FEATURES' followed by 'Customize your system to fit your needs'. Below this, it lists features like smoke monitoring, remote thermostat control, and live video monitoring. A sub-section titled 'Included equipment' shows a hand holding a remote control and a smartphone displaying the Xfinity Home app. The text next to the app says 'Get started with some key pieces of security equipment included with your service.' There is also a link 'Learn About Xfinity Home' and a disclaimer '*Taxes and fees extra. Pricing subject to change.'.

<https://www.xfinity.com/learn/home-security>.

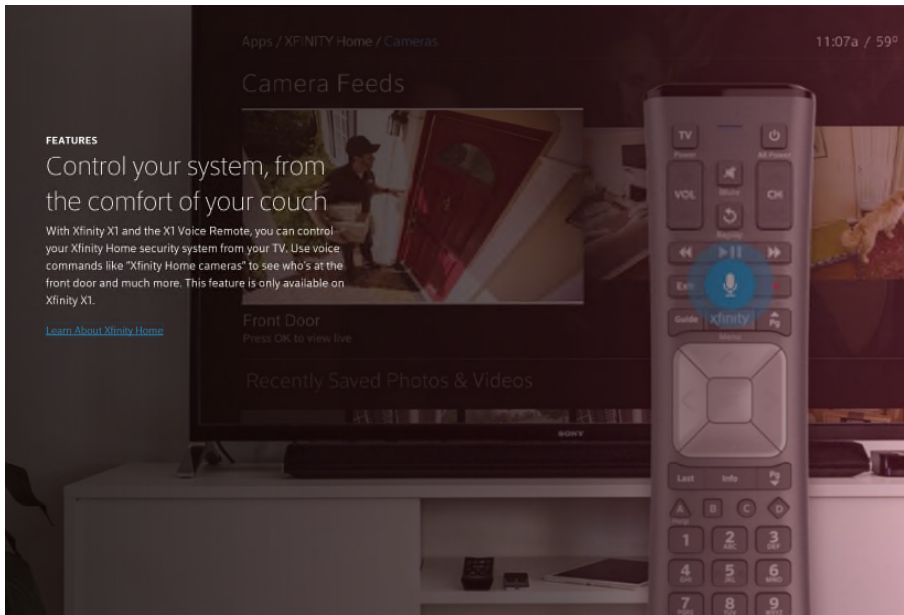

<https://www.xfinity.com/learn/home-security>.

218. Xfinity home devices can be controlled via Wi-Fi and Bluetooth communications from a customer’s TV (using the Xfinity TV Remote) or by using the Xfinity App on a smartphone.



THE XFINITY INTEGRATION

Access Xfinity Home from your TV

Don't get up! With Xfinity X1 and the X1 Voice Remote, use voice commands like "Xfinity Home cameras" to view live video monitoring, and more – all from the comfort of your couch and only with Xfinity Home.

[Learn About X1 And Voice](#)

<https://www.xfinity.com/learn/home-security/features>.

SMART HOME CONTROL

Stay connected to your home from anywhere

In addition to remotely arming and disarming your system with the Xfinity Home app, you can also look after and control your home from anywhere. With additional equipment, get live video monitoring so you can see that your kids got home safely, control your thermostat and turn on lights so you never come home to a dark house again, and much more.

[Explore Remote Access](#)

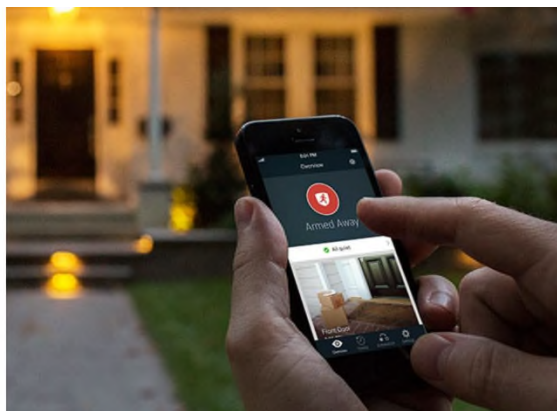

<https://www.xfinity.com>.

219. In one example, Xfinity set-top boxes connected to Xfinity networked media servers are a controllable device. The Xfinity XR11/XR15 remote is the control device. The set-top boxes connected to Xfinity networked media servers and the Xfinity XR11/XR15 remote are paired to each other. As part of the pairing process, the set-top boxes are paired/associated with customers' accounts using their IDs (e.g., Host ID, Data, and Unit Address) and connected to Xfinity media servers. The set-top boxes also send signals with their IDs to the TV Remotes using a two way wireless channel as part of the pairing process between their set-top boxes and Remotes.

This video covers:

- Unpacking
- Plugging In
- Remote Control Set Up
- Activating Service

<https://www.youtube.com/watch?v=r2rbXaFX1XM&feature=youtu.be>.



Your Xfinity remote can be paired with Xfinity X1 TV Boxes, allowing you to control the TV Box even when it is placed out of sight, such as in an entertainment center or in another room (up to 50 feet away). Xfinity remotes can be identified by the model number on the back panel or within the battery compartment of the remote.

Note: Once your remote is successfully paired with a TV Box, it will not control any other TV Box until paired with the other TV Box. Xfinity remotes can only be paired with one TV Box at a time.

<https://www.xfinity.com/support/articles/remote-program-the-xr2-or-xr5-to-aim-anywhere>.

220. In a second example, a home device such as a camera is a controllable device. The Xfinity XR11/XR15 remote or smartphone running the Xfinity App is the control device. The camera is paired to the XR11/XR15 remote or smartphone running the Xfinity App through the wireless gateways. As part of the pairing process, the camera sends a signal with its ID to the wireless gateways using a two-way wireless channel which is connected to the set-top box and paired Remote. Xfinity explained that Home Devices, such as alarms, can be controlled using five different ways:

Five ways to manage your system at home and on the go

With Xfinity Home, you can access your system from anywhere, on any device. Use any of the methods on this page to **arm/disarm** your system, **monitor system status**, **review the latest activity** and **view live video**.



1. Xfinity Home app

Download the Xfinity Home app to access your system on your mobile device and customize rules.

- The app will ask for permission to add the Xfinity Home SMS and Professional Monitoring Station phone numbers as contacts to your device. This allows your device to quickly identify text messages from Xfinity Home if your security alarm goes off or there is an important message. Tap **OK**.
- Once the app is installed, sign in using your Xfinity username and password and set up Touch ID or Fingerprint ID, if applicable.

2. Xfinity X1

If you subscribe to X1, you can use the Xfinity Home app on your TV to control your system from the comfort of your couch. The X1 Voice Remote allows you to access your system using your voice!

Just say "Xfinity Home Arm Stay" or "Xfinity Home Cameras"



4 Xfinity Home Quick Start Guide



IMPORTANT: Do not unplug or move your Touchscreen Controller from its install location. Doing so may interrupt Professional Monitoring connectivity and service.

3. Touchscreen Controller

This hub is a critical part of your security service. It communicates directly with your devices and with the Professional Monitoring Station, and it allows you to:

- Manage your system settings
- Personalize Keypad Codes for family, friends and anyone who needs access to your home
- View the weather
- Send an emergency alarm

4. Online Subscriber Portal

Log in to the Subscriber Portal to manage your system and account settings in greater detail from your computer:

- Update emergency contacts
- Personalize Keypad Codes for family, friends and anyone who needs access to your home
- Update your alarm permit number (if applicable)

Log in now at xfinity.com/XfinityHomeLogin

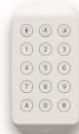

5. Wireless Keypad

This device can live anywhere in your home and allows you to arm/disarm your system.

Xfinity Home Quick Start Guide 5

https://www.xfinity.com/support/pdfs/articles/xhs_english_welcome_guide_qsg_518.pdf

221. For example, a camera can pair to a smartphone using an Xfinity wireless gateway.

Pairing and Installing a Camera

Did You Know? You can only pair one Camera at a time. If you have multiple Cameras, you'll need to pair each Camera individually using the power adapter it came with. Please do not try to pair multiple Cameras to a single power adapter.

1. [Sign in](#) to the Xfinity Home app for mobile devices.
2. The first screen you see depends on whether you have previously installed a Camera or another Xfinity Home device, and the type of mobile device you're using.
 - If you haven't installed an Xfinity Home device, you'll see a welcome screen. Tap **Add a Device**.
 - If you already have Xfinity Home devices and are using an Android mobile device, you'll see the **Overview** screen. Tap the **More** icon (three vertical dots), then tap **Add Device**.
 - If you already have Xfinity Home devices and are using an Apple mobile device, you'll see the **Overview** screen. Tap the **More** icon, then tap **Add a Device**.
3. On the **Add a Device** screen, tap **XFINITY Home Camera**.

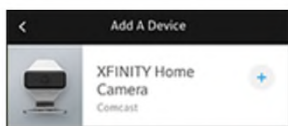

Did You Know? You can also use the Xfinity Home app to connect [Works with Xfinity](#).

<https://www.xfinity.com/support/articles/pair-install-xcam-home-mobile-app>.

222. The camera sends an enrollment signal that is searched for during the pairing process.

11. Wait for the system to find your Camera, which can take up to five minutes.

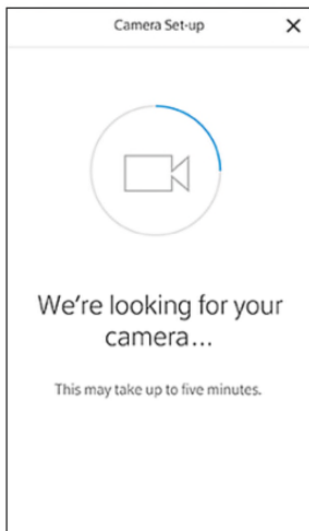

<https://www.xfinity.com/support/articles/pair-install-xcam-home-mobile-app>.

223. The set-top boxes and home devices must be registered/activated with Defendant’s Cloud using their device identifiers (e.g., Host ID, Data, and Unit Address) which are used by Defendant’s Cloud (including cached databases) to identify the service permitted, including controllable functions and corresponding command strings to control the functions of the set-top boxes. The set-top boxes can include the X1 or third party set-top boxes may be used.

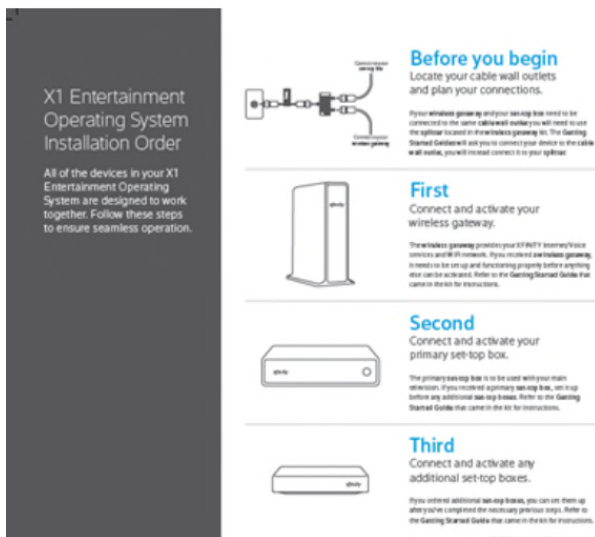

<https://www.xfinity.com/support/articles/what-is-included-in-an-x1-self-install-kit>.

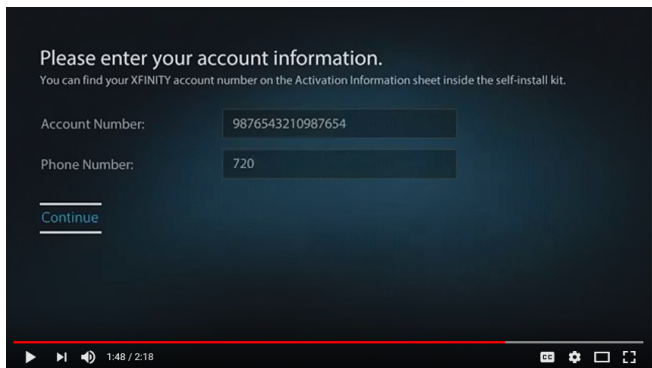

<https://www.youtube.com/watch?v=r2rbXaFX1XM&feature=youtu.be>.

Pair or Activate Your CableCARD - Self-Installation Setup

This article lists the steps to pair or activate your CableCARD.

For more information and frequently asked questions about CableCARDS, see [What is a CableCARD?](#). For details on how you can get a CableCARD to activate your Xfinity TV service on CableCARD-compatible retail devices, see [How to Get a CableCARD](#).

CableCARD Self Install Setup Instructions

To complete activation, the CableCARD will need to be paired to your new device. In order to pair the CableCARD to your device and activate Xfinity TV services, you will need the following information:

- Device Host ID
- Device Data ID (in some setups)
- CableCARD ID

If you are pairing your CableCARD to a TiVo or Ceton device, see the following for specific pairing instructions:

<https://www.xfinity.com/support/articles/pair-activate-cablecard>.

Set Up a New X1 TV Box

If a new TV Box is detected on your account, it will be displayed with **NEW** notation in the **XFINITY TV** screen. Tap anywhere in the area with **NEW** notation and it will take you to the **TV Device** screen.

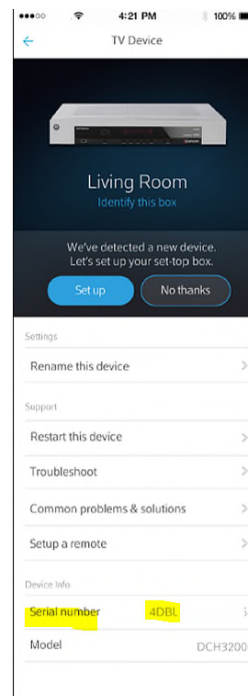
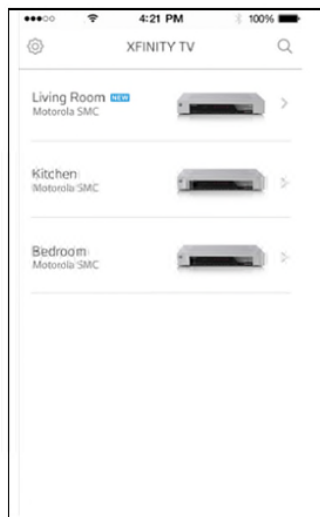

<https://www.xfinity.com/support/articles/my-account-app-new-set-top-box-or-wireless-gateway>.

224. Once the activation/pairing process for the set-top boxes or home devices (such as alarms and cameras) is complete, the set-top boxes and home devices can be named as part of the registration process (e.g., Living Room DVR or Front Door camera).

14. Enter a name that identifies the Camera's intended location, such as "First Floor," then tap **Continue**.

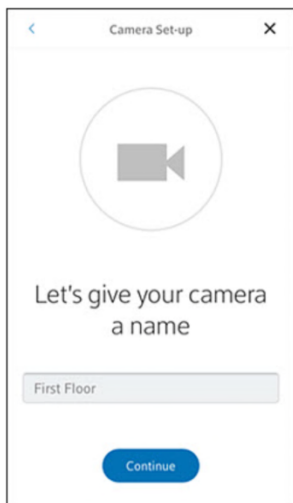

<https://www.xfinity.com/support/articles/pair-install-xcam-home-mobile-app>.

225. As part of the process, the set-top boxes and home devices (such as alarms and cameras) are added to customers' accounts, which include all related information such as the customers' other registered set-top boxes, wireless gateways, and smartphones.

226. Xfinity set-top boxes and home devices can be controlled by a TV Remote (second control device) once paired.

227. To complete the pairing process between the set top boxes and TV Remote, the TV Remote sends a second enrollment signal (e.g., triggered by entering a 3 digit confirmation code) to complete the pairing process. The TV Remote is then paired to the first control device.



<https://www.xfinity.com/support/articles/pair-wireless-tv-box-to-xfinity-in-home-network>

228. In another example, an alarm or camera (first controllable device) can be paired with a TV XR11/XR15 remote and set-top boxes (second control device) functioning with wireless gateways. Further, the TV XR11/XR15 remote and set-top boxes are paired together and the set-top boxes and wireless gateways are paired with each other. All of these devices are also associated with the customer's account in Defendant's Cloud:

Pair Your Wireless X1 TV Box to Your Xfinity In-Home Network

This article provides instructions on pairing an X1 Wireless TV Box (Xi5 or Xi6) to your Xfinity in-home network.

Note: You can also connect your X1 Wireless TV Box to your xFi Gateway (Arris XB3 TG1682G, Arris XB6 TG3482G, Cisco 3941T or Technicolor XB6 CGM4140COM) with RDK-B via an Ethernet cable, in which case these pairing steps will not be necessary.

<https://www.xfinity.com/support/articles/pair-wireless-tv-box-to-xfinity-in-home-network>



The following audio will play when the pairing screen comes up:

"Let's start by pairing your set top box with your Wireless Gateway. Step 1: Press the WPS button on the bottom edge of your set top box. Step 2: Within 2 minutes press the WPS button located on the top edge of your Wireless Gateway. Setup will continue automatically after pairing is complete."

<https://www.xfinity.com/support/articles/pair-wireless-tv-box-to-xfinity-in-home-network>

229. The control devices are registered with Defendant's Cloud using their device identifiers which are compared to a database to determine the type of devices that a customer has and their functionality, including control commands that they produce in response to user operations. When a customer sets up a new wireless gateway or set-top box the user must both (i) register the device and (ii) must select the type of remote that they have:

Set up a New Wireless Gateway or X1 TV Box with the Xfinity My Account App

This article provides instructions on how to set up a new wireless gateway or Xfinity X1 TV Box using the Xfinity My Account app.

Set Up a New Wireless Gateway

If a new wireless gateway is detected on your account, the device will be displayed with **NEW** notation next to new WiFi network name (SSID) in the **XFINITY Internet** tab. Tap anywhere in the area with **NEW** notation and it will take you to the **Internet Device** screen.

<https://www.xfinity.com/support/articles/my-account-app-new-set-top-box-or-wireless-gateway>

Set Up a New X1 TV Box

If a new TV Box is detected on your account, it will be displayed with **NEW** notation in the **XFINITY TV** screen. Tap anywhere in the area with **NEW** notation and it will take you to the **TV Device** screen.

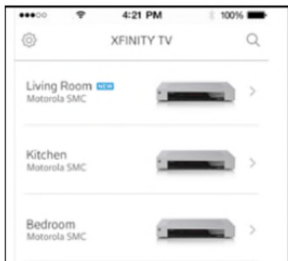

You will then be prompted to select your Xfinity remote model and follow the on-screen instructions.



<https://www.xfinity.com/support/articles/my-account-app-new-set-top-box-or-wireless-gateway>.

230. Upon activation, a dedication command is sent to a first controllable device (e.g., set-top boxes and alarms or cameras), handheld concierge device (e.g., the smartphone), control gateways, and second control device (e.g., XR11/XR15 remote). This process is completed by pairing and registering the various devices with a customer's account. As a

result, a customer's operation of the second control device (e.g., XR11/XR15 remote) is dedicated to controlling at least some of the controllable functions of the set-top boxes and media server (or other home devices) by causing the command strings to be sent to the first controllable device (e.g., set-top boxes and media servers) by the gateways (e.g., wireless gateways and Defendant's Cloud).

231. The remote (second control device) can control some of the controllable functions (change channel) of the set-top boxes and media server (first controllable device) by causing the command strings to be sent to the set-top boxes and media server to play back streaming/on-demand videos.

232. Additionally, once a home device (such as a security camera) is paired, a remote control or smartphone working with the set-top boxes, gateways and Defendant's Cloud, can be used to control the home device (e.g., turning a security camera on/off or viewing the camera stream on a TV or smartphone).

233. The smartphone (a concierge device) can replicate controls provided by the XR11/XR15 remote or home device controller. The smartphone sends the command strings through the gateways to operate camera, lights, locks and thermostats.

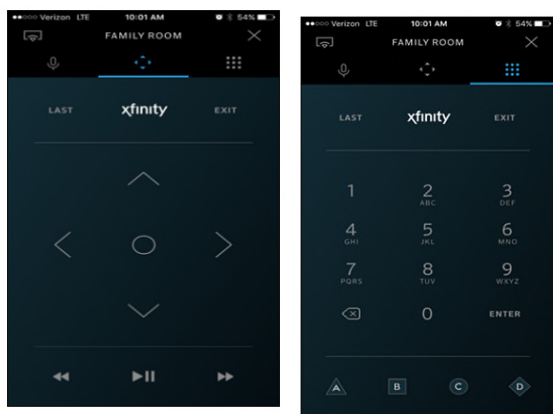

<https://www.xfinity.com/support/articles/setting-up-the-cable-tv-app>

234. Command strings, such as playing a video-on-demand or a show recorded using a networked DVRs, are sent from the XR11/XR15 remote to the set-top boxes and media server by the control gateways. Further, a smartphone using the Xfinity Home App can send command strings through the control gateways to controllable devices. The smartphone can control cameras, lights, and thermostats by wirelessly sending commands through a gateway to the home devices.

The **Dashboard** screen shows your system's current armed status and lists the types of devices installed in your system. From here, you can:

- View live video from [Cameras](#).
- Turn devices on and off and view detailed [device information](#).

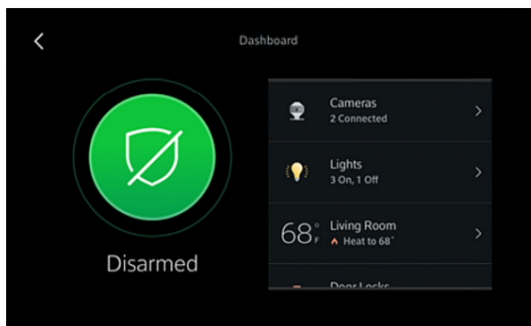

<https://www.xfinity.com/support/articles/touchscreen-getting-started-unified>.

235. Defendant's infringement of the '964 Patent injured and is injuring NexStep in an amount to be proven at trial, but not less than a reasonable royalty.

236. Defendant has been long-aware of NexStep's patented technology, and continues its unauthorized infringing activity despite this knowledge. As discussed above, NexStep actively and diligently attempted to engage in good faith negotiations with Defendant. After being shown NexStep's patented technology in 2007, including the technology covered in the '964 Patent, on information and belief, Defendant copied this technology and made no effort to

avoid infringement when it later launched its initial Xfinity Internet, video (TV), and voice services on or about 2010. Instead, Defendant continued to incorporate NexStep's technology into additional products, such as those identified in this complaint, including remote control devices with voice activated controls. All of these actions demonstrate Defendant's willful, blatant and egregious disregard for NexStep's patent rights.

237. Despite its knowledge of NexStep's patented technology and its specific knowledge of its own infringement, Defendant continued to sell the Accused Products in complete and reckless disregard of NexStep's patent rights. As such, Defendant acted recklessly, willfully, wantonly, and deliberately engaged in acts of infringement of the '964 Patent, justifying an award to NexStep of increased damages under 35 U.S.C. § 284, and attorneys' fees and costs incurred under 35 U.S.C. § 285.

COUNT XVI

(Indirect Infringement of the '964 Patent pursuant to 35 U.S.C. § 271(b))

238. NexStep repeats, realleges, and incorporates by reference, as if fully set forth herein, the allegations of the preceding paragraphs, as set forth above.

239. As discussed above, Defendant knew about NexStep's patented technology, including the '964 Patent, by at least 2007.

240. In addition to directly infringing the '964 Patent, Defendant knew or was willfully blind to the fact that it was inducing infringement of at least Claim 11 the '964 Patent under 35 U.S.C. § 271(b) by instructing, directing and requiring third parties (e.g., customers) to use, combine the components of the system claims and perform the steps of the method claims of the '964 Patent, either literally or under the doctrine of equivalents.

241. Defendant knowingly and actively aided and abetted the direct infringement of the '964 Patent by instructing and encouraging its customers and developers to use the '964

Accused Products. Such instructions and encouragement included advising third parties to use the '964 Accused Products in an infringing manner, providing a mechanism through which third parties may infringe the '964 Patent, advertising and promoting the use of the '964 Accused Products in an infringing manner, and distributing guidelines and instructions to third parties on how to use the '964 Accused Products in an infringing manner.

COUNT XVII

(Direct Infringement of the '697 Patent pursuant to 35 U.S.C. § 271(a))

242. NexStep repeats, realleges, and incorporates by reference, as if fully set forth herein, the allegations of the preceding paragraphs, as set forth above.

243. Defendant infringes at least Claim 11 of the '697 Patent in violation of 35 U.S.C. § 271(a).

244. Defendant's infringement is based upon literal infringement or, in the alternative, infringement under the doctrine of equivalents.

245. Defendant's acts of making, using, importing, selling, and offering for sale infringing products and services were without the permission, consent, authorization, or license of NexStep.

246. Defendant's infringement includes the manufacture, use, sale, importation and offer for sale of Defendant's Xfinity Services, including equipment to make and use the Xfinity Services (collectively, the "'697 Accused Products").

247. The '697 Accused Products infringe the '697 Patent because Defendant provides Xfinity Apps installed in persistent memory on smartphones to provide customer support and diagnostics and induce customers to do the same.

248. To the extent the '697 Accused Products include hardware or software owned by third parties, the '697 Accused Products still infringe the '697 Patent because Defendant is

vicariously liable for the manufacture and use of the patented system by controlling the entire system and deriving a benefit from the use of every element of the entire system. Similarly, to the extent Defendant's third parties (e.g., customers) form the '697 Accused Products or use their own equipment to form the '697 Accused Products, including performance of one or more patented steps, Defendant still infringes the '697 Patent because third parties' beneficial use of the '697 Accused Products is conditioned on combining the components and performing one or more steps of the methods in an infringing manner as established by Defendant.

249. Defendant sells smartphones, software, and other equipment with instructions and users guides, to use its Xfinity Services, including Xfinity Apps.

<https://www.xfinity.com/mobile/shop?category=device>.

250. The '697 Accused Products, including Xfinity Apps such as TV Remote, Stream, Connect, xFi, and Home apps, infringe the '697 Patent because they provide systems and methods that allow customers to control set-top boxes, DVRs, VoD, and operate home security devices, among other features provided by Xfinity Apps described above.

251. When computer instructions are executed on one or more processors of a handheld concierge device (e.g., smartphone) and control gateways (e.g., xFi Wireless Gateway and Defendant's Cloud), they cause a device (e.g., set-top boxes working with Comcast media servers, cameras, lights, outlets and thermostats) to provide diagnostic information.

252. Smartphones sold by Defendant running the Xfinity Apps, such as My Account App, provide Defendant's customers a method to access their accounts, pay their bills, troubleshoot hardware and software issues, contact Defendant, and schedule service visits or customer support calls.

15 million customers are now using My Account!

- Pay their bill or manage bill settings
- Troubleshoot their equipment
- Manage home Wi-Fi
- Store a new payment method
- Edit personal contact information
- Set up a remote
- Check for a Wi-Fi hotspot
- Scan a new credit card
- Pay with Apple Pay
- Add or remove devices in their home

<https://www.youtube.com/watch?v=WdaMJy1nSQw>.

253. The Xfinity My Account App can be accessed through mobile phones (e.g., using cellular and Wi-Fi communications), on the Internet or through the Xfinity X1 set top boxes. It can be downloaded from an app store (Apple iTunes or Google Play) and links can be found on Defendant’s web pages, instructions and marketing materials.

Access from Settings

Press **MENU** on your remote, and select the **Settings** icon.

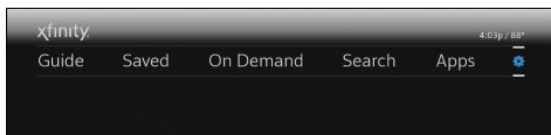

My Account will be the first option listed. Press the **OK** button.

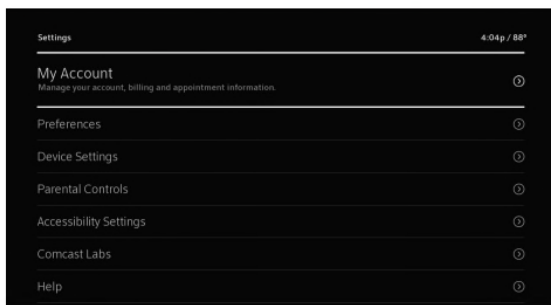

Access from Apps Menu

The icon for the Xfinity My Account app appears in the **XFINITY** section of the **Apps** menu. Highlight the app tile and press **OK** on your remote control.

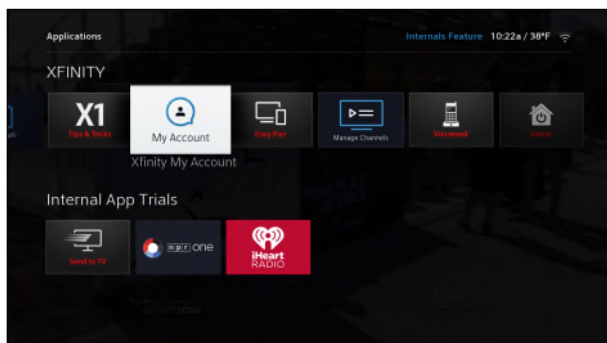

<https://www.xfinity.com/support/articles/using-the-my-account-app>.

254. A smartphone device sold by Defendant running the Xfinity Apps acts as a concierge device, allowing users to access options/information relating to their account, TV, Internet or voice services, users can tell the app which services or devices are having problems. Once a device is selected, the app will allow the user to access troubleshooting guides as well as “Common Problems & Solutions” which are customized to the consumers’ devices:

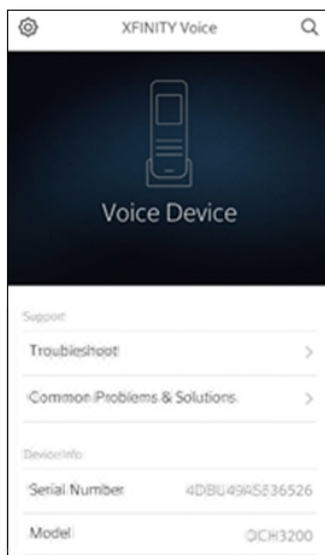
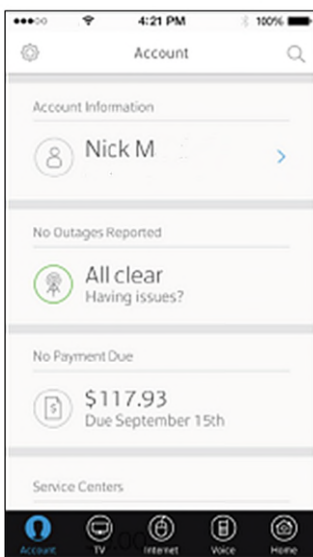

<https://www.xfinity.com/support/articles/my-account-app-mobile-sign-in>;
<https://www.xfinity.com/support/articles/my-account-app-voice-mobile-troubleshooting>.

255. A smartphone device sold by Defendant running the Xfinity Apps can, with a single click on the smartphone, communicate with the Xfinity X1 set top boxes working Defendant’s Cloud, and provide users with support relating to their individual products and services.

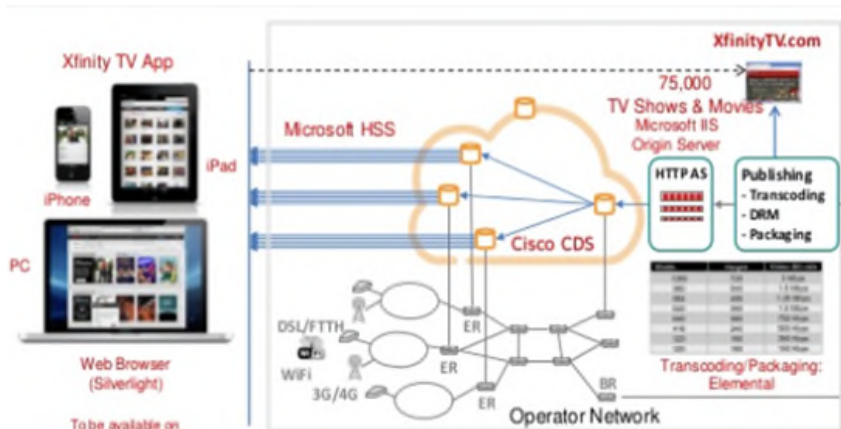

Ex. 16; <https://itunes.apple.com/us/app/xfinity-my-account/id776010987?mt=8>.

256. A smartphone device sold by Defendant running the Xfinity Apps can be used to choose which device is in need of service or repair and can communicate with the home gateways (e.g., xFi Wireless Gateway and Defendant’s Cloud) via the My Account App.

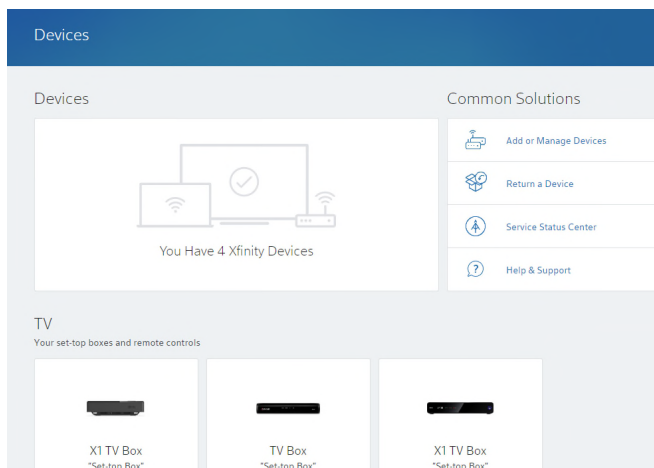

<https://customer.xfinity.com/#/devices>.

257. Smartphone devices sold by Defendant running the Xfinity Apps (e.g., My Account app) provide customers with a system for pulling information, guides, and automated troubleshooting steps relating to that device with one click.

258. A smartphone device sold by Defendant running the Xfinity Apps can select a device and cause the home gateways (e.g., xFi Wireless Gateway and Defendant's Cloud) to initiate a support session which can take the form of step-by-step tutorials, diagnostics or scheduling of a call with a live service representative. The app launches an automated protocol regarding how to fix certain issues with that specific product or service.

259. If the automated support protocol does not resolve the user's issues, he or she may schedule a call with a customer support representative at a time of the user's choosing, allowing the user to avoid automated attendants or interactive voice recognition systems:

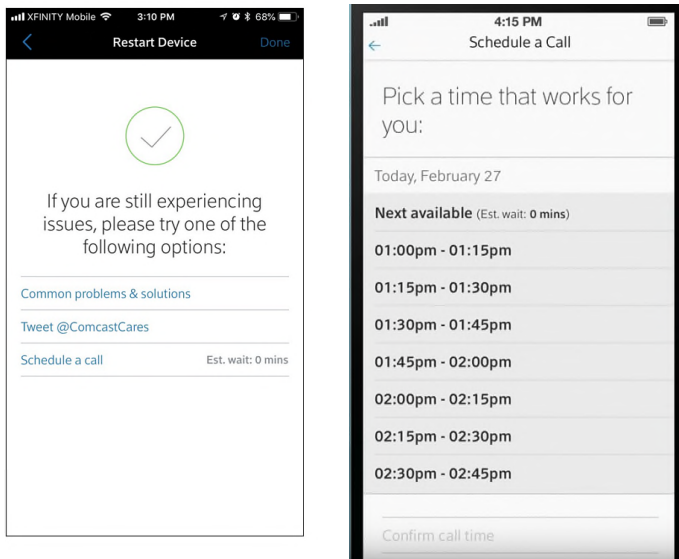

[https://www.xfinity.com/support/articles/my-account-app-internet-mobile-troubleshooting;](https://www.xfinity.com/support/articles/my-account-app-internet-mobile-troubleshooting)
[https://www.youtube.com/watch?v=WdaMJy1nSQw.](https://www.youtube.com/watch?v=WdaMJy1nSQw)

260. A smartphone captures a user's voice and allows for two-way audio while the diagnostic information is relayed to Defendant.

261. Defendant's infringement of the '697 Patent injured and is injuring NexStep in an amount to be proven at trial, but not less than a reasonable royalty.

262. Defendant has been long-aware of NexStep's patented technology, and continues its unauthorized infringing activity despite this knowledge. As discussed above, NexStep actively and diligently attempted to engage in good faith negotiations with Defendant. After being shown NexStep's patented technology in 2007, including the technology covered in the '697 Patent, on information and belief, Defendant copied this technology and made no effort to avoid infringement when it later launched its initial Xfinity Internet, video (TV), and voice services on or about 2010. Instead, Defendant continued to incorporate NexStep's technology into additional products, such as those identified in this complaint, including remote control devices with voice activated controls. All of these actions demonstrate Defendant's willful, blatant and egregious disregard for NexStep's patent rights.

263. Despite its knowledge of NexStep's patented technology and its specific knowledge of its own infringement, Defendant continued to sell the Accused Products in complete and reckless disregard of NexStep's patent rights. As such, Defendant acted recklessly, willfully, wantonly, and deliberately engaged in acts of infringement of the '697 Patent, justifying an award to NexStep of increased damages under 35 U.S.C. § 284, and attorneys' fees and costs incurred under 35 U.S.C. § 285.

COUNT XVIII

(Indirect Infringement of the '697 Patent pursuant to 35 U.S.C. § 271(b))

264. NexStep repeats, realleges, and incorporates by reference, as if fully set forth herein, the allegations of the preceding paragraphs, as set forth above.

265. As discussed above, Defendant knew about NexStep's patented technology, including the '697 Patent, by at least 2007.

266. In addition to directly infringing the '697 Patent, Defendant knew or was willfully blind to the fact that it was inducing infringement of at least Claim 11 the '697 Patent under 35 U.S.C. § 271(b) by instructing, directing and requiring third parties (e.g., customers) to use, combine the components of the system claims and perform the steps of the method claims of the '697 Patent, either literally or under the doctrine of equivalents.

267. Defendant knowingly and actively aided and abetted the direct infringement of the '697 Patent by instructing and encouraging its customers and developers to use the '697 Accused Products. Such instructions and encouragement included advising third parties to use the '697 Accused Products in an infringing manner, providing a mechanism through which third parties may infringe the '697 Patent, advertising and promoting the use of the '697 Accused Products in an infringing manner, and distributing guidelines and instructions to third parties on how to use the '697 Accused Products in an infringing manner.

PRAYER FOR RELIEF

WHEREFORE, NexStep prays for judgment and relief as follows:

A. an entry of judgment holding that Defendant infringed, is infringing, induced, and is inducing infringement of the Asserted Patents;

B. a preliminary and permanent injunction against Defendant and its officers, employees, agents, servants, attorneys, instrumentalities, and those in privity with them, from infringing and inducing infringement of the Asserted Patents, and for all further and proper injunctive relief pursuant to 35 U.S.C. § 283;

C. an award to NexStep of such past damages, not less than a reasonable royalty, as it shall prove at trial against Defendant that is adequate to fully compensate NexStep for Defendant's infringement of the Asserted Patents;

D. a determination that Defendant’s infringement has been willful, wanton, and deliberate and that the damages against it be increased up to treble on this basis or for any other basis in accordance with the law;

E. a finding that this case is “exceptional” and an award to NexStep of its costs and reasonable attorneys’ fees, as provided by 35 U.S.C. § 285;

F. an accounting of all infringing sales and revenues, together with post-judgment interest and pre-judgment interest from the first date of infringement of the Asserted Patents; and

G. such further and other relief as the Court may deem proper and just.

DEMAND FOR JURY TRIAL

NexStep demands a jury trial on all issues so triable.

POTTER ANDERSON & CORROON LLP

OF COUNSEL:

Paul J. Andre
Lisa Kobialka
KRAMER LEVIN NAFTALIS
& FRANKEL LLP
990 Marsh Road
Menlo Park, CA 94025
(650) 752-1700

Jonathan S. Caplan
Aaron M. Frankel
Marcus A. Colucci
KRAMER LEVIN NAFTALIS
& FRANKEL LLP
1177 Avenue of the Americas
New York, NY 10036
(212) 715-9100

Dated: June 3, 2019
6233158/49148

By: /s/ Philip A. Rovner
Philip A. Rovner (#3215)
Jonathan A. Choa (#5319)
Hercules Plaza
P.O. Box 951
Wilmington, DE 19899
(302) 984-6000
provner@potteranderson.com
jchoa@potteranderson.com

*Attorneys for Plaintiff
NexStep, Inc.*