

**IN THE UNITED STATES DISTRICT COURT
FOR THE EASTERN DISTRICT OF TEXAS
MARSHALL DIVISION**

UNILOC 2017 LLC

Plaintiff,

v.

GOOGLE LLC,

Defendant.

§
§ CIVIL ACTION NO. 2:18-cv-00551
§
§
§ PATENT CASE
§
§
§ JURY TRIAL DEMANDED
§

ORIGINAL COMPLAINT FOR PATENT INFRINGEMENT

Plaintiff Uniloc 2017 LLC (“Uniloc”), as and for their complaint against defendant Google LLC (“Google”) allege as follows:

THE PARTIES

1. Uniloc is a Delaware limited liability company having places of business at 620 Newport Center Drive, Newport Beach, California 92660 and 102 N. College Avenue, Suite 303, Tyler, Texas 75702.
2. Uniloc holds all substantial rights, title and interest in and to the asserted patent.
3. On information and belief, Google, a Delaware corporation with its principal office at 1600 Amphitheatre Parkway, Mountain View, CA 94043. Google offers its products and/or services, including those accused herein of infringement, to customers and potential customers located in Texas and in the judicial Eastern District of Texas.

JURISDICTION

4. Uniloc brings this action for patent infringement under the patent laws of the United States, 35 U.S.C. § 271 *et seq.* This Court has subject matter jurisdiction pursuant to 28 U.S.C. §§ 1331 and 1338(a).

5. This Court has personal jurisdiction over Google in this action because Google has committed acts within the Eastern District of Texas giving rise to this action and has established minimum contacts with this forum such that the exercise of jurisdiction over Google would not offend traditional notions of fair play and substantial justice. Google has committed and continues to commit acts of infringement in this District by, among other things, offering to sell and selling products and/or services that infringe the asserted patent.

6. Venue is proper in this Court pursuant to 28 U.S.C. §§ 1391 and 1400(b). Google is registered to do business in Texas, and upon information and belief, Google has transacted business in the Eastern District of Texas and has committed acts of direct and indirect infringement in the Eastern District of Texas. Google has a regular and established place of business in this District, as set forth below.

7. Google is a multinational technology company that collects, stores, organizes, and distributes data. In addition to its service model for distribution of data (e.g., movies, search results, maps, music, etc.), Google has an expansive regime that gathers data on residents of this District through the hardware devices it sells (e.g., phones, tablets, and home audio devices) and, also, through the operating systems and apps it provides. As an example, Google gathers data when a resident runs its operating systems and apps (e.g., location services).¹ As another example, Google gather's data when a resident interacts with Google's plethora of services such as search, email, and music and movie streaming. See <https://safety.google/privacy/data/> (indicating that Google gathers data from "things you search for," "Videos you watch," "Ads you view or click," "Your location," "Websites you visit," and "Apps, browsers, and devices you use to access Google

¹ See e.g., "AP Exclusive: Google tracks your movements, like it or not," <https://apnews.com/828aefab64d4411bac257a07c1af0ecb/AP-Exclusive:-Google-tracks-your-movements,-like-it-or-not>

services”). As yet another example, Google gathers data by listening and recoding everything a resident says within proximity of one of its products such as Google Home.² Others have reported that Google gathers “where you’ve been,” “everything you’ve ever searched – and deleted,” “all the apps you use,” “all of your YouTube history,” “which events you attended, and when,” “information you deleted [on your computer],” “your workout routine,” “years’ worth of photos,” and “every email you ever sent.”³

8. Google takes these massive amounts of gathered data on residents of this district and monetizes them, for example, through targeted advertising. Some have reported that “creepy” advertisements for items never searched for, but only spoken out loud appeared. *See e.g.,* <https://www.youtube.com/watch?v=zBnDWSvaQII> (conducting test on the term “dog toys” spoken out loud, but never searched; tester claims targeted “dog toy” advertisements only appeared after speaking the phrase out loud).

9. In addition to extensive data gathering of information on residents of this District, Google has a substantial presence in the District directly through the products and services Google provides residents of this District (some of which also gather data).⁴ One of Google’s main businesses in this District is delivering information, including digital content such as movies, music, apps, and advertising.

² *See* <https://www.unilad.co.uk/technology/google-is-listening-to-everything-we-say-and-you-can-hear-it-back/> (“Tech giant and the font of all pub quiz knowledge, Google, can quietly record many of the conversations that people have in close proximity to its products.”).

³ *See* <https://www.theguardian.com/commentisfree/2018/mar/28/all-the-data-facebook-google-has-on-you-privacy>.

⁴ Non-limiting examples include Google Search, Maps, Translate, Chrome Browser, YouTube, YouTube TV, Google Play Music, Chromecast, Google Play Movies and TV, Android Phones, Android Wear, Chromebooks, Android Auto, Gmail, Google Allo, Google Duo, Google+, Google Photos, Google Contacts, Google Calendar, Google Keep, Google Docs, Google Sheets, Google Slides, Google Drive, Google Voice, Google Assistant, Android operating system, Project Fi Wireless phone systems, Google Pixel, Google Home, Google Wifi, Daydream View, Chromecast Ultra.

10. Google describes itself as an “information company.”⁵ Its vision is “to provide access to the world’s information in one click,” and its mission is “to organize the world’s information and make it universally accessible and useful.”⁶ Making information available to people wherever they are and as quickly as possible is critical to Google’s business.

Google Global Cache (GGC)

11. As Google’s CEO, Sundar Pichai, explains, “We want to make sure that no matter who you are or where you are or how advanced the device you are using—Google works for you.”⁷ To meet this goal, Google developed a content delivery network that it calls the Edge Network.

12. One non-limiting example of physical presence in this District is Google’s Edge Network. Google provides web-based services, such as YouTube, YouTube TV, and Google Play, to users throughout the world. These services are in high demand. Google reports that Google Play reaches more than 1 billion Android users and that YouTube serves over 1.8 billion users per month.⁸ Studies show that YouTube alone is responsible for approximately 20% of all internet traffic.⁹ YouTube TV, which has been described as an “add-on to YouTube” allows Google to essentially become the local TV provider for residents of this District. For example, residents in this District obtain local Dallas-Fort Worth area channels such as WFAA, ABC (Channel 8); CBS (Channel 11); NBC (Channel 5); and Fox (Channel 4).¹⁰

⁵ See “This Year’s Founder’s Letter” by Alphabet CEO, Sundar Pichai, <https://blog.google/inside-google/alphabet/this-years-founders-letter/>.

⁶ <http://panmore.com/google-vision-statement-mission-statement>.

⁷ See e.g., <http://time.com/4311233/google-ceo-sundar-pichai-letter/>.

⁸ See <https://www.theverge.com/2018/5/3/17317274/youtube-1-8-billion-logged-in-monthly-users-brandcast-2018>

⁹ See <https://www.sandvine.com/hubfs/downloads/archive/2016-global-internet-phenomena-report-latin-america-and-north-america.pdf> and <http://testinternetspeed.org/blog/half-of-all-internet-traffic-goes-to-netflix-and-youtube/>

¹⁰ See, e.g. <https://support.google.com/youtubetv/answer/7068923?hl=en> and https://support.google.com/youtubetv/answer/7370552?hl=en&ref_topic=7071745.

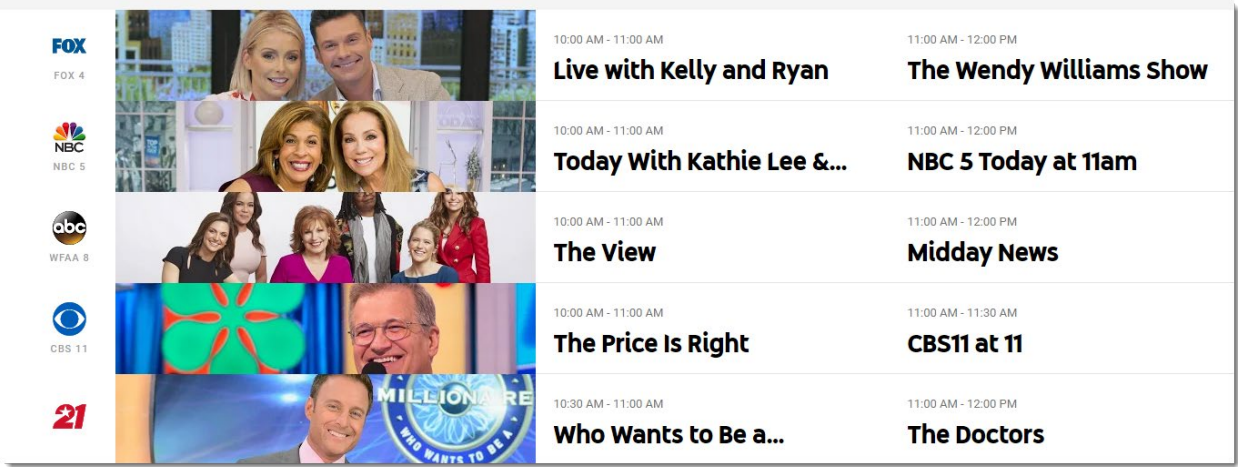

Source: <https://tv.youtube.com/live> (as accessed from this District).

To verify a resident should receive such local channels, Google verifies a location of such resident.

13. Google’s Edge Network, itself, has three elements: Core Data Centers, Edge Points of Presence, and Edge Nodes. The Core Data Centers (there are eight in the United States) are used for computation and backend storage. Edge Points of Presence are the middle tier of the Edge Network and connect the Data Centers to the internet. Edge Nodes are the layer of the network closest to users. Popular content, including YouTube TV, YouTube, video advertising, music, mobile apps, and other digital content from the Google Play store, is cached on the Edge Nodes, which Google refers to as Google Global Cache or “GGC”.

14. Google Global Cache is recognized as “one of Google’s most important pieces of infrastructure,”¹¹ and Google uses it to conduct the business of providing access to the world’s information. GGC servers in the Edge Nodes function as local data warehouses, much like a shoe manufacturer might have warehouses around the country. Instead of requiring people to obtain information from distant Core Data Centers, which would introduce delay, Google stores information in the local GGC servers to provide quick access to the data.

¹¹ <http://blog.speedchecker.xyz/2015/11/30/demystifying-google-global-cache/>.

15. Caching and localization are vital for Google's optimization of network resources. Because hosting all content everywhere is inefficient, it makes sense to cache popular content and serve it locally. Doing so brings delivery costs down for Google, network operators, and internet service providers. Storing content locally also allows it to be delivered more quickly, which improves user experience. Serving content from the edge of the network closer to the user improves performance and user happiness. To achieve these benefits, Google has placed Edge Nodes throughout the United States, including in this District. Google describes these nodes as the workhorses of video delivery.

16. Just like brick-and-mortar stores, Google's GGC servers independently determine what content to cache based on local requests. The GGC servers in Google's Edge Nodes include software that Google refers to as "µstreamer." µstreamer is responsible for serving video content from YouTube and other Google services, along with other large content such as Google Play applications and Chrome downloads. It operates on a content-delivery platform at the edge of Google's network called "bandaid"; it does not run in the core (except for some internal testing purposes), unlike the majority of the Google services, such as search or gmail.

17. Using µstreamer and bandaid, a GGC server handles requests directly from its clients, predominantly YouTube's video players. When such a request is received, if the content is stored in the node's local cache, the node will serve it to the end user, improving the user experience and saving bandwidth. If cache-eligible content is not already stored on the node, and the content is cache-eligible, the node will retrieve it from Google, serve it to the user, and store it for future requests.

18. µstreamer is largely autonomous, in the sense that almost all decisions related to serving a particular request are made locally, without coordinating with other servers. Like a brick-and-mortar store sells directly to customers from inventory and stocks that inventory based

on local customer demand, μstreamer in each GGC node decides—independently from other nodes in Google’s Edge Network— whether to serve requested content, whether to cache content, and whether to send requests to other servers.

19. Google’s GGC servers are housed in spaces in the District leased by Google. Google’s GGC servers are housed in spaces leased by Google from Internet Service Providers (ISPs) whose networks have substantial traffic to Google and are interested in saving bandwidth. Hosting Google servers allows ISPs to save both bandwidth and costs, as they do not incur the expense of carrying traffic across their peering and/or transit links.

20. When an ISP agrees to host a GGC server, the parties enter into a Global Cache Service Agreement, under which Google provides:

- hardware and software— including GGC servers and software—to be housed in the host’s facilities;
- technical support; service management of the hardware and software; and
- content distribution services, including content caching and video streaming.

In exchange, the host provides, among other things, a physical building, rack space where Google’s computer hardware is mounted, power, and network interfaces. All ownership rights, title, and intellectual property rights in and to the equipment (i.e., the hardware and software provided by Google) remain with Google and/or its licensors.

21. Multiple ISPs hosted GGC servers are in this District. Google provides the location of its GGC servers, namely Sherman, Tyler, and Texarkana.



Edge PoPs



Edge nodes (Google Global Cache, or GGC)

Our edge nodes (called Google Global Cache, or GGC) represent the tier of Google's infrastructure closest to our users. With our edge nodes, network operators and internet service providers deploy Google-supplied servers inside their network.

Static content that is very popular with the local host's user base, including YouTube and Google Play, is temporarily cached on edge nodes. Google's traffic management systems direct user requests to an edge node that will provide the best experience.

In some locations, we also use our edge nodes to support the delivery of other Google services, such as Google Search, by proxying traffic where it will deliver improved end-to-end performance for the end user.



Map of metros where at least one Edge node (GGC) is present.

Source: <https://peering.google.com/#/infrastructure>

22. Suddenlink Communications, for example, is an ISP that hosts six GGC servers in Tyler, Texas.
23. CableOne is an ISP that hosts three GGC servers in Sherman, Texas, and three GGC servers in Texarkana, Texas.
24. Google caches content on these GGC servers located in this District.
25. Google's GGC servers located in this District cache content that includes, among other things: (i) video advertising; (ii) apps; and (iii) digital content from the Google Play store.
26. Google's GGC servers located in this District deliver cached content for the items in the preceding paragraph to residents in this District.
27. Google generates revenue (i) by delivering video advertising, (ii) from apps,

and (iii) from digital content in the Google Play store.

28. Google treats its GGC servers in this District the same as it treats all of its other GGC servers in the United States.

29. The photographs below show Google's GGC servers hosted by Suddenlink and the building where they are located at 322 North Glenwood Boulevard, Tyler, Texas 75702.



Exterior



Interior Rack Spaces



Google GGC Servers

30. Google not only exercises exclusive control over the digital aspects of the GGC, Google, but also exercises exclusive control over the physical server and the physical space within which the server is located and maintained.

31. This District has previously determined that the GGC server itself and the place of the GGC server, both independently and together, meet the statutory requirement of a “physical place.” *See Seven Networks, LLC v. Google, LLC*, Case No. 2:17-cv-00442-JRG (E.D. Tex.)(Jul. 19, 2018) at Page 24.

32. Likewise, this District has determined that GGC servers and their several locations within this District constitute “regular and established place[s] of business” within the meaning of the special patent venue statute *See Seven Networks, LLC v. Google, LLC*, Case No. 2:17-cv-00442-JRG (E.D. Tex.)(Jul. 19, 2018) at page 38.

33. Similarly, this District has determined that the GGC servers and their locations within the various ISPs within this District are “places of Google” sufficient to meet the statutory requirement of § 1400(b). *See Seven Networks, LLC v. Google, LLC*, Case No. 2:17-cv-00442-JRG (E.D. Tex.)(Jul. 19, 2018) at page 41.

Google’s Cell Phone Service (aka Google Fi)

34. Google also provides phone, messaging, and data services in this District from its wireless phone services called Google Fi. Via this Google Fi service, Google provides its customers voice and high-speed data coverage (4G LTE) for cities such as Tyler and Marshall, TX.

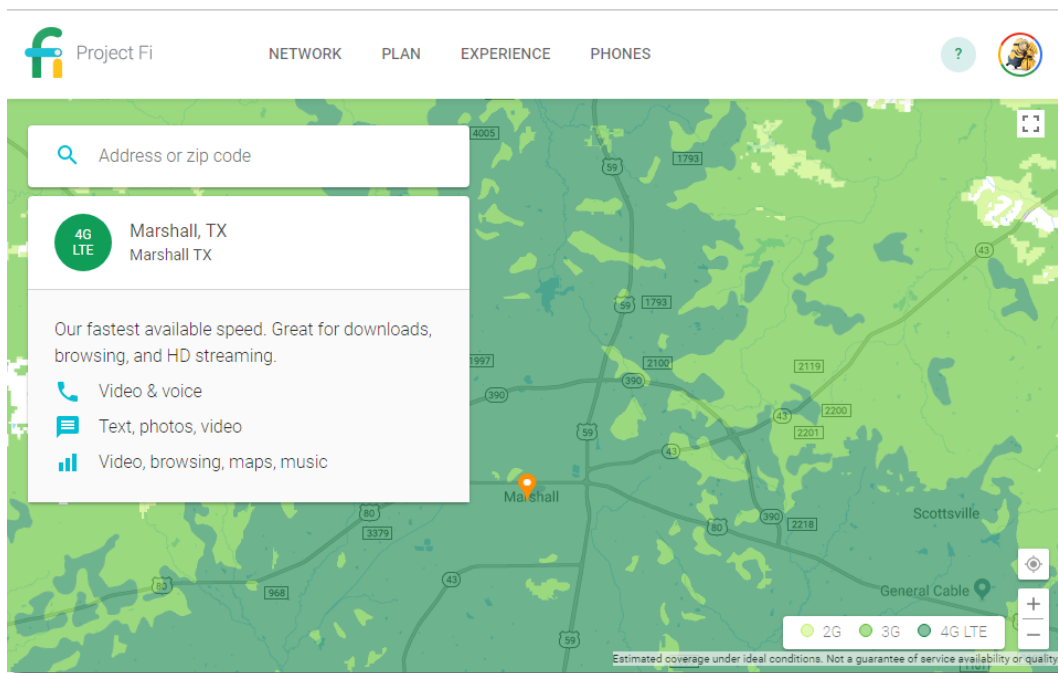

Source: <https://fi.google.com/coverage?q=Marshall%2C%20TX%2C%20USA>

35. The cell towers used for Google’s services are fixed geographical locations. They are “regular” and “established” because they operate in a “steady, uniform, orderly, and methodical manner” and are sufficiently permanent. They are “of the defendant” because Google has contractual and/or property rights to use the cell towers to operate its business. Google also ratifies the service locations through its coverage lookup service.

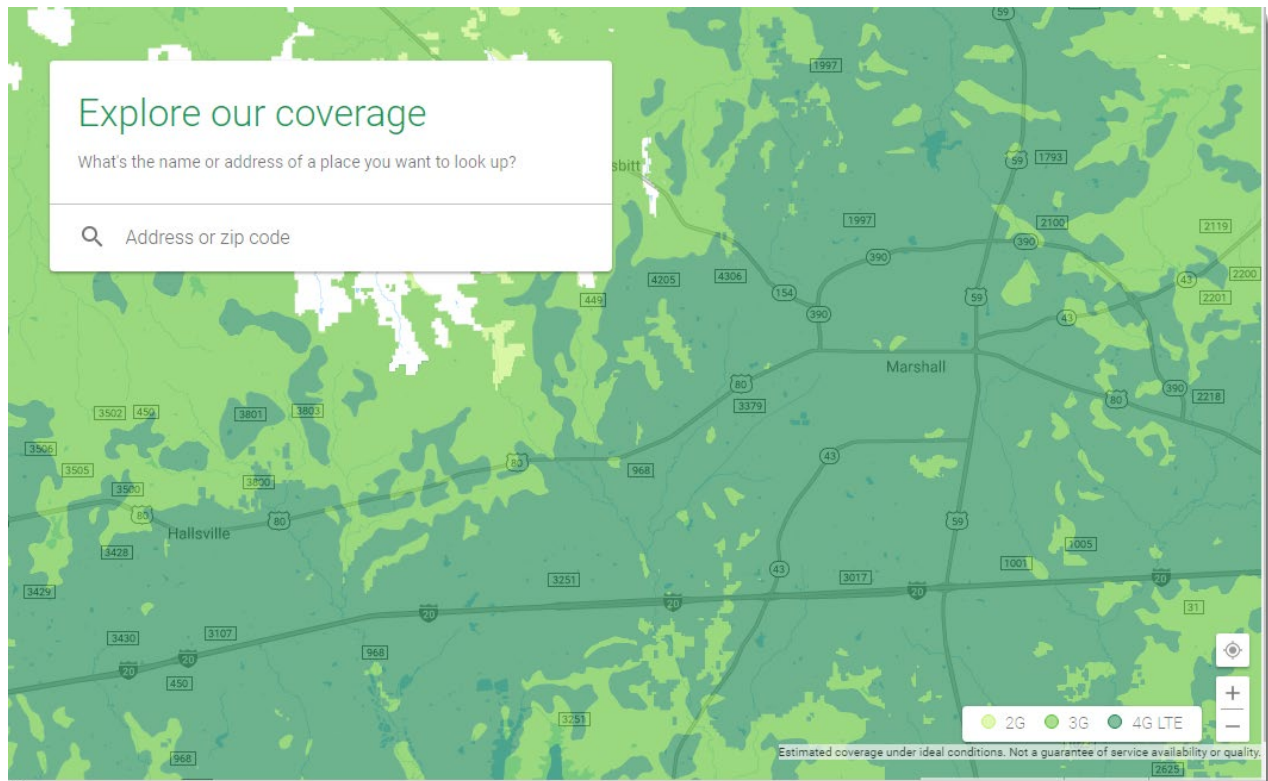



Source: <https://fi.google.com/coverage?>

36. With this coverage lookup service, Google advertises its ability to provide cell coverage in this District and it selected cell towers in and near this District to provide the advertised coverage (e.g., 2G, 3G, or 4GLTE) depending on the location in the District. See <https://fi.google.com/coverage?>. Google is not indifferent to the location of its cell towers. It “established” and “ratified” them where they are for a specific business purpose.

37. Residents of this District also directly contract with and are billed by Google for these services.

Plan Features

All the bells and whistles without the nickels and dimes.

 Calls & texts \$20/mo Unlimited domestic calls and texts with 24/7 support	 Data \$10/GB No charge past 6 GB (for 1 person) with Bill Protection	 Extra people \$15/mo each Add up to 5 more people and share your data plan
---	---	---

Source: <https://fi.google.com/about/plan>

38. Google also determines which cell tower a particular project Fi customer will use while within the District.

✓ What determines when Project Fi moves me between cellular networks?

When multiple carriers are available, Project Fi will move you to the network that our analysis shows will be fastest in your current location, whether that is 4G LTE, 3G, or 2G. We're constantly learning and improving, to account for factors such as newly-built towers or newly-available radio frequencies. And if your current network is providing weak or no coverage, we'll adjust in real time to find you a stronger connection.

Source: <https://fi.google.com/about/faq/#network-and-coverage-4>

Google Cloud Interconnect (GCI) and Direct Peering

39. Google additionally services its customers in this District (and other districts) through yet other facilities it has in this District. More particularly, Google's equipment is located in this District in Denton County Texas at two facilities referred to as "Megaport." At the Megaport facilities in this District, Google offers two services: Google Cloud Interconnect (GCI) and Direct Peering.

40. Google Cloud's Interconnect (GCI) is a service from Google that allows customers to connect to Google Cloud Platform directly as opposed to, for example, over the public network.



Partner Interconnect

You can also extend your data center network into your Google Cloud projects through the service providers you know and love, Partner Interconnect offers enterprise-grade connections similar to Dedicated Interconnect. This solution allows you to add connectivity from your on-premises network to your GCP VPC through one of Google Cloud's many [service provider partners](#).

Partner Interconnect gives you bandwidth options from 50Mbps - 10Gbps allowing you to connect to your VPC and to extend your corporate data center's IP space into the Google cloud by choosing the bandwidth that works best for your needs. This allows you to work with our partners to get similar SLA options as provided by Dedicated Interconnect when you are not able to meet us at one of our dedicated interconnect locations.

Please see the Partner Interconnect [documentation](#) for details on how to create a Partner Interconnect in your GCP Project.

Source: <https://cloud.google.com/interconnect/>

41. Google's Direct Peering services allows its customers to exchange Internet traffic between its customers network and Google's at one of its broad-reaching Edge network locations such as the one at Megaport.

Direct Peering



[SEND FEEDBACK](#)

Connect your business network directly to Google at any of 100+ locations in 33 countries around the world and exchange high throughput cloud traffic.

What is direct peering?

Google allows you to establish a direct [peering](#) connection between your business network and Google's. With this connection you will be able to exchange Internet traffic between your network and Google's at one of our broad-reaching Edge network locations. Visit [Google's peering site](#) to find out more information about edge locations.

Direct peering with Google is done by exchanging BGP routes between Google and the peering entity. After a direct peering connection is in place, you can use it to reach all of Google's services including the full suite of Google Cloud Platform products.

Source: <https://cloud.google.com/interconnect/docs/how-to/direct-peering>

42. In establishing such a direction connection, Google provides the necessary physical

equipment at Megaport to enable such GCI or Direct Peering connections. Google advertises only two GCI facilities in Texas – the Equinix facility and Megaport facility (the latter is located in this District).

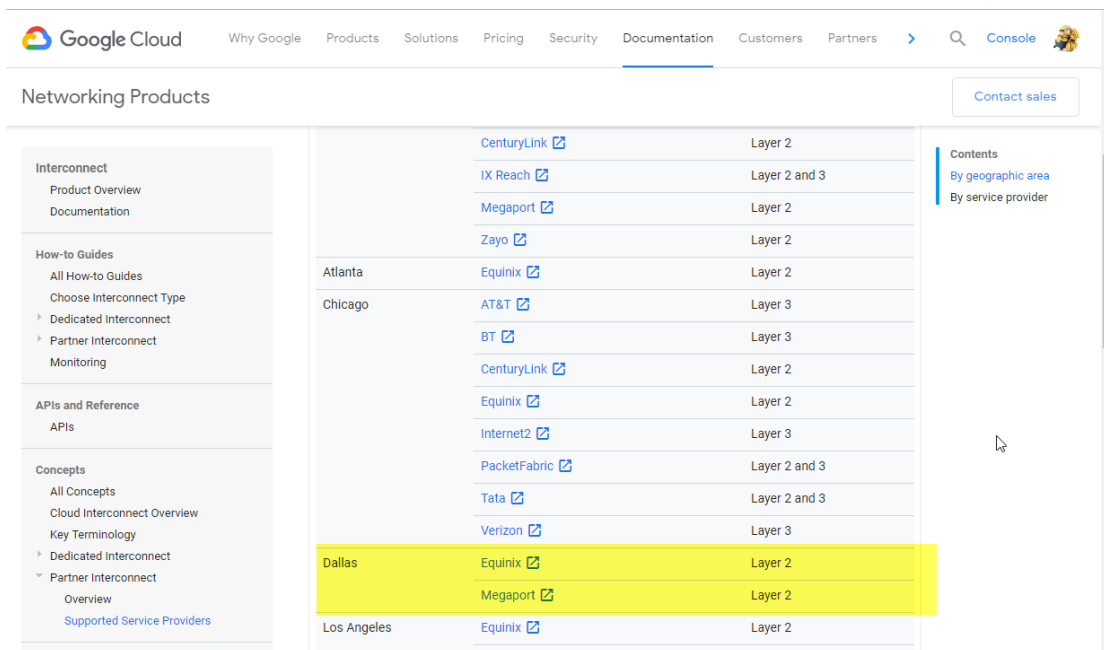

Source: <https://cloud.google.com/interconnect/docs/concepts/service-providers#by-location>

43. Clicking on the Megaport link from screenshot of Google’s website in the preceding paragraph directs a customer as to the details of directly connecting to Google’s equipment at the facility in this District to connect to Google’s GCI service.

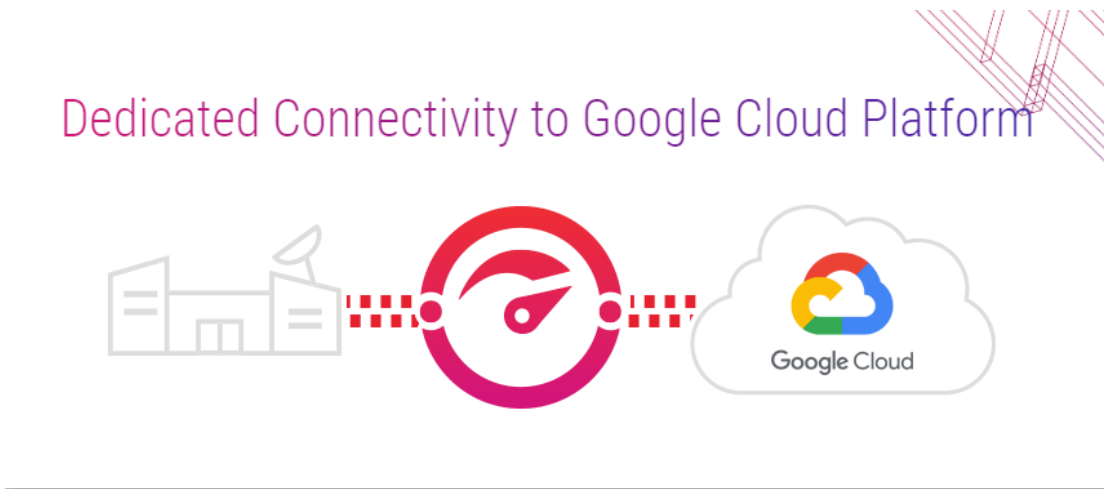

<https://www.megaport.com/services/google-cloud-partner-interconnect/>

44. More particularly, the Google-linked Megaport site explains how a Google customer can use the Google Cloud Platform console to enable connection to the Google equipment at the Megaport facility in this district.

VXC Deployment Steps

First, you will need to log in to your Google Cloud Console and create a Pairing Key: [Google Console Link](#)

Next, click on the main menu in the Google Console, then select 'Hybrid Connectivity' and 'Interconnect' from the drop-down.

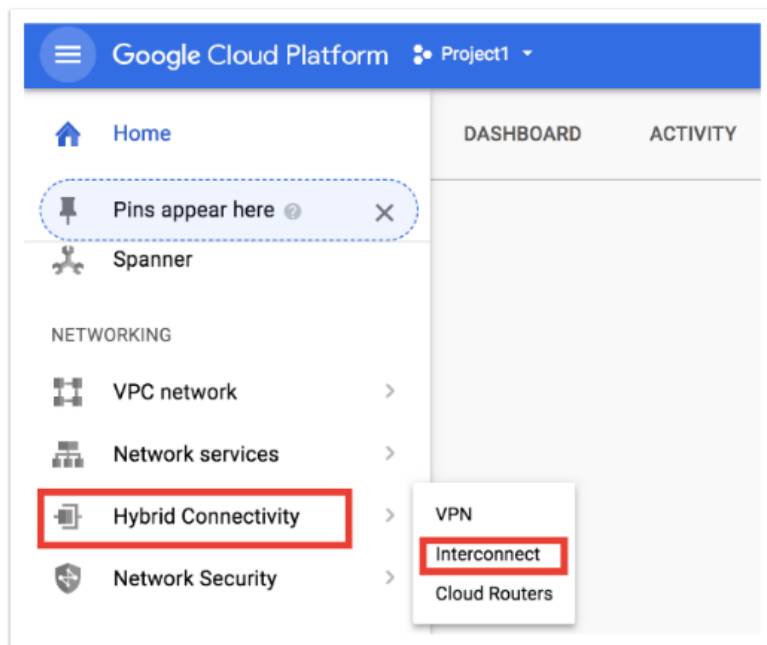

Source: https://knowledgebase.megaport.com/cloud-connectivity/google-cloud/?_ga=2.258056911.476938490.1538320465-1560947970.1538320465

45. Both Google's website and Megaport's website advertise the peering service and point a consumer to the website, www.peeringdb.com, for details. The peering DB website lists Megaport Dallas as a Google peering facility.

Who can peer with Google?

Any Google Cloud Platform customers that meet Google’s technical peering requirements specified in [our peering page](#) can be considered for the direct peering service. Google can peer at the Internet Exchanges (IXPs) and private facilities that are listed in our [PeeringDB entry](#).

Source: <https://cloud.google.com/interconnect/docs/how-to/direct-peering>

Megaport – Google IX Peering Locations:

- MegalX: Ashburn, Dallas, Los Angeles, Seattle, Singapore, Sofia, Sydney
- AMS-IX: Chicago, New York, Bay Area

See [PeeringDB](#) for additional details.

<https://knowledgebase.megaport.com/cloud-connectivity/google-cloud-platform-direct-peering/>

The screenshot shows the PeeringDB website interface. At the top, there is a search bar with the text "Search here for a network, IX, or facility." and buttons for "Register or Login". Below the search bar, the profile for "Google LLC" is displayed, including fields for "Organization", "Also Known As", "Company Website", "Primary ASN", "IRR Record", and "Route Server URL". To the right of the profile, there is a table titled "Public Peering Exchange Points" with columns for "Exchange", "ASN", "IPv4", "IPv6", "Speed", "RS", and "Peer". The "MegalX Dallas" entry is circled in green.

Exchange	ASN	IPv4	IPv6	Speed	RS	Peer
MegalX Dallas	15169	206.53.174.7	2606:a980:0:7::7	10G	✓	✓
MegalX Los Angeles	15169	206.53.172.10	2606:a980:0:5::a	10G	✓	✓

<https://www.peeringdb.com/net/433>

46. Megaport’s website also confirms in its “Looking Glass” tool the presence of Google at its facility – (AS No. 15169).

The screenshot shows the Megaport Portal interface. On the left, a sidebar titled "Looking Glass" lists several IX locations: Ashburn IX (ASN: 64216), Auckland IX (ASN: 63839), Brisbane IX (ASN: 58942), Dallas IX (ASN: 64222), Las Vegas IX (ASN: 64220), Los Angeles IX (ASN: 64220), Melbourne IX (ASN: 58943), and Perth IX (ASN: 58941). The main content area is titled "Dallas IX" and displays a table of ASes. The table has columns for DESCRIPTION, AS, RS1, and RS2. The AS 15169 (Google Inc.) is highlighted in a grey row, with its AS number also highlighted in a red box. Below this, there are tabs for "Primary" and "Secondary", and a "Close" button. The "Primary" tab is active, showing a routing table with columns: PREFIX, BEST, NEXT HOP, LOCAL PREF, ORIGIN, AS PATH, and SINCE. The routing table contains several entries for the prefix 104.132.0.0/14 and its subnets, showing the path through AS 15169.

DESCRIPTION	AS	RS1	RS2	Details	Routes
Akamai International B.V.	20940	●	●	Details	Routes
CloudFlare	13335	●	●	Details	Routes
DSV AS	49362	●	●	Details	Routes
Google Inc	15169	●	●	Details	Routes

PREFIX	BEST	NEXT HOP	LOCAL PREF	ORIGIN	AS PATH	SINCE
104.132.0.0/14	Y	206.53.174.7	100	36384	15169 36384	2018-08-23 22:12
104.132.113.0/24	Y	206.53.174.7	100	41264	15169 41264	2018-09-25 23:23
104.132.114.0/24	Y	206.53.174.7	100	41264	15169 41264	2018-09-07 19:02
104.132.116.0/24	Y	206.53.174.7	100	41264	15169 41264	2018-09-19 14:47
104.132.117.0/24	Y	206.53.174.7	100	41264	15169 36384 41264	2018-09-24 02:19
104.132.118.0/24	Y	206.53.174.7	100	41264	15169 41264	2018-09-21 20:03
104.132.119.0/24	Y	206.53.174.7	100	41264	15169 41264 41264	2018-09-30 10:14

Source: <https://portal.megaport.com/tools/looking-glass>

47. Both of Megaport’s “Dallas” locations are in the Eastern District of Texas in Denton County.¹² The larger Megaport facility, the Carrollton facility, is located at 1649 West Frankford Rd and is the largest of its kind in the state of Texas.¹³ The smaller Megaport facility, the Lewisville facility, is located at 2501 St. State Hwy 121.

48. The Google equipment at Megaport’s facilities which provide the GCI and Direct Peering services for Google customer are fixed geographical locations. They are “regular” and “established” because they operate in a “steady, uniform, orderly, and methodical manner” and are sufficiently permanent. They are “of the defendant” because Google holds contractual and/or property rights to use this space and to maintain this equipment. Google also ratifies the equipment through advertising of the Megaport location as authorized to provide these Google services.

¹² <https://www.megaport.com/blog/cyrusone-brings-dallas-closer-cloud/>

¹³ *Id.*

Other Google Presence in this District

49. In addition to the Google presence described above, Google has other pervasive contacts in this District.

50. Google has multiple authorized repair centers in the Eastern District. A resident can visit Google’s website to find a list of these repair centers:

United States	uBreakiFix	Pixel, Pixel XL, Pixel 2, Pixel 2 XL	Walk-in	<ul style="list-style-type: none"> uBreakiFix Phone: 1-877-320-2237
	Puls	Pixel, Pixel XL, Pixel 2, Pixel 2 XL	At home (Dial-in)	<ul style="list-style-type: none"> Puls Phone: (855) 256-3709
	Google	Pixel, Pixel XL, Pixel 2, Pixel 2 XL	Mail-in	<ul style="list-style-type: none"> Google Repair program currently expanding, option might not be available

In US and Canada, replacement of parts or product service is made available for a minimum of three years after end of production for all phones through Google or its service providers.

Source: <https://support.google.com/store/answer/7182296?hl=en>

51. Google’s only authorized walk-in repair center, uBreakiFix, lists at least four facilities in this District

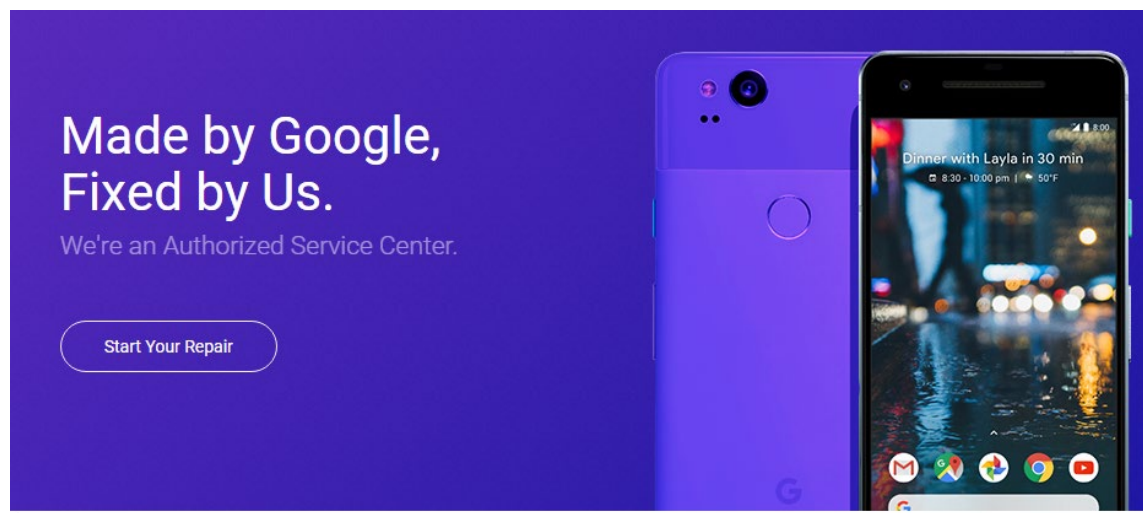

Source: <https://www.ubreakifix.com/google>

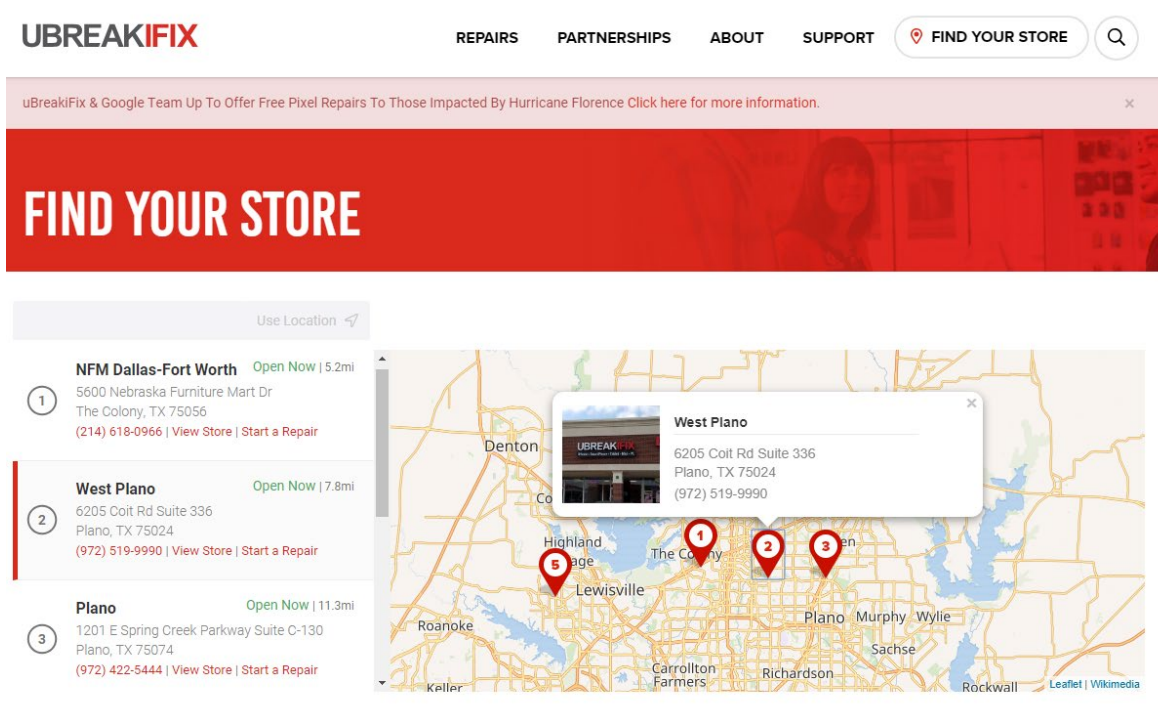

Source: <https://www.ubreakifix.com/google>

52. Google and uBreakiFix teamed up to offer free repairs to those impacted by Hurricane Florence.¹⁴

53. uBreakiFix has fixed geographical location. They are “regular” and “established” because they operate in a “steady, uniform, orderly, and methodical manner” and are sufficiently permanent. These stores are “of the defendant” because Google has contractual rights with uBreakiFix -- the only authorized walk-in repair centers in the United States. Google also ratifies these facilities through its advertising of them through its website.

54. Google’s also has a branded mail-in repair service that is contracted with a company called KMT Wireless, LLC dba Cynergy. Cynergy receives phones at its facility in Grapevine, TX.

¹⁴ See <https://www.ubreakifix.com/blog/hurricane-florence>

United States	uBreakiFix	Pixel, Pixel XL, Pixel 2, Pixel 2 XL	Walk-in	<ul style="list-style-type: none"> • uBreakiFix • Phone: 1-877-320-2237
	Puls	Pixel, Pixel XL, Pixel 2, Pixel 2 XL	At home (Dial-in)	<ul style="list-style-type: none"> • Puls • Phone: (855) 256-3709
	Google	Pixel, Pixel XL, Pixel 2, Pixel 2 XL	Mail-in	<ul style="list-style-type: none"> • Google • Repair program currently expanding, option might not be available

In US and Canada, replacement of parts or product service is made available for a minimum of three years after end of production for all phones through Google or its service providers.

Source: <https://support.google.com/store/answer/7182296?hl=en>

55. Google has operated and is currently operating its Google Maps Street View business and services in this District. For example, the image below shows the Google Maps Street View of the Eastern District of Texas courthouse in Marshall.



Source: <https://www.google.com/maps/@32.5447534,-94.3670371,3a,75y,170.99h,76.06t/data=!3m6!1e1!3m4!1smECZXIUFylR2yu5E-6wj2g!2e0!7i13312!8i6656>

Furthermore, in the lower right-hand corner of the Google Street View above, the image is credited to Google and states that it was captured in June 2016.

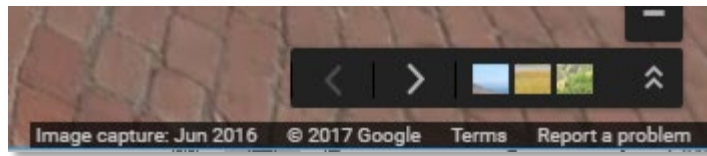

56. Google also operates a Street View car in and around this District in order to provide the Google Maps Street View service.¹⁵

57. In addition to the above Google Street View image, Google operates and continues to operate a fleet of Google Street View vehicles in this District, including in the counties of Houston, Trinity, Polk, Angelina, Anderson, VanZandt, Denton, and Collin, as shown below.

WHERE WE'VE BEEN & WHERE WE'RE HEADED NEXT

The blue areas on the map show where Google has collected Street View. Zoom in for greater detail, or browse this content with our websites and apps. The list shows where we're driving (or Trekking) next. Select a country to browse.

Because of factors outside our control (weather, road closures, etc), it is always possible that our cars may not be operating, or that slight changes may occur. Please also be aware that where the list specifies a particular city, this may include smaller cities and towns that are within driving distance.

United States ▼

Oregon	Clackamas County, Multnomah County, Washington County	June 2018 – October 2018
Pennsylvania	Delaware, Philadelphia, Bucks, Montgomery, Berks, Lancaster, York, Lebanon, Dauphin, Schuylkill, Lehigh, Northampton, Adams, Venango, Clarion, Jefferson, Indiana, Armstrong, Butler, Allegheny, Westmoreland	March 2018 – November 2018
Tennessee	Knox, Jefferson, Grainger, Union, Anderson, Rane, Loudon	March 2018 – October 2018
Texas	Houston, Trinity, Polk, Angelina, Anderson, Leon, Madison, Walker, Caldwell, Comal, Guadalupe, Hays, Travis, Williamson, Dallas, Ellis, Johnson, Hood, Tarrant, Rockwall, Rains, VanZandt, Denton, Collin, Hunt	January 2018 – December 2018
Virginia	New Kent, Sussex, Hanover, Caroline, Essex, King and Queen, Gloucester, York, King William	June 2018 –

Source: <https://www.google.com/streetview/understand/>

¹⁵ See <https://www.google.com/streetview/understand/>

58. Google also has operated and currently operates its Google Express business and services in this District. Google Express allows residents of this District to shop – directly from Google’s website – for select products with companies that Google has contracted with.

About Google Express

Get your shopping done fast

**Many top stores,
one fast checkout.**

Shop [Walmart](#), [Costco](#), [Target](#), and more—all in one place. Enter your info once, whether you’re checking out from one store or five. Need it again? A few quick taps is all it takes to reorder things you buy regularly.

**A shopping list
you’ll never forget.**

Start a shopping list on Google Express and add to it or check things off from the website or app, wherever you are. Add items for later, share it with others, and shop from it with just a click. Check out these [step-by-step instructions](#).

**Free delivery,
no membership.**

Order the store minimum for free delivery—\$25 to \$35 in most cases. No memberships here.

**Shop by voice,
and app, and web.**

When you think of something you need, you can shop for it on the app, the website, or with your Google Home device just by saying “OK Google, buy olive oil,” and [get help here](#).

How it works

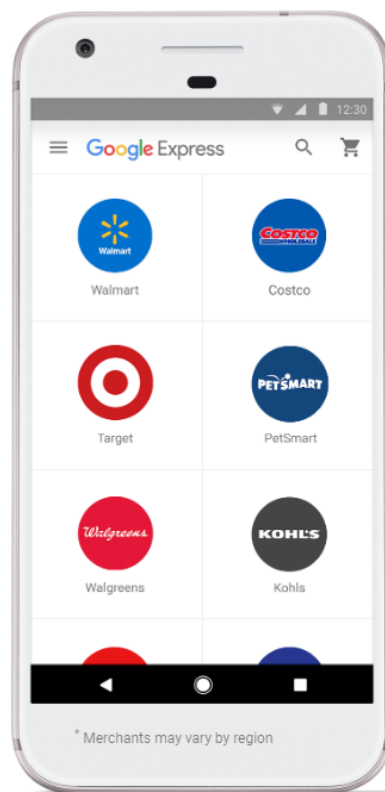
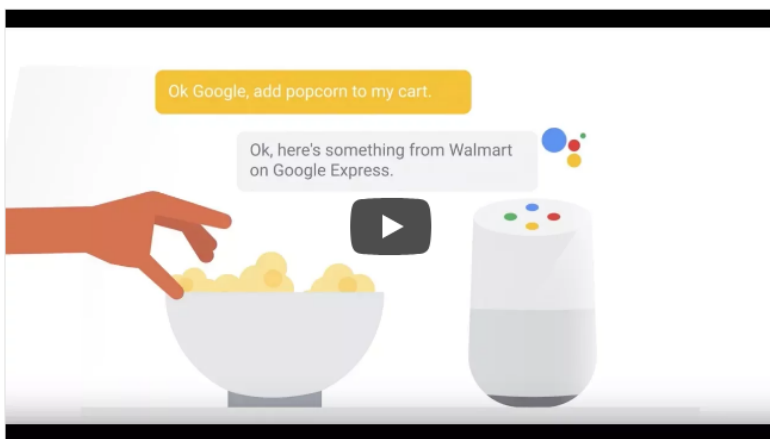

Source: <https://express.google.com/u/0/about>

To verify which stores a user may shop, a resident enters his or her zip code and begins shopping at the Google contracted stores. The image below shows the Google Express website showing

that its business and services are available in this District.

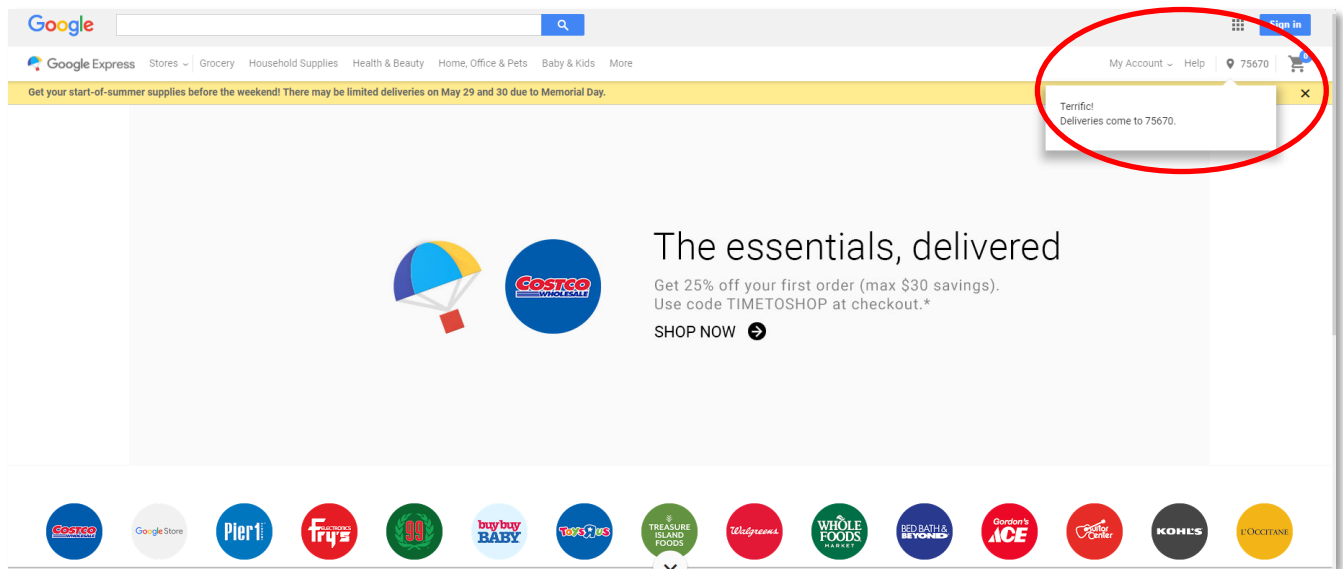

Source: <https://www.google.com/express/>

59. Google provides its Google Express business and services to the residents of this District by advertising and inviting the residents of this District, then Defendant arranges for a delivery company to bring the goods and products purchased through the Google Express website to the residents of this District.¹⁶ This service uses fixed geographical stores in this District. They are “regular” and “established” because they operate in a “steady, uniform, orderly, and methodical manner” and are sufficiently permanent. They are “of the defendant” because Google ratifies the stores (and select products of the stores) through its website. Only information provided by Google through its service can be purchased although the store may have other items for sale.

60. Google previously leased office space in this District for about 50 people through its Frisco, TX office.

61. Google also provides services to business and schools in this District including email services, word processing software, electronic file storage services, and video conferencing

¹⁶ See <https://support.google.com/express/answer/4561693?hl=en>

services. Google brands such services as “G Suite” services. Non-limiting examples of such business and schools include the Frisco Independent School District, as shown below.¹⁷

How do I login?

Each student in Fisd has a Google login. The username is their Frisco ISD email address, which is firstname.lastname.###@k12.friscoisd.org

where the ### is the last three digits of their student id#. This address uses the full legal first name and full legal last name of the student, and does not recognize nicknames. All teachers have access to student gmail addresses and can help if you aren't sure what the username is.

The password will most likely be the student birth date in 8 digits MMDDYYYY.

Source: <http://schools.friscoisd.org/ms/vandeventer/site/resources/accessing-google-applications>

62. Google also provides advertising services to businesses in this District, including soliciting reviews of patrons that have visited a business in the Eastern District of Texas, as shown below.

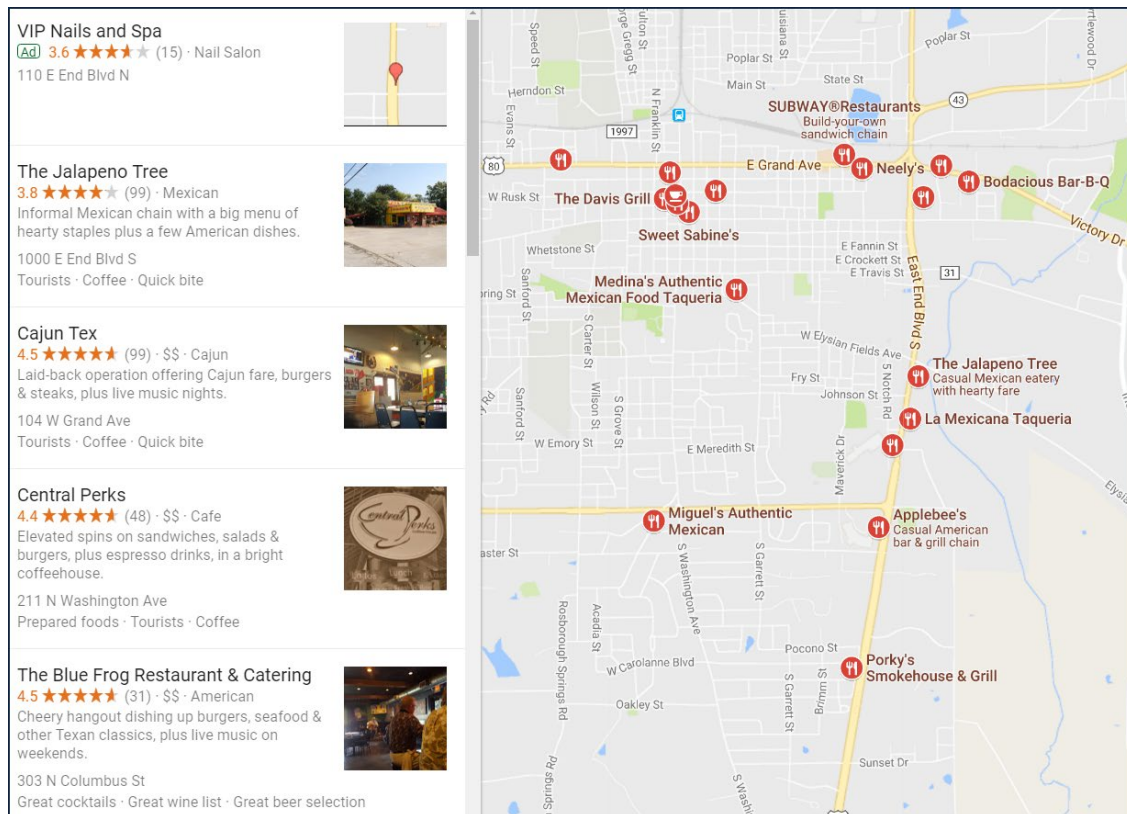

¹⁷ See <http://schools.friscoisd.org/ms/vandeventer/site/resources/accessing-google-applications>

Source: product testing through www.maps.google.com

63. Google also monitors traffic conditions in this District. For example, traffic conditions between a McDonalds and the Federal Courthouse in Marshall, as shown below.

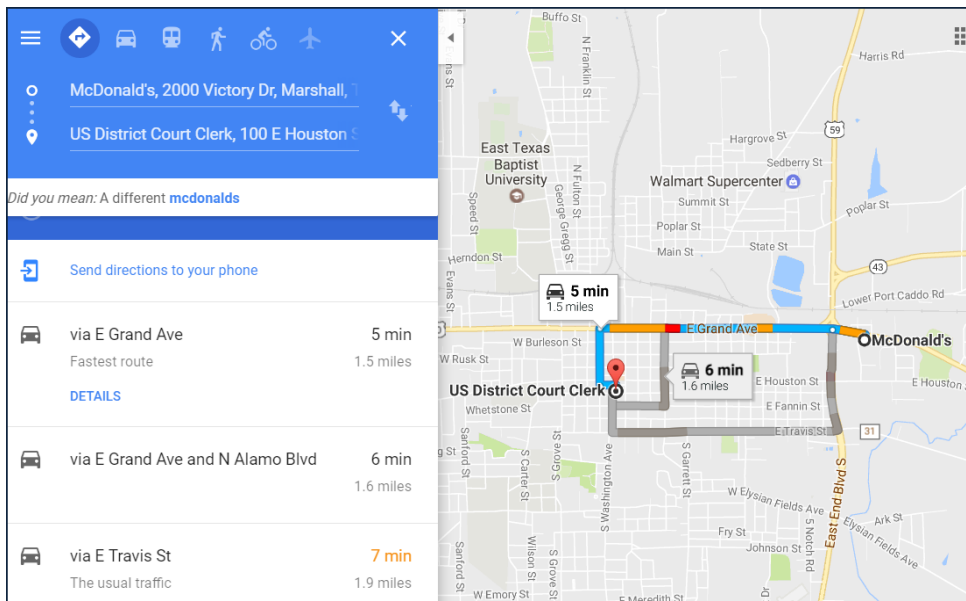

Source: Product testing at www.maps.google.com

64. Separate and apart from its Google Fi mobile service, Google also provides telephone services to residents in this District through a product it calls Google Voice.¹⁸ A user of Google voice can select local numbers, for example, in Marshall, TX.

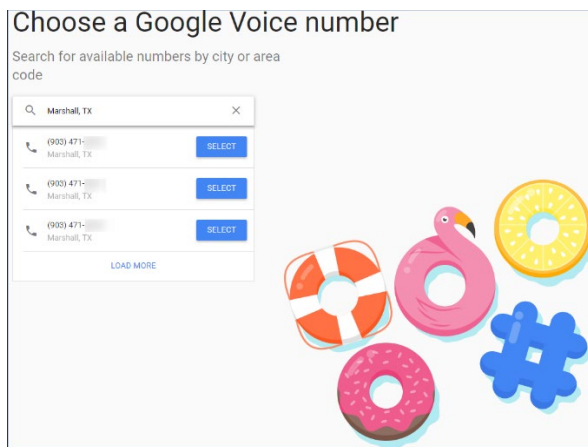

¹⁸ See <http://www.wikihow.com/Get-a-Google-Voice-Phone-Number>

Source: Product testing at <https://voice.google.com/signup>

65. Google provides Software-as-a-Service applications, including email and server space, to Texas public universities. Non-limiting examples of such universities are Texas A&M University (which has facilities in this District) and Texas A&M Commerce (located in this District), as shown below.

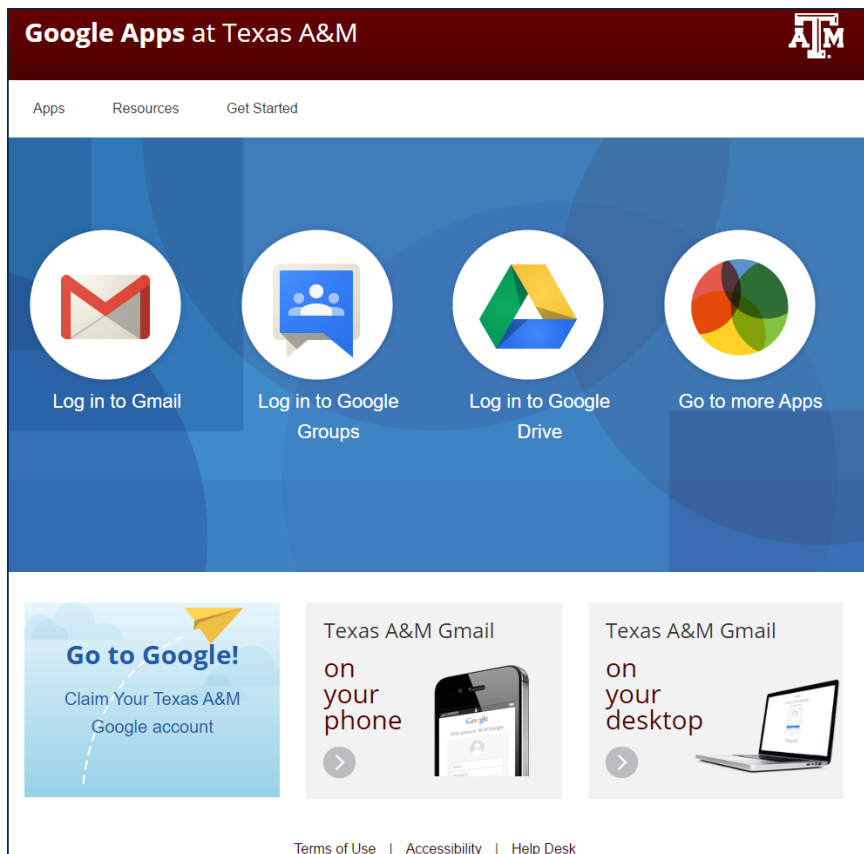

Source: <http://google.tamu.edu/>

Welcome Lions to your new LeoMail 2.0 found in your myLEO homepage located at myLEO.tamu-commerce.edu. We hope you take some time to look through your new student email. As a reminder the new email is a gmail platform and share many features that a regular gmail account has.

In addition to email, you will have the ability to build your own contacts list and use the built in calendar for planning and organizing. The most asked question has revolved around the ability to sync this email account with your mobile or smart phone device. The answer is ³yes². The Portal Implementation Team is working on getting both the email and your NEW myLEO account connected in an application that will be available in June.

Source: <http://mailman.tamuc.edu/pipermail/students/2012-May/004325.html>

Other Google Presence in the State

1. Google also has pervasive connection to the state of Texas through multiple commercial activities.
2. Google has purchased land in Midlothian, TX where it plans to build a half-a-billion dollar data center.¹⁹
3. Since 2007, Google has employed “hundreds” of employees in Texas, including in Austin, Texas.²⁰
4. Google has at least one current office located in Austin, on North MoPac Expressway,²¹ and additional office locations at University Park and Austin’s Children Museum.²²
5. Google has leased over 200,000 square feet of office space in Austin, Texas, at 500 West 2nd Street.²³
6. Google has, as of September 2018, job postings for Addison, TX; Dallas, TX; Midlothian, TX; and Austin, TX (38 postings) including positions such as:²⁴

¹⁹ See <https://www.datacenterknowledge.com/google-alphabet/google-buys-property-build-data-center-near-dallas>

²⁰ According to Gerardo Interiano, Google's public affairs and government relations manager, in a statement. See <http://www.statesman.com/business/google-lease-200-000-square-feet-new-downtown-austin-tower/SANZSa3du8QQ4k8ytOC2rJ/>

²¹ See <https://www.google.com/intl/en/about/locations/?region=north-america>

²² See <http://www.statesman.com/business/google-lease-200-000-square-feet-new-downtown-austin-tower/SANZSa3du8QQ4k8ytOC2rJ/>

²³ See <http://www.statesman.com/business/google-lease-200-000-square-feet-new-downtown-austin-tower/SANZSa3du8QQ4k8ytOC2rJ/>

²⁴ See <https://careers.google.com/jobs#t=sq&q=j&li=20&l=false&jl=32.7766642%3A-96.79698789999998%3ADallas%2C+TX%2C+USA%3AUS%3A%3A25.77719109274963%3ALOCALITY&jld=20&&jcoid=7c8c6665-81cf-4e11-8fc9-ec1d6a69120c&jcoid=e43afd0d-d215-45db-a154-5386c9036525&> and <https://careers.google.com/jobs#t=sq&q=j&li=20&l=false&jlo=en-US&jcoid=7c8c6665-81cf-4e11-8fc9-ec1d6a69120c&jcoid=e43afd0d-d215-45db-a154-5386c9036525&jl=30.267153%3A-97.74306079999997%3AAustin%2C+TX%2C+USA%3AUS%3A%3A20.13709231046343%3ALOCALITY%3A%3A%3A%3A%3A%3A%3A%3A%3A%3A%3A%3A&jld=20&>

- Network Transport Engineer (Midlothian)
- Project Controls Group Lead, Google Data Centers (Dallas)
- Network Engineer, Tools (Addison)
- Cluster Security Manager (Austin)

7. Upon information and belief, Defendant has at least eleven (11) entities registered in Texas, including:

- GOOGLE LLC
- GOOGLE ACQUISITION HOLDING, INC.
- GOOGLE COMPARE AUTO INSURANCE SERVICES INC.
- GOOGLE COMPARE CREDIT CARDS INC.
- GOOGLE COMPARE MORTGAGES INC.
- GOOGLE FIBER INC.
- GOOGLE FIBER NORTH AMERICA INC.
- GOOGLE FIBER TEXAS, LLC
- GOOGLE INC.
- GOOGLE NORTH AMERICA INC.
- GOOGLE PAYMENT CORP.

8. Google has provided, currently provides, and is currently offering to provide its Google Fiber services to the residents of Austin, Texas and San Antonio, Texas.²⁵

9. Google has invested \$200,000,000 in the Spinning Spur wind farm project in Oldham County, Texas.²⁶

²⁵ See <https://fiber.google.com/cities/austin/> and <https://fiber.google.com/cities/sanantonio/>

²⁶ See <https://www.chooseenergy.com/blog/energy-news/google-invests-200m-in-west-texas-wind-farm/>

10. Google has massively scanned books from Texas public universities.



Source: <https://www.lib.utexas.edu/google/faqs.html>

11. Google provides the State of Texas with aerial imagery.²⁷

12. Google acquired Waze in 2013,²⁸ and Google's Waze traffic app partners with cities and business in Texas, non-limiting examples include the Waze partnership with the city of Fort Worth to provide constant traffic data to the city.²⁹ Another non-limiting example includes the Waze partnership with the Genesis Group in Tyler, to decrease emergency response times.³⁰

COUNT I

(INFRINGEMENT OF U.S. PATENT NO. 7,012,960)

13. Uniloc incorporates the preceding paragraphs above by reference.

14. U.S. Patent No. 7,012,960 ("the '960 Patent"), entitled METHOD OF TRANSCODING AND TRANSCODING DEVICE WITH EMBEDDED FILTERS issued on March 14, 2006. The '960 lists Arnaud Bourge and Anthony Morel as inventors. A true and correct copy of the '960 Patent is attached as Exhibit A hereto.

15. Pursuant to 35 U.S.C. § 282, the '960 Patent is presumed valid. The '960 Patent describes inventive features that are not well-understood, routine, and conventional.

²⁷ See <http://www.bisconsultants.com/affordable-imagery-for-texas-government-entities-from-google/>

²⁸ See <https://techcrunch.com/2013/06/11/its-official-google-buys-waze-giving-a-social-data-boost-to-its-location-and-mapping-business/>

²⁹ See <http://dfw.cbslocal.com/2016/12/14/forth-worth-partners-with-waze-traffic-app/>

³⁰ See <https://genesispulse.com/2015/10/06/the-genesis-group-joins-waze-connected-citizens-program/>





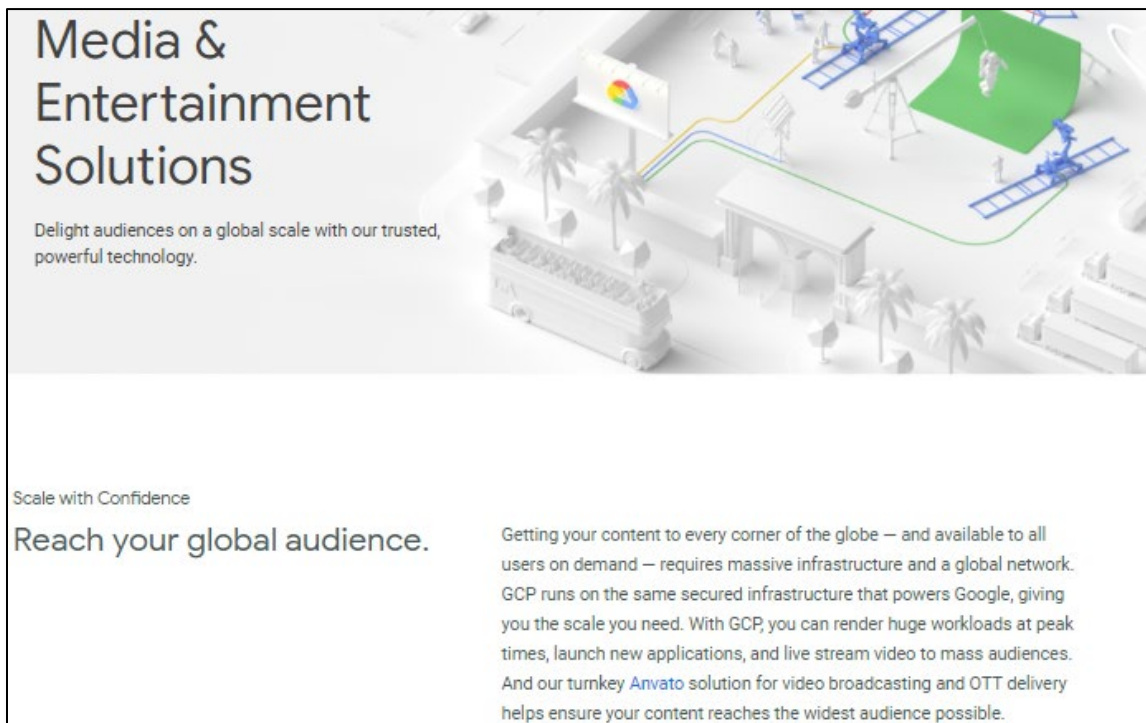

16. Google makes, uses, offers for sale, sells and/or imports into the United States a product referred to as the Google Cloud platform. The Google Cloud platform provides media and entertainment solutions to operators for content delivery and video broadcasting. The Google Cloud platform provides various components of the video ecosystem that perform various tasks from ingest to transcoding, protecting and managing content to monetization, delivery and analytics. Collectively, such a system is referred to as the “Accused Infringing Devices.”

17. As part of its Google Cloud platform Google markets the Accused Infringing Devices as its “Media & Entertainment Solutions.”

The image is a screenshot of a webpage for Google Cloud's Media & Entertainment Solutions. The top left features the title "Media & Entertainment Solutions" in a large, bold, sans-serif font. Below the title is a sub-headline: "Delight audiences on a global scale with our trusted, powerful technology." The background of the top half is a 3D isometric illustration of a city with various buildings, palm trees, and a large green screen or stage area. A colorful line (red, yellow, green) winds through the scene, representing a data or content flow. The bottom half of the image is a white text box. On the left, it says "Scale with Confidence" in a small font, followed by "Reach your global audience." in a larger, bold font. On the right, there is a paragraph of text: "Getting your content to every corner of the globe — and available to all users on demand — requires massive infrastructure and a global network. GCP runs on the same secured infrastructure that powers Google, giving you the scale you need. With GCP, you can render huge workloads at peak times, launch new applications, and live stream video to mass audiences. And our turnkey [Anvato](#) solution for video broadcasting and OTT delivery helps ensure your content reaches the widest audience possible."

Source: <https://cloud.google.com/solutions/media-entertainment/>

18. Google’s Media & Entertainment solutions provides video encoding and transcoding process to provide seamless delivery to multiple formats such as H.264, HEVC and others via adaptive bitrate streaming on different platforms like smartphones, tablets, TV etc.

 <h3>Rendering</h3> <p>Harness the computational power and global reach of Google's infrastructure, directly from the 3D modeling tools artists already use. Unlock unprecedented scale and cost savings when your project needs it most.</p> <p>LEARN MORE</p>	 <h3>Live Streaming</h3> <p>Scale and simplify your live streaming infrastructure. We provide you with everything you need for flawless, stunning live linear stream origination.</p> <p>LEARN MORE</p>	 <h3>Live-to-VOD</h3> <p>Create video-on-demand files from live streams and syndicate to premium and social destinations in near real time.</p> <p>LEARN MORE</p>
 <h3>Video Encoding/Transcoding</h3> <p>Unique hybrid cloud encoding technology combines the power and scale of Google's cloud technologies with the advantages on-premises processing provides.</p>	 <h3>Cloud Editing</h3> <p>Cut clips on your computer or mobile device as they happen. Syndicate those clips to all screens and social media in minutes.</p>	 <h3>Social & Premium Syndication</h3> <p>Distribute your content to premium destinations such as Comcast, Netflix, Hulu, etc, as well as social destinations like YouTube, Facebook and Twitter.</p>

Source: <https://cloud.google.com/solutions/media-entertainment/use-cases/>

Video Encoding and Transcoding

Unique hybrid cloud encoding technology combines the power and scale of Google's cloud technologies with the advantages on-premises processing provides

[CONTACT SALES](#)

Leverage the best benefits of on and off-premise resources

Harnessing both on-premises hardware and the elastic scale of Google technologies such as [Compute Engine](#) and our own [Cloud Delivery Network \(CDN\)](#), our encoding and transcoding technology provides you with one of the most powerful and cost-effective offerings in the industry. Whether you are looking to process one live linear streaming event, or ingesting and processing thousands of on-demand assets, intuitive algorithms determine where and how to process your content so you can reach maximum efficiency without compromising quality or time to market service level agreements.

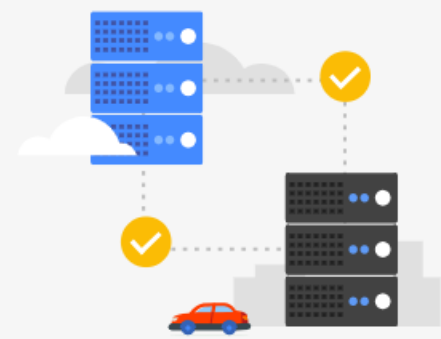

Source: <https://cloud.google.com/solutions/media-entertainment/use-cases/video-encoding-transcoding/>

Optimized Streaming Using Adaptive Bitrate (ABR) Technology

Regardless of bandwidth constraints, end-users can experience a seamless playback experience regardless of device. Multi-bitrate video streams are delivered to end-users on all platforms including smartphones, tablets, connected TVs, gaming consoles and more.



Source: <https://cloud.google.com/solutions/media-entertainment/use-cases/live-streaming/>

19. The Google Cloud platform provides the encoding and transcoding service to distribute the content. The below illustration shows the architecture of encoding and transcoding service for seamless delivery to multiple formats. In case of live streaming, the encoding block encodes the signal (i.e., the sequence of pictures) coming from the live events to get the primary encoded signal which is further transcoded (i.e., converted to secondary encoded signal) to deliver the content to different platforms. In case of video-on-demand (VOD), the encoded signal is already stored as the source file in a particular format which is further encoded to deliver it to multiple platforms via adaptive bitrate streaming.

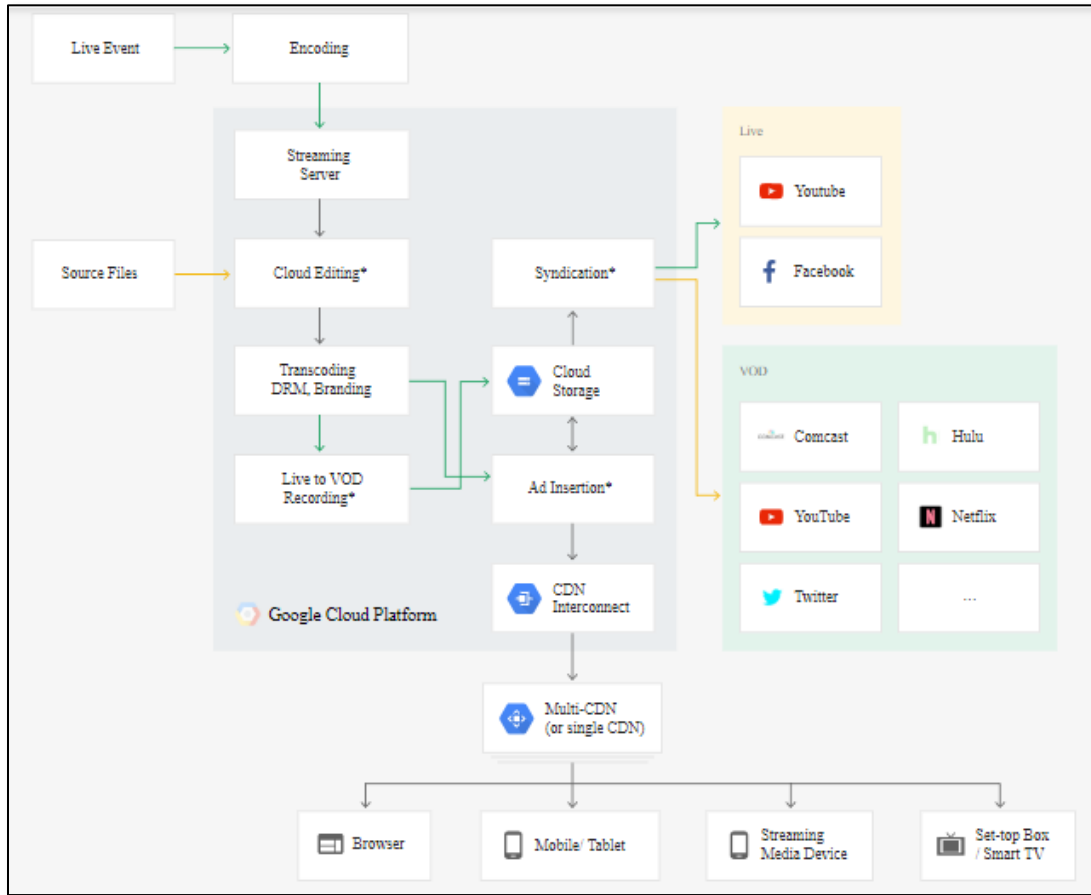

Source: <https://cloud.google.com/solutions/media-entertainment/architecture/transcoding/>

20. The real-time encoding and point-to-point delivery can be achieved by maintaining source encoding and decoding including quantization parameter or a frame rate, based on the network. In typical streaming scenarios transcoded video bitstream is to be sent to a client. The Adaptive-bit-rate (ABR) method is used for streaming video contents.

21. The Google Cloud platform encodes to multiple formats.

Encode to Multiple Formats

Seamless delivery to multiple formats such as H.264, HEVC and others via progressive download or adaptive bitrate streaming ensures your content reaches your audience regardless of bandwidth constraints or device. Digital Rights Management (DRM) from providers Widevine, PlayReady and FairPlay is included.

Source: <https://cloud.google.com/solutions/media-entertainment/use-cases/video-encoding-transcoding/>

22. The switching among multiple bitstreams at different bit rates is accomplished by inserting some special frames in the bitstreams, known as key frames. SP/SI frames (as described in H.264) are one of the key frames that exploit temporal redundancy by motion-compensated predictive coding.

23. The process of transcoding using SP frames includes the decoding process which involves the inverse quantization (i.e., Qs_{1-1}) of the current picture sequence/video to produce the first transformed signal.

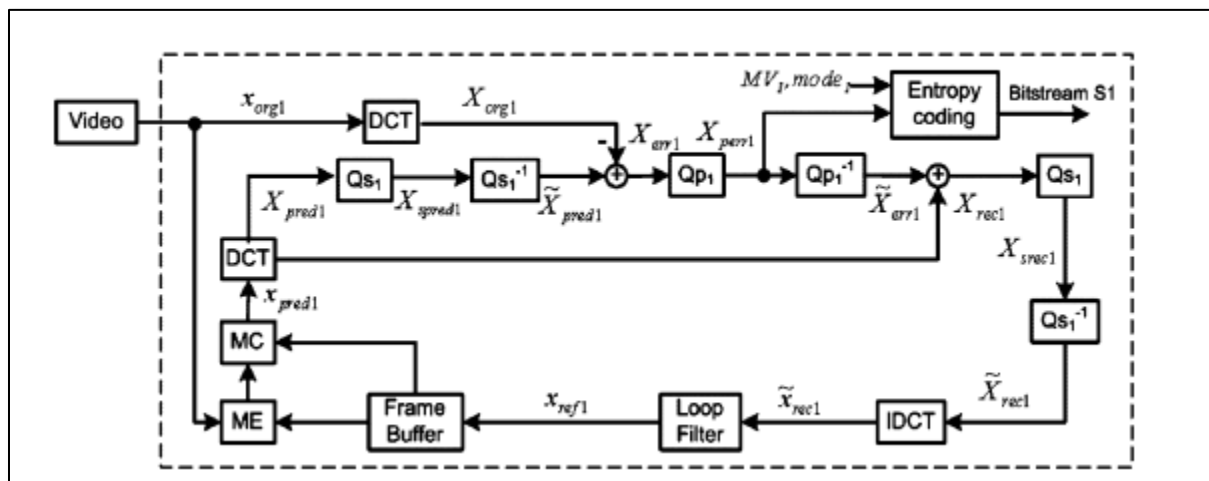

Source: https://www.researchgate.net/publication/3308924_Drift-free_switching_of_compressed_video_bitstreams_at_predictive_frames

24. In the Google Cloud platform processing, a pre-encoded signal is decoded that includes dequantization. To transcode the signal, the decoded signal is further quantized. A “loop filter” operates as the deblocking filter between the dequantization and quantization to provide the reconstructed reference X_{ref1} , which is used to update the frame buffer.

25. The original frame as well as the temporal prediction undergo Discrete Cosine Transformation (DCT) to generate X_{pred1} and X_{org1} . The difference between X_{pred1} and X_{org1} , which

is X_{err1} , is quantized with quantization parameter Q_{p1} , to obtain the error i.e., X_{perr1} . X_{perr1} is de-quantized, and the resulting de-quantized error is added to X_{pred1} to generate the DCT reconstruction X_{rec1} . This prediction step is situated between dequantization and quantization step Q_{s1}^{-1} and Q_{p1} .

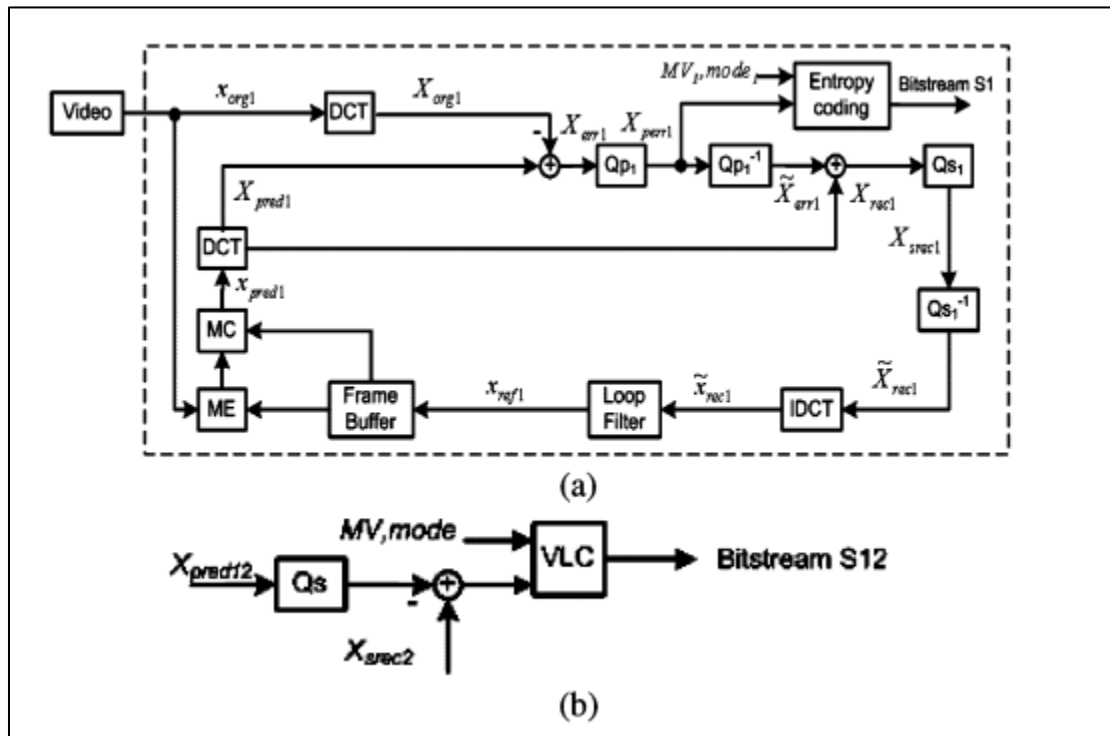

Source: https://www.researchgate.net/publication/3308924_Drift-free_switching_of_compressed_video_bitstreams_at_predictive_frames

26. X_{rec1} is quantized and de-quantized with Q_{s1} to get the final reconstructed signal. The final reconstructed signal \tilde{X}_{rec1} is inverse DCT-transformed followed by a loop filter to provide the reconstructed reference, which is used to update the frame buffer i.e., \tilde{X}_{rec1} goes through the optional inverse DCT transform and de-blocking filter to form an image for display.

27. The loop filter provides the reconstructed reference, X_{ref1} that is further used to calculate the motion compensated signal which is further transformed using DCT to predict the transformed motion compensated signal.

28. The loop filter provides the reconstructed reference, X_{ref1} that is further used to calculate the motion compensated signal which is further transformed using DCT to predict the

transformed motion compensated signal.

29. Google has directly infringed and continues to directly infringe one or more claims of the '960 Patent in the United States during the pendency of the '960 Patent, including at least claim 4 literally and/or under the doctrine of equivalents, by or through making, using, offering for sale and/or selling the Accused Infringing Devices that operate as described above.

30. In addition, should the Accused Infringing Devices be found to not literally infringe claims of the '960 Patent, use of the devices would nevertheless infringe one or more claims of the '960 Patent. More specifically, the devices perform substantially the same function (providing a transcoded video) in substantially the same way (via filtering between dequantization and quantization) to yield substantially the same result (a transcoded video). Google would thus be liable for direct infringement under the doctrine of equivalents.

31. Google has indirectly infringed and continues to indirectly infringe at least claim 4 of the '960 Patent in this judicial district and elsewhere in the United States by, among other things, actively inducing the using, offering for sale or selling the Accused Infringing Devices. Google's customers who use such devices in accordance with Google's instructions directly infringe one or more of claims of the '960 Patent in violation of 35 U.S.C. § 271. Google directly and/or indirectly intentionally instructs its customers to infringe through training videos, demonstrations, brochures, installation and/or user guides such as those located at one or more of the following:

- <https://cloud.google.com/solutions/media-entertainment/>
- <https://cloud.google.com/solutions/media-entertainment/use-cases/>
- <https://cloud.google.com/solutions/media-entertainment/use-cases/video-encoding-transcoding/>
- <https://cloud.google.com/solutions/media-entertainment/use-cases/live-streaming/>
- <https://cloud.google.com/solutions/media-entertainment/architecture/transcoding/>

32. Google has indirectly infringed and continues to indirectly infringe at least claim 4

of the '960 Patent by, among other things, contributing to the direct infringement by others including, without limitation customers using the Accused Infringing Devices, by making, offering to sell, selling and/or importing into the United States, a component of a patented machine, manufacture or combination, or an apparatus for use in practicing a patented process, constituting a material part of the invention, knowing the same to be especially made or especially adapted for use in infringing the '960 Patent and not a staple article or commodity of commerce suitable for substantial non-infringing use.

33. Google will have been on notice of the '960 Patent since, at the latest, the service of this complaint upon Google. By the time of trial, Google will have known and intended (since receiving such notice) that its continued actions would actively induce and contribute to the infringement of one or more of claims of the '960 Patent.

34. Google may have infringed the '960 Patent through other devices, systems, and software utilizing the same or reasonably similar functionality as described above. Uniloc reserves the right to discover and pursue all such additional infringing software and devices.

35. Uniloc has been damaged by Google's infringement of the '960 Patent.

PRAYER FOR RELIEF

Uniloc requests that the Court enter judgment against Google as follows:

- (A) declaring that Google has infringed the '960 Patent;
- (B) awarding Uniloc its damages suffered as a result of Google's infringement of the '960 Patent pursuant to 35 U.S.C. § 284;
- (C) awarding Uniloc its costs, attorneys' fees, expenses and interest; and
- (D) granting Uniloc such further relief as the Court may deem just and proper.

DEMAND FOR JURY TRIAL

Uniloc hereby demands trial by jury on all issues so triable pursuant to Fed. R. Civ. P. 38.

Dated: December 31, 2018

Respectfully submitted,

By: /s/ James L. Etheridge

James L. Etheridge

Texas Bar No. 24059147

Ryan S. Loveless

Texas Bar No. 24036997

Brett A. Mangrum

Texas Bar No. 24065671

Travis L. Richins

Texas Bar No. 24061296

Jeff Huang

Etheridge Law Group, PLLC

2600 E. Southlake Blvd., Suite 120 / 324

Southlake, TX 76092

Tel.: (817) 470-7249

Fax: (817) 887-5950

Jim@EtheridgeLaw.com

Ryan@EtheridgeLaw.com

Brett@EtheridgeLaw.com

Travis@EtheridgeLaw.com

Jeff@EtheridgeLaw.com

ATTORNEYS FOR UNILOC 2017

v