

**IN THE UNITED STATES DISTRICT COURT
FOR THE EASTERN DISTRICT OF TEXAS
MARSHALL DIVISION**

K.MIZRA LLC,

Plaintiff,

v.

HP INC.,

Defendant.

Civil Action No.:

Jury Trial Demanded

COMPLAINT FOR PATENT INFRINGEMENT

Plaintiff K.Mizra LLC ("Plaintiff" or "K.Mizra"), for its Complaint with Jury Demand for Patent Infringement against HP Inc. ("Defendant" or "HP"), alleging, based on its own knowledge as to itself and its own actions and based on information and belief as to all other matters, states as follows:

I. INTRODUCTION

A. Sharp and Its Innovations

1. Sharp Corporation ("Sharp") is a Japanese multinational company that has for more than a century conceived, designed, manufactured and sold, first in Japan and then worldwide, various innovative products. Indeed, the company was founded in 1912 in Tokyo and takes its name from one of its founder's first inventions, the Ever-Sharp mechanical pencil. Sharp currently employs more than 50,000 people worldwide and has been inventing the future in numerous existing and emerging product categories for decades.

2. For more than sixty years now, Sharp has been heavily involved in the electronics products business, developing the first Japanese-produced televisions in 1953 and its Mobile Communications Division created the world's first camera phone in 2000. Sharp also was then

investing heavily in its document product and solutions division, earning high praise and prestigious awards from various industry publications and insiders for innovations in printer, copier, and facsimile technologies it was developing and introducing to the market. Indeed, many of these innovations changed these product categories forever and helped to establish multifunction printers, i.e., all-in-one copier, printing, faxing and scanning devices ("MFPs"), as a mainstay of the modern office. These products take many forms, with one such Sharp device being shown below:



3. Sharp's MFPs were precision engineered to make device setup easier and faster than previously available and to provide easy-to-use, efficient and effective multi-level document production and assembly functionality to the modern and typical office worker. Sharp's integrated

product design and engineering approach to developing these state-of-the-art MFP's resulted in providing those office workers increased workflow efficiency, exceptional image quality and an industry standard ease of product operation, control, management, and maintenance, helping to take its customer's business to the next level of productivity and performance.

4. Given its culture of innovation and recognizing that its industry changing concepts often were emulated by "Johnny-come-lately" competitors, Sharp took pains to document and protect its various MFP-focused inventions. These took the form of, among other things, filing and prosecuting to issuance many patents covering various aspects of the technologies it had developed and incorporated over time into its various MFP products. These patents were issued in many countries, including the United States, Germany and Japan. As is too often the case, though, these protections were not self-policing in the MFP industry, with many of Sharp's competitors having taken its patented technologies for themselves and incorporating them into their commercial MFP offerings, but without providing Sharp the economic credit deserved for its many, many efforts and advancements. This case concerns just such a situation.

B. K.Mizra and This Action

5. K.Mizra is a patent licensing company run by experienced management. The company focuses on high value, high quality patents with a global reach and owns patent portfolios originating with a wide array of inventors, including portfolios developed by well-known multinationals such as IBM, Panasonic and ZTE and from research institutes such as National Chiao Tung University and Nederlandse Organisatie voor Toegepast Natuurwetenschappelijk Onderzoek (Netherlands Organization for Applied Scientific Research). By focusing on high quality patents, K.Mizra provides a secondary market for inventors to recoup their research and development investments and to continue their innovations. K.Mizra offers licenses to its patents

on reasonable terms and in this way plays a part in the development of the technologies that make all our lives better.

6. Sharp recently transferred its MFP-focused patents to K.Mizra, which now brings this action to enforce these valid and subsisting United States patent rights. K.Mizra is the owner by assignment of all rights, title, and interests in and to the patents discussed below ("the Asserted Patents").

II. PARTIES

7. Plaintiff is a limited liability company organized and existing under the laws of the State of Delaware and maintains a business address at 777 Brickell Avenue, #500-96031, Miami, Florida 33131.

8. Defendant is a corporation organized under the laws of Delaware. Defendant may be served through its registered agent, CT Corporation System, at 1999 Bryan St., Suite 900, Dallas, TX 75201-3136.

III. JURISDICTION AND VENUE

9. This is an action for patent infringement under the patent laws of the United States, namely, 35 U.S.C. §§ 101 *et seq.*, 271, 281, and 284, among others. This Court has original subject matter jurisdiction over this dispute pursuant to 28 U.S.C. §§ 1331 and 1338(a).

10. This Court has personal jurisdiction over HP pursuant to Due Process Clause and/or the Texas Long Arm Statute because, *inter alia*, (i) HP has done and continues to do business in Texas; (ii) HP has committed and continues to commit acts of patent infringement in the State of Texas, including making, using, offering to sell, and/or selling the products identified below and colorable imitations thereof ("Accused Products") in Texas, and/or importing accused products into Texas, including by Internet sales and sales via retail and wholesale stores, inducing others to

commit acts of patent infringement in Texas, and/or committing a least a portion of any other infringements alleged herein; and (iii) HP is registered to do business in Texas.

11. Venue is proper in this district under 28 U.S.C. § 1400(b) because HP has committed and continues to commit acts of patent infringement in this district, including making, using, offering to sell, and/or selling Accused Products in this district, including by Internet sales and sales via retail and wholesale stores, and HP has a regular and established place of business in this district, including at 6080 Tennyson Pkwy Suite 400, Plano, TX 75024.

IV. FACTUAL ALLEGATIONS

A. The Asserted Patents

1. U.S. Patent 5,926,684

12. On July 20, 1999, the United States Patent and Trademark Office ("USPTO") duly and legally issued U.S. Patent No. 5,926,684 ("the '684 Patent") entitled "Image Forming Device Having Post-Processing Station Above the Image Forming Station" to a subsidiary of Sharp. Sharp assigned the '684 Patent to K.Mizra and that Assignment is recorded beginning at Reel/Frame No. 054223/0499 of the USPTO Assignment database. A true and correct copy of the '684 Patent is attached hereto as Exhibit A and incorporated herein, in its entirety, by reference.

13. The '684 Patent is directed to an image-forming device having an image formation unit, a postprocessing tray above the image formation unit, and a discharge tray. This orientation enables the device to be made compact in width with improved ease of operability. Claim 1 of the '684 Patent addresses these concepts and states:

1. An image-forming device comprising:

an image formation section, which forms images on sheets of recording paper;

a postprocessing device including (1) a stacking section, in which is temporarily stacked a plurality of sheets on which images have been formed by said image

formation unit, and (2) a postprocessing section, which performs postprocessing of the sheets stacked in said stacking section, said postprocessing device being provided directly above said image formation section;

discharge means, which discharge the sheets stacked in said stacking section; and

a discharge tray, which receives the sheets discharged by said discharge means.

14. Multiple HP MFPs that were offered for sale in the United States during the term of the '684 Patent met all limitations of Claim 1 of the '684 Patent. For example, the HP MFP model MFP E87640 had a Y1G00A inner finisher which acted as a postprocessing device including a stacking section and a postprocessing section (a stapler).

HP Color LaserJet Managed Flow E87640 A3 Color Laser MFP Printer
SALE \$3,500.00 \$4,500.00

Specifications What's Included Accessories

- HP Color LaserJet Managed Flow E87640
- 2 Trays and Stand
- **Inner Finisher**
- Average 30% consumables
- Power cord



15. The inner finisher was located directly above an image formation section.

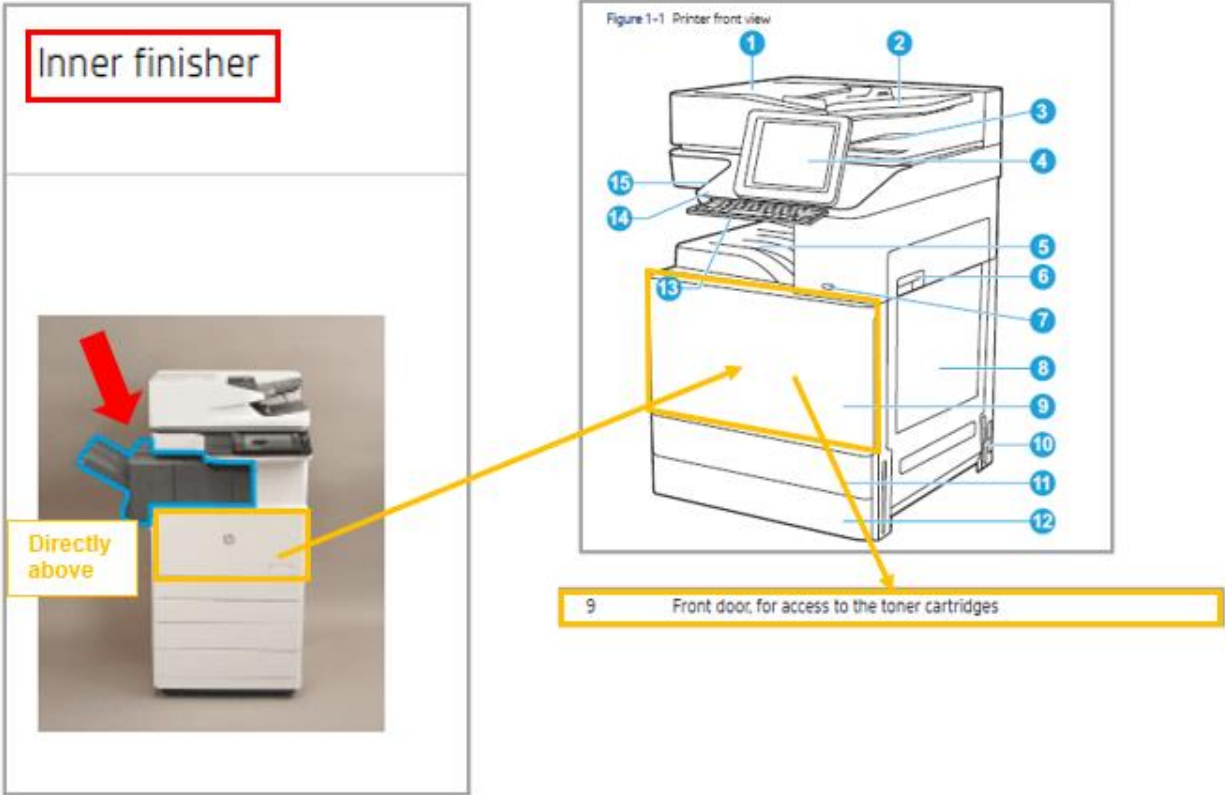

16. The MFP E87640 also included a discharge means and a discharge tray.

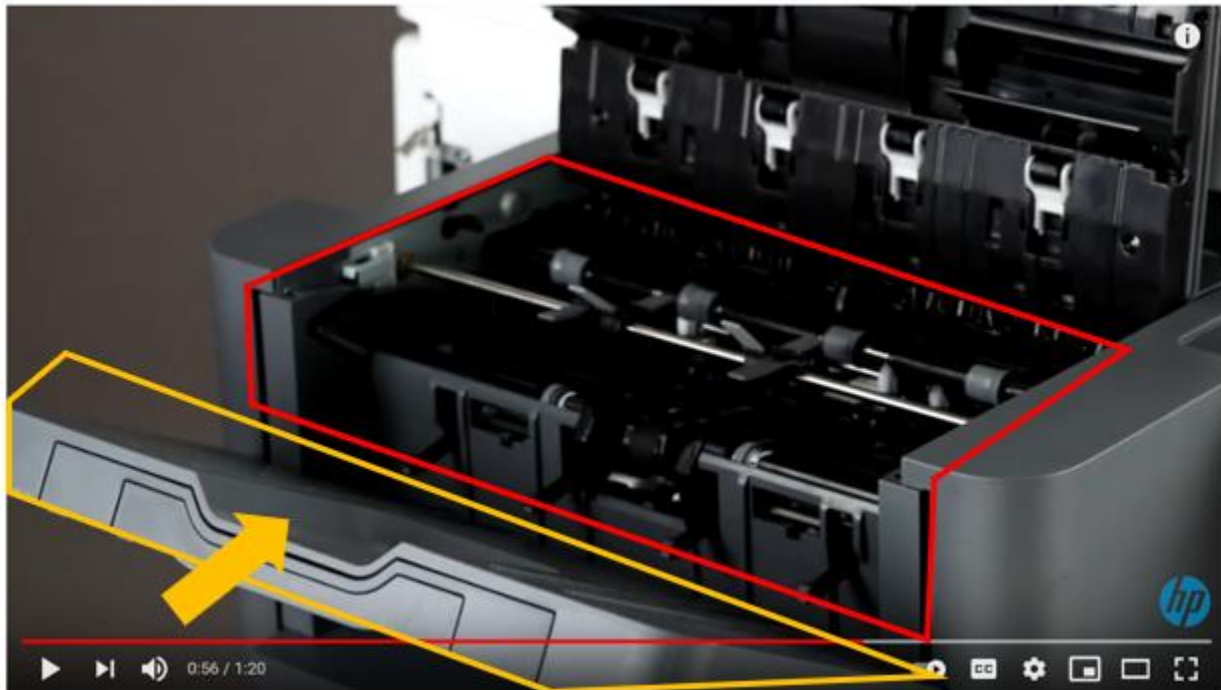

17. The MFP E87640 with the Y1G00A inner finisher was offered for sale in the United States by HP during the term of the '684 Patent. For example, an HP brochure dated 2016 advertised the MFP E87640 with the Y1G00A inner finisher for sale in the United States. *See* <https://www.reliableindiagroup.com/HPBrochures/A3%20LaserJet%20Product%20Family%20Brochure%20%E2%80%9312pp.pdf>.

2. U.S. Patent 7,064,874

18. On June 20, 2006, the USPTO duly and legally issued U.S. Patent No. 7,064,874 ("the '874 Patent") entitled "Both-Side Document Reading Apparatus and Both-Side Document Reading Method" to Sharp. Sharp assigned the '874 Patent to K.Mizra, and that Assignment is recorded beginning at Reel/Frame No. 054223/0499 of the USPTO Assignment database. A true and correct copy of the '874 Patent is attached hereto as Exhibit C and incorporated herein, in its entirety, by reference.

19. The '874 Patent discloses a both-side reading apparatus used, for example, in scanners, copiers, printers, facsimiles or the like, and a both-side document reading method. In one aspect of the systems and methods disclosed in the patent, an amount of the illumination light applied to the surfaces of a document is held constant until the reading operation at both the main and back surfaces of the document has been completed. This allows both sides of a document to be read under constant reading conditions and prevents errors or artifacts that occur from variable illumination or opposing light sources. Claim 18 of the '874 Patent addresses these concepts and states:

An image forming apparatus comprising a both-side document reading apparatus,
the both-side document reading apparatus comprising:

a first reading portion, provided with a first light source, for reading one side surface of a document by emitting light toward the one side surface of the document by the first light source; and

a second reading portion, provided with a second light source, for reading another side surface of the document by emitting light toward the other side surface of the document by the second light source,

wherein the first and second reading portions are arranged so that a reading region of the one side surface by the first reading portion is arranged on an upstream side from a reading region of the other side surface by the second reading portion in a document transport direction, and

wherein the first light source is turned off after the document has passed through the reading region of the second reading portion.

20. Multiple HP MFPs meet all limitations of Claim 18 of the '874 Patent. For example, HP MFP model HP OfficeJet Pro 8730 is an image forming apparatus, *i.e.*, printer, that contains a both-side document reader capable of duplex scanning:



HP OfficeJet Pro 8730 All-in-One Printer

★★★★☆ 4.0 (38) [Write a review](#)

- Print, Copy, Scan, Fax
- Print speed ISO: Up to 24 ppm black, up to 20 color
- **One-pass two-sided scanning** lightning fast two-sided printing at up to 20ppm, legal-size flatbed, mobile printing, USB document printing
- Instant Ink ready; High yield ink available.

21. The OfficeJet Pro 8730 contains a flatbed scanner that contains the claimed first reading portion and first light source. The scanner lamp of the OfficeJet Pro 8730 illuminates

the downward-facing side of a document by emitting light onto that document that is read by a charged coupled device ("CCD").



22. The claimed second reading portion of the OfficeJet Pro 8730 is housed in the automated document feeder ("ADF"). Within the ADF, an ADF CCD contains a second light source, a lamp, that emits light onto the other, upward-facing side of the document to read that surface.



Part Number: **D9L20A**
HP OfficeJet Pro 8730 All-in-One Printer

Web Price ?

Outright	OEM \$342.46	Recertified \$291.09	Refurbished \$222.60
-----------------	-------------------------------	---------------------------------------	---------------------------------------

D9L20A-ADF_SCANNER HP Inc.

ADF scanner (optical) assembly - includes the chassis assembly scanner lens assembly (includes the charge coupled device (ccd)) the scanning lamp ADF analog processor board and ADF inverter board - this is the lower assembly that scans copies documents.

D9L20A-SENSOR_ADF HP Inc.

Photo-sensor assembly - includes the sensor and mounting bracket - paper pickup roller home position sensor - activated by the sensor flag on the pickup roller assembly - mounts on the front frame of the ADF paper pickup assembly

23. As shown below, the OfficeJet Pro 8730 is designed such that sheets of paper to be duplex scanned are placed in the ADF tray from which they are fed by rollers into the ADF. By design, during duplex scanning, the document is transported in a single direction by the rollers— from the ADF tray, the document page is moved past the surface of the flatbed scanner and then up into the ADF and past the ADF CCD before being ejected into the ADF bin when scanning is complete. In this document page flow, the document is first scanned in a region above the flatbed scanner, where the downward-facing side of the document is read. This first region is upstream of a separate region where the other, upward-facing side of the document is read.

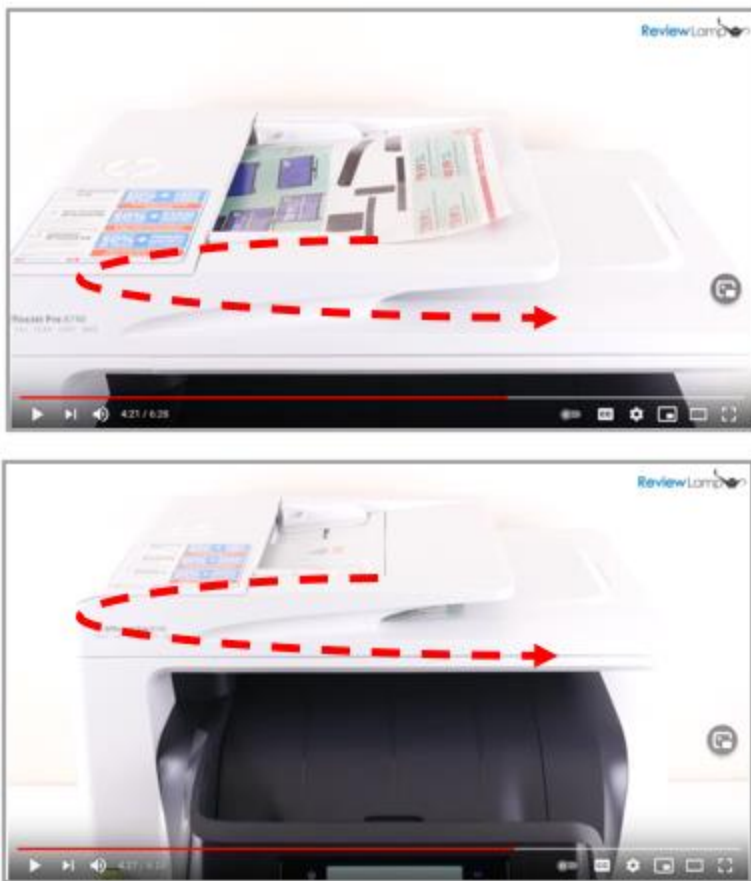

24. Thus, the document passes downstream as it travels from the ADF tray, through the first and then second reading regions, and into the ADF bin, with each side scanned sequentially. After the scanning is complete, the scanner lamp of the OfficeJet Pro 8730 turns off automatically.

3. U.S. Patent 7,449,274

25. On November 11, 2008, the USPTO duly and legally issued U.S. Patent No. 7,449,274 ("the '274 Patent") entitled "Toner for Electrostatic Image Development and Image Forming Method Using the Same" to Sharp. Sharp assigned the '274 Patent to K.Mizra and that Assignment is recorded beginning at Reel/Frame No. 054223/0499 of the USPTO Assignment database. A true and correct copy of the '274 Patent is attached hereto as Exhibit E and incorporated herein, in its entirety, by reference.

26. The '274 Patent is directed toward a composition of toner where certain percentages of the toner particles fall within or outside of specified sizes, and the toner also includes an additive. The '274 Patent toner composition has been shown to outperform other previously known toner compositions in a number of ways. Claim 1 of the '274 Patent states:

A toner for electrostatic image development, comprising toner particles in which not more than 13 percent by number of the toner particles have a particle diameter of smaller than 4 μm , not less than 20 percent by number of the toner particles have a particle diameter of 4 μm to 6 μm , not more than 2.0 percent by volume of the toner particles have a particle diameter of 16 μm or greater, wherein the toner particles have a volume average diameter of 4 μm to 9 μm and at least an external additive is added to the toner particles.

27. HP has made, used, sold, offered for sale, and/or imported toner cartridges that infringe at least Claim 1 of the '274 Patent. An exemplary infringing toner cartridge is the HP 116A toner cartridge, shown below:



28. The HP 116A toner cartridge contains toner for electrostatic image development using an HP printer or copier. An independent third-party analysis of the contents of the HP 116A toner cartridge revealed toner particles in which at most $100 - 94.6 = 5.4$ percent by number of the particles within the cartridge have a particle diameter smaller than $4 \mu\text{m}$, and at least 94.6 percent by number of the toner particles have a particle diameter of $4 \mu\text{m}$ or greater, as shown in the below table:

Particle Diameter μm	HP MFP179 _OEM Black _88.#m4 Number	Number % >	Volume μm^3 >	Volume % >
1	66483	100	9320909	100
2	66483	100	9320909	100
3	64973	97.7	9308640	99.9
4	62881	94.6	9255859	99.3
5	52797	79.4	8735561	93.7
6	34017	51.2	7075361	75.9
8	6515	9.80	2355787	25.3
10	389.1	0.59	259758	2.79
12	17.42	0.026	31079	0.33
15	6	0.0090	18959	0.20
17	4	0.0060	14400	0.15
20	0	0	0	0
25	0	0	0	0

29. The analysis further confirmed that the HP 116A toner cartridge comprises toner particles in which at least $94.6 - 51.2 = 43.4$ percent by number of toner particles have a diameter of $4 \mu\text{m}$ to $6 \mu\text{m}$, as shown in the below table:

Particle Diameter µm	HP MFP179 _OEM Black _88.#m4 Number	Number % >	Volume µm ³ >	Volume % >
1	66483	100	9320909	100
2	66483	100	9320909	100
3	64973	97.7	9308640	99.9
4	62881	94.6	9255859	99.3
5	52797	79.4	8735561	93.7
6	34017	51.2	7075361	75.9
8	6515	9.80	2355787	25.3
10	389.1	0.59	259758	2.79
12	17.42	0.026	31079	0.33
15	6	0.0090	18959	0.20
17	4	0.0060	14400	0.15
20	0	0	0	0
25	0	0	0	0

30. The analysis further confirmed that the HP 116A toner cartridge comprises toner particles in which at most 0.20 percent by volume of the toner particles have a particle diameter of 15 µm or greater, as shown in the below table:

Particle Diameter µm	HP MFP179 _OEM Black _88.#m4 Number	Number % >	Volume µm ³ >	Volume % >
1	66483	100	9320909	100
2	66483	100	9320909	100
3	64973	97.7	9308640	99.9
4	62881	94.6	9255859	99.3
5	52797	79.4	8735561	93.7
6	34017	51.2	7075361	75.9
8	6515	9.80	2355787	25.3
10	389.1	0.59	259758	2.79
12	17.42	0.026	31079	0.33
15	6	0.0090	18959	0.20
17	4	0.0060	14400	0.15
20	0	0	0	0
25	0	0	0	0

31. The analysis further confirmed that the HP 116A toner cartridge comprises toner particles having a volume mean diameter of 7.089 µm and a volume median diameter of 7.001 µm, as the below graph confirms:

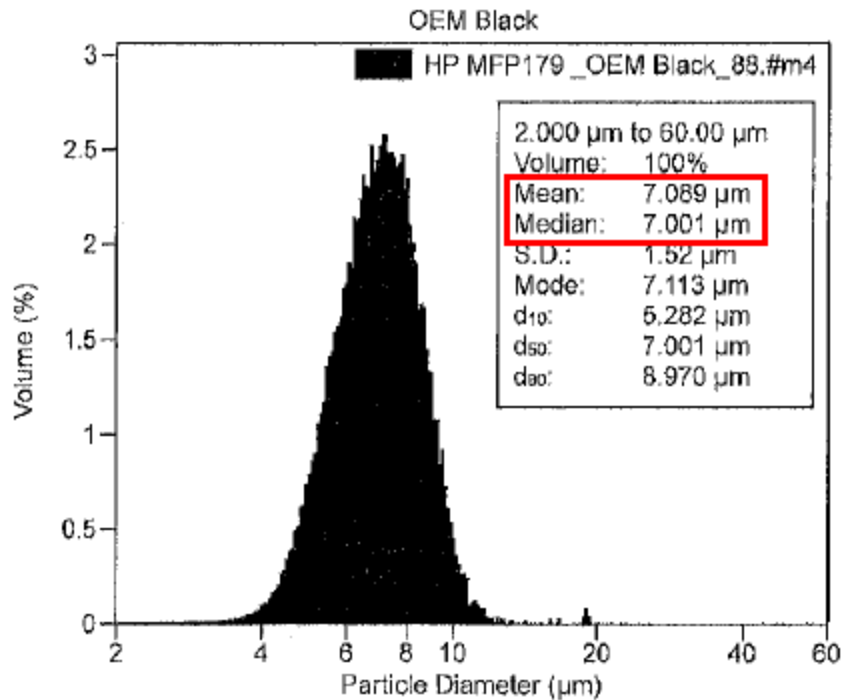

32. Finally, analysis confirmed that the HP 116A cartridge comprises toner in which an external additive comprising SiO₂ (silica) and TiO₂ (titanium oxide) is added to the toner particles. Specifically, the toner includes silica and titanium dioxide particles, which are identified as additives in the specification of the '274 Patent, as shown in the following analysis graphs:

HP 116A: Si2p

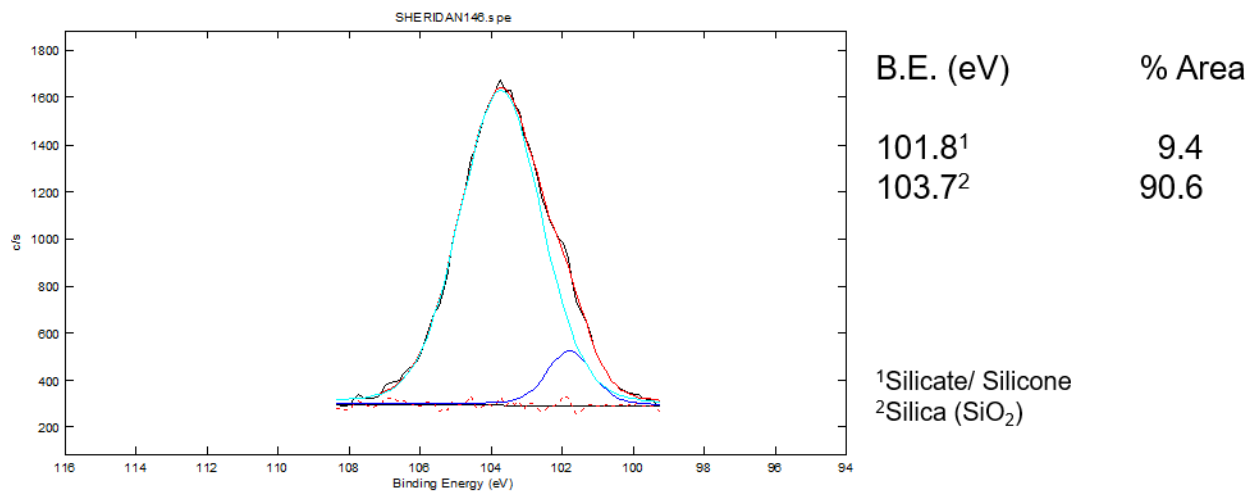

HP 116A: Ti2p

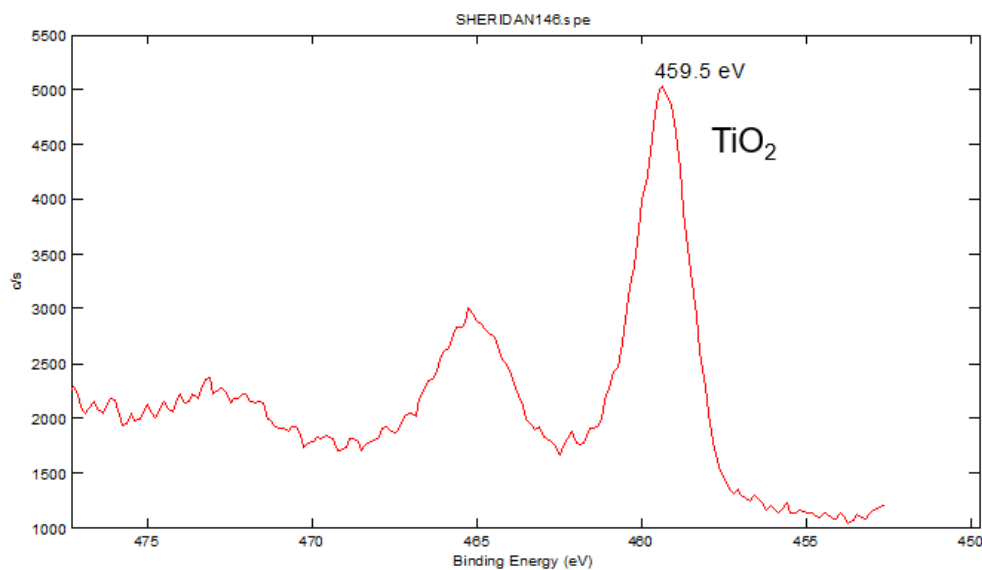

4. U.S. Patent 7,852,504

33. On December 14, 2010, the USPTO duly and legally issued U.S. Patent No. 7,852,504 ("the '504 Patent") entitled "Image Forming Device, Print Job Transmission Device, Data Management Device, Program, Storage Medium and Method for Supplying Print Sheet" to Sharp. Sharp assigned the '504 Patent to K.Mizra and that Assignment is recorded beginning at Reel/Frame No. 054223/0499 of the USPTO Assignment database. A true and correct copy of the '504 Patent is attached hereto as Exhibit G and incorporated herein, in its entirety, by reference.

34. The '504 Patent is directed to printers and copiers with multiple paper sheet options. The '504 Patent discloses paper specification preference conditions and indicators and the selection of a paper tray in accordance with selected print condition priorities. Claim 1 of the '504 Patent is directed to at least some of these concepts and states:

An image forming device, comprising:

a transmission/reception section which functions as an interface to a network;

a control section for generating a tray selection signal in accordance with a print job inputted to the transmission/ reception section, said print job including a print condition indicative of a condition for printing; and

a sheet feeding tray section, having a plurality of sheet trays capable of storing sheets of different types therein, which supplies a sheet from one of the sheet trays that has been selected in accordance with the tray selection signal transmitted from the control section, wherein said control section includes:

an operation control section for extracting the print condition from the print job and for obtaining an order table, indicative of a priority based on the print condition that has been extracted, from setting information, indicative of a sheet type priority indicating a type of paper corresponding to the print condition, wherein the order table specifies one of the sheet trays; and

a tray selection section for generating the tray selection signal for selecting one of the sheet trays, in accordance with the order table transmitted from the operation control section.

35. Multiple HP MFPs meet all limitations of Claim 1 of the '504 Patent. For example, the HP MFP product model PageWide Pro 750 is an image forming device capable of executing print jobs received over a network. The PageWide Pro 750 has a series of internal or attached sheet trays that can feed paper of various sizes and characteristics based on the settings of a print job received over a connected network. By using these trays, the PageWide Pro 750 supports printing on multiple sheet types and sizes, as the following describes:

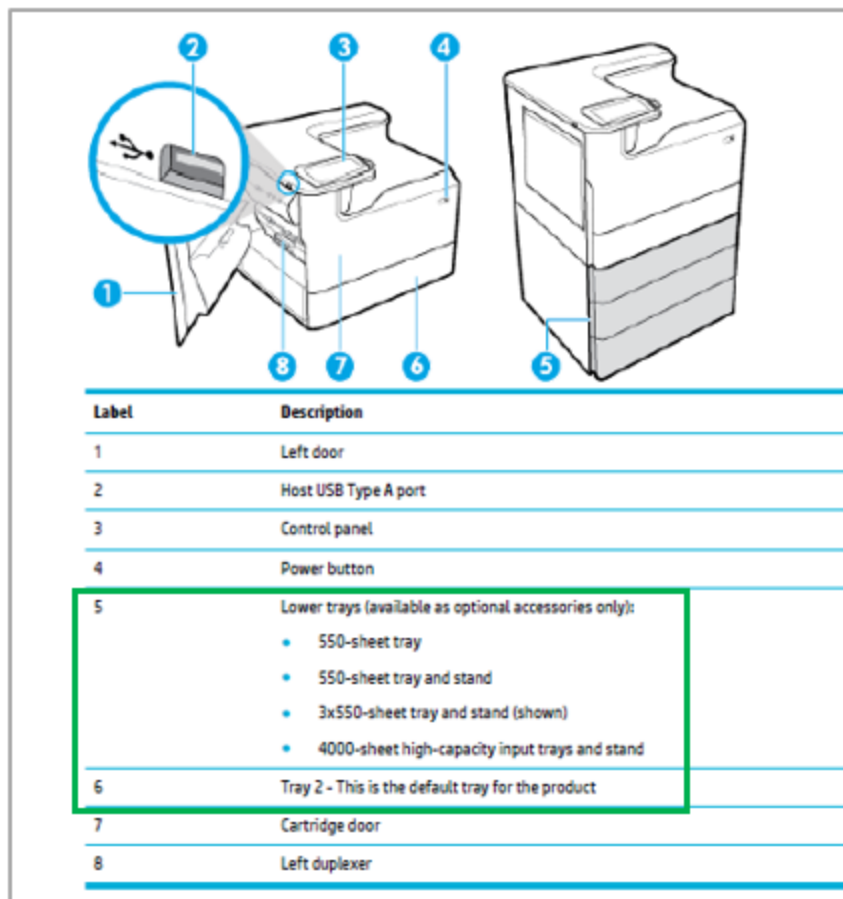

36. The specific sheet tray that is triggered to feed a sheet of paper for printing is based on the characteristics of an assigned print job. The PageWide Pro 750 contains print preferences within its print settings, which can be configured by the user. These preferences form a hierarchical table of print preferences used to select the appropriate sheet based on the available sheets and the conditions extracted from the received print job. The PageWide Pro 750's print table determines the prioritized sheet and sends a signal to the corresponding tray to feed the appropriate sheet paper for printing. Upon receipt of the tray selection signal, the tray responsive to the paper specifications commences a sheet-feeding action. In this way, the PageWide Pro 750 functions as claimed, as shown below:

Configure trays

Tray configuration on the control panel typically occurs during initial setup. Correct tray management is essential for making the best use of the product. It is advisable to verify that the configuration settings are correct if printing issues occur.

This table describes the correct settings, for the printer software and printer configuration, of some common print jobs.

I want to...	Follow these steps	The product then does this...
Set the product to automatically select the correct tray.	<ul style="list-style-type: none"> • Do one of the following: <ul style="list-style-type: none"> — Windows: Under Paper Source, select Printer Auto Select. — OS X: Under Paper Feed, select Auto Select. Then, select the correct media size and type for the print job. • Printer configuration: Under Settings, on the Paper Setup screen, the media size and type for each tray must match what is actually loaded in the tray. 	<p><u>Queries the trays and selects the first one with the correct media size and type</u>, starting with the default tray.</p> <p>If Tray 1 contains media and its tray configuration is set to Any Size and Any Type, the product prints to this tray first.</p>
Print from Tray 1.	<ul style="list-style-type: none"> • Do one of the following: <ul style="list-style-type: none"> — Windows: Under Paper Source, select Printer Auto Select. — OS X: Under Paper Feed, select Auto Select. • Printer configuration: Under Settings, on the Paper Setup screen, for Tray 1 Paper Size must be set to Any Size, and Paper Type must be set to Any Type. 	<p><u>Prints from Tray 1</u> until the tray is empty. It then queries the other trays and prints from the first one with the correct media size and type.</p>

5. U.S. Patent 9,769,342

37. On September 19, 2017, the USPTO duly and legally issued U.S. Patent No. 9,769,342 ("the '342 Patent") entitled "Electric Apparatus" to Sharp. Sharp assigned the '342 Patent to K.Mizra and that Assignment is recorded beginning at Reel/Frame No. 054223/0499 of the USPTO Assignment database. A true and correct copy of the '342 Patent is attached hereto as Exhibit I and incorporated herein, in its entirety, by reference.

38. The '342 Patent is directed to an electric apparatus MFPs, that has a control panel user interface that can exist in both active and power save states. The '342 Patent discloses a device and method that "wakes" the electrical device from a power save state if the device is in hibernation or sleep mode or initiates some user function if the device is already in its operational state. For

example, a "go" button is disclosed as being on a printer's user interface and can either initiate a printing job if the printer is in an operational state, or wake up the machine if it is in a power save mode.

39. Claim 1 of the '342 Patent is directed to at least some of these concepts and states:

An electric equipment including a reception unit configured to receive an instruction relating to functions of the electric equipment by an operation of a user and having operation states of a power conserving state in which power required for performing the functions thereof is limited and a normal state in which the power is not limited, the electric equipment comprising:

a signal output unit configured to output signals of different levels depending on the operation state when the reception unit receives the instruction from the user; and

a control signal unit configured to selectively output a return signal relating to a return to the normal state or an execution signal relating to an execution of a function corresponding to the instruction received by the reception unit, based on the signal output from the signal output unit.

40. Multiple HP MFPs meet all limitations of the Claim 1 of the '342 Patent. For example, the HP MFP model OfficeJet Pro 8730 is an electronic device having a control panel capable of receiving instructions related to functions of the MFP and has both power conservation and normal power operating states. The control panel has a plurality of physical buttons as well as a touchscreen through which it may receive instructions:

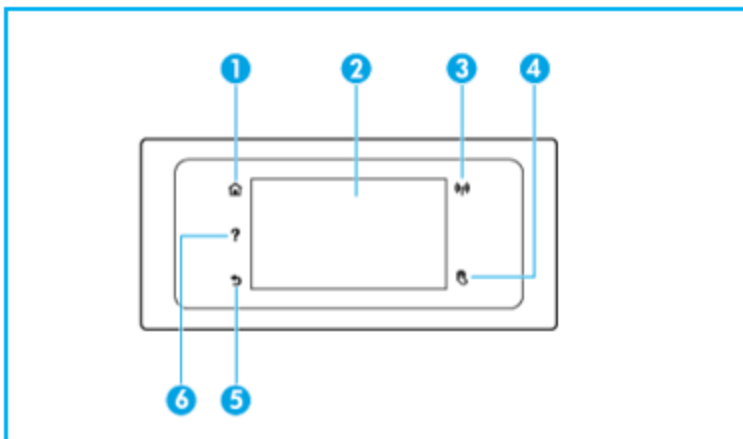

41. When the unit is in a low power state – such as sleep – depressing the power button or touching the touchscreen returns the unit to the normal operating power state. However, when the unit is in the normal operating state, depressing the power button or touching the touchscreen has various function execution purposes, such as powering down the device, selecting menu options, or scrolling through the menu, as explained below:

Label	Name and Description
1	Home button: Returns to the home screen from any other screen.
2	Control panel display: Touch the screen to select menu options, or scroll through the menu items. For information about the icons that appear on the display, see Control panel display icons .

6. U.S. Patent 10,018,938

42. On July 10, 2018, the USPTO duly and legally issued U.S. Patent No. 10,018,938 ("the '938 Patent") entitled "Network System Comprising Customer Replaceable Unit" to Sharp. Sharp assigned the '938 Patent to K.Mizra and that Assignment is recorded beginning at

Reel/Frame No. 054223/0499 of the USPTO Assignment database. A copy of the '938 Patent is attached hereto as Exhibit K and incorporated herein, in its entirety, by reference.

43. The '938 Patent is directed to a server connected to a networked multifunction printer having a consumable replaceable unit, such as a toner cartridge. When the server obtains operation information from the printer, it can determine the remaining level of toner in the printer, and can send toner reorder information when the remaining toner reaches a set threshold.

44. Claim 3 of the '938 Patent is directed to at least some of these concepts and states:

A system comprising:

an accumulation portion configured to accumulate an operation performance for calculating an amount of remaining toner held in a toner supply container of a developing device attached to an image forming apparatus;

a calculation portion configured to calculate the amount of remaining toner held in the toner supply container based on the operation performance accumulated by the accumulation portion;

a determination portion configured to determine whether the amount of remaining toner reaches a threshold; and

a sending portion configured to send order information when it is determined that the amount of remaining toner reaches the threshold.

45. HP's servers in combination with compatible HP MFPs meet all limitations of Claim 3 of the '938 Patent. For example, Instant Ink service allows HP to monitor its customers' supplies of toner in their HP MFPs and automatically initiate replenishment orders, as shown below:



We deliver the right ink, right on time, for less.

How it works

- 1**
PICK YOUR PLAN
5 plans to choose from based on how many pages you print each month.
- 2**
GET INK BEFORE YOU RUN OUT^{1,8}
We send HP Original Ink directly to your door. Cartridge recycling and shipping included.
- 3**
ENJOY AN EASIER WAY TO PRINT
No commitment or annual fee—cancel anytime.³

No, you'll never run out of ink again.

Your printer tells us that you're low on ink, so we know when to send you more – delivered straight to your door.

You won't get cartridges every month, but you will always have ink when you need it. Your monthly fee pays for ink, shipping, and recycling.

46. The HP Instant Ink Service collects information from HP MFPs, about device usage and supplies and exchanges such information over a network with HP:

HP INSTANT INK TERMS OF SERVICE

1. DATA COLLECTION.

- Personal data. The collection and use of Data shall be governed by the HP Privacy Statement located at www.hp.com/go/privacy.
- Remote Monitoring. Your purchase of the Instant Ink Service indicates Your authorization for HP to (1) remotely monitor Your printer page count and Your ink status, and (2) Your usage of the Instant Ink Service to prevent unauthorized use of Your account and to improve Your experience with HP products and services. Remote monitoring includes provision to HP of Your ink levels, page counts, types of documents printed (e.g., Word, PowerPoint, pdf, jpeg, etc.), types of devices that initiated print jobs, printer serial number, cartridge information (e.g. HP Original ink status, and whether the cartridge was new or used at the time of its last insertion into the printer), and other similar types of metrics related to your Instant Ink Service as may be added by HP from time to time.

47. Nearly all new HP inkjet printers support Instant Ink. An HP MFP using Instant Ink is an image forming device that, using toner, executes print jobs through an image forming apparatus and has a controller board that manages internal operations. Recording toner usage through the device's sensor and control, the HP MFP collects and reports up-to-date metrics and

page counts to HP as the information accumulates. HP receives data about the HP MFP's operation and calculates the amount of remaining toner supply. HP is then able to determine when the amount of remaining toner reaches a threshold at which resupply will become necessary:

When will HP send replacement cartridges?

HP will send you replacement cartridges before you run out of ink. When your enrolled printer is connected to the Internet, your printer automatically orders ink for you because it knows when you are low on ink. Your printer orders ink when your cartridges have enough ink to print twice the number of average pages included in your monthly plan. Cartridges are sent using standard shipping, so they might take up to 10 days to arrive, however, your printer will take shipping time and regular ink usage into account when it orders your ink. Customers with high volume print needs may call Support to request expedited shipping, if they feel their cartridges will not arrive before running out of ink. (Additional shipping charges may apply.)

Your Printer Needs to be Connected to the Internet. In order to be able to use the Instant Ink Service in an uninterrupted manner, You agree to maintain connectivity of Your Printer to the Internet and to not remove or disable any remote monitoring software or functionality on Your printer; such Internet service is not provided by HP and must be separately obtained and paid for by You. Please check with Your Internet provider for information on possible Internet data usage charges and any other applicable charges. You are responsible for obtaining and maintaining, at Your sole expense, all equipment and services needed to access and use the Instant Ink Service. If Your printer is not connected to the Internet, then the Instant Ink-activated Cartridges will be disabled and You will not be able to use them to print; however, You will continue to be charged for the Instant Ink Service as described in Section 7 ("Paying for Your Instant Ink Service"). In order to reactivate disabled cartridges, You will need to contact HP Customer Support at the HP Customer Support Telephone number noted at the beginning of this Agreement or www.hp.com/go/instantinksupport for assistance. Failure to connect Your printer to the Internet will also impact HP's ability to send certain notices to You (including but not limited to those described in Section 7 ("Paying for Your Instant Ink Service")) and will impact the timeliness of Your being billed for the Instant Ink Service.

48. When a device's supply level reaches that threshold, it triggers the Instant Ink System to submit a replenishment order to HP. The technology necessary for HP's Instant Ink service to occur – the accumulation and calculation of usage data, and the server's ability to initiate the proper workflow in response to this data – is disclosed in and claimed by at least Claim 3 of the '938 Patent.

49. The claims of the '938 Patent are not directed to an abstract idea. Rather, the '938 Patent presents a technical solution to a hardware problem. The '938 Patent is directed to previously existing problems with toner cartridges used in MFPs. The hardware environment relevant to the '938 Patent includes several physical components, as illustrated in Figure 5 from the patent:

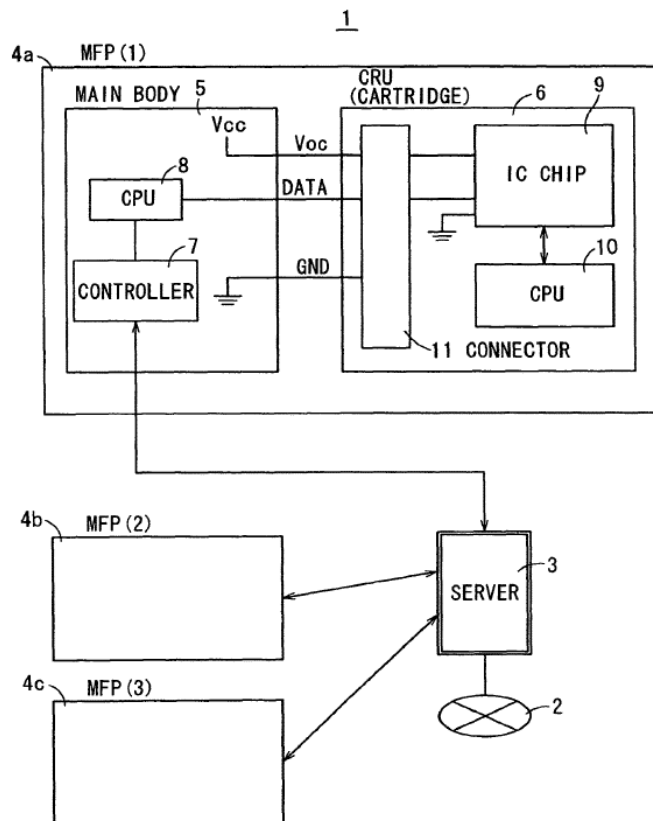
FIG. 5 PRIOR ART

These include one or more MFPs having one or more toner cartridges, identified as "CRUs" (customer replaceable units). The CRUs are electronic devices that include CPUs and IC chips that are in communication with the main body of an MFP, which in turn is connected to a server. The logic within the CRU is stored on a CRU memory, referred to as a "CRUM." Exhibit K ('938 Patent) at 1:29-32

50. The '938 Patent is directed toward improvements in the performance and security of the system depicted in Figure 5. In particular, the '938 Patent recognizes the limitations of prior art approaches for "stor[ing] information on ordering into a CRUM in advance and, when a CRU reaches the limits of use through operation, provid[ing] the order information" to a user, as well as "stor[ing] a software code upgrade into a CRUM in advance so that the operator can update a

software code without the need for calling a field engineer or the like." *Id.* at 2:19-32. Letting the prior art CRUM store the information created a security risk that counterfeit products could be manufactured by analyzing and reproducing the information stored in the prior art CRUM. *Id.* at 2:34-41. The '938 Patent also recognized that memory storage limits on local CRUMs may create difficulties in storing large amounts of information. *Id.* at 2:41-45

51. The solution to these problems, as described and claimed by the '938 Patent, involves migrating the functions of the CRUM to a remote server, thereby enhancing the operational efficiency and security of the network. As the '938 Patent explains:

An object of the invention is to provide a network system comprising a customer replaceable unit having an excellent security function for operation information which system can realize improvement of the use efficiency of operation information for making a customer replaceable unit operate and reduction in costs.

Id. at 8:30-36. The '938 Patent goes on to explain how the server performs the function of calculating when a CRU should be replaced. For example, the specification states:

In the server 22, the amount of remaining toner held in the toner supply container is calculated from the accumulated operation performance, namely, the number of rotations of the toner supply roller, and it is determined whether the operation performance has reached the first and second threshold values or not.

Id. at 8:30-36. The patent's specification also highlights how this improves the security of the system and the operation of the CRUM:

According to the invention, in response to the detection result of the end of communication between the main-body communicating portion and the unit communicating portion 45 by the communication end detecting portion, that is, when an operation of the apparatus main body and the customer replaceable unit based on information communication ends, the operation information of the customer replaceable unit stored in the main-body storing portion is erased by the information erasing means. Consequently, the operation information necessary for the operation of the customer replaceable unit does not remain in either the apparatus main body or the customer replaceable unit, but remains only in the server. Therefore, it is possible to prevent information leakage, and exhibit a high security function.

Id. at 3:43-56. In other words, because operational information is maintained only in a remote server, the risk of improperly accessing and using the information previously housed on a remote CRUM, *e.g.*, to manufacture counterfeit products, is minimized.

52. In sum, the '938 Patent describes a technical solution (calculation and storage of information at a server rather than a local device) to a hardware problem (securely and efficiently maintaining appropriate toner levels in an MFP). Accordingly, the '938 Patent is not directed to an abstract idea.

53. The claims of the '938 Patent also contain an inventive concept and thus the claimed invention is not well-known, routine or conventional. The claims of the '938 Patent do not recite generic components, but rather non-generic features such as an image forming apparatus containing a CRU, neither of which are components of a generic computer. The claims of the '938 Patent are tied to specific machines – MFPs containing CRUs – and are thus not properly considered generic.

54. Indeed, the USPTO acknowledged the eligibility of the claimed invention of the '938 Patent. During prosecution of U.S. Patent Application No. 11/506,082 ("the '082 Application"), the parent application of the '938 Patent, the Examiner ultimately determined that claims including the main body, CRU, server, and network were ineligible under 35 U.S.C. § 101 ("Section 101"). Exhibit M ('082 App.), 3/4/2016 OA at 4-18. The Examiner initially asserted that the invention was "directed to an abstract idea including a method of organizing human activities using a generic computer without reciting significantly more than the abstract idea." *Id.*, 6/3/2016 Amendment at 9. In response, the Applicant explained why the Examiner's conclusion was incorrect.

55. First, the Applicant stated that the claimed invention includes "a server, an imaging forming apparatus, and a customer replaceable unit (CRU)," and thus is "unequivocally not a method of organizing human activities." *Id.* The Applicant also refuted the Examiner's assertion that the invention was mere "data gathering," explaining that this improperly described the invention "at a high level of abstraction while ignoring [claimed] limitation[s]." *Id.* Rather, the Applicant explained that the "recited network system, method, and apparatus include an image forming apparatus containing a customer replaceable unit (CRU), neither of which are components of a generic computer." *Id.* The Applicant then referenced the specification's description of "the unique advantages and benefits achieved by Applicant's claimed invention." *Id.* at 9-10. In response, the Examiner deemed the Applicant's arguments "persuasive" and withdrew the rejection under Section 101. *Id.*, 9/1/2006 OA at 26.¹

56. Although the claims of the '938 Patent are different from the claims at issue in the parent application, they nonetheless recite a "server" and an "image forming apparatus" as in the '082 Application, as well as the critical CRU. The specifications are also the same. Thus, the Applicant's arguments from the '082 Application, and the Examiner's conclusion as to Section 101 eligibility, apply with equal force to the '938 Patent.

V. FIRST CLAIM FOR RELIEF
(Count I – Patent Infringement of U.S. Patent No. 5,926,684)

57. Plaintiff repeats and re-alleges the allegations above in Paragraphs 1 – 17 as if fully set forth herein.

¹ The Examiner maintained additional grounds of rejection and the '082 Application was abandoned.

58. The '684 Patent includes 43 claims. HP directly infringed one or more of these claims without authority of Plaintiff by importing, manufacturing, using, offering for sale, and selling products and systems during the term of the '684 Patent.

59. More specifically and without limitation, HP directly infringed, either literally or under the doctrine of equivalents, at least Claim 18 of the '684 Patent by importing, manufacturing, using, offering for sale, and selling during the term of the '684 Patent Accused Products, including but not limited to the HP MFP E87640 as shown in the '684 Patent Preliminary Claim Chart, attached as Exhibit B and incorporated herein by reference.

60. HP is thus liable for direct infringement of the '684 Patent pursuant to 35 U.S.C. § 271(a).

61. HP's acts of infringement have occurred within this District and elsewhere throughout the United States.

62. HP is liable to Plaintiff in an amount that adequately compensates it for HP's infringement in an amount that is not less than a reasonable royalty, together with interest and costs as fixed by this Court under 35 U.S.C. § 284.

63. Plaintiff has been damaged and will suffer additional damages and irreparable harm unless HP is enjoined from further infringement under 35 U.S.C. § 283.

VI. SECOND CLAIM FOR RELIEF
(Count II – Patent Infringement of U.S. Patent No. 7,064,874)

64. Plaintiff repeats and re-alleges the allegations above in Paragraphs 1 – 11 and 18 – 24 as if fully set forth herein.

65. The '874 Patent includes 18 claims. HP directly infringes one or more of these claims without authority of Plaintiff by importing, manufacturing, using, offering for sale, and selling products and systems.

66. More specifically and without limitation, HP has been and is directly infringing, either literally or under the doctrine of equivalents, at least Claim 18 of the '874 Patent by importing, manufacturing, using, offering for sale, and selling Accused Products, including but not limited to the HP OfficeJet Pro 8730 as shown in the '874 Patent Preliminary Claim Chart, attached as Exhibit D and incorporated herein by reference.

67. HP is thus liable for direct infringement of the '874 Patent pursuant to 35 U.S.C. § 271(a).

68. HP's acts of infringement have occurred within this District and elsewhere throughout the United States.

69. HP is liable to Plaintiff in an amount that adequately compensates it for HP's infringement in an amount that is not less than a reasonable royalty, together with interest and costs as fixed by this Court under 35 U.S.C. § 284.

70. Plaintiff has been damaged and will suffer additional damages and irreparable harm unless HP is enjoined from further infringement under 35 U.S.C. § 283.

VII. THIRD CLAIM FOR RELIEF
(Count III – Patent Infringement of U.S. Patent No. 7,449,274)

71. Plaintiff repeats and re-alleges the allegations above in Paragraphs 1 – 11 and 25 – 32 as if fully set forth herein.

72. The '274 Patent includes 7 claims. HP directly infringes one or more of these claims without authority of Plaintiff by importing, manufacturing, using, offering for sale, and selling products and systems.

73. More specifically and without limitation, HP has been and is directly infringing, either literally or under the doctrine of equivalents, at least Claim 1 of the '274 Patent by importing, manufacturing, using, offering for sale, and selling Accused Products, including but not limited to

the HP 116A Toner Cartridge as shown in the '274 Patent Preliminary Claim Chart, attached as Exhibit F and incorporated herein by reference.

74. HP is thus liable for direct infringement of the '274 Patent pursuant to 35 U.S.C. § 271(a).

75. HP's acts of infringement have occurred within this District and elsewhere throughout the United States.

76. HP is liable to Plaintiff in an amount that adequately compensates it for HP's infringement in an amount that is not less than a reasonable royalty, together with interest and costs as fixed by this Court under 35 U.S.C. § 284.

77. Plaintiff has been damaged and will suffer additional damages and irreparable harm unless HP is enjoined from further infringement under 35 U.S.C. § 283.

VIII. FOURTH CLAIM FOR RELIEF
Count IV – Patent Infringement of U.S. Patent No. 7,852,504)

78. Plaintiff repeats and re-alleges the allegations above in Paragraphs 1 – 11 and 33 – 36 as if fully set forth herein.

79. The '504 Patent includes 21 claims. HP directly infringes one or more of these claims without authority of Plaintiff by importing, manufacturing, using, offering for sale, and selling products and systems.

80. More specifically and without limitation, HP has been and is directly infringing, either literally or under the doctrine of equivalents, at least Claim 1 of the '504 Patent by importing, manufacturing, using, offering for sale, and selling Accused Products, including but not limited to the PageWide Pro 750 as shown in the '504 Patent Preliminary Claim Chart, attached as Exhibit H and incorporated herein by reference.

81. HP is thus liable for direct infringement of the '504 Patent pursuant to 35 U.S.C. § 271(a).

82. HP's acts of infringement have occurred within this District and elsewhere throughout the United States.

83. HP is liable to Plaintiff in an amount that adequately compensates it for HP's infringement in an amount that is not less than a reasonable royalty, together with interest and costs as fixed by this Court under 35 U.S.C. § 284.

84. Plaintiff has been damaged and will suffer additional damages and irreparable harm unless HP is enjoined from further infringement under 35 U.S.C. § 283.

IX. FIFTH CLAIM FOR RELIEF
(Count V – Patent Infringement of U.S. Patent No. 9,769,342)

85. Plaintiff repeats and re-alleges the allegations above in Paragraphs 1 – 11 and 37 – 41 as if fully set forth herein.

86. The '342 Patent includes 3 claims. HP directly infringes one or more of these claims without authority of Plaintiff by importing, manufacturing, using, offering for sale, and selling products and systems.

87. More specifically and without limitation, HP has been and is directly infringing, either literally or under the doctrine of equivalents, at least Claim 1 of the '342 Patent by importing, manufacturing, using, offering for sale, and selling the Accused Products, including but not limited to the OfficeJet Pro 8730 as shown in the '342 Patent Preliminary Claim Chart, attached as Exhibit J and incorporated herein by reference.

88. HP is thus liable for direct infringement of the '342 Patent pursuant to 35 U.S.C. § 271(a).

89. HP's acts of infringement have occurred within this District and elsewhere throughout the United States.

90. HP is liable to Plaintiff in an amount that adequately compensates it for HP's infringement in an amount that is not less than a reasonable royalty, together with interest and costs as fixed by this Court under 35 U.S.C. § 284.

91. Plaintiff has been damaged and will suffer additional damages and irreparable harm unless HP is enjoined from further infringement under 35 U.S.C. § 283.

X. SIXTH CLAIM FOR RELIEF
(Count VI – Patent Infringement of U.S. Patent No. 10,018,938)

92. Plaintiff repeats and re-alleges the allegations above in Paragraphs 1 – 11 and 42 – 56 as if fully set forth herein.

93. The '938 Patent includes 4 claims. HP directly infringes one or more of these claims without authority of Plaintiff by importing, manufacturing, using, offering for sale, and selling products, systems and services.

94. More specifically and without limitation, HP has been and is directly infringing, either literally or under the doctrine of equivalents, at least Claim 3 of the '938 Patent by importing, manufacturing, using, offering for sale, and selling Accused Products, including but not limited to Instant Ink and compatible HP MFPs as shown in the '938 Patent Preliminary Claim Chart, attached as Exhibit L and incorporated herein by reference.

95. HP is thus liable for direct infringement of the '938 Patent pursuant to 35 U.S.C. § 271(a).

96. HP is liable to Plaintiff in an amount that adequately compensates it for HP's acts of infringement have occurred within this District and elsewhere throughout the United States.

97. HP's infringement in an amount that is not less than a reasonable royalty, together with interest and costs as fixed by this Court under 35 U.S.C. § 284.

98. Plaintiff has been damaged and will suffer additional damages and irreparable harm unless HP is enjoined from further infringement under 35 U.S.C. §283.

XI. PRAYER FOR RELIEF

K.Mizra requests that the Court find in its favor and against HP, and that the Court grant K.Mizra the following relief:

A. Judgment that one or more claims of the Asserted Patents have been infringed, either literally and/or under the doctrine of equivalents, by HP;

B. Ordering that HP, its officers, directors, agents, servants, employees, privies, representatives, attorneys, parent and subsidiary corporations or other related entities, successors, assigns, licensees, retail distributors, and all persons in active concert or participation with any of them, be preliminary and permanently enjoined from further acts of infringement of the unexpired Asserted Patents;

C. Awarding damages in an amount to be proven at trial, but in no event less than a reasonable royalty, for HP's infringement;

D. Judgment that HP account for and pay to K.Mizra all damages to, including a reasonable royalty, and costs incurred by K.Mizra because of HP's infringing activities and other conduct complained of herein, including an award of all increased damages to which K.Mizra is entitled under 35 U.S.C. § 284;

E. Declaring this an exceptional case and awarding K.Mizra its attorneys' fees and costs in accordance with 35 U.S.C. § 285;

F. Pre-judgment and post-judgment interest on the damages caused to K.Mizra by reason of HP's infringing activities and other conduct complained of herein; and

G. Such other and further relief as the Court may deem just and proper under the circumstances.

XII. DEMAND FOR JURY TRIAL

K.Mizra requests a trial by jury pursuant to Fed. R. Civ. P. 38.

Dated: June 22, 2021.

Respectfully submitted,

/s/ Michael C. Smith

Michael C. Smith
Michael.Smith@solidcounsel.com
Scheef & Stone, LLP
113 East Austin Street
Marshall, Texas 75670
Telephone: 903-938-8900

Robert R. Brunelli
CO State Bar No. 20070
rbrunelli@sheridanross.com
Patricia Y. Ho (to be admitted *pro hac vice*)
CO State Bar No. 38013
pho@sheridanross.com
Matthew C. Holohan
CO State Bar No. 40996
mholohan@sheridanross.com
Matthew C. Miller (to be admitted *pro hac vice*)
CO State Bar No. 41019
mmiller@sheridanross.com
SHERIDAN ROSS P.C.
1560 Broadway, Suite 1200
Denver, Colorado 80202
Telephone: (303) 863-9700
Facsimile: (303) 863-0223
litigation@sheridanross.com

Counsel for Plaintiff K.Mizra LLC