

**IN THE UNITED STATES DISTRICT COURT
FOR THE WESTERN DISTRICT OF TEXAS
WACO DIVISION**

AMERICAN PATENTS LLC,

Plaintiff,

v.

LEGRAND SA D/B/A/ LEGRAND,
SHANGHAI LEGRAND ELECTRICAL
CO. LTD., AND LEGRAND NORTH
AMERICA, LLC,

Defendants.

CIVIL ACTION NO. 6:21-cv-1333

ORIGINAL COMPLAINT FOR
PATENT INFRINGEMENT

JURY TRIAL DEMANDED

ORIGINAL COMPLAINT FOR PATENT INFRINGEMENT

Plaintiff American Patents LLC (“American Patents” or “Plaintiff”) files this original complaint against Defendants Legrand SA d/b/a Legrand, Shanghai Legrand Electrical Co. Ltd., and Legrand North America, LLC (collectively, “Legrand” or “Defendants”), alleging, based on its own knowledge as to itself and its own actions and based on information and belief as to all other matters, as follows:

PARTIES

1. American Patents is a limited liability company formed under the laws of the State of Texas, with its principal place of business at 2325 Oak Alley, Tyler, Texas, 75703.
2. Legrand SA d/b/a Legrand is a societe anonyme duly organized and existing under the laws of France having a place of business at 128, avenue du Marechal de Lattre de Tassigny, 87000 Limoges, France.

3. Shanghai Legrand Electrical Co. Ltd. is a company duly organized and existing under the laws of China having a place of business at 5F, No. 2 Building, No. 508 Chun Don G Road, Min Hang District, Shanghai China.

4. Legrand North America, LLC is a company duly organized and existing under the laws of Delaware. Legrand North America, LLC may be served through its registered agent The Corporation Trust Company at Corporation Trust Center, 1209 Orange Street, Wilmington, Delaware 19801.

5. The Defendants identified in paragraphs 2-4 above (collectively, “Legrand”) lead and are a part of an interrelated group of companies which together comprise one of the world’s largest manufacturers and sellers of consumer and commercial audio visual products, including under the Legrand brand.

6. The Legrand defendants named above and their affiliates are part of the same corporate structure and distribution chain for the making, importing, offering to sell, selling, and using of the accused devices in the United States, including in the State of Texas generally and this judicial district in particular.

7. The Legrand defendants named above and their affiliates share the same management, common ownership, advertising platforms, facilities, distribution chains and platforms, and accused product lines and products involving related technologies.

8. The Legrand defendants named above and their affiliates regularly contract with customers regarding equipment or services that will be provided by their affiliates on their behalf.

9. Thus, the Legrand defendants named above and their affiliates operate as a unitary business venture and are jointly and severally liable for the acts of patent infringement alleged herein.

JURISDICTION AND VENUE

10. This is an action for infringement of United States patents arising under 35 U.S.C. §§ 271, 281, and 284–85, among others. This Court has subject matter jurisdiction of the action under 28 U.S.C. § 1331 and § 1338(a).

11. This Court has personal jurisdiction over Legrand pursuant to due process and/or the Texas Long Arm Statute because, *inter alia*, (i) Legrand has done and continues to do business in Texas; and (ii) Legrand has committed and continues to commit acts of patent infringement in the State of Texas, including making, using, offering to sell, and/or selling accused products in Texas, and/or importing accused products into Texas, including by Internet sales and sales via retail and wholesale stores, inducing others to commit acts of patent infringement in Texas, and/or committing a least a portion of any other infringements alleged herein. In the alternative, Legrand SA d/b/a Legrand and Shanghai Legrand Electrical Co. Ltd. are subject to this Court’s specific personal jurisdiction consistent with the principles of due process and the Federal Long-Arm Statute of Fed. R. Civ. P. 4(k)(2) because: (1) they have substantial contacts with the United States and committed and/or induced acts of patent infringement in the United States; and (2) they are not subject to jurisdiction in any state’s courts of general jurisdiction.

12. Venue is proper as to Legrand SA d/b/a Legrand, which is organized under the laws of France. 28 U.S.C. § 1391(c)(3) provides that “a defendant not resident in the United

States may be sued in any judicial district, and the joinder of such a defendant shall be disregarded in determining where the action may be brought with respect to other defendants.”

13. Venue is proper as to Shanghai Legrand Electrical Co. Ltd., which is organized under the laws of China. 28 U.S.C. § 1391(c)(3) provides that “a defendant not resident in the United States may be sued in any judicial district, and the joinder of such a defendant shall be disregarded in determining where the action may be brought with respect to other defendants.”

14. Venue is proper in this district as to Legrand North America, LLC pursuant to 28 U.S.C. § 1400(b). Venue is further proper because Legrand North America, LLC has committed and continues to commit acts of patent infringement in this district, including making, using, offering to sell, and/or selling accused products in this district, and/or importing accused products into this district, including by Internet sales and sales via retail and wholesale stores, inducing others to commit acts of patent infringement in Texas, and/or committing at least a portion of any other infringements alleged herein in this district. Legrand North America, LLC has regular and established places of business in this district, including at least at 2000 East Wyoming Avenue, Suite C, El Paso Texas 79903, as shown on Legrand’s website:

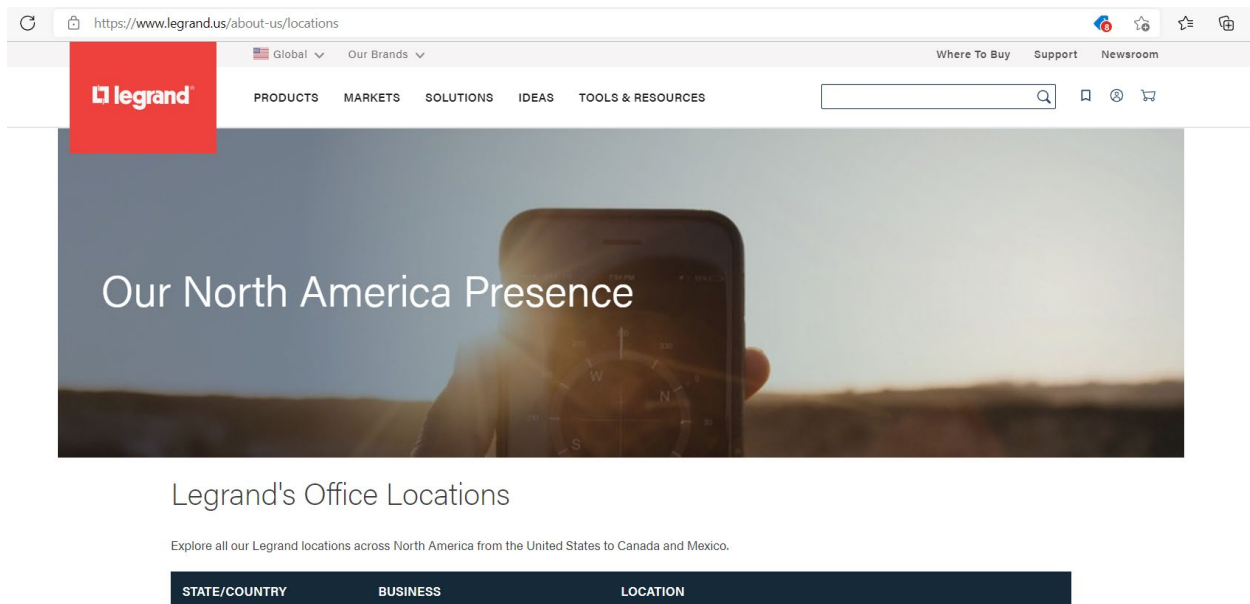

(Source: <https://legrand.us/about-us/locations>)

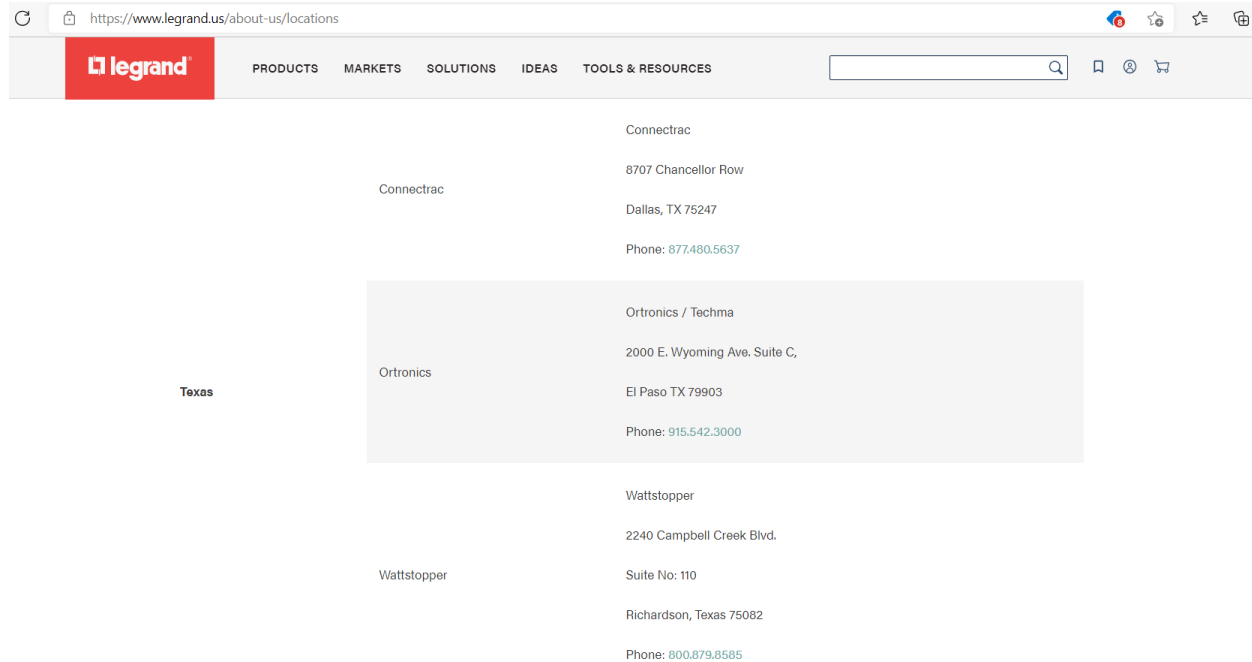

(Source: <https://legrand.us/about-us/locations>)

BACKGROUND

15. The patents-in-suit generally pertain to communications networks and other technology used in “smart” devices such as smartphones, smart TVs, and smart appliances. The technology disclosed by the patents was developed by personnel at Georgia Institute of Technology (“Georgia Tech”) and Nokia Corporation (“Nokia”).

16. Georgia Tech is a leading public research university located in Atlanta, Georgia. Founded in 1885, Georgia Tech is often ranked as one of the top ten public universities in the United States. The patents from Georgia Tech (“the Mody patents”) were developed by a professor and a graduate student in Georgia Tech’s Electrical and Computer Engineering department. The undergraduate and graduate programs of this department are often ranked in the top five of their respective categories.

17. The Mody patents are related to Multi-Input, Multi-Output (MIMO) technology. The inventors of the Mody patents were at the forefront of MIMO, developing, disclosing, and patenting a solution for achieving both time and frequency synchronization in MIMO systems. The Mody patents (or the applications leading to them) have been cited during patent prosecution hundreds of times, by numerous leading companies in the computing and communications industries, including AMD, Alcatel Lucent, Altair, AT&T, Atheros, Blackberry, Broadcom, Comcast, Ericsson, Facebook, HP, Hitachi, Huawei, Infineon, Intel, Interdigital, IBM, Kyocera, Marvell, Matsushita, Mediatek, Motorola, NEC, Nokia, Nortel Networks, NXP, Panasonic, Philips, Qualcomm, Realtek, Samsung, Sanyo, Sharp, Sony, STMicroelectronics, Texas Instruments, and Toshiba.

18. Nokia is a Finnish multinational telecommunications, IT, and consumer electronics company. Listed on both the Helsinki Stock Exchange and the New York Stock Exchange, Nokia regularly makes the Fortune Global 500. Nokia has been the largest worldwide vendor of mobile phones and smartphones and has been a major contributor to the mobile phone industry.

19. The patent developed at Nokia (“the Rauhala patent”) is related to reduction of interference in receivers with multiple antennas. The inventors of the Rauhala patent have a combined fifty plus years of experience at Nokia and were prolific inventors for Nokia. Inventor Jyri Rauhala spent over 25 years at Nokia. Mr. Rauhala obtained a Master of Science in Applied Electronics, Digital Electronics from Tampere University of Technology in Finland and is named as an inventor on 15 U.S. patents. Inventor Olli-Pekka Lunden spent over 8 years at Nokia. Dr. Lunden obtained a Doctor of Science in Technology, Radio Engineering from Aalto University and is named as an inventor on 5 U.S. patents. Currently, Dr. Lunden works as a university

lecturer at Tampere University of Technology in Finland. Inventor Marko Erkkila spent over twenty years at Nokia. Mr. Erkkila obtained a Master of Science in Digital Signal Processing, Electronics, Computer Science from Tampere University of Technology in Finland and is named as an inventor on 6 U.S. patents.

COUNT I

INFRINGEMENT OF U.S. PATENT NO. 7,088,782

20. On August 8, 2006, United States Patent No. 7,088,782 (“the ‘782 Patent”) was duly and legally issued by the United States Patent and Trademark Office for an invention entitled “Time And Frequency Synchronization In Multi-Input, Multi-Output (MIMO) Systems.”

21. American Patents is the owner of the ‘782 Patent, with all substantive rights in and to that patent, including the sole and exclusive right to prosecute this action and enforce the ‘782 Patent against infringers, and to collect damages for all relevant times.

22. Legrand used products and/or systems including, for example, its Legrand DA1104NP 802.11ac Low Profile Wireless Access Point, Legrand Luxul WS-250 Series Wireless Router Kit, and Legrand MK-10 Epic Mesh Node Kit families of products that include 802.11n and above capabilities (“accused products”):

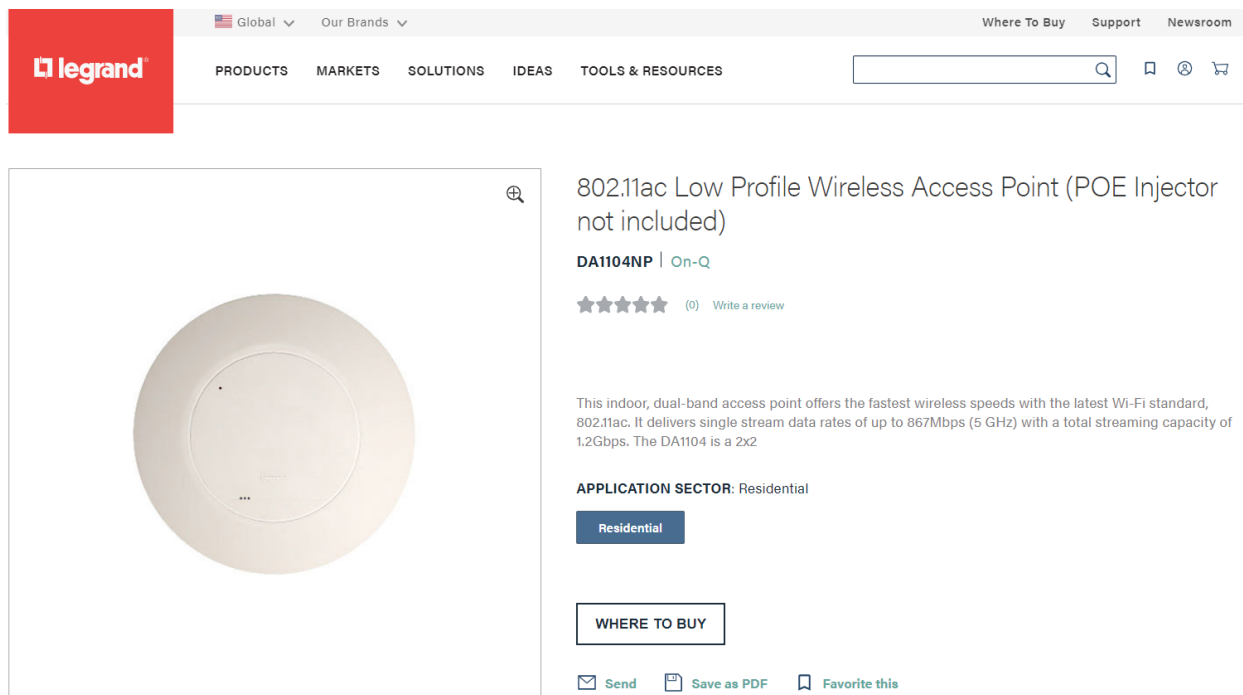

The screenshot shows the Legrand website interface. At the top left is the Legrand logo. The navigation bar includes 'Global', 'Our Brands', 'Where To Buy', 'Support', and 'Newsroom'. Below this are menu items: 'PRODUCTS', 'MARKETS', 'SOLUTIONS', 'IDEAS', and 'TOOLS & RESOURCES'. A search bar is located on the right. The main content area features a large image of a white, circular, low-profile wireless access point. To the right of the image, the product title is '802.11ac Low Profile Wireless Access Point (POE Injector not included)'. Below the title is the model number 'DA1104NP | On-Q' and a star rating system with '(0) Write a review'. A descriptive paragraph states: 'This indoor, dual-band access point offers the fastest wireless speeds with the latest Wi-Fi standard, 802.11ac. It delivers single stream data rates of up to 867Mbps (5 GHz) with a total streaming capacity of 1.2Gbps. The DA1104 is a 2x2'. Below this is the 'APPLICATION SECTOR: Residential' section with a 'Residential' button. A 'WHERE TO BUY' button is also present. At the bottom of the product information are three icons: 'Send', 'Save as PDF', and 'Favorite this'.

(Source : <https://www.legrand.us/networking/wireless-networking/legrand-wireless-access-points/80211ac-low-profile-wireless-access-point-poe-injector-not-included/p/da1104np>)



Roll over image to zoom



Wireless Router Kit - EPIC 3 AC3100 Wireless Router & Controller W/ Domotz, Router Limits and XAP-1510 AC1900 Access Point with US Power Cord

WS-250 Series | SKU: WS-250

LUXUL.



This wireless AV router kit combines high output power and simple deployment. The Luxul WS-250 offers the Epic 3 dual-band wireless AC3100 gigabit router, and the high-power AC1900 XAP-1510 access point. Including 802.11ac wireless coverage, Domotz remote AV management, family scheduling with Router Limits and roaming is solved with the built-in wireless AV controller with Roam Assist™. The WS-250 is a truly exceptional Wi-Fi experience.

The Luxul WS-250 comes with (1) Epic 3, (1) XAP-1510 and (1) PoE Injector.

Features:

- Roaming solved with Luxul Roam Assist™
- Supports up to two access points
- High power for maximum coverage
- Concurrent dual-band wireless 802.11ac
- 4x4 dual-band MIMO
- Wireless data transfers of up to 3100Mbps
- 2.4Ghz & 5GHz beamforming

(Source :

https://www.legrandav.com/products/wireless/wireless_kits/wireless_router_kit_epic_3_ac3100_domotz_router_limits_xap-1510_ac1900/ws-250#sort=relevancy&numberOfResults=20)



Roll over image to zoom

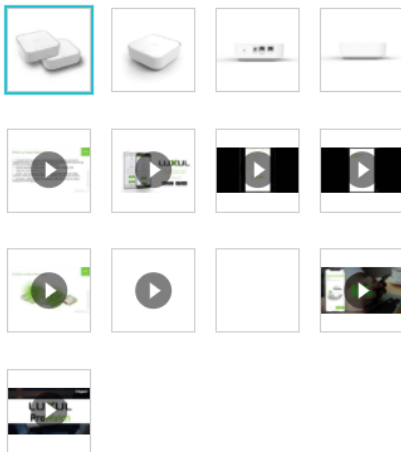

MK-10 Epic Mesh Node Kit

MK-10 Series | SKU: MK-10

LUXUL

The Wireless Mesh Kit combines the power of a Luxul wireless product with the ease of retail networking solutions. This kit can be used as a small mesh network, or as an additional/replacement nodes to extend an existing mesh network. Just plug them into an available outlet and use the Luxul Easy Setup App on your iOS or Android smartphone to define how the devices will be used: router or node. The powerful 4x4 5GHz dedicated backhaul channel ensures strong connectivity to deliver fast internet anywhere in the home.

Epic Mesh Features:

- ProWatch+ meaning you can remotely monitor and manage all connected devices on the network - from anywhere! Save time and money by using ProWatch and avoid unnecessary truck rolls
- 4x4 backhaul which allows for better communication between nodes, meaning less network congestion and faster WiFi speeds
- 8 SSIDs that can be individually named to provide you with options for setting up the network. Whether you need a separate guest network or want to keep the home automation devices apart from other network devices, you can easily do so
- Lifetime tech support
- 3-year limited warranty

This Kit Includes:

- Two (2) Epic Mesh nodes

(Source : https://www.legrandav.com/products/wireless/epic-mesh/epic_mesh_mk-10/mk-10#sort=relevancy&numberOfResults=20)

Technical Information

Data Transfer Rate	1.2 bps
Compatibility	IEEE 802.11a/b/g/n/ac- 802.3af/at Power over Ethernet
Processor	8.07
Number of Ports	32
Antenna	Dual Band: 2x2 MU-MIMO, Omni-directional

(Source : <https://www.legrand.us/networking/wireless-networking/legrand-wireless-access-points/80211ac-low-profile-wireless-access-point-poe-injector-not-included/p/dal104np>)

Specifications

Specifications for Wireless Router Kit - EPIC 3 AC3100 Wireless Router & Controller W/ Domotz, Router Limits and XAP-1510 AC1900 Access Point with US Power Cord

Dimensions & Measurements	Operating Temperature	32° to 122°F (0° to 50°C)
Characteristics & Features	Access Point Location	Indoor
	Antenna Type	<ul style="list-style-type: none"> • 4x4 MU-MIMO Wave 2 • Beamforming
	Connection Type	<ul style="list-style-type: none"> • Wired • Wireless

(Source :

https://www.legrandav.com/products/wireless/wireless_kits/wireless_router_kit_epic_3_ac3100_domotz_router_limits_xap-1510_ac1900/ws-250#sort=relevancy&numberOfResults=20)

Wireless Speed	2.4GHz - 1.0Gbps* 5GHz - 2.167Gbps*
Wireless Security	Open, WPA, WPA2, WPA/WPA2 mixed
Other Functions and Features	<ul style="list-style-type: none"> ▶ WPA encryption, DHCP, IPV6, NAT, VPN passthrough, UPnP, WAN static IP, WAN PPPoE, WAN VLAN tagging, static leases, port forwarding, DMZ, wireless guest network, band steering, client roaming, airtime fairness, adaptive path selection ▶ Backup and restore configurations ▶ Firmware upgradeable ▶ MU-MIMO with Beamforming

(Source : <https://catalog.avispl.com/SLIS/pdfs/Luxul/LUXMK10.pdf>)

23. By doing so, Legrand has directly infringed (literally and/or under the doctrine of equivalents) at least Claim 30 of the ‘782 Patent. Legrand’s infringement in this regard is ongoing.

24. Legrand has infringed the ‘782 Patent by using the accused products and thereby practicing a method for synchronizing a Multi-Input Multi-Output (MIMO) Orthogonal Frequency Division Multiplexing (OFDM) system in time and frequency domains. For example, the accused products support IEEE 802.11 n/ac standards and MIMO technology. According to the IEEE 802.11n standard, the PLCP Protocol Data Unit (PPDU) has training fields and signaling fields for helping in synchronizing the communication system.

Technical Information

Data Transfer Rate	1.2 bps
Compatibility	IEEE 802.11a/b/g/n/ac- 802.3af/at Power over Ethernet
Processor	8.07
Number of Ports	32
Antenna	Dual Band: 2x2 MU-MIMO, Omni-directional

(Source : <https://www.legrand.us/networking/wireless-networking/legrand-wireless-access-points/80211ac-low-profile-wireless-access-point-poe-injector-not-included/p/dal104np>)

Specifications

Specifications for Wireless Router Kit - EPIC 3 AC3100 Wireless Router & Controller W/ Domotz, Router Limits and XAP-1510 AC1900 Access Point with US Power Cord

Dimensions & Measurements	Operating Temperature	32° to 122°F (0° to 50°C)
Characteristics & Features	Access Point Location	Indoor
	Antenna Type	<ul style="list-style-type: none"> • 4x4 MU-MIMO Wave 2 • Beamforming
	Connection Type	<ul style="list-style-type: none"> • Wired • Wireless

(Source :

https://www.legrandav.com/products/wireless/wireless_kits/wireless_router_kit_epic_3_ac3100_domotz_router_limits_xap-1510_ac1900/ws-250#sort=relevancy&numberOfResults=20)

Wireless Speed	2.4GHz - 1.0Gbps* 5GHz - 2.167Gbps*
Wireless Security	Open, WPA, WPA2, WPA/WPA2 mixed
Other Functions and Features	<ul style="list-style-type: none"> ▶ WPA encryption, DHCP, IPV6, NAT, VPN passthrough, UPnP, WAN static IP, WAN PPPoE, WAN VLAN tagging, static leases, port forwarding, DMZ, wireless guest network, band steering, client roaming, airtime fairness, adaptive path selection ▶ Backup and restore configurations ▶ Firmware upgradeable ▶ MU-MIMO with Beamforming

(Source : <https://catalog.avispl.com/SLIS/pdfs/Luxul/LUXMK10.pdf>)

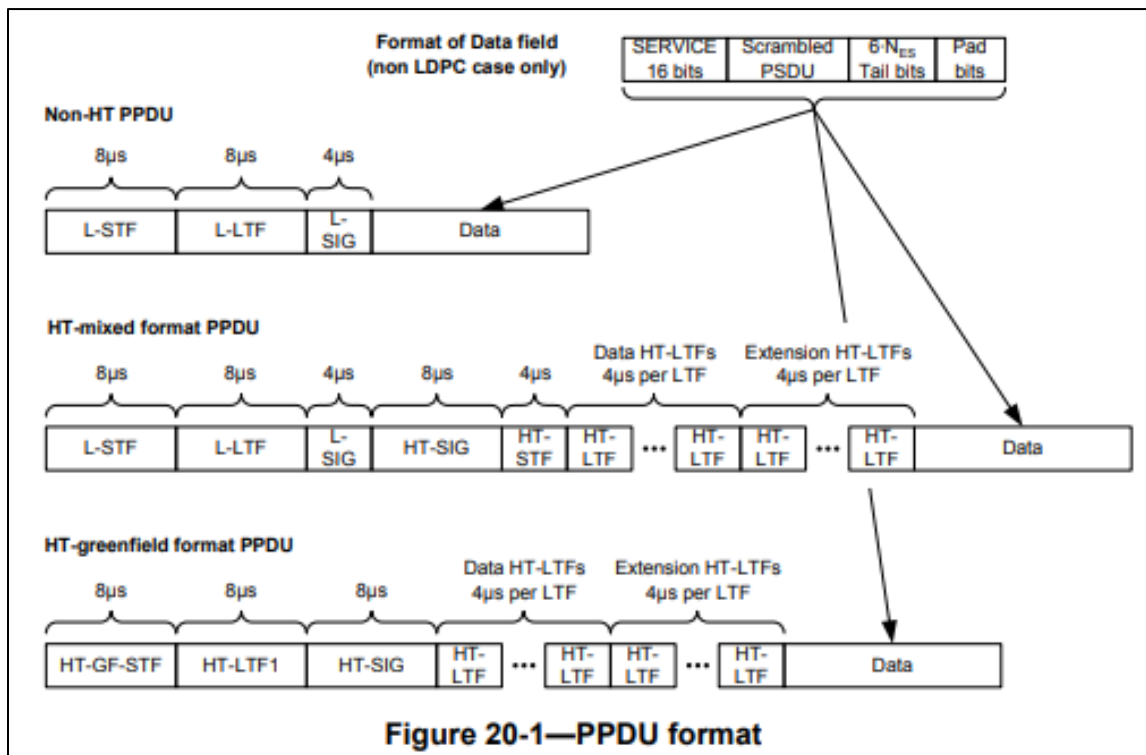

(Source: <http://luci.subsignal.org/~jow/802.11n-2009.pdf>)

Table 20-4—Elements of the HT PLCP packet

Element	Description
L-STF	Non-HT Short Training field
L-LTF	Non-HT Long Training field
L-SIG	Non-HT SIGNAL field
HT-SIG	HT SIGNAL field
HT-STF	HT Short Training field
HT-GF-STF	HT-Greenfield Short Training field
HT-LTF1	First HT Long Training field (Data)
HT-LTFs	Additional HT Long Training fields (Data and Extension)
Data	The Data field includes the PSDU

(Source: <http://luci.subsignal.org/~jow/802.11n-2009.pdf>)

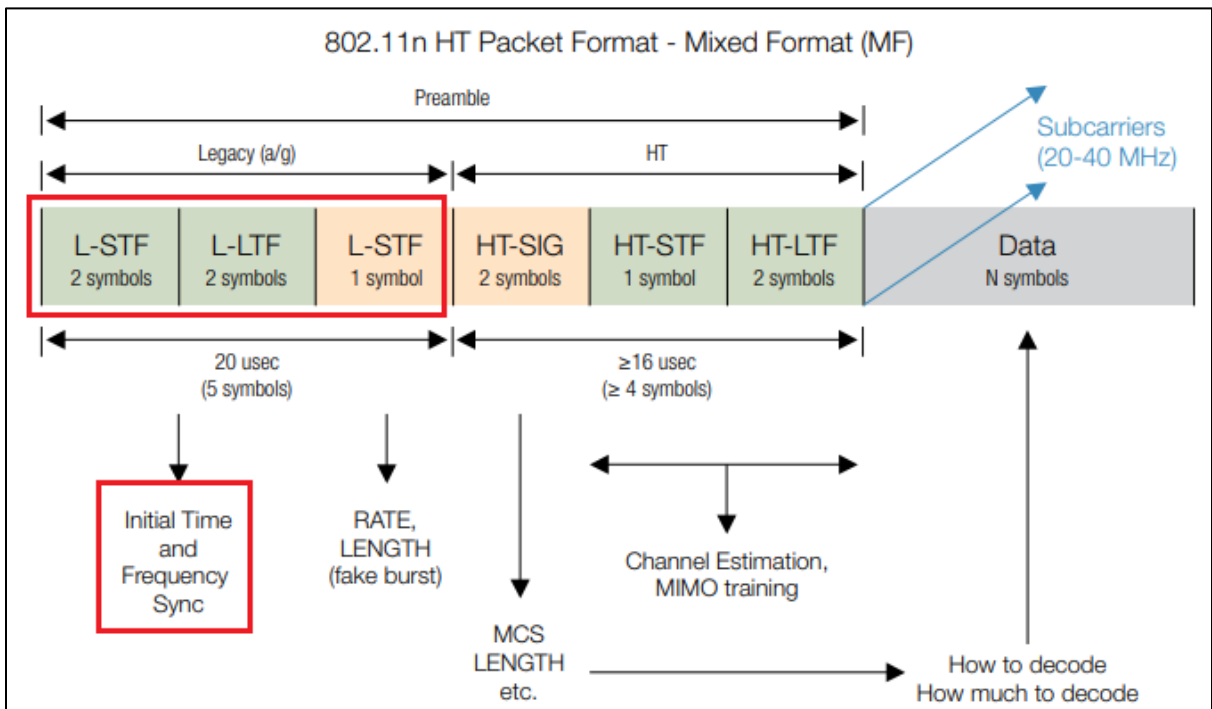

(Source: https://www.cnrood.com/en/media/solutions/Wi-Fi_Overview_of_the_802.11_Physical_Layer.pdf)

25. The methods practiced by Legrand's use of the accused products include producing a frame of data comprising a training symbol that includes a synchronization component that aids in synchronization, a plurality of data symbols, and a plurality of cyclic prefixes. For example, as part of the 802.11n standard, two preamble formats are defined for frames: HT-mixed format and HT-greenfield format. The non-HT and HT-mixed format preambles consist of training symbols, data symbols and guard intervals/cyclic prefixes, and the training symbols (L-STF and L-LTF fields) are and have been used for frame synchronization. Alternatively, on request from accused products, an 802.11 n/ac compliant WiFi access point can act as a transmitter and perform the step of producing a frame of data comprising a training symbol that includes a synchronization component that aids in synchronization, a plurality of data symbols, and a plurality of cyclic prefixes.

Two preamble formats are defined. For HT-mixed format operation, the preamble has a non-HT portion and an HT portion. The non-HT portion of the HT-mixed format preamble enables detection of the PPDU and acquisition of carrier frequency and timing by both HT STAs and STAs that are compliant with Clause 17 and/or Clause 19. The non-HT portion of the HT-mixed format preamble also consists of the SIGNAL field defined in Clause 17 and is thus decodable by STAs compliant with Clause 17 and Clause 19 as well as HT STAs.

The HT portion of the HT-mixed format preamble enables estimation of the MIMO channel to support demodulation of the HT data by HT STAs. The HT portion of the HT-mixed format preamble also includes the HT-SIG field, which supports HT operation. The SERVICE field is prepended to the PSDU.

(Source: <http://luci.subsignal.org/~jow/802.11n-2009.pdf>)

- a) Determine the number of transmit chains, N_{TX} , from the N_TX field of the TXVECTOR. Produce the PLCP preamble training fields for each of the N_{TX} transmit chains based on the FORMAT, NUM_EXTEN_SS, CH_BANDWIDTH, and MCS parameters of the TXVECTOR. The format and relative placement of the PLCP preamble training fields vary depending on the frame format being used, as indicated by these parameters. Apply cyclic shifts. Determine spatial mapping to be used for HT-STF and HT-LTFs in HT-mixed format frame and HT-GF-STF and HT-LTFs in HT-greenfield format frame from the EXPANSION_MAT parameter of the TXVECTOR. Refer to 20.3.9 for details.
- b) Construct the PLCP preamble SIGNAL fields from the appropriate fields of the TXVECTOR by adding tail bits, applying convolutional coding, formatting into one or more OFDM symbols, applying cyclic shifts, applying spatial processing, calculating an inverse Fourier transform for each OFDM symbol and transmit chain, and prepending a cyclic prefix or GI to each OFDM symbol in each transmit chain. The number and placement of the PLCP preamble SIGNAL fields depend on the frame format being used. Refer to 20.3.9.3.5, 20.3.9.4.3, and 20.3.9.5.3.
- c) Concatenate the PLCP preamble training and SIGNAL fields for each transmit chain one field after another, in the appropriate order, as described in 20.3.2 and 20.3.7.

(Source: <http://luci.subsignal.org/~jow/802.11n-2009.pdf>)

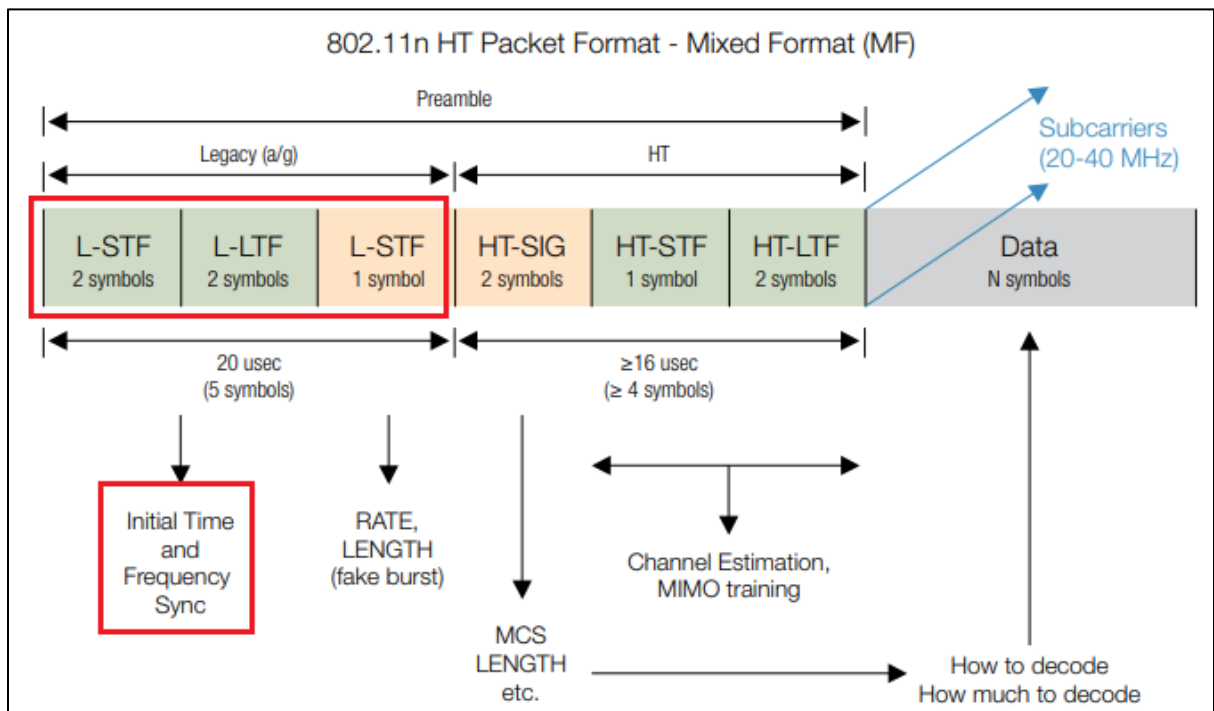

(Source: https://www.cnrood.com/en/media/solutions/Wi-Fi_Overview_of_the_802.11_Physical_Layer.pdf)

GI_TYPE	FORMAT is HT_MF or HT_GF	Indicates whether a short guard interval is used in the transmission of the packet. Enumerated type: LONG_GI indicates short GI is not used in the packet. SHORT_GI indicates short GI is used in the packet.	Y	Y
	Otherwise	Not present	N	N

(Source: <http://luci.subsignal.org/~jow/802.11n-2009.pdf>)

26. The methods practiced by Legrand's use of the accused products include transmitting the frame over a channel. The data frames containing the preambles are transmitted using one or more transmitting antennas. Alternatively, on request from an accused product, an 802.11 n/ac compliant WiFi access point can act as a transmitter and transmit the frame over a channel using one or more transmitting antennas.

<p>20.3.9 HT preamble</p> <p>20.3.9.1 Introduction</p> <p>The HT preambles are defined in HT-mixed format and in HT-greenfield format to carry the required information to operate in a system with multiple transmit and multiple receive antennas.</p> <p>In the HT-mixed format, to ensure compatibility with non-HT STAs, specific non-HT fields are defined so that they can be received by non-HT STAs compliant with Clause 17 or Clause 19 followed by the fields specific to HT STAs.</p>
--

(Source: <http://luci.subsignal.org/~jow/802.11n-2009.pdf>)

<p>20.3.10 Transmission of NON_HT format PPDU with more than one antenna</p> <p>When an HT device transmits a NON_HT format PPDU with the MODULATION parameter set to OFDM or ERP-OFDM using more than one transmit chain, it shall apply the cyclic shifts defined in Table 20-8 to the transmission in each chain.</p>

(Source: <http://luci.subsignal.org/~jow/802.11n-2009.pdf>)

27. The methods practiced by Legrand's use of the accused products include receiving the transmitted frame. For example, the receiving antennas of the accused products can receive the transmitted frames for further processing.

20.3.24 PLCP receive procedure

Typical PLCP receive procedures are shown in Figure 20-23 and Figure 20-24. The receive procedures correspond to HT-mixed format and HT-greenfield format, respectively. A typical state machine implementation of the receive PLCP is given in Figure 20-25. These receive procedures and state machine do not describe the operation of optional features, such as LDPC or STBC. If the detected format indicates a non-HT PPDU format, refer to the receive procedure and state machine in Clause 17 or Clause 19. Further, through station management (via the PLME), the PHY is set to the appropriate frequency, as specified in 20.4. Other receive parameters, such as RSSI and indicated DATARATE, may be accessed via the PHY-SAP.

(Source: <http://luci.subsignal.org/~jow/802.11n-2009.pdf>)

28. The methods practiced by Legrand's use of the accused products include demodulating the received frame. For example, the received data frames are demodulated using the PLCP preambles.

20.3 HT PLCP sublayer

20.3.1 Introduction

A convergence procedure, in which PSDUs are converted to and from PPDU, is provided for the HT PHY in 20.3. During transmission, the PSDU is processed (i.e., scrambled and coded) and appended to the PLCP preamble to create the PPDU. At the receiver, the PLCP preamble is processed to aid in demodulation and delivery of the PSDU.

(Source: <http://luci.subsignal.org/~jow/802.11n-2009.pdf>)

29. The methods practiced by Legrand's use of the accused products include synchronizing the received demodulated frame to the transmitted frame such that the data symbols are synchronized in the time domain and frequency domain. For example, different fields of data like training symbols, cyclic prefixes and other signal bits are present in the received frame. The training symbols (L-STF and L-LTF fields) help in synchronizing the frame in both the time domain and frequency domain.

Technical Information

Data Transfer Rate	1.2 bps
Compatibility	IEEE 802.11a/b/g/n/ac- 802.3af/at Power over Ethernet
Processor	8.07
Number of Ports	32
Antenna	Dual Band: 2x2 MU-MIMO, Omni-directional

(Source : <https://www.legrand.us/networking/wireless-networking/legrand-wireless-access-points/80211ac-low-profile-wireless-access-point-poe-injector-not-included/p/dal104np>)

Specifications

Specifications for Wireless Router Kit - EPIC 3 AC3100 Wireless Router & Controller W/ Domotz, Router Limits and XAP-1510 AC1900 Access Point with US Power Cord

Dimensions & Measurements	Operating Temperature	32° to 122°F (0° to 50°C)
Characteristics & Features	Access Point Location	Indoor
	Antenna Type	<ul style="list-style-type: none"> • 4x4 MU-MIMO Wave 2 • Beamforming
	Connection Type	<ul style="list-style-type: none"> • Wired • Wireless

(Source :

https://www.legrandav.com/products/wireless/wireless_kits/wireless_router_kit_epic_3_ac3100_domotz_router_limits_xap-1510_ac1900/ws-250#sort=relevancy&numberOfResults=20)

Wireless Speed	2.4GHz - 1.0Gbps* 5GHz - 2.167Gbps*
Wireless Security	Open, WPA, WPA2, WPA/WPA2 mixed
Other Functions and Features	<ul style="list-style-type: none"> ▶ WPA encryption, DHCP, IPV6, NAT, VPN passthrough, UPnP, WAN static IP, WAN PPPoE, WAN VLAN tagging, static leases, port forwarding, DMZ, wireless guest network, band steering, client roaming, airtime fairness, adaptive path selection ▶ Backup and restore configurations ▶ Firmware upgradeable ▶ MU-MIMO with Beamforming

(Source : <https://catalog.avispl.com/SLIS/pdfs/Luxul/LUXMK10.pdf>)

- a) Determine the number of transmit chains, N_{TX} , from the N_TX field of the TXVECTOR. Produce the PLCP preamble training fields for each of the N_{TX} transmit chains based on the FORMAT, NUM_EXTEN_SS, CH_BANDWIDTH, and MCS parameters of the TXVECTOR. The format and relative placement of the PLCP preamble training fields vary depending on the frame format being used, as indicated by these parameters. Apply cyclic shifts. Determine spatial mapping to be used for HT-STF and HT-LTFs in HT-mixed format frame and HT-GF-STF and HT-LTFs in HT-greenfield format frame from the EXPANSION_MAT parameter of the TXVECTOR. Refer to 20.3.9 for details.
- b) Construct the PLCP preamble SIGNAL fields from the appropriate fields of the TXVECTOR by adding tail bits, applying convolutional coding, formatting into one or more OFDM symbols, applying cyclic shifts, applying spatial processing, calculating an inverse Fourier transform for each OFDM symbol and transmit chain, and prepending a cyclic prefix or GI to each OFDM symbol in each transmit chain. The number and placement of the PLCP preamble SIGNAL fields depend on the frame format being used. Refer to 20.3.9.3.5, 20.3.9.4.3, and 20.3.9.5.3.
- c) Concatenate the PLCP preamble training and SIGNAL fields for each transmit chain one field after another, in the appropriate order, as described in 20.3.2 and 20.3.7.

(Source: <http://luci.subsignal.org/~jow/802.11n-2009.pdf>)

- a) Detect the start of frame.
- b) Detect the transition from short sequences to channel estimation sequences, and establish fine timing (with one sample resolution).
- c) Estimate the coarse and fine frequency offsets.
- d) Derotate the frame according to estimated frequency offset.
- e) Estimate the complex channel response coefficients for each of the subcarriers and each of the transmit chains.
- f) For each of the data OFDM symbols, transform the symbol into subcarrier received values, estimate the phase from the pilot subcarriers in all spatial streams, derotate the subcarrier values according to estimated phase, group the results from all the receiver chains in each subcarrier to a vector, multiply the vector by a zero-forcing equalization matrix generated from the channel estimated during the channel estimation phase.
- g) For each data-carrying subcarrier in each spatial stream, find the closest constellation point and compute the Euclidean distance from it.
- h) Compute the average of the RMS of all errors in a frame. It is given by Equation (20-89).

(Source: <http://luci.subsignal.org/~jow/802.11n-2009.pdf>)

17.3.2.1 Overview of the PPDU encoding process

The encoding process is composed of many detailed steps, which are described fully in later subclauses, as noted below. The following overview intends to facilitate understanding the details of the convergence procedure:

- a) Produce the PLCP Preamble field, composed of 10 repetitions of a “short training sequence” (used for AGC convergence, diversity selection, timing acquisition, and coarse frequency acquisition in the receiver) and two repetitions of a “long training sequence” (used for channel estimation and fine frequency acquisition in the receiver), preceded by a guard interval (GI). Refer to 17.3.3 for details.

(Source: <https://www.iith.ac.in/~tbr/teaching/docs/802.11-2007.pdf>)

30. The methods practiced by Legrand’s use of the accused products include wherein the synchronizing in the time domain comprises coarse time synchronizing and fine time synchronizing. For example, the demodulation of PPDU frames also includes detecting training field bits and establishing a timing synchronization. This time synchronization would include both coarse and fine time synchronization. In general, coarse time synchronization is done using L-STF field and fine time synchronization is done using L-LTF field present in the preamble.

- a) Detect the start of frame.
- b) Detect the transition from short sequences to channel estimation sequences, and establish fine timing (with one sample resolution).
- c) Estimate the coarse and fine frequency offsets.
- d) Derotate the frame according to estimated frequency offset.
- e) Estimate the complex channel response coefficients for each of the subcarriers and each of the transmit chains.
- f) For each of the data OFDM symbols, transform the symbol into subcarrier received values, estimate the phase from the pilot subcarriers in all spatial streams, derotate the subcarrier values according to estimated phase, group the results from all the receiver chains in each subcarrier to a vector, multiply the vector by a zero-forcing equalization matrix generated from the channel estimated during the channel estimation phase.
- g) For each data-carrying subcarrier in each spatial stream, find the closest constellation point and compute the Euclidean distance from it.
- h) Compute the average of the RMS of all errors in a frame. It is given by Equation (20-89).

(Source: <http://luci.subsignal.org/~jow/802.11n-2009.pdf>)

The simplest packet is the one used when operating in the legacy mode, which has the same format as the packets used in 802.11a/g. The L-STF field, which stands for the *legacy-short training field*, consists of two augmented OFDM symbols of 4 μ s duration each, and these are used by the receiver to perform time and frequency synchronization and to adjust its AGC. After the two L-STF augmented OFDM symbols, there is a second field called L-LTF, which stands for *legacy-long training field*, which is used to perform fine timing adjustments after the initial coarse acquisition in the L-STF field. The third field, called L-SIG, which stands for *legacy signal field*, contains data that tell the receiver what modulation and coding will be used in the data portion of the packet. The L-SIG field consists of one augmented OFDM symbol.

(Source: Introduction to MIMO Communications, Hampton, Jerry R. (2014))

Receive procedure

Typically, the receiver waits for a signal to exceed a threshold before initiating the packet reception procedure. The minimum requirement in 802.11a is to detect the start of a valid transmission received at a power level of at least -82 dBm within $4 \mu\text{s}$ with a probability greater than 90%. Due to competitive pressures, most products exceed this specification by 5–10 dB.

The short training symbols are processed to set the AGC, initial frequency correction, and initial timing acquisition. This is followed by processing the long training symbols for fine frequency correction and fine timing adjustment. The LTF is also used to generate the channel estimate.

(Source: Next Generation Wireless LANs: 802.11n and 802.11ac, Perahia, Eldad and Stacey, Robert)

31. Legrand has had actual knowledge of the ‘782 Patent at least as of the date when it was notified of the filing of this action. By the time of trial, Legrand will have known and intended (since receiving such notice) that its continued actions would infringe and actively induce and contribute to the infringement of one or more claims of the ‘782 Patent.

32. Legrand has also indirectly and willfully infringed, and continues to indirectly and willfully infringe, the ‘782 Patent, as explained further below in the “Additional Allegations Regarding Infringement” section.

33. American Patents has been damaged as a result of the infringing conduct by Legrand alleged above. Thus, Legrand is liable to American Patents in an amount that adequately compensates it for such infringements, which, by law, cannot be less than a reasonable royalty, together with interest and costs as fixed by this Court under 35 U.S.C. § 284.

34. American Patents has neither made nor sold unmarked articles that practice the ‘782 Patent, and is entitled to collect pre-filing damages for the full period allowed by law for infringement of the ‘782 Patent.

COUNT II

INFRINGEMENT OF U.S. PATENT NO. 7,310,304

35. On December 18, 2007, United States Patent No. 7,310,304 (“the ‘304 Patent”) was duly and legally issued by the United States Patent and Trademark Office for an invention entitled “Estimating Channel Parameters in Multi-Input, Multi-Output (MIMO) Systems.”

36. American Patents is the owner of the ‘304 Patent, with all substantive rights in and to that patent, including the sole and exclusive right to prosecute this action and enforce the ‘304 Patent against infringers, and to collect damages for all relevant times.

37. Legrand made, had made, used, imported, provided, supplied, distributed, sold, and/or offered for sale products and/or systems including, for example, its Legrand DA1104NP 802.11ac Low Profile Wireless Access Point, Legrand Luxul WS-250 Series Wireless Router Kit, and Legrand MK-10 Epic Mesh Node Kit families of products that include 802.11n and above capabilities (“accused products”):

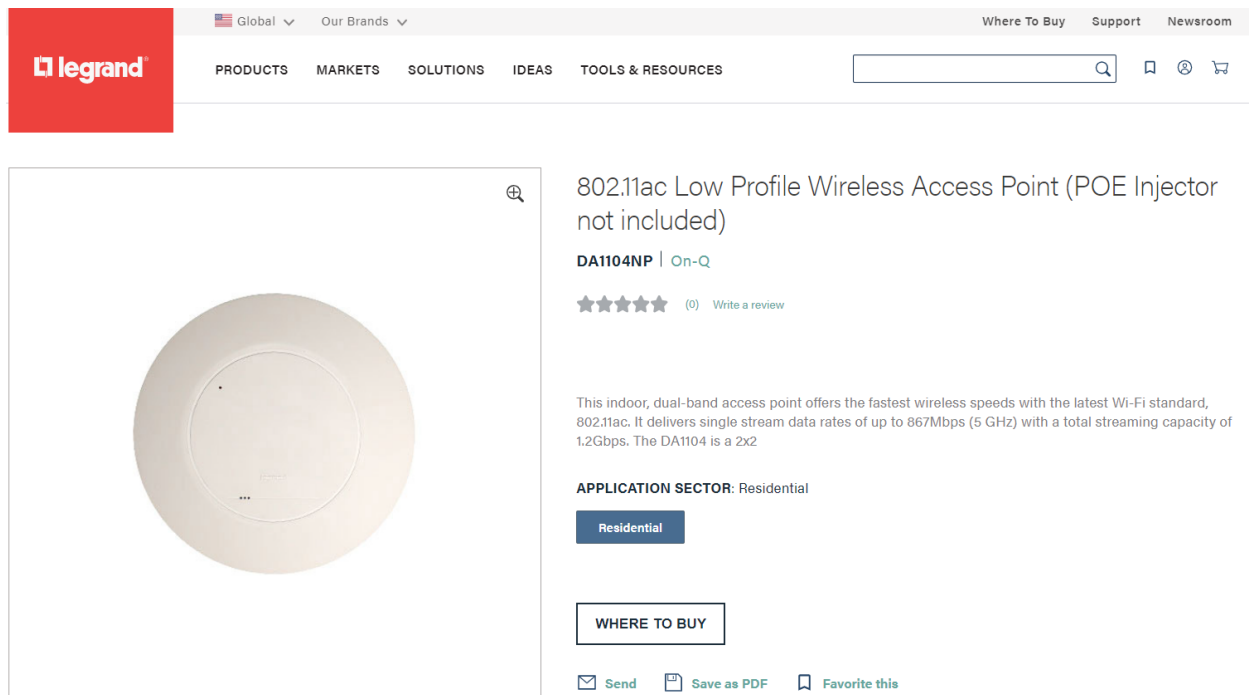

The screenshot shows the Legrand website's product page for the DA1104NP 802.11ac Low Profile Wireless Access Point. The page features a navigation bar with the Legrand logo, a search bar, and links for 'Global', 'Our Brands', 'Where To Buy', 'Support', and 'Newsroom'. The main content area includes a large image of the access point, a product title, a model number (DA1104NP), a star rating, a description of the product's capabilities, an application sector (Residential), a 'WHERE TO BUY' button, and social sharing options (Send, Save as PDF, Favorite this).

Global | Our Brands | Where To Buy | Support | Newsroom

legrand | PRODUCTS | MARKETS | SOLUTIONS | IDEAS | TOOLS & RESOURCES

802.11ac Low Profile Wireless Access Point (POE Injector not included)

DA1104NP | On-Q

★★★★★ (0) Write a review

This indoor, dual-band access point offers the fastest wireless speeds with the latest Wi-Fi standard, 802.11ac. It delivers single stream data rates of up to 867Mbps (5 GHz) with a total streaming capacity of 1.2Gbps. The DA1104 is a 2x2

APPLICATION SECTOR: Residential

Residential

WHERE TO BUY

Send | Save as PDF | Favorite this

(Source : <https://www.legrand.us/networking/wireless-networking/legrand-wireless-access-points/80211ac-low-profile-wireless-access-point-poe-injector-not-included/p/da1104np>)



Roll over image to zoom



Wireless Router Kit - EPIC 3 AC3100 Wireless Router & Controller W/ Domotz, Router Limits and XAP-1510 AC1900 Access Point with US Power Cord

WS-250 Series | SKU: WS-250

LUXUL.



This wireless AV router kit combines high output power and simple deployment. The Luxul WS-250 offers the Epic 3 dual-band wireless AC3100 gigabit router, and the high-power AC1900 XAP-1510 access point. Including 802.11ac wireless coverage, Domotz remote AV management, family scheduling with Router Limits and roaming is solved with the built-in wireless AV controller with Roam Assist™. The WS-250 is a truly exceptional Wi-Fi experience.

The Luxul WS-250 comes with (1) Epic 3, (1) XAP-1510 and (1) PoE Injector.

Features:

- Roaming solved with Luxul Roam Assist™
- Supports up to two access points
- High power for maximum coverage
- Concurrent dual-band wireless 802.11ac
- 4x4 dual-band MIMO
- Wireless data transfers of up to 3100Mbps
- 2.4Ghz & 5GHz beamforming

(Source :

https://www.legrandav.com/products/wireless/wireless_kits/wireless_router_kit_epic_3_ac3100_domotz_router_limits_xap-1510_ac1900/ws-250#sort=relevancy&numberOfResults=20)



Roll over image to zoom

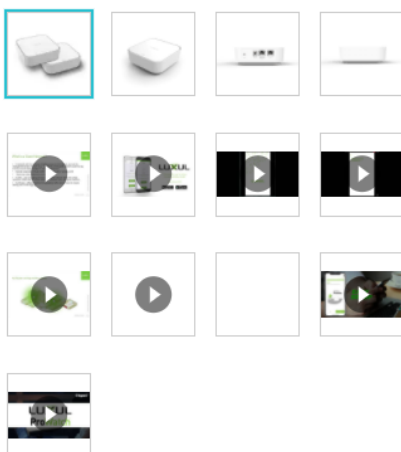

MK-10 Epic Mesh Node Kit

MK-10 Series | SKU: MK-10

LUXUL

The Wireless Mesh Kit combines the power of a Luxul wireless product with the ease of retail networking solutions. This kit can be used as a small mesh network, or as an additional/replacement nodes to extend an existing mesh network. Just plug them into an available outlet and use the Luxul Easy Setup App on your iOS or Android smartphone to define how the devices will be used: router or node. The powerful 4x4 5GHz dedicated backhaul channel ensures strong connectivity to deliver fast internet anywhere in the home.

Epic Mesh Features:

- ProWatch+ meaning you can remotely monitor and manage all connected devices on the network - from anywhere! Save time and money by using ProWatch and avoid unnecessary truck rolls
- 4x4 backhaul which allows for better communication between nodes, meaning less network congestion and faster WiFi speeds
- 8 SSIDs that can be individually named to provide you with options for setting up the network. Whether you need a separate guest network or want to keep the home automation devices apart from other network devices, you can easily do so
- Lifetime tech support
- 3-year limited warranty

This Kit Includes:

- Two (2) Epic Mesh nodes

(Source : https://www.legrandav.com/products/wireless/epic-mesh/epic_mesh_mk-10/mk-10#sort=relevancy&numberOfResults=20)

Technical Information

Data Transfer Rate	1.2 bps
Compatibility	IEEE 802.11a/b/g/n/ac- 802.3af/at Power over Ethernet
Processor	8.07
Number of Ports	32
Antenna	Dual Band: 2x2 MU-MIMO, Omni-directional

(Source : <https://www.legrand.us/networking/wireless-networking/legrand-wireless-access-points/80211ac-low-profile-wireless-access-point-poe-injector-not-included/p/dal104np>)

Specifications

Specifications for Wireless Router Kit - EPIC 3 AC3100 Wireless Router & Controller W/ Domotz, Router Limits and XAP-1510 AC1900 Access Point with US Power Cord

Dimensions & Measurements	Operating Temperature	32° to 122°F (0° to 50°C)
Characteristics & Features	Access Point Location	Indoor
	Antenna Type	<ul style="list-style-type: none"> • 4x4 MU-MIMO Wave 2 • Beamforming
	Connection Type	<ul style="list-style-type: none"> • Wired • Wireless

(Source :

https://www.legrandav.com/products/wireless/wireless_kits/wireless_router_kit_epic_3_ac3100_domotz_router_limits_xap-1510_ac1900/ws-250#sort=relevancy&numberOfResults=20)

Wireless Speed	2.4GHz - 1.0Gbps* 5GHz - 2.167Gbps*
Wireless Security	Open, WPA, WPA2, WPA/WPA2 mixed
Other Functions and Features	<ul style="list-style-type: none"> ▶ WPA encryption, DHCP, IPV6, NAT, VPN passthrough, UPnP, WAN static IP, WAN PPPoE, WAN VLAN tagging, static leases, port forwarding, DMZ, wireless guest network, band steering, client roaming, airtime fairness, adaptive path selection ▶ Backup and restore configurations ▶ Firmware upgradeable ▶ MU-MIMO with Beamforming

(Source : <https://catalog.avispl.com/SLIS/pdfs/Luxul/LUXMK10.pdf>)

38. By doing so, Legrand has directly infringed (literally and/or under the doctrine of equivalents) at least Claim 1 of the ‘304 Patent. Legrand’s infringement in this regard is ongoing.

39. Legrand has infringed the ‘304 Patent by making, having made, using, importing, providing, supplying, distributing, selling or offering for sale products including an Orthogonal Frequency Division Multiplexing (OFDM) transmitter. For example, the accused products support IEEE 802.11 n/ac standards and MIMO technology. The IEEE 802.11n standard “uses OFDM modulation to transmit all data.”

The 802.11n-2009 wireless LAN standard provides Higher Throughput (HT) rates. These higher rates are achieved by a combination of MAC and PHY layer enhancements. The enhancements include:

- Reducing the per-packet overhead in the MAC layer.
- Allowing multiple MAC packets to be combined into a single PHY-layer burst.
- Allowing (optionally) a more efficient LDPC encoder.
- Allowing (optionally) a shorter guard interval (cyclic prefix) on the data symbols.
- Increasing the number of subcarriers used in the default 20 MHz physical channel.
- Providing an (optional) 40 MHz mode.
- Using MIMO techniques to broadcast multiple data streams over a single frequency channel.

By combining these techniques, the goal is to increase the usable data transfer rate by a factor of 10.

Signal Characteristics

The 802.11n standard uses OFDM modulation to transmit all data. It defines three operating modes:

(Source:

http://rfmw.em.keysight.com/wireless/helpfiles/89600b/webhelp/subsystems/wlan-mimo/Content/mimo_80211n_overview.htm)

40. The accused products include an encoder configured to process data to be transmitted within an OFDM system, the encoder further configured to separate the data onto one or more transmit diversity branches (TDBs). For example, the 802.11 ac standard is backwards compatible with 802.11n and 802.11a. Thus, if a device, such as an accused product, implements 802.11ac, then it also supports 802.11n and all previous versions of the WiFi standards (i.e., IEEE 802.11 a/b/g/n). According to the IEEE 802.11n standard, an encoder block is present in a transmitter section of general OFDM systems. The encoder(s) output(s) the data onto multiple transmit chains (transmit diversity branches) for further processing.

The introduction of 802.11ac expands the compatibility matrix in the 5 GHz band from two concurrently operating technologies to three, and the compatibility considerations in a broadcast network medium extend not only to intended receivers but to any receiver. Table 3-4 describes the compatibility between transmitters of frames and their intended receivers. That is, if a transmitter of the type in the left column sends a frame directed to a receiver of the type in any of the other three columns, what will the result be? One of the major methods used to support coexistence is backward compatibility. When built, 802.11ac devices will also incorporate 802.11a and 802.11n data rates, and thus will be able to send to older peers at older data rates.

(Source: 802.11ac: A Survival Guide: Wi-Fi at Gigabit and Beyond, Gast, Matthew S.)

Table 3-5. Compatibility between transmitters and listening devices

Transmitter type	802.11a listener	802.11n listener	802.11ac listener
802.11a	Designed operation	802.11n devices listen to 802.11a frames and defer medium access to avoid collisions	802.11ac devices listen to 802.11a frames and defer medium access to avoid collisions
802.11n	802.11n greenfield frames require RTS/CTS or CTS-to-self protection; 802.11n mixed-mode frames require no special protection	Designed operation	802.11ac devices listen to 802.11n frames and defer medium access to avoid collisions
802.11ac	802.11ac uses a compatible physical preamble, allowing 802.11a devices to read the medium as busy and avoid collisions	802.11ac uses a compatible preamble, allowing 802.11n devices to read the medium as busy and avoid collisions	Designed operation

(Source: 802.11ac: A Survival Guide: Wi-Fi at Gigabit and Beyond, Gast, Matthew S.)

20.3.3 Transmitter block diagram

HT-mixed format and HT-greenfield format transmissions can be generated using a transmitter consisting of the following blocks:

- a) *Scrambler* scrambles the data to reduce the probability of long sequences of zeros or ones; see 20.3.11.2.
- b) *Encoder parser*, if BCC encoding is to be used, demultiplexes the scrambled bits among N_{ES} (number of BCC encoders for the Data field) BCC encoders, in a round robin manner.
- c) *FEC encoders* encode the data to enable error correction. An FEC encoder may include a binary convolutional encoder followed by a puncturing device, or it may include an LDPC encoder.
- d) *Stream parser* divides the outputs of the encoders into blocks that are sent to different interleaver and mapping devices. The sequence of the bits sent to an interleaver is called a *spatial stream*.
- e) *Interleaver* interleaves the bits of each spatial stream (changes order of bits) to prevent long sequences of adjacent noisy bits from entering the BCC decoder. Interleaving is applied only when BCC encoding is used.
- f) *Constellation mapper* maps the sequence of bits in each spatial stream to constellation points (complex numbers).
- g) *STBC* encoder spreads constellation points from N_{SS} spatial streams into N_{STS} space-time streams using a space-time block code. STBC is used only when $N_{SS} < N_{STS}$; see 20.3.11.8.1.
- h) *Spatial mapper* maps space-time streams to transmit chains. This may include one of the following:
 - 1) *Direct mapping*: Constellation points from each space-time stream are mapped directly onto the transmit chains (one-to-one mapping).

(Source: <http://luci.subsignal.org/~jow/802.11n-2009.pdf>)

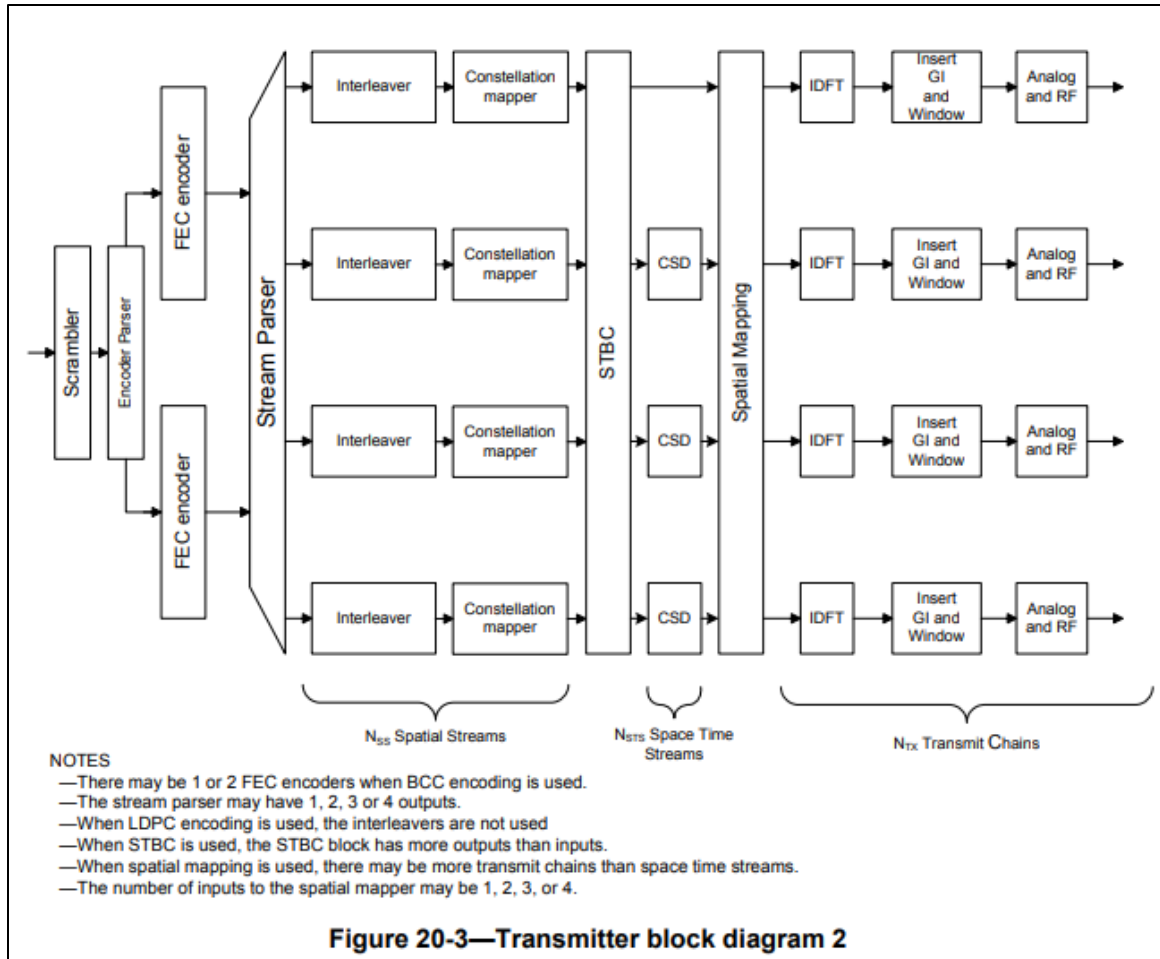

(Source: <http://luci.subsignal.org/~jow/802.11n-2009.pdf>)

41. The accused products include one or more OFDM modulators, each OFDM modulator connected to a respective TDB, each OFDM modulator configured to produce a frame including a plurality of data symbols, a training structure, and cyclic prefixes inserted among the data symbols. For example, according to the IEEE 802.11n standard, a transmitter block would contain different functional blocks which include constellation mappers, IDFT stage, and Guard interval insertion. The constellation mapper maps the bits and the constellation points for different modulation schemes like QPSK, BPSK, 16-QAM, and 64-QAM. Hence, there would be modulator blocks for performing the modulation. After modulating the signal, it is converted

into the time domain and is transmitted as frames of data. These transmitted frames include a training structure, signal bits, cyclic prefixes and data bits.

20.3.3 Transmitter block diagram

HT-mixed format and HT-greenfield format transmissions can be generated using a transmitter consisting of the following blocks:

- a) *Scrambler* scrambles the data to reduce the probability of long sequences of zeros or ones; see 20.3.11.2.
- b) *Encoder parser*, if BCC encoding is to be used, demultiplexes the scrambled bits among N_{ES} (number of BCC encoders for the Data field) BCC encoders, in a round robin manner.
- c) *FEC encoders* encode the data to enable error correction. An FEC encoder may include a binary convolutional encoder followed by a puncturing device, or it may include an LDPC encoder.
- d) *Stream parser* divides the outputs of the encoders into blocks that are sent to different interleaver and mapping devices. The sequence of the bits sent to an interleaver is called a *spatial stream*.
- e) *Interleaver* interleaves the bits of each spatial stream (changes order of bits) to prevent long sequences of adjacent noisy bits from entering the BCC decoder. Interleaving is applied only when BCC encoding is used.
- f) *Constellation mapper* maps the sequence of bits in each spatial stream to constellation points (complex numbers).
- g) *STBC encoder* spreads constellation points from N_{SS} spatial streams into N_{STS} space-time streams using a space-time block code. STBC is used only when $N_{SS} < N_{STS}$; see 20.3.11.8.1.
- h) *Spatial mapper* maps space-time streams to transmit chains. This may include one of the following:
 - 1) *Direct mapping*: Constellation points from each space-time stream are mapped directly onto the transmit chains (one-to-one mapping).

(Source: <http://luci.subsignal.org/~jow/802.11n-2009.pdf>)

The encoding process is composed of the steps described below. The following overview is intended to facilitate an understanding of the details of the convergence procedure:

- a) Determine the number of transmit chains, N_{TX} , from the N_TX field of the TXVECTOR. Produce the PLCP preamble training fields for each of the N_{TX} transmit chains based on the FORMAT, NUM_EXTEN_SS, CH_BANDWIDTH, and MCS parameters of the TXVECTOR. The format and relative placement of the PLCP preamble training fields vary depending on the frame format being used, as indicated by these parameters. Apply cyclic shifts. Determine spatial mapping to be used for HT-STF and HT-LTFs in HT-mixed format frame and HT-GF-STF and HT-LTFs in HT-greenfield format frame from the EXPANSION_MAT parameter of the TXVECTOR. Refer to 20.3.9 for details.
- b) Construct the PLCP preamble SIGNAL fields from the appropriate fields of the TXVECTOR by adding tail bits, applying convolutional coding, formatting into one or more OFDM symbols, applying cyclic shifts, applying spatial processing, calculating an inverse Fourier transform for each OFDM symbol and transmit chain, and prepending a cyclic prefix or GI to each OFDM symbol in each transmit chain. The number and placement of the PLCP preamble SIGNAL fields depend on the frame format being used. Refer to 20.3.9.3.5, 20.3.9.4.3, and 20.3.9.5.3.
- c) Concatenate the PLCP preamble training and SIGNAL fields for each transmit chain one field after another, in the appropriate order, as described in 20.3.2 and 20.3.7.

(Source: <http://luci.subsignal.org/~jow/802.11n-2009.pdf>)

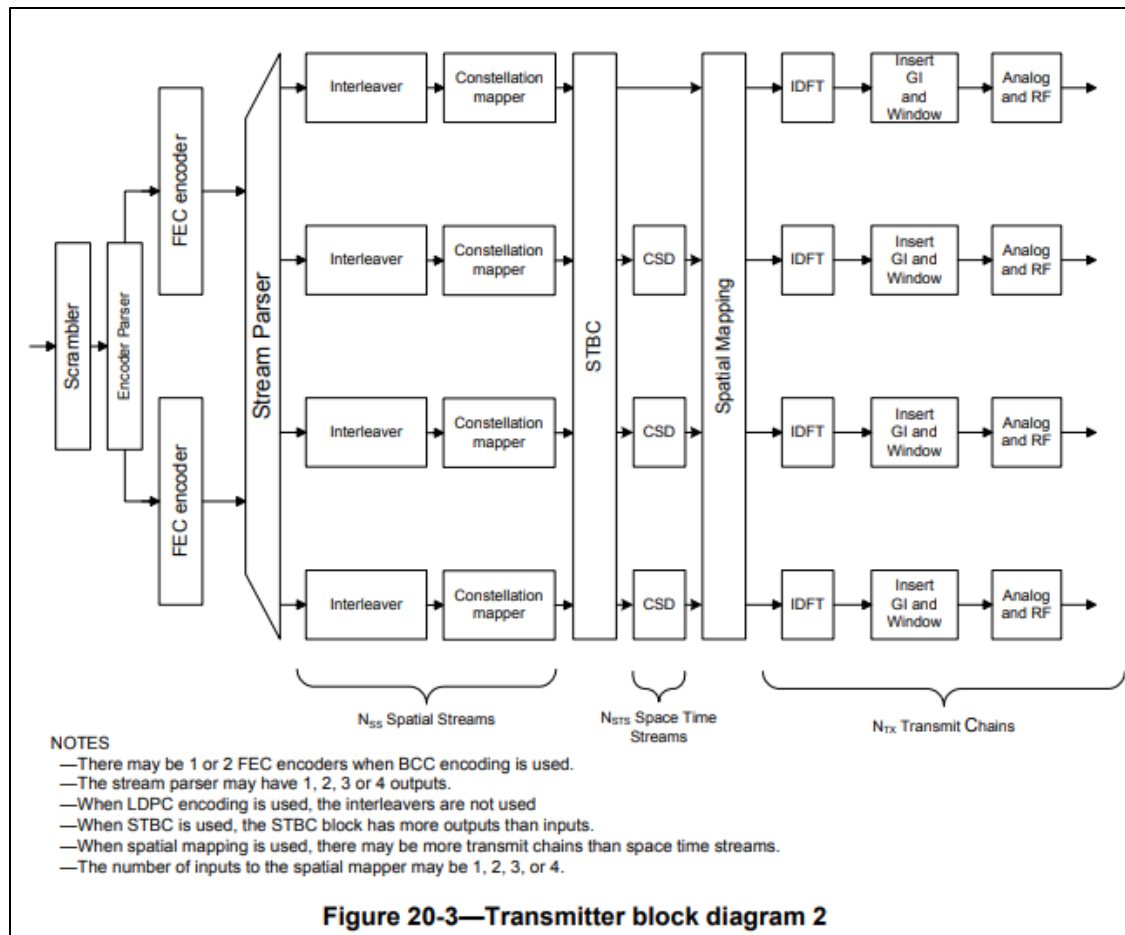

(Source: <http://luci.subsignal.org/~jow/802.11n-2009.pdf>)

42. The accused products include one or more transmitting antennas in communication with the one or more OFDM modulators, respectively, each transmitting antenna configured to transmit the respective frame over a channel. The accused products support 802.11 a/b/g/n/ac WiFi standards and comprise one or more transmitting and one or more receiving antennas. These transmitting antennas transmit multiple OFDM frames with various signal fields over a channel. Thus, these transmitting antennas are connected to the OFDM modulators to obtain the OFDM frames for further transmission.

Technical Information

Data Transfer Rate	1.2 bps
Compatibility	IEEE 802.11a/b/g/n/ac- 802.3af/at Power over Ethernet
Processor	8.07
Number of Ports	32
Antenna	Dual Band: 2x2 MU-MIMO, Omni-directional

(Source : <https://www.legrand.us/networking/wireless-networking/legrand-wireless-access-points/80211ac-low-profile-wireless-access-point-poe-injector-not-included/p/dal104np>)

Specifications

Specifications for Wireless Router Kit - EPIC 3 AC3100 Wireless Router & Controller W/ Domotz, Router Limits and XAP-1510 AC1900 Access Point with US Power Cord

Dimensions & Measurements	Operating Temperature	32° to 122°F (0° to 50°C)
Characteristics & Features	Access Point Location	Indoor
	Antenna Type	<ul style="list-style-type: none"> • 4x4 MU-MIMO Wave 2 • Beamforming
	Connection Type	<ul style="list-style-type: none"> • Wired • Wireless

(Source :

https://www.legrandav.com/products/wireless/wireless_kits/wireless_router_kit_epic_3_ac3100_domotz_router_limits_xap-1510_ac1900/ws-250#sort=relevancy&numberOfResults=20)

Wireless Speed	2.4GHz - 1.0Gbps* 5GHz - 2.167Gbps*
Wireless Security	Open, WPA, WPA2, WPA/WPA2 mixed
Other Functions and Features	<ul style="list-style-type: none"> ▶ WPA encryption, DHCP, IPV6, NAT, VPN passthrough, UPnP, WAN static IP, WAN PPPoE, WAN VLAN tagging, static leases, port forwarding, DMZ, wireless guest network, band steering, client roaming, airtime fairness, adaptive path selection ▶ Backup and restore configurations ▶ Firmware upgradeable ▶ MU-MIMO with Beamforming

(Source : <https://catalog.avispl.com/SLIS/pdfs/Luxul/LUXMK10.pdf>)

The 802.11n-2009 wireless LAN standard provides Higher Throughput (HT) rates. These higher rates are achieved by a combination of MAC and PHY layer enhancements. The enhancements include:

- Reducing the per-packet overhead in the MAC layer.
- Allowing multiple MAC packets to be combined into a single PHY-layer burst.
- Allowing (optionally) a more efficient LDPC encoder.
- Allowing (optionally) a shorter guard interval (cyclic prefix) on the data symbols.
- Increasing the number of subcarriers used in the default 20 MHz physical channel.
- Providing an (optional) 40 MHz mode.
- Using MIMO techniques to broadcast multiple data streams over a single frequency channel.

By combining these techniques, the goal is to increase the usable data transfer rate by a factor of 10.

Signal Characteristics

The 802.11n standard uses OFDM modulation to transmit all data. It defines three operating modes:

(Source: http://rfmw.em.keysight.com/wireless/helpfiles/89600b/webhelp/subsystems/wlan-mimo/Content/mimo_80211n_overview.htm)

20.3.4 Overview of the PPDU encoding process

The encoding process is composed of the steps described below. The following overview is intended to facilitate an understanding of the details of the convergence procedure:

- a) Determine the number of transmit chains, N_{TX} , from the N_TX field of the TXVECTOR. Produce the PLCP preamble training fields for each of the N_{TX} transmit chains based on the FORMAT, NUM_EXTEN_SS, CH_BANDWIDTH, and MCS parameters of the TXVECTOR. The format and relative placement of the PLCP preamble training fields vary depending on the frame format being used, as indicated by these parameters. Apply cyclic shifts. Determine spatial mapping to be used for HT-STF and HT-LTFs in HT-mixed format frame and HT-GF-STF and HT-LTFs in HT-greenfield format frame from the EXPANSION_MAT parameter of the TXVECTOR. Refer to 20.3.9 for details.
- b) Construct the PLCP preamble SIGNAL fields from the appropriate fields of the TXVECTOR by adding tail bits, applying convolutional coding, formatting into one or more OFDM symbols, applying cyclic shifts, applying spatial processing, calculating an inverse Fourier transform for each OFDM symbol and transmit chain, and prepending a cyclic prefix or GI to each OFDM symbol in each transmit chain. The number and placement of the PLCP preamble SIGNAL fields depend on the frame format being used. Refer to 20.3.9.3.5, 20.3.9.4.3, and 20.3.9.5.3.
- c) Concatenate the PLCP preamble training and SIGNAL fields for each transmit chain one field after another, in the appropriate order, as described in 20.3.2 and 20.3.7.

(Source: <http://luci.subsignal.org/~jow/802.11n-2009.pdf>)

43. The accused products include wherein the training structure of each frame includes a predetermined signal transmission matrix at a respective sub-channel, each training structure adjusted to have a substantially constant amplitude in a time domain, and the cyclic prefixes are further inserted within the training symbol, and wherein the cyclic prefixes within the training symbol are longer than the cyclic prefixes among the data symbols, thereby countering an extended channel impulse response and improving synchronization performance. For example, a space time matrix is part of the data symbols and the training symbols in the transmission data. This data is transmitted over different antennas. The WiFi standards use guard intervals while transmitting frames to help the synchronization of frames at the receiver end. These guard intervals are of different lengths for the preamble and data symbols. The screenshots below show the Guard interval in the Long Training Field is 1.6 micro seconds, and

the data field uses a Short guard interval of 0.4 micro seconds, so the cyclic prefix for the training symbols is longer than the cyclic prefix for data symbols. The training symbols (L-STF, HT-STF fields) in the 802.11n preamble have a constant amplitude in the time domain.

p)	Map each of the complex numbers in each of the N_{ST} subcarriers in each of the OFDM symbols in each of the N_{STS} space-time streams to the N_{TX} transmit chain inputs. For direct-mapped operation, $N_{TX} = N_{STS}$, and there is a one-to-one correspondence between space-time streams and transmit chains. In this case, the OFDM symbols associated with each space-time stream are also associated with the corresponding transmit chain. Otherwise, a spatial mapping matrix associated with each OFDM subcarrier, as indicated by the EXPANSION_MAT parameter of the TXVECTOR, is used to perform a linear transformation on the vector of N_{STS} complex numbers associated with each subcarrier in each OFDM symbol. This spatial mapping matrix maps the vector of N_{STS} complex numbers in each subcarrier into a vector of N_{TX} complex numbers in each subcarrier. The sequence of N_{ST} complex numbers associated with each transmit chain (where each of the N_{ST} complex numbers is taken from the same position in the N_{TX} vector of complex numbers across the N_{ST} subcarriers associated with an OFDM symbol) constitutes an OFDM symbol associated with the corresponding transmit chain. For details, see 20.3.11.10. Spatial mapping matrices may include cyclic shifts, as described in 20.3.11.10.1.
----	---

(Source: <http://luci.subsignal.org/~jow/802.11n-2009.pdf>)

T_{DFT} : IDFT/DFT period	3.2 μ s	3.2 μ s	3.2 μ s
T_{GI} : Guard interval duration	0.8 μ s = $T_{DFT}/4$	0.8 μ s	0.8 μ s
T_{GI2} : Double guard interval	1.6 μ s	1.6 μ s	1.6 μ s
T_{GIS} : Short guard interval duration	N/A	0.4 μ s = $T_{DFT}/8$	0.4 μ s See NOTE 2
T_{L-STF} : Non-HT short training sequence duration	8 μ s = $10 \times T_{DFT}/4$	8 μ s	8 μ s
$T_{HT-GF-STF}$: HT-greenfield short training field duration	N/A	8 μ s = $10 \times T_{DFT}/4$	8 μ s See NOTE 2
T_{L-LTF} : Non-HT long training field duration	8 μ s = $2 \times T_{DFT} + T_{GI2}$	8 μ s	8 μ s
T_{SYM} : Symbol interval	4 μ s = $T_{DFT} + T_{GI}$	4 μ s	4 μ s
T_{SYMS} : Short GI symbol interval	N/A	3.6 μ s = $T_{DFT} + T_{GIS}$	3.6 μ s See NOTE 2

(Source: <http://luci.subsignal.org/~jow/802.11n-2009.pdf>)

STBC	2	Set to a nonzero number, to indicate the difference between the number of space-time streams (N_{STS}) and the number of spatial streams (N_{SS}) indicated by the MCS. Set to 00 to indicate no STBC ($N_{STS} = N_{SS}$). See NOTE 1.
FEC coding	1	Set to 1 for LDPC. Set to 0 for BCC.
Short GI	1	Set to 1 to indicate that the short GI is used after the HT training. Set to 0 otherwise.

(Source: <http://luci.subsignal.org/~jow/802.11n-2009.pdf>)

20.3.11.10.5 Transmission with a short GI

Short GI is used in the data field of the packet when the Short GI field in the HT-SIG is set to 1. When it is used, the same formula for the formation of the signal shall be used as in 20.3.11.10.2, 20.3.11.10.3, and 20.3.11.10.4, with T_{GI} replaced by T_{GIS} and T_{SYM} replaced by T_{SYMS} .

(Source: <http://luci.subsignal.org/~jow/802.11n-2009.pdf>)

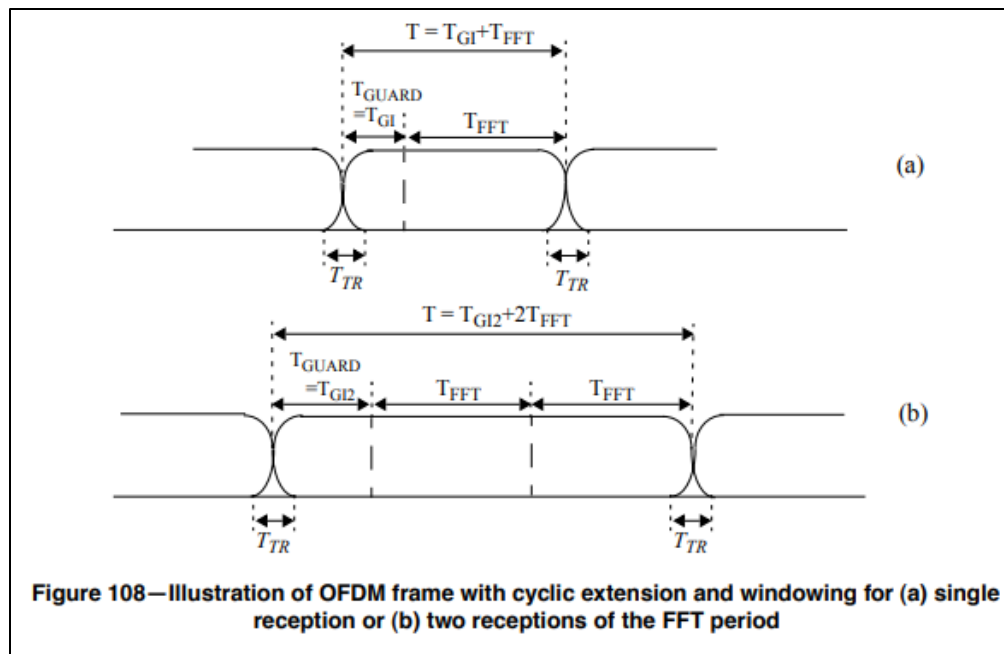

(Source: <http://www.ahltek.com/WhitePaperspdf/802.11-20%20specs/802.11a-1999.pdf>)

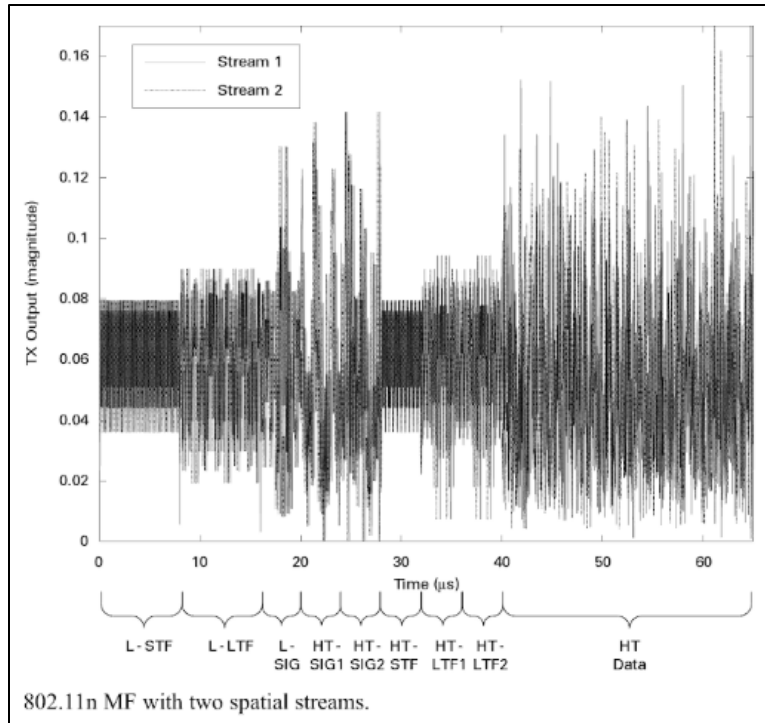

(Source: Next Generation Wireless LANs: 802.11n and 802.11ac, Perahia, Eldad and Stacey, Robert)

44. Legrand has had actual knowledge of the ‘304 Patent at least as of the date when it was notified of the filing of this action. By the time of trial, Legrand will have known and intended (since receiving such notice) that its continued actions would infringe and actively induce and contribute to the infringement of one or more claims of the ‘304 Patent.

45. Legrand has also indirectly and willfully infringed, and continues to indirectly and willfully infringe, the ‘304 Patent, as explained further below in the “Additional Allegations Regarding Infringement” section.

46. American Patents has been damaged as a result of the infringing conduct by Legrand alleged above. Thus, Legrand is liable to American Patents in an amount that adequately compensates it for such infringements, which, by law, cannot be less than a reasonable royalty, together with interest and costs as fixed by this Court under 35 U.S.C. § 284.

47. American Patents has neither made nor sold unmarked articles that practice the ‘304 Patent, and is entitled to collect pre-filing damages for the full period allowed by law for infringement of the ‘304 Patent.

COUNT III

INFRINGEMENT OF U.S. PATENT NO. 7,706,458

48. On April 27, 2010, United States Patent No. 7,706,458 (“the ‘458 Patent”) was duly and legally issued by the United States Patent and Trademark Office for an invention entitled “Time And Frequency Synchronization In Multi-Input, Multi-Output (MIMO) Systems.”

49. American Patents is the owner of the ‘458 Patent, with all substantive rights in and to that patent, including the sole and exclusive right to prosecute this action and enforce the ‘458 Patent against infringers, and to collect damages for all relevant times.

50. Legrand made, had made, used, imported, provided, supplied, distributed, sold, and/or offered for sale products and/or systems including, for example, its Legrand DA1104NP 802.11ac Low Profile Wireless Access Point, Legrand Luxul WS-250 Series Wireless Router Kit, and Legrand MK-10 Epic Mesh Node Kit families of products that include 802.11n and above capabilities (“accused products”):

Global ▾ Our Brands ▾ Where To Buy Support Newsroom

legrand PRODUCTS MARKETS SOLUTIONS IDEAS TOOLS & RESOURCES

802.11ac Low Profile Wireless Access Point (POE Injector not included)

DA1104NP | On-Q

★★★★★ (0) Write a review

This indoor, dual-band access point offers the fastest wireless speeds with the latest Wi-Fi standard, 802.11ac. It delivers single stream data rates of up to 867Mbps (5 GHz) with a total streaming capacity of 1.2Gbps. The DA1104 is a 2x2

APPLICATION SECTOR: Residential

Residential

WHERE TO BUY

Send Save as PDF Favorite this

(Source : <https://www.legrand.us/networking/wireless-networking/legrand-wireless-access-points/80211ac-low-profile-wireless-access-point-poe-injector-not-included/p/da1104np>)



Roll over image to zoom



Wireless Router Kit - EPIC 3 AC3100 Wireless Router & Controller W/ Domotz, Router Limits and XAP-1510 AC1900 Access Point with US Power Cord

WS-250 Series | SKU: WS-250

LUXUL.



This wireless AV router kit combines high output power and simple deployment. The Luxul WS-250 offers the Epic 3 dual-band wireless AC3100 gigabit router, and the high-power AC1900 XAP-1510 access point. Including 802.11ac wireless coverage, Domotz remote AV management, family scheduling with Router Limits and roaming is solved with the built-in wireless AV controller with Roam Assist™. The WS-250 is a truly exceptional Wi-Fi experience.

The Luxul WS-250 comes with (1) Epic 3, (1) XAP-1510 and (1) PoE Injector.

Features:

- Roaming solved with Luxul Roam Assist™
- Supports up to two access points
- High power for maximum coverage
- Concurrent dual-band wireless 802.11ac
- 4x4 dual-band MIMO
- Wireless data transfers of up to 3100Mbps
- 2.4Ghz & 5GHz beamforming

(Source :

https://www.legrandav.com/products/wireless/wireless_kits/wireless_router_kit_epic_3_ac3100_domotz_router_limits_xap-1510_ac1900/ws-250#sort=relevancy&numberOfResults=20)



Roll over image to zoom

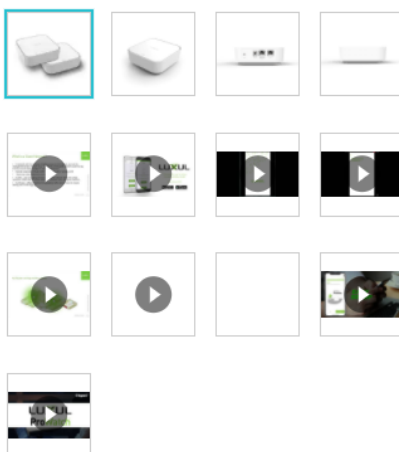

MK-10 Epic Mesh Node Kit

MK-10 Series | SKU: MK-10

LUXUL

The Wireless Mesh Kit combines the power of a Luxul wireless product with the ease of retail networking solutions. This kit can be used as a small mesh network, or as an additional/replacement nodes to extend an existing mesh network. Just plug them into an available outlet and use the Luxul Easy Setup App on your iOS or Android smartphone to define how the devices will be used: router or node. The powerful 4x4 5GHz dedicated backhaul channel ensures strong connectivity to deliver fast internet anywhere in the home.

Epic Mesh Features:

- ProWatch+ meaning you can remotely monitor and manage all connected devices on the network - from anywhere! Save time and money by using ProWatch and avoid unnecessary truck rolls
- 4x4 backhaul which allows for better communication between nodes, meaning less network congestion and faster WiFi speeds
- 8 SSIDs that can be individually named to provide you with options for setting up the network. Whether you need a separate guest network or want to keep the home automation devices apart from other network devices, you can easily do so
- Lifetime tech support
- 3-year limited warranty

This Kit Includes:

- Two (2) Epic Mesh nodes

(Source : https://www.legrandav.com/products/wireless/epic-mesh/epic_mesh_mk-10/mk-10#sort=relevancy&numberOfResults=20)

Technical Information

Data Transfer Rate	1.2 bps
Compatibility	IEEE 802.11a/b/g/n/ac- 802.3af/at Power over Ethernet
Processor	8.07
Number of Ports	32
Antenna	Dual Band: 2x2 MU-MIMO, Omni-directional

(Source : <https://www.legrand.us/networking/wireless-networking/legrand-wireless-access-points/80211ac-low-profile-wireless-access-point-poe-injector-not-included/p/dal104np>)

Specifications

Specifications for Wireless Router Kit - EPIC 3 AC3100 Wireless Router & Controller W/ Domotz, Router Limits and XAP-1510 AC1900 Access Point with US Power Cord

Dimensions & Measurements	Operating Temperature	32° to 122°F (0° to 50°C)
Characteristics & Features	Access Point Location	Indoor
	Antenna Type	<ul style="list-style-type: none"> • 4x4 MU-MIMO Wave 2 • Beamforming
	Connection Type	<ul style="list-style-type: none"> • Wired • Wireless

(Source :

https://www.legrandav.com/products/wireless/wireless_kits/wireless_router_kit_epic_3_ac3100_domotz_router_limits_xap-1510_ac1900/ws-250#sort=relevancy&numberOfResults=20)

Wireless Speed	2.4GHz - 1.0Gbps* 5GHz - 2.167Gbps*
Wireless Security	Open, WPA, WPA2, WPA/WPA2 mixed
Other Functions and Features	<ul style="list-style-type: none"> ▶ WPA encryption, DHCP, IPV6, NAT, VPN passthrough, UPnP, WAN static IP, WAN PPPoE, WAN VLAN tagging, static leases, port forwarding, DMZ, wireless guest network, band steering, client roaming, airtime fairness, adaptive path selection ▶ Backup and restore configurations ▶ Firmware upgradeable ▶ MU-MIMO with Beamforming

(Source : <https://catalog.avispl.com/SLIS/pdfs/Luxul/LUXMK10.pdf>)

51. By doing so, Legrand has directly infringed (literally and/or under the doctrine of equivalents) at least Claim 1 of the ‘458 Patent. Legrand’s infringement in this regard is ongoing.

52. Legrand has infringed the ‘458 Patent by making, having made, using, importing, providing, supplying, distributing, selling or offering for sale products including an apparatus for synchronizing a communication system. For example, the accused products can act and have acted as a receiver in an apparatus for synchronizing a communication system. An 802.11 n/ac compliant WiFi access point that is communicating with an accused product can be part of the apparatus, acting as a transmitter. The accused products support IEEE 802.11 n/ac standards and MIMO technology. The IEEE 802.11ac standard is backwards compatible with the 802.11n standard. If a device such as an accused product complies with IEEE 802.11ac, it also complies with IEEE 802.11n and all prior versions of the WiFi standards (802.11 a/b/g/n). According to the 802.11a standard, the physical layer services include an OFDM system. According to the IEEE 802.11n standard, all Protocol Data Unit (PPDU) frame formats have training fields and signaling fields which would help in synchronizing the communication system.

The introduction of 802.11ac expands the compatibility matrix in the 5 GHz band from two concurrently operating technologies to three, and the compatibility considerations in a broadcast network medium extend not only to intended receivers but to any receiver. Table 3-4 describes the compatibility between transmitters of frames and their intended receivers. That is, if a transmitter of the type in the left column sends a frame directed to a receiver of the type in any of the other three columns, what will the result be? One of the major methods used to support coexistence is backward compatibility. When built, 802.11ac devices will also incorporate 802.11a and 802.11n data rates, and thus will be able to send to older peers at older data rates.

(Source: 802.11ac: A Survival Guide: Wi-Fi at Gigabit and Beyond, Gast, Matthew S.)

Table 3-5. Compatibility between transmitters and listening devices

Transmitter type	802.11a listener	802.11n listener	802.11ac listener
802.11a	Designed operation	802.11n devices listen to 802.11a frames and defer medium access to avoid collisions	802.11ac devices listen to 802.11a frames and defer medium access to avoid collisions
802.11n	802.11n greenfield frames require RTS/CTS or CTS-to-self protection; 802.11n mixed-mode frames require no special protection	Designed operation	802.11ac devices listen to 802.11n frames and defer medium access to avoid collisions
802.11ac	802.11ac uses a compatible physical preamble, allowing 802.11a devices to read the medium as busy and avoid collisions	802.11ac uses a compatible preamble, allowing 802.11n devices to read the medium as busy and avoid collisions	Designed operation

(Source: 802.11ac: A Survival Guide: Wi-Fi at Gigabit and Beyond, Gast, Matthew S.)

17.1.1 Scope

This subclause describes the PHY services provided to the IEEE 802.11 wireless LAN MAC by the 5 GHz (bands) OFDM system. The OFDM PHY layer consists of two protocol functions, as follows:

- a) A PHY convergence function, which adapts the capabilities of the physical medium dependent (PMD) system to the PHY service. This function is supported by the physical layer convergence procedure (PLCP), which defines a method of mapping the IEEE 802.11 PHY sublayer service data units (PSDU) into a framing format suitable for sending and receiving user data and management information between two or more stations using the associated PMD system.
- b) A PMD system whose function defines the characteristics and method of transmitting and receiving data through a wireless medium between two or more stations, each using the OFDM system.

(Source: https://standards.ieee.org/standard/802_11a-1999.html)

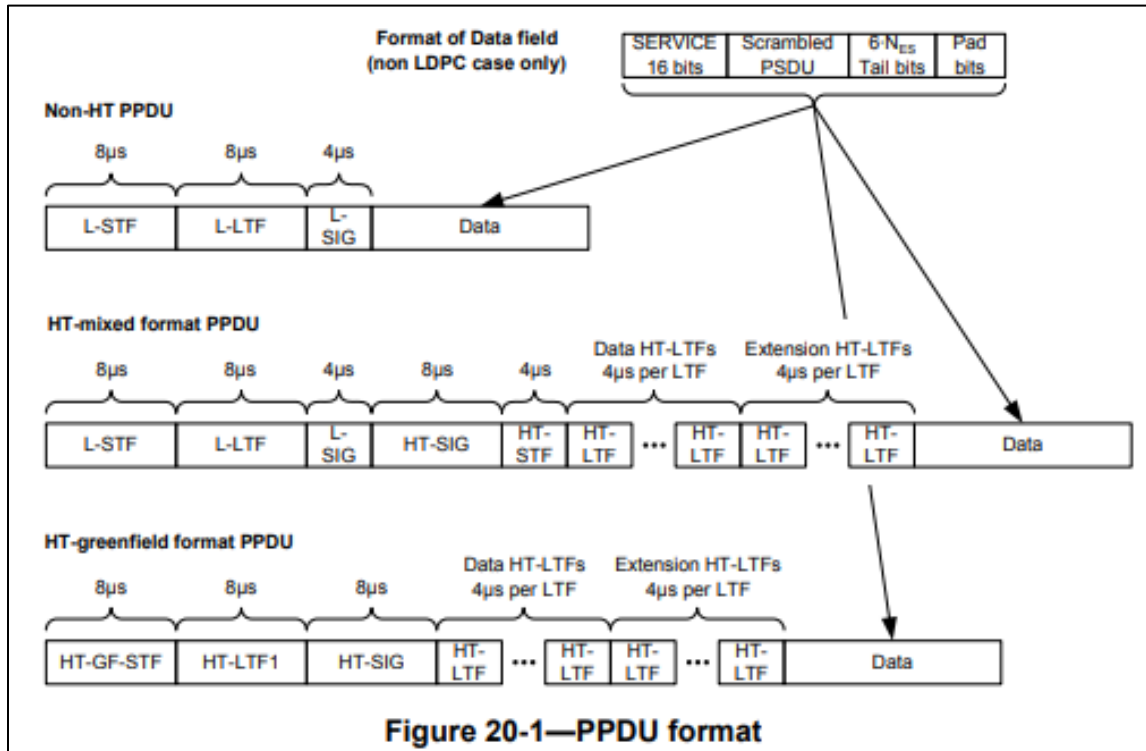

(Source: <http://luci.subsignal.org/~jow/802.11n-2009.pdf>)

The fields of the VHT PPDU format are summarized in Table 22-4.

Table 22-4—Fields of the VHT PPDU

Field	Description
L-STF	Non-HT Short Training field
L-LTF	Non-HT Long Training field
L-SIG	Non-HT SIGNAL field
VHT-SIG-A	VHT Signal A field
VHT-STF	VHT Short Training field
VHT-LTF	VHT Long Training field
VHT-SIG-B	VHT Signal B field
Data	The Data field carries the PSDU(s)

(Source: <https://ieeexplore.ieee.org/document/7797535/>)

53. The accused products include a number (Q) of Orthogonal Frequency Division Multiplexing (OFDM) modulators, each OFDM modulator producing a frame having at least one inserted symbol, a plurality of data symbols, and cyclic prefixes. According to the IEEE 802.11n standard, a transmitter block contains different functional blocks which include, but are not limited to, constellation mappers, IDFT stage, and Guard interval insertion. Constellation mappers map the bits and the constellation points for different modulation schemes like QPSK, BPSK, 16-QAM, 64-QAM. After modulating the signal, it is converted into time domain and is transmitted as frames of data. These transmitted frames include training field bits, signal bits, cyclic prefixes and data bits. Alternatively, on request from an accused product, an 802.11 n/ac compliant WiFi access point can act as a transmitter that includes a number (Q) of OFDM modulators, each OFDM modulator producing a frame having at least one inserted symbol, a plurality of data symbols, and cyclic prefixes.

20.3.3 Transmitter block diagram

HT-mixed format and HT-greenfield format transmissions can be generated using a transmitter consisting of the following blocks:

- a) *Scrambler* scrambles the data to reduce the probability of long sequences of zeros or ones; see 20.3.11.2.
- b) *Encoder parser*, if BCC encoding is to be used, demultiplexes the scrambled bits among N_{ES} (number of BCC encoders for the Data field) BCC encoders, in a round robin manner.
- c) *FEC encoders* encode the data to enable error correction. An FEC encoder may include a binary convolutional encoder followed by a puncturing device, or it may include an LDPC encoder.
- d) *Stream parser* divides the outputs of the encoders into blocks that are sent to different interleaver and mapping devices. The sequence of the bits sent to an interleaver is called a *spatial stream*.
- e) *Interleaver* interleaves the bits of each spatial stream (changes order of bits) to prevent long sequences of adjacent noisy bits from entering the BCC decoder. Interleaving is applied only when BCC encoding is used.
- f) *Constellation mapper* maps the sequence of bits in each spatial stream to constellation points (complex numbers).
- g) *STBC encoder* spreads constellation points from N_{SS} spatial streams into N_{STS} space-time streams using a space-time block code. STBC is used only when $N_{SS} < N_{STS}$; see 20.3.11.8.1.
- h) *Spatial mapper* maps space-time streams to transmit chains. This may include one of the following:
 - 1) *Direct mapping*: Constellation points from each space-time stream are mapped directly onto the transmit chains (one-to-one mapping).

(Source: <http://luci.subsignal.org/~jow/802.11n-2009.pdf>)

The encoding process is composed of the steps described below. The following overview is intended to facilitate an understanding of the details of the convergence procedure:

- a) Determine the number of transmit chains, N_{TX} , from the N_{TX} field of the TXVECTOR. Produce the PLCP preamble training fields for each of the N_{TX} transmit chains based on the FORMAT, NUM_EXTEN_SS, CH_BANDWIDTH, and MCS parameters of the TXVECTOR. The format and relative placement of the PLCP preamble training fields vary depending on the frame format being used, as indicated by these parameters. Apply cyclic shifts. Determine spatial mapping to be used for HT-STF and HT-LTFs in HT-mixed format frame and HT-GF-STF and HT-LTFs in HT-greenfield format frame from the EXPANSION_MAT parameter of the TXVECTOR. Refer to 20.3.9 for details.
- b) Construct the PLCP preamble SIGNAL fields from the appropriate fields of the TXVECTOR by adding tail bits, applying convolutional coding, formatting into one or more OFDM symbols, applying cyclic shifts, applying spatial processing, calculating an inverse Fourier transform for each OFDM symbol and transmit chain, and prepending a cyclic prefix or GI to each OFDM symbol in each transmit chain. The number and placement of the PLCP preamble SIGNAL fields depend on the frame format being used. Refer to 20.3.9.3.5, 20.3.9.4.3, and 20.3.9.5.3.
- c) Concatenate the PLCP preamble training and SIGNAL fields for each transmit chain one field after another, in the appropriate order, as described in 20.3.2 and 20.3.7.

(Source: <http://luci.subsignal.org/~jow/802.11n-2009.pdf>)

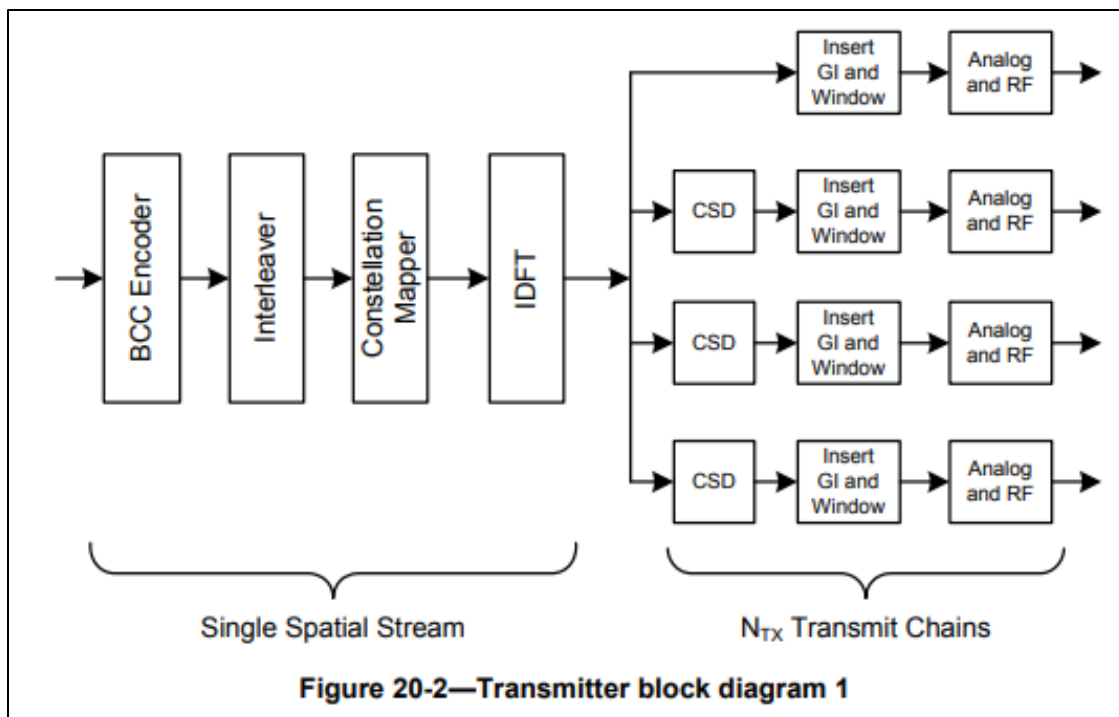

(Source: <http://luci.subsignal.org/~jow/802.11n-2009.pdf>)

54. The accused products include Q transmitting antennas, each transmitting antenna connected to a respective OFDM modulator, the transmitting antennas configured to transmit a respective frame over a channel. The accused products support MIMO and comply with IEEE 802.11 a/b/g/n/ac standards. The transmitting antennas transmit multiple OFDM frames over a channel. The transmitting antennas are connected to OFDM modulators to transmit the OFDM frames over a channel. Alternatively, on request from an accused product, a WiFi access point acts as a device that includes Q transmitting antennas, each transmitting antenna connected to a respective OFDM modulator, the transmitting antennas configured to transmit a respective frame over a channel.

Technical Information

Data Transfer Rate	1.2 bps
Compatibility	IEEE 802.11a/b/g/n/ac- 802.3af/at Power over Ethernet
Processor	8.07
Number of Ports	32
Antenna	Dual Band: 2x2 MU-MIMO, Omni-directional

(Source : <https://www.legrand.us/networking/wireless-networking/legrand-wireless-access-points/80211ac-low-profile-wireless-access-point-poe-injector-not-included/p/dal104np>)

Specifications

Specifications for Wireless Router Kit - EPIC 3 AC3100 Wireless Router & Controller W/ Domotz, Router Limits and XAP-1510 AC1900 Access Point with US Power Cord

Dimensions & Measurements	Operating Temperature	32° to 122°F (0° to 50°C)
Characteristics & Features	Access Point Location	Indoor
	Antenna Type	<ul style="list-style-type: none"> • 4x4 MU-MIMO Wave 2 • Beamforming
	Connection Type	<ul style="list-style-type: none"> • Wired • Wireless

(Source :

https://www.legrandav.com/products/wireless/wireless_kits/wireless_router_kit_epic_3_ac3100_domotz_router_limits_xap-1510_ac1900/ws-250#sort=relevancy&numberOfResults=20)

Wireless Speed	2.4GHz - 1.0Gbps* 5GHz - 2.167Gbps*
Wireless Security	Open, WPA, WPA2, WPA/WPA2 mixed
Other Functions and Features	<ul style="list-style-type: none"> ▶ WPA encryption, DHCP, IPV6, NAT, VPN passthrough, UPnP, WAN static IP, WAN PPPoE, WAN VLAN tagging, static leases, port forwarding, DMZ, wireless guest network, band steering, client roaming, airtime fairness, adaptive path selection ▶ Backup and restore configurations ▶ Firmware upgradeable ▶ MU-MIMO with Beamforming

(Source : <https://catalog.avispl.com/SLIS/pdfs/Luxul/LUXMK10.pdf>)

20.3.4 Overview of the PPDU encoding process

The encoding process is composed of the steps described below. The following overview is intended to facilitate an understanding of the details of the convergence procedure:

- a) Determine the number of transmit chains, N_{TX} , from the N_TX field of the TXVECTOR. Produce the PLCP preamble training fields for each of the N_{TX} transmit chains based on the FORMAT, NUM_EXTEN_SS, CH_BANDWIDTH, and MCS parameters of the TXVECTOR. The format and relative placement of the PLCP preamble training fields vary depending on the frame format being used, as indicated by these parameters. Apply cyclic shifts. Determine spatial mapping to be used for HT-STF and HT-LTFs in HT-mixed format frame and HT-GF-STF and HT-LTFs in HT-greenfield format frame from the EXPANSION_MAT parameter of the TXVECTOR. Refer to 20.3.9 for details.
- b) Construct the PLCP preamble SIGNAL fields from the appropriate fields of the TXVECTOR by adding tail bits, applying convolutional coding, formatting into one or more OFDM symbols, applying cyclic shifts, applying spatial processing, calculating an inverse Fourier transform for each OFDM symbol and transmit chain, and prepending a cyclic prefix or GI to each OFDM symbol in each transmit chain. The number and placement of the PLCP preamble SIGNAL fields depend on the frame format being used. Refer to 20.3.9.3.5, 20.3.9.4.3, and 20.3.9.5.3.
- c) Concatenate the PLCP preamble training and SIGNAL fields for each transmit chain one field after another, in the appropriate order, as described in 20.3.2 and 20.3.7.

(Source: <http://luci.subsignal.org/~jow/802.11n-2009.pdf>)

55. The accused products include a number (L) of receiving antennas for receiving the transmitted frames. For example, the accused products support MIMO and comply with 802.11 a/b/g/n/ac WiFi standards. The receiving antennas receive the transmitted frames.

Technical Information

Data Transfer Rate	1.2 bps
Compatibility	IEEE 802.11a/b/g/n/ac- 802.3af/at Power over Ethernet
Processor	8.07
Number of Ports	32
Antenna	Dual Band: 2x2 MU-MIMO, Omni-directional

(Source : <https://www.legrand.us/networking/wireless-networking/legrand-wireless-access-points/80211ac-low-profile-wireless-access-point-poe-injector-not-included/p/dal104np>)

Specifications

Specifications for Wireless Router Kit - EPIC 3 AC3100 Wireless Router & Controller W/ Domotz, Router Limits and XAP-1510 AC1900 Access Point with US Power Cord

Dimensions & Measurements	Operating Temperature	32° to 122°F (0° to 50°C)
Characteristics & Features	Access Point Location	Indoor
	Antenna Type	<ul style="list-style-type: none"> • 4x4 MU-MIMO Wave 2 • Beamforming
	Connection Type	<ul style="list-style-type: none"> • Wired • Wireless

(Source :

https://www.legrandav.com/products/wireless/wireless_kits/wireless_router_kit_epic_3_ac3100_domotz_router_limits_xap-1510_ac1900/ws-250#sort=relevancy&numberOfResults=20)

Wireless Speed	2.4GHz - 1.0Gbps* 5GHz - 2.167Gbps*
Wireless Security	Open, WPA, WPA2, WPA/WPA2 mixed
Other Functions and Features	<ul style="list-style-type: none"> ▶ WPA encryption, DHCP, IPV6, NAT, VPN passthrough, UPnP, WAN static IP, WAN PPPoE, WAN VLAN tagging, static leases, port forwarding, DMZ, wireless guest network, band steering, client roaming, airtime fairness, adaptive path selection ▶ Backup and restore configurations ▶ Firmware upgradeable ▶ MU-MIMO with Beamforming

(Source : <https://catalog.avispl.com/SLIS/pdfs/Luxul/LUXMK10.pdf>)

56. The accused products include L OFDM demodulators, each OFDM demodulator corresponding to a respective receiving antenna, the L OFDM demodulators including a synchronization circuit that processes the received frame in order to synchronize the received frame in both time domain and frequency domain. For example, there is a demodulator block for performing demodulation on the received frames. Further, synchronizing the received frame in time and frequency domains occurs. In an OFDM transmitter section, a modulated signal is converted into time domain and is transmitted as multiple frames of data. The functional blocks present at the receiver end processes the received data, converts the data into frequency domain, and performs demodulation. Various signal bits present in the transmitted frames' preamble helps in demodulating the signal. A demodulator block is present at the receiver to perform demodulation. Different fields of data like training bits, cyclic prefixes and other signal bits present in the received frame helps in synchronizing the frame in both time and frequency domain. There is a synchronization circuit which processes the received frame and synchronizes them in both time and frequency domain.

20.3.1 Introduction

A convergence procedure, in which PSDUs are converted to and from PPDU, is provided for the HT PHY in 20.3. During transmission, the PSDU is processed (i.e., scrambled and coded) and appended to the PLCP preamble to create the PPDU. At the receiver, the PLCP preamble is processed to aid in demodulation and delivery of the PSDU.

Two preamble formats are defined. For HT-mixed format operation, the preamble has a non-HT portion and an HT portion. The non-HT portion of the HT-mixed format preamble enables detection of the PPDU and acquisition of carrier frequency and timing by both HT STAs and STAs that are compliant with Clause 17 and/or Clause 19. The non-HT portion of the HT-mixed format preamble also consists of the SIGNAL field defined in Clause 17 and is thus decodable by STAs compliant with Clause 17 and Clause 19 as well as HT STAs.

(Source: <http://luci.subsignal.org/~jow/802.11n-2009.pdf>)

3.244 receive chain: The physical entity that implements any necessary signal processing to provide the received signal to the digital baseband. Such signal processing includes filtering, amplification, down-conversion, and sampling.

3.245 sounding: The use of preamble training fields to measure the channel for purposes other than demodulation of the Data portion of the physical layer convergence procedure (PLCP) protocol data unit (PPDU) containing the training fields.

NOTE—These uses include calculation of transmit steering, calculation of recommended MCS, and calculation of calibration parameters.

(Source: <http://luci.subsignal.org/~jow/802.11n-2009.pdf>)

The encoding process is composed of the steps described below. The following overview is intended to facilitate an understanding of the details of the convergence procedure:

- a) Determine the number of transmit chains, N_{TX} , from the N_TX field of the TXVECTOR. Produce the PLCP preamble training fields for each of the N_{TX} transmit chains based on the FORMAT, NUM_EXTEN_SS, CH_BANDWIDTH, and MCS parameters of the TXVECTOR. The format and relative placement of the PLCP preamble training fields vary depending on the frame format being used, as indicated by these parameters. Apply cyclic shifts. Determine spatial mapping to be used for HT-STF and HT-LTFs in HT-mixed format frame and HT-GF-STF and HT-LTFs in HT-greenfield format frame from the EXPANSION_MAT parameter of the TXVECTOR. Refer to 20.3.9 for details.
- b) Construct the PLCP preamble SIGNAL fields from the appropriate fields of the TXVECTOR by adding tail bits, applying convolutional coding, formatting into one or more OFDM symbols, applying cyclic shifts, applying spatial processing, calculating an inverse Fourier transform for each OFDM symbol and transmit chain, and prepending a cyclic prefix or GI to each OFDM symbol in each transmit chain. The number and placement of the PLCP preamble SIGNAL fields depend on the frame format being used. Refer to 20.3.9.3.5, 20.3.9.4.3, and 20.3.9.5.3.
- c) Concatenate the PLCP preamble training and SIGNAL fields for each transmit chain one field after another, in the appropriate order, as described in 20.3.2 and 20.3.7.

(Source: <http://luci.subsignal.org/~jow/802.11n-2009.pdf>)

- a) Detect the start of frame.
- b) Detect the transition from short sequences to channel estimation sequences, and establish fine timing (with one sample resolution).
- c) Estimate the coarse and fine frequency offsets.
- d) Derotate the frame according to estimated frequency offset.
- e) Estimate the complex channel response coefficients for each of the subcarriers and each of the transmit chains.
- f) For each of the data OFDM symbols, transform the symbol into subcarrier received values, estimate the phase from the pilot subcarriers in all spatial streams, derotate the subcarrier values according to estimated phase, group the results from all the receiver chains in each subcarrier to a vector, multiply the vector by a zero-forcing equalization matrix generated from the channel estimated during the channel estimation phase.
- g) For each data-carrying subcarrier in each spatial stream, find the closest constellation point and compute the Euclidean distance from it.
- h) Compute the average of the RMS of all errors in a frame. It is given by Equation (20-89).

(Source: <http://luci.subsignal.org/~jow/802.11n-2009.pdf>)

57. The accused products include wherein each of the L OFDM demodulators comprises a pre-amplifier, a local oscillator, a mixer having a first input and a second input, the

first input connected to an output of the pre-amplifier, the second input connected to an output of the local oscillator, an analog-to-digital converter (ADC) connected to an output of the mixer. The demodulating section at the receiver end includes a pre-amplifier, a local oscillator, a mixer, and an ADC. The received frames undergo filtering, amplification (pre-amplifier), down-conversion and sampling (ADC). There are respective functional blocks for performing these functions. After transmitting the data, the data is received by a receiving antenna for further processing. To prevent the demodulator from demodulating the noise associated with the received signal, an RF front end circuit is implemented to increase the SNR of the demodulated signal. The RF front end circuit generally consists of amplifiers, local oscillator, filters and mixers. The output from the mixer is generally fed to an analog-to-digital converter (ADC). This RF front end circuit generally lies at the start of the demodulation process.

3.244 receive chain: The physical entity that implements any necessary signal processing to provide the received signal to the digital baseband. Such signal processing includes filtering, amplification, down-conversion, and sampling.

3.245 sounding: The use of preamble training fields to measure the channel for purposes other than demodulation of the Data portion of the physical layer convergence procedure (PLCP) protocol data unit (PPDU) containing the training fields.

NOTE—These uses include calculation of transmit steering, calculation of recommended MCS, and calculation of calibration parameters.

(Source: <http://luci.subsignal.org/~jow/802.11n-2009.pdf>)

The technique to combat a low $\text{SNR}_{\text{demod_in}}$ is by adding a front end block, which processes (conditions) the received signal/AWGN/interference before admitting it to the demodulator. This processing can be done in several ways:

(Source: VLSI for Wireless Communication)

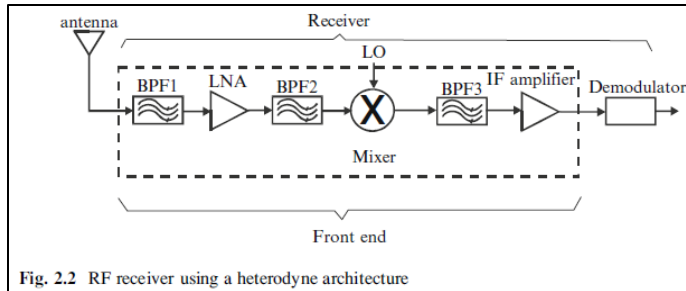

(Source: VLSI for Wireless Communication)

2.4 Rest of Receiver Front End: Nonidealities and Design Parameters

Now that we have talked about the design of filters in the receiver front, we turn our attention to the design of the rest of the components. Normally these components consist of circuits such as LNA, mixer, IF amplifier, and analog/digital (A/D) converter. Unlike filters, their relevant design parameters are different. Hence our first task is to discuss these design parameters.

(Source: VLSI for Wireless Communication)

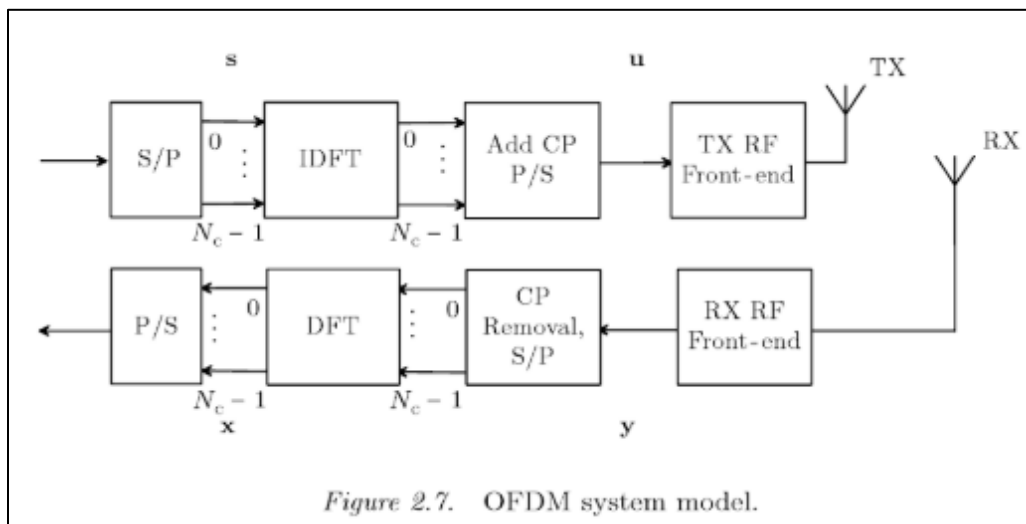

(Source: RF Imperfections in High-rate Wireless Systems: Impact and Digital Compression, Schenk, Tim)

The RF front end is generally defined as everything between the antenna and the digital baseband system. For a receiver, this "between" area includes all the filters, low-noise amplifiers (LNAs), and down-conversion mixer(s) needed to process the modulated signals received at the antenna into signals suitable for input into the baseband analog-to-digital converter (ADC). For this reason, the RF front end is often called the analog-to-digital or RF-to-baseband portion of a receiver.

(Source: https://www.eetimes.com/document.asp?doc_id=1276331)

58. The accused products include the synchronization circuit having one input connected to an output of the ADC. The PPDU frames that are transmitted are demodulated at the receiver end. The demodulation process includes estimating time and frequency offsets and synchronizing accordingly.

- a) Detect the start of frame.
- b) Detect the transition from short sequences to channel estimation sequences, and establish fine timing (with one sample resolution).
- c) Estimate the coarse and fine frequency offsets.
- d) Derotate the frame according to estimated frequency offset.
- e) Estimate the complex channel response coefficients for each of the subcarriers and each of the transmit chains.
- f) For each of the data OFDM symbols, transform the symbol into subcarrier received values, estimate the phase from the pilot subcarriers in all spatial streams, derotate the subcarrier values according to estimated phase, group the results from all the receiver chains in each subcarrier to a vector, multiply the vector by a zero-forcing equalization matrix generated from the channel estimated during the channel estimation phase.
- g) For each data-carrying subcarrier in each spatial stream, find the closest constellation point and compute the Euclidean distance from it.
- h) Compute the average of the RMS of all errors in a frame. It is given by Equation (20-89).

(Source: <http://luci.subsignal.org/~jow/802.11n-2009.pdf>)

The RF front end is generally defined as everything between the antenna and the digital baseband system. For a receiver, this "between" area includes all the filters, low-noise amplifiers (LNAs), and down-conversion mixer(s) needed to process the modulated signals received at the antenna into signals suitable for input into the baseband analog-to-digital converter (ADC). For this reason, the RF front end is often called the analog-to-digital or RF-to-baseband portion of a receiver.

(Source: https://www.eetimes.com/document.asp?doc_id=1276331)

59. The accused products include a cyclic-prefix remover connected to an output of the synchronization circuit, a serial-to-parallel converter connected to an output of the cyclic prefix remover, and a discrete Fourier transform (DFT) stage connected to an output of the serial-to-parallel converter, an output of the DFT stage connected to another input to the synchronization circuit. Cyclic prefixes are added in the preamble for each transmitted frame. In a general OFDM system, a cyclic prefix remover circuit would be present at the receiver end. The output from the cyclic prefix remover circuit would be fed to a serial-to-parallel converter for performing a DFT operation on its output. The evidence also shows that the output of the DFT stage is connected to the phase correction block that is part of the synchronization circuit.

The encoding process is composed of the steps described below. The following overview is intended to facilitate an understanding of the details of the convergence procedure:

- a) Determine the number of transmit chains, N_{TX} , from the N_TX field of the TXVECTOR. Produce the PLCP preamble training fields for each of the N_{TX} transmit chains based on the FORMAT, NUM_EXTEN_SS, CH_BANDWIDTH, and MCS parameters of the TXVECTOR. The format and relative placement of the PLCP preamble training fields vary depending on the frame format being used, as indicated by these parameters. Apply cyclic shifts. Determine spatial mapping to be used for HT-STF and HT-LTFs in HT-mixed format frame and HT-GF-STF and HT-LTFs in HT-greenfield format frame from the EXPANSION_MAT parameter of the TXVECTOR. Refer to 20.3.9 for details.
- b) Construct the PLCP preamble SIGNAL fields from the appropriate fields of the TXVECTOR by adding tail bits, applying convolutional coding, formatting into one or more OFDM symbols, applying cyclic shifts, applying spatial processing, calculating an inverse Fourier transform for each OFDM symbol and transmit chain, and prepending a cyclic prefix or GI to each OFDM symbol in each transmit chain. The number and placement of the PLCP preamble SIGNAL fields depend on the frame format being used. Refer to 20.3.9.3.5, 20.3.9.4.3, and 20.3.9.5.3.
- c) Concatenate the PLCP preamble training and SIGNAL fields for each transmit chain one field after another, in the appropriate order, as described in 20.3.2 and 20.3.7.

(Source: <http://luci.subsignal.org/~jow/802.11n-2009.pdf>)

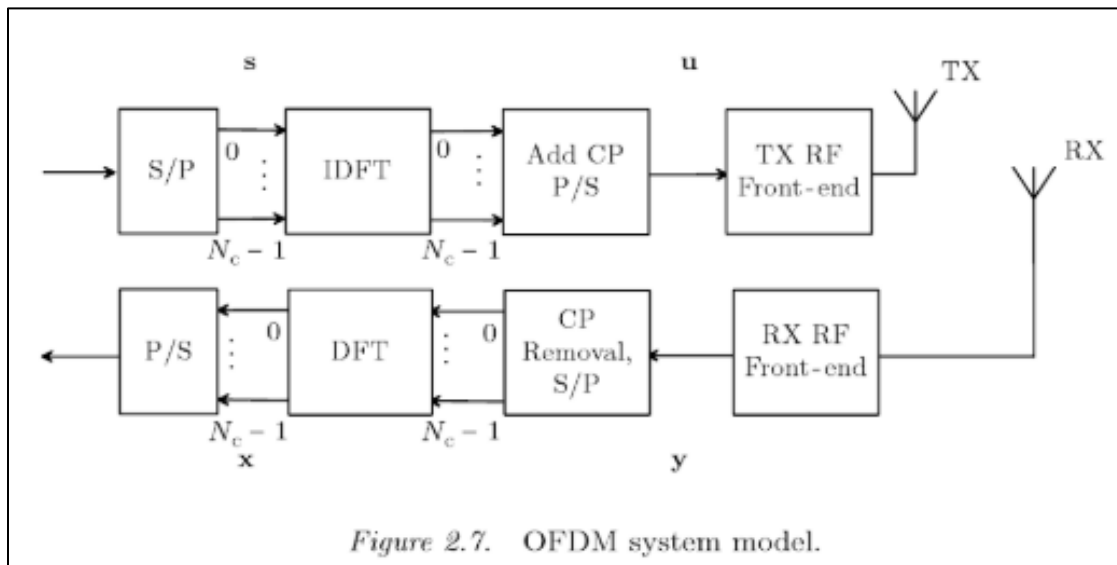

(Source: RF Imperfections in High-rate Wireless Systems: Impact and Digital Compression, Schenk, Tim)

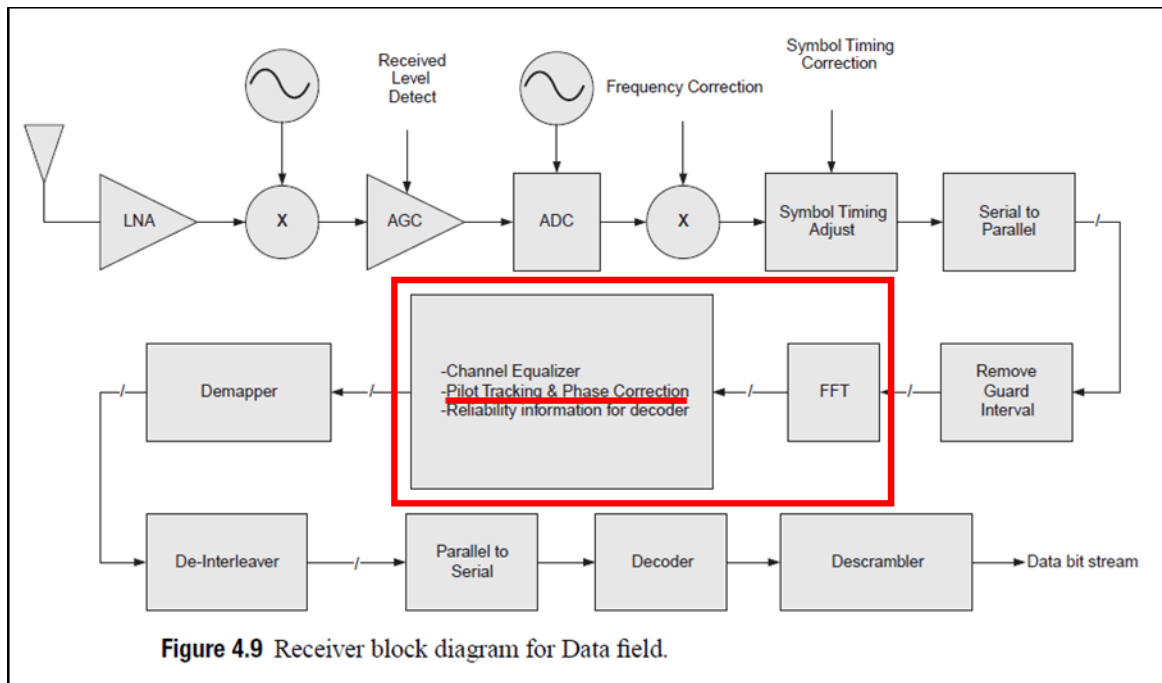

(Source: Next Generation Wireless LANs: 802.11n and 802.11ac, Perahia, Eldad and Stacey, Robert)

60. Legrand has had actual knowledge of the ‘458 Patent at least as of the date when it was notified of the filing of this action. By the time of trial, Legrand will have known and intended (since receiving such notice) that its continued actions would infringe and actively induce and contribute to the infringement of one or more claims of the ‘458 Patent.

61. Legrand has also indirectly and willfully infringed, and continues to indirectly and willfully infringe, the ‘458 Patent, as explained further below in the “Additional Allegations Regarding Infringement” section.

62. American Patents has been damaged as a result of the infringing conduct by Legrand alleged above. Thus, Legrand is liable to American Patents in an amount that adequately compensates it for such infringements, which, by law, cannot be less than a reasonable royalty, together with interest and costs as fixed by this Court under 35 U.S.C. § 284.

63. American Patents has neither made nor sold unmarked articles that practice the '458 Patent, and is entitled to collect pre-filing damages for the full period allowed by law for infringement of the '458 Patent.

COUNT IV

INFRINGEMENT OF U.S. PATENT NO. 6,847,803

64. On January 25, 2005, United States Patent No. 6,847,803 (“the ‘803 Patent”) was duly and legally issued by the United States Patent and Trademark Office for an invention entitled “Method for Reducing Interference in a Receiver.”

65. American Patents is the owner of the ‘803 Patent, with all substantive rights in and to that patent, including the sole and exclusive right to prosecute this action and enforce the ‘803 Patent against infringers, and to collect damages for all relevant times.

66. Legrand made, had made, used, imported, provided, supplied, distributed, sold, and/or offered for sale products and/or systems including, for example, its Legrand DA1104NP 802.11ac Low Profile Wireless Access Point, Legrand Luxul WS-250 Series Wireless Router Kit, and Legrand MK-10 Epic Mesh Node Kit families of products that include 802.11ac beamforming capabilities (“accused products”):

The screenshot shows the Legrand website's product page for the DA1104NP. The header includes the Legrand logo, navigation menus for 'Global', 'Our Brands', 'Where To Buy', 'Support', and 'Newsroom', and a main navigation bar with 'PRODUCTS', 'MARKETS', 'SOLUTIONS', 'IDEAS', and 'TOOLS & RESOURCES'. A search bar is also present. The product image is a circular, white, low-profile access point. The title is '802.11ac Low Profile Wireless Access Point (POE Injector not included)'. The model number is 'DA1104NP | On-Q'. There is a star rating of 5 stars with '(0) Write a review'. The description states: 'This indoor, dual-band access point offers the fastest wireless speeds with the latest Wi-Fi standard, 802.11ac. It delivers single stream data rates of up to 867Mbps (5 GHz) with a total streaming capacity of 1.2Gbps. The DA1104 is a 2x2'. The 'APPLICATION SECTOR' is 'Residential', with a corresponding button. A 'WHERE TO BUY' button is also visible. At the bottom of the product area, there are icons for 'Send', 'Save as PDF', and 'Favorite this'.

(Source : <https://www.legrand.us/networking/wireless-networking/legrand-wireless-access-points/80211ac-low-profile-wireless-access-point-poe-injector-not-included/p/da1104np>)



Roll over image to zoom



Wireless Router Kit - EPIC 3 AC3100 Wireless Router & Controller W/ Domotz, Router Limits and XAP-1510 AC1900 Access Point with US Power Cord

WS-250 Series | SKU: WS-250

LUXUL.



This wireless AV router kit combines high output power and simple deployment. The Luxul WS-250 offers the Epic 3 dual-band wireless AC3100 gigabit router, and the high-power AC1900 XAP-1510 access point. Including 802.11ac wireless coverage, Domotz remote AV management, family scheduling with Router Limits and roaming is solved with the built-in wireless AV controller with Roam Assist™. The WS-250 is a truly exceptional Wi-Fi experience.

The Luxul WS-250 comes with (1) Epic 3, (1) XAP-1510 and (1) PoE Injector.

Features:

- Roaming solved with Luxul Roam Assist™
- Supports up to two access points
- High power for maximum coverage
- Concurrent dual-band wireless 802.11ac
- 4x4 dual-band MIMO
- Wireless data transfers of up to 3100Mbps
- 2.4Ghz & 5GHz beamforming

(Source :

https://www.legrandav.com/products/wireless/wireless_kits/wireless_router_kit_epic_3_ac3100_domotz_router_limits_xap-1510_ac1900/ws-250#sort=relevancy&numberOfResults=20)



Roll over image to zoom

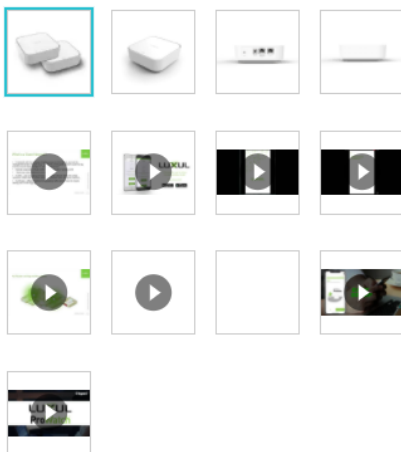

MK-10 Epic Mesh Node Kit

MK-10 Series | SKU: MK-10

LUXUL

The Wireless Mesh Kit combines the power of a Luxul wireless product with the ease of retail networking solutions. This kit can be used as a small mesh network, or as an additional/replacement nodes to extend an existing mesh network. Just plug them into an available outlet and use the Luxul Easy Setup App on your iOS or Android smartphone to define how the devices will be used: router or node. The powerful 4x4 5GHz dedicated backhaul channel ensures strong connectivity to deliver fast internet anywhere in the home.

Epic Mesh Features:

- ProWatch+ meaning you can remotely monitor and manage all connected devices on the network - from anywhere! Save time and money by using ProWatch and avoid unnecessary truck rolls
- 4x4 backhaul which allows for better communication between nodes, meaning less network congestion and faster WiFi speeds
- 8 SSIDs that can be individually named to provide you with options for setting up the network. Whether you need a separate guest network or want to keep the home automation devices apart from other network devices, you can easily do so
- Lifetime tech support
- 3-year limited warranty

This Kit Includes:

- Two (2) Epic Mesh nodes

(Source : https://www.legrandav.com/products/wireless/epic-mesh/epic_mesh_mk-10/mk-10#sort=relevancy&numberOfResults=20)

Technical Information

Data Transfer Rate	1.2 bps
Compatibility	IEEE 802.11a/b/g/n/ac- 802.3af/at Power over Ethernet
Processor	8.07
Number of Ports	32
Antenna	Dual Band: 2x2 MU-MIMO, Omni-directional

(Source : <https://www.legrand.us/networking/wireless-networking/legrand-wireless-access-points/80211ac-low-profile-wireless-access-point-poe-injector-not-included/p/dal104np>)

Specifications

Specifications for Wireless Router Kit - EPIC 3 AC3100 Wireless Router & Controller W/ Domotz, Router Limits and XAP-1510 AC1900 Access Point with US Power Cord

Dimensions & Measurements	Operating Temperature	32° to 122°F (0° to 50°C)
Characteristics & Features	Access Point Location	Indoor
	Antenna Type	<ul style="list-style-type: none"> • 4x4 MU-MIMO Wave 2 • Beamforming
	Connection Type	<ul style="list-style-type: none"> • Wired • Wireless

(Source :

https://www.legrandav.com/products/wireless/wireless_kits/wireless_router_kit_epic_3_ac3100_domotz_router_limits_xap-1510_ac1900/ws-250#sort=relevancy&numberOfResults=20)

Wireless Speed	2.4GHz - 1.0Gbps* 5GHz - 2.167Gbps*
Wireless Security	Open, WPA, WPA2, WPA/WPA2 mixed
Other Functions and Features	<ul style="list-style-type: none"> ▶ WPA encryption, DHCP, IPV6, NAT, VPN passthrough, UPnP, WAN static IP, WAN PPPoE, WAN VLAN tagging, static leases, port forwarding, DMZ, wireless guest network, band steering, client roaming, airtime fairness, adaptive path selection ▶ Backup and restore configurations ▶ Firmware upgradeable ▶ MU-MIMO with Beamforming

(Source : <https://catalog.avispl.com/SLIS/pdfs/Luxul/LUXMK10.pdf>)

Beamforming and MU-MIMO

Beamforming is key for the support of multiuser MIMO, or [MU-MIMO](#), which is becoming more popular as 802.11ax routers roll out. As the name implies, MU-MIMO involves multiple users that can each communicate to multiple antennas on the router. MU-MIMO [uses beamforming](#) to make sure communication from the router is efficiently targeted to each connected client.

(Source: <https://www.networkworld.com/article/3445039/beamforming-explained-how-it-makes-wireless-communication-faster.html>)

67. By doing so, Legrand has directly infringed (literally and/or under the doctrine of equivalents) at least Claim 1 of the ‘803 Patent.

68. Legrand has infringed the ‘803 Patent by using the accused products and thereby practicing a method for reducing interference in a receiver for receiving information in receiving time slots, in which receiver signals are received with at least a first antenna (ANT1) and a second antenna (ANT2). For example, the accused products are and have been used by Defendant to implement the IEEE 802.11-2016 Standard, whose requirements were in effect five years before the Complaint. Devices that can communicate using 802.11 protocol are known as Stations (STAs). Multiple Input Multiple Output (MIMO) and Beamforming techniques are and

have been used by a STA with multiple antennas for steering the signals to each STA (“receiver”) for reception. In such MIMO transmissions, the space-time streams in the transmitted signal would be intended for reception by each STA in its corresponding time slots. These time slots at which the STA receives the space-time streams with actual data information can be construed as receiving time slots. Since, there are multiple antennas, when they transmit simultaneously, the signal appears as interference at each of the receive antennas. Further, a STA will also be able to identify the space-time streams intended for other STAs that act as interference. STA uses the channel state information that is obtained by estimating a channel to reduce the interference caused by other space time streams. The beamforming calibration procedures (“method for reducing interference”) involves channel estimation and matrix calculations which help in reducing the interference in a receiver. Indeed, the IEEE 802.11-2016 Standard shows MIMO systems with two STAs (i.e., STA A and STA B) using multiple antennas (“a first antenna (ANT1) and a second antenna (ANT2)”) for receiving transmitted signals.

21.3.11.1 General

SU-MIMO and DL-MU-MIMO beamforming are techniques used by a STA with multiple antennas (the beamformer) to steer signals using knowledge of the channel to improve throughput. With SU-MIMO beamforming all space-time streams in the transmitted signal are intended for reception at a single STA. With DL-MU-MIMO beamforming, disjoint subsets of the space-time streams are intended for reception at different STAs.

(Source : IEEE 802.11-2016 Standard, p. 2578)

19.3.12 Beamforming

19.3.12.1 General

Beamforming is a technique in which the beamformer utilizes the knowledge of the MIMO channel to generate a steering matrix Q_k that improves reception in the beamformee.

(Source : IEEE 802.11-2016 Standard, p. 2392)

A STA is also able to identify the space-time streams intended for other STAs that act as interference. VHT-LTF symbols in the VHT MU PPDU are used to measure the channel for the space-time streams intended for the STA and can also be used to measure the channel for the interfering space-time streams. To successfully demodulate the space-time streams intended for the STA, the STA may use the channel state information for all space-time streams to reduce the effect of interfering space-time streams.

(Source : IEEE 802.11-2016 Standard, p. 2580)

(2) (STation) A client device in an 802.11 (Wi-Fi) wireless network such as a computer, laptop or smartphone. The term STA is sometimes used for the access point (AP) as well, in which case a STA is any device communicating via the 802.11 protocol. See [wireless LAN](#) and [access point](#).

(Source : <https://www.pcmag.com/encyclopedia/term/sta>)

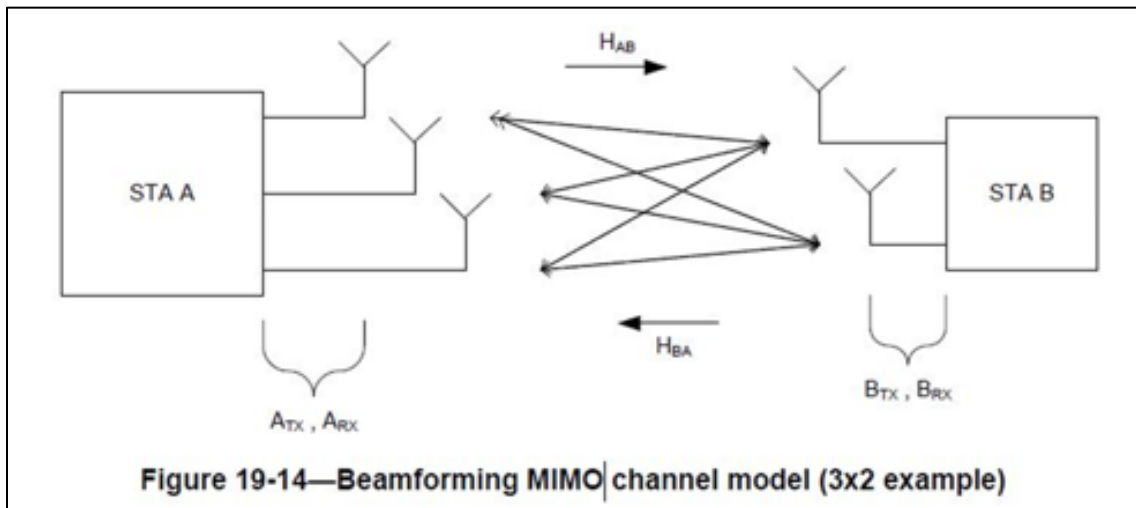

(Source : IEEE 802.11-2016 Standard, p. 2393)

69. The methods practiced by Legrand’s use of the accused products include methods where signals are received with said first antenna (ANT1) and second antenna (ANT2) at moments of time other than in said receiving time slot, when no information is being received. For example, the accused products are and have been used by Defendant to implement the IEEE 802.11-2016 Standard, whose requirements were in effect five years before the Complaint. A

STA in that Standard transmits data in PHY Protocol Data Units (PPDUs). PPDUs can be transmitted in High Throughput (HT) mode and Very High Throughput (VHT) mode. A Null Data Packet (NDP) can be transmitted in both HT and VHT Modes. Training Fields (TFs) inside the NDP carry no data related information and can be used as sounding PPDUs in beamforming calibration procedures. Sounding PPDUs would help in channel estimation at the STA. Certain TFs include the interference information which is used as reference during calibration procedures. The NDPs (“signals received”) in HT-PPDU and VHT PPDU format includes several TFs which are and have been used as a reference for the receiver to perform calibration/tuning. Thus, there is no actual data information that is received during the beamforming calibration procedures (“at moments of time other than in said receiving time slots”).

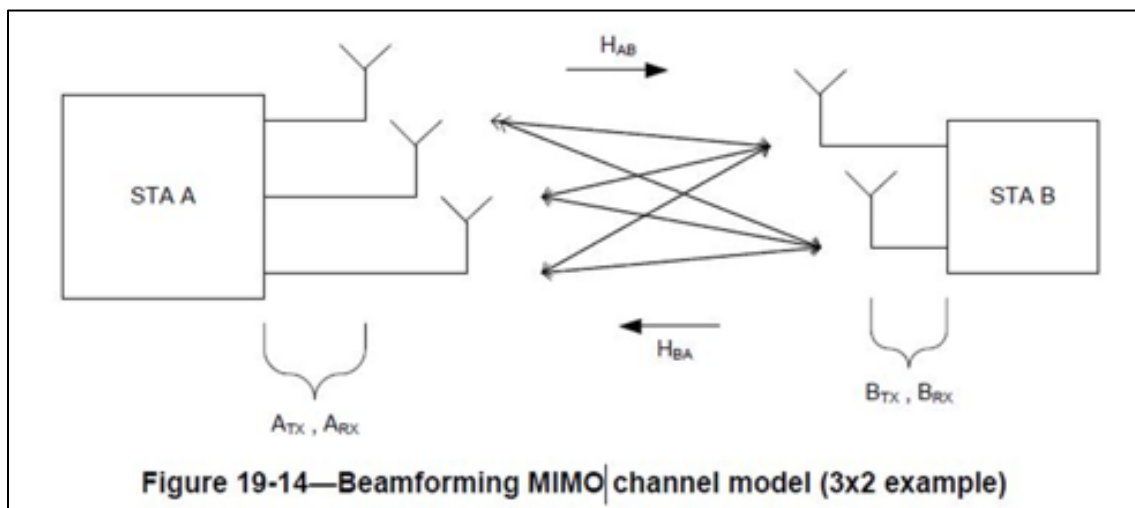

(Source : IEEE 802.11-2016 Standard, p. 2393)

Table 19-5—Elements of the HT PPDU

Element	Description
L-STF	Non-HT Short Training field
L-LTF	Non-HT Long Training field
L-SIG	Non-HT SIGNAL field
HT-SIG	HT SIGNAL field
HT-STF	HT Short Training field
HT-GF-STF	HT-Greenfield Short Training field
HT-LTF1	First HT Long Training field (Data)
HT-LTFs	Additional HT Long Training fields (Data and Extension)
Data	The Data field includes the PSDU

(Source : IEEE 802.11-2016 Standard, p. 2347)

Table 21-4—Fields of the VHT PPDU

Field	Description
L-STF	Non-HT Short Training field
L-LTF	Non-HT Long Training field
L-SIG	Non-HT SIGNAL field
VHT-SIG-A	VHT Signal A field
VHT-STF	VHT Short Training field
VHT-LTF	VHT Long Training field
VHT-SIG-B	VHT Signal B field
Data	The Data field carrying the PSDU(s)

The VHT-SIG-A, VHT-STF, VHT-LTF, and VHT-SIG-B fields exist only in VHT PPDU. In a VHT NDP the Data field is not present. The number of symbols in the VHT-LTF field, N_{VHTLTF} , can be either 1, 2, 4, 6, or 8 and is determined by the total number of space-time streams across all users being transmitted in the VHT PPDU (see Table 21-13).

(Source : IEEE 802.11-2016 Standard, p. 2514)

In both HT-mixed format and HT-greenfield format frames, there are two types of HT-LTFs: Data HT-LTFs (HT-DLTFs) and Extension HT-LTFs (HT-ELTFs). HT-DLTFs are always included in HT PPDU to provide the necessary reference for the receiver to form a channel estimate that allows it to demodulate the data

(Source : IEEE 802.11-2016 Standard, p. 2347)

null data packet (NDP): A physical layer (PHY) protocol data unit (PPDU) that carries no Data field.

off-channel: A channel used by a tunneled direct link setup (TDLS) station (STA) that does not overlap the channel(s) used by the access point (AP) with which the TDLS STA is associated.

(Source : IEEE 802.11-2016 Standard, p. 157)

sounding physical layer (PHY) protocol data unit (PPDU): A PPDU that is intended by the transmitting station (STA) to enable the receiving STA to estimate the channel between the transmitting STA and the receiving STA. The Not Sounding field in the High Throughput SIGNAL field (HT-SIG) is equal to 0 in sounding PPDU.

(Source : IEEE 802.11-2016 Standard, p. 163)

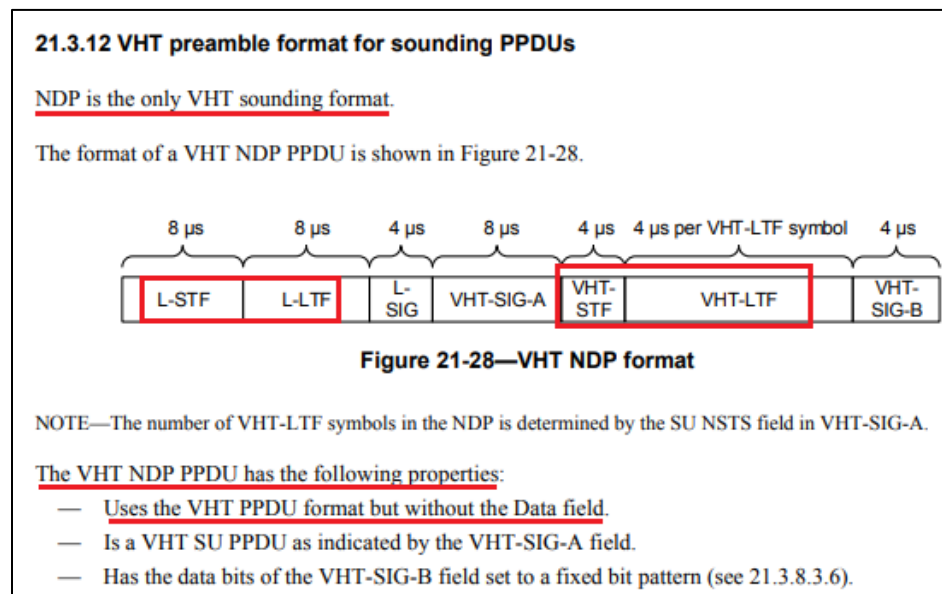

(Source : IEEE 802.11-2016 Standard, p. 2580)

10.34 Null data packet (NDP) sounding

10.34.1 HT NDP sounding protocol

Sounding may be accomplished using either staggered sounding PPDU or HT NDP, as described in 19.3.13. The MAC rules associated with sounding using HT NDP are described in 10.34.1 to 10.34.4.

(Source : IEEE 802.11-2016 Standard, p. 1485)

70. The methods practiced by Legrand's use of the accused products include methods in which a reference signal representing interference in said other time slot is formed and used for the tuning of the receiver in said receiving time slots. For example, the accused products are and have been used by Defendant to implement the IEEE 802.11-2016 Standard, whose requirements were in effect five years before the Complaint. In that Standard, beamforming techniques are and have been used to improve the reception at a receiver STA. These techniques use the channel state information and generate steering matrices for the transmission of data. There are two types of beamforming methods described in the standard, Implicit feedback beamforming and Explicit feedback beamforming. A steering matrix, Q_k , is calculated in both beamforming methods. Explicit feedback beamforming enables a beamformee i.e., receiving STA to calculate beamforming feedback matrix based on the received sounding packets/PPDUs. NDPs can be used as sounding PPDUs and hence, no data/information is received during the beamforming procedures. The Standard shows a scenario wherein STA A (transmit STA) transmits a sounding packet (which can be NDP PDU) that is used by STA B (receiving STA) to calculate a beamforming feedback matrix V_k ("reference signal"). The feedback matrix is later sent to STA A for determining a steering matrix which is used to tune and re-calibrate the receiver STA in order to demodulate the transmitted signal. Implicit feedback beamforming enables STA to estimate a MIMO channel and calculate channel matrices, based on a received sounding PDU. NDPs can be used as sounding PPDUs and hence, no data/information is received during the beamforming procedures. The Standard shows a scenario wherein STA A and STA B (receiving STA) follow beamforming calibration procedures using sounding PPDUs. STA A and STA B will exchange sounding PPDUs (which can be NDP PPDUs), using which each of the STAs will estimate respective channel matrices. Quantized estimates of the channel

matrices (“reference signal”) are sent from STA B to STA A. Later, STA A uses its local estimates and the received quantized estimates from STA B to calculate set of correction matrices. These correction matrices that are formed using the received quantized estimates, are applied at transmit side of a STA to correct/tune the amplitude and phase differences in transmit and receive chains. All the above discussed steps are performed as a part of beamforming calibration procedures using sounding PPDU. The Standard also shows equations for the received signal with beamforming. The channel estimates and beamforming steering matrix are and have been used to tune and re-calibrate the receiver in order to demodulate the transmitted signal.

19.3.12 Beamforming

19.3.12.1 General

Beamforming is a technique in which the beamformer utilizes the knowledge of the MIMO channel to generate a steering matrix Q_k that improves reception in the beamformee.

The equivalent complex baseband MIMO channel model is one in which, when a vector $\mathbf{x}_k = [x_1, x_2, \dots, x_{N_{TX}}]^T$ is transmitted in subcarrier k , the received vector $\mathbf{y}_k = [y_1, y_2, \dots, y_{N_{RX}}]^T$ is modeled as shown in Equation (19-62).

$$\mathbf{y}_k = H_k \mathbf{x}_k + \mathbf{n} \quad (19-62)$$

where

H_k is channel matrix of dimensions $N_{RX} \times N_{TX}$

\mathbf{n} is white (spatially and temporally) Gaussian noise as illustrated in Figure 19-14

(Source : IEEE 802.11-2016 Standard, p. 2392-2393)

When beamforming is used, the beamformer replaces \mathbf{x}_k , which in this case has $N_{STS} \leq N_{TX}$ elements, with $Q_k \mathbf{x}_k$, where Q_k has N_{TX} rows and N_{STS} columns, so that the received vector is as shown in Equation (19-63).

$$\mathbf{y}_k = H_k Q_k \mathbf{x}_k + \mathbf{n} \quad (19-63)$$

The beamforming steering matrix that is computed (or updated) from a new channel measurement replaces the existing Q_k for the next beamformed data transmission. There are several methods of beamforming, differing in the way the beamformer acquires the knowledge of the channel matrices H_k and on whether the beamformer generates Q_k or the beamformee provides feedback information for the beamformer to generate Q_k .

(Source : IEEE 802.11-2016 Standard, p. 2393)

19.3.12.3 Explicit feedback beamforming

19.3.12.3.1 General

In explicit beamforming, in order for STA A to transmit a beamformed packet to STA B, STA B measures the channel matrices and sends STA A either the effective channel, $H_{eff,k}$, or the beamforming feedback matrix, V_k , for STA A to determine a steering matrix, $Q_{steer,k} = Q_k V_k$, with V_k found from $H_k Q_k$, where Q_k is the orthonormal spatial mapping matrix that was used to transmit the sounding packet that elicited the V_k feedback. The effective channel, $H_{eff,k} = H_k Q_k$, is the product of the spatial mapping matrix used on transmit with the channel matrix. When new steering matrix $Q_{steer,k}$ is found, $Q_{steer,k}$ may replace Q_k for the next beamformed data transmission.

NOTE— $Q_{steer,k}$ is a mathematical term to update a new steering matrix for Q_k in the next beamformed data transmission.

(Source : IEEE 802.11-2016 Standard, p. 1477)

10.32.3 Explicit feedback beamforming

The procedures in this subclause apply only to HT and non-HT PPDU for which the HT Control field, if present, is the HT variant HT Control field.

In this subclause, the terms *HT beamformer* and *HT beamformee* refer to STAs that are involved in explicit feedback beamforming.

An HT beamformer uses the feedback response that it receives from the HT beamformee to calculate a beamforming feedback matrix for transmit beamforming. This feedback response may have one of three formats:

- *CSI*: The HT beamformee sends the MIMO channel coefficients to the HT beamformer.
- *Noncompressed beamforming*: The HT beamformee sends calculated beamforming feedback matrices to the HT beamformer.
- *Compressed beamforming*: The HT beamformee sends compressed beamforming feedback matrices to the HT beamformer.

(Source : IEEE 802.11-2016 Standard, p. 1477)

10.34 Null data packet (NDP) sounding**10.34.1 HT NDP sounding protocol**

Sounding may be accomplished using either staggered sounding PPDU or HT NDP, as described in 19.3.13. The MAC rules associated with sounding using HT NDP are described in 10.34.1 to 10.34.4.

(Source : IEEE 802.11-2016 Standard, p. 1477)

10.34.5 VHT sounding protocol**10.34.5.1 General**

Transmit beamforming and DL-MU-MIMO require knowledge of the channel state to compute a steering matrix that is applied to the transmitted signal to optimize reception at one or more receivers. The STA transmitting using the steering matrix is called the *VHT beamformer*, and a STA for which reception is optimized is called a *VHT beamformee*. An explicit feedback mechanism is used where the VHT beamformee directly measures the channel from the training symbols transmitted by the VHT beamformer and sends back a transformed estimate of the channel state to the VHT beamformer. The VHT beamformer then uses this estimate, perhaps combining estimates from multiple VHT beamformees, to derive the steering matrix.

(Source : IEEE 802.11-2016 Standard, p. 1477)

21.3.12 VHT preamble format for sounding PPDU

NDP is the only VHT sounding format.

The format of a VHT NDP PPDU is shown in Figure 21-28.

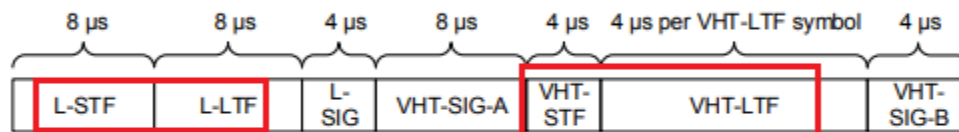

Figure 21-28—VHT NDP format

NOTE—The number of VHT-LTF symbols in the NDP is determined by the SU NSTS field in VHT-SIG-A.

The VHT NDP PPDU has the following properties:

- Uses the VHT PPDU format but without the Data field.
- Is a VHT SU PPDU as indicated by the VHT-SIG-A field.
- Has the data bits of the VHT-SIG-B field set to a fixed bit pattern (see 21.3.8.3.6).

(Source : IEEE 802.11-2016 Standard, p. 2580)

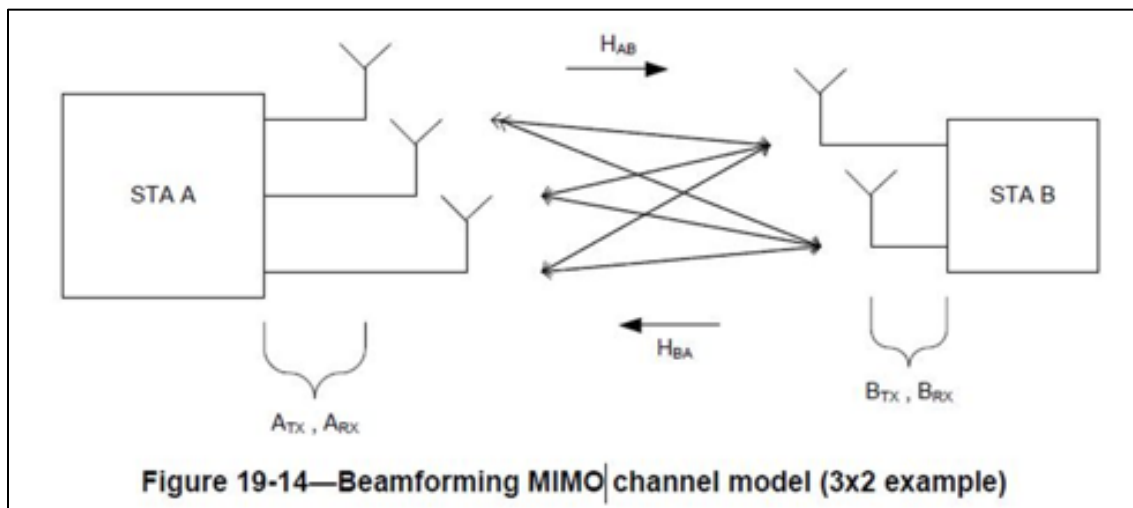

Figure 19-14—Beamforming MIMO channel model (3x2 example)

(Source : IEEE 802.11-2016 Standard, p. 2393)

Focusing on STA A, the procedure for estimating $K_{A,k}$ is as follows:

- a) STA A sends STA B a sounding PPDU, the reception of which allows STA B to estimate the channel matrices $\tilde{H}_{AB,k}$.
- b) STA B sends STA A a sounding PPDU, the reception of which allows STA A to estimate the channel matrices $\tilde{H}_{BA,k}$.
- c) STA B sends the quantized estimates of $\tilde{H}_{AB,k}$ to STA A.
- d) STA A uses its local estimates of $\tilde{H}_{BA,k}$ and the quantized estimates of $\tilde{H}_{AB,k}$ received from STA B to compute the correction matrices $K_{A,k}$.

(Source : IEEE 802.11-2016 Standard, p. 2395)

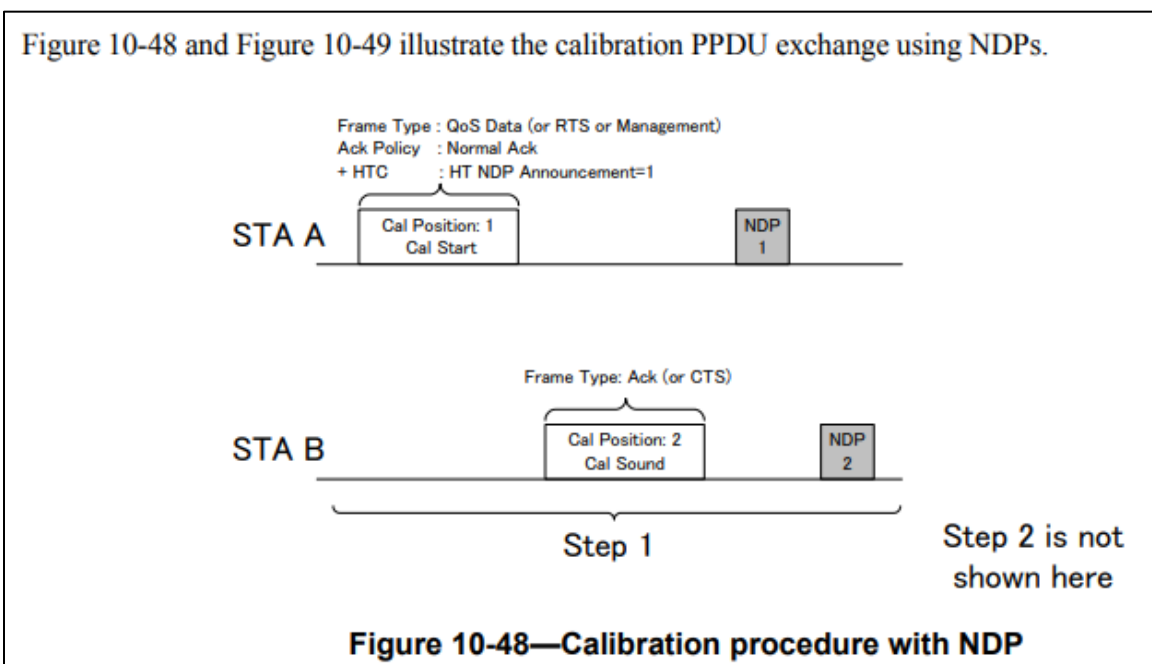

(Source : IEEE 802.11-2016 Standard, p. 1475)

21.3.12 VHT preamble format for sounding PPDU

NDP is the only VHT sounding format.

The format of a VHT NDP PPDU is shown in Figure 21-28.

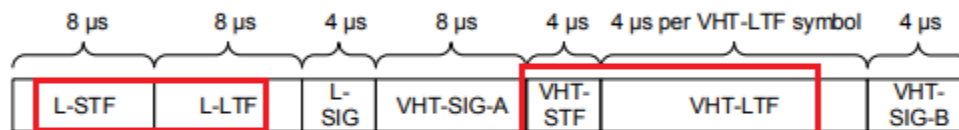

Figure 21-28—VHT NDP format

NOTE—The number of VHT-LTF symbols in the NDP is determined by the SU NSTS field in VHT-SIG-A.

The VHT NDP PPDU has the following properties:

- Uses the VHT PPDU format but without the Data field.
- Is a VHT SU PPDU as indicated by the VHT-SIG-A field.
- Has the data bits of the VHT-SIG-B field set to a fixed bit pattern (see 21.3.8.3.6).

(Source : IEEE 802.11-2016 Standard, p. 2580)

While the over-the-air channel between the antenna(s) at one STA and the antenna(s) at a second STA is reciprocal, the observed baseband-to-baseband channel used for communication might not be, as it includes the transmit and receive chains of the STAs. Differences in the amplitude and phase characteristics of the transmit and receive chains associated with individual antennas degrade the reciprocity of the over-the-air channel and cause degradation of performance of implicit beamforming techniques. The over-the-air calibration procedure described in 10.32.2.4 may be used to restore reciprocity. The procedure provides the means for calculating a set of correction matrices that can be applied at the transmit side of a STA to correct the amplitude and phase differences between the transmit and receive chains in the STA. If this correction is done at least at the STA that serves as the beamformer, there is sufficient reciprocity for implicit feedback in the baseband-to-baseband response of the forward link and reverse channel.

(Source : IEEE 802.11-2016 Standard, p. 2394)

19.3.13.3 Sounding PPDU for calibration

In the case of a bidirectional calibration exchange, two STAs exchange sounding PPDU, the exchange of which enables the receiving STA to compute an estimate of the MIMO channel matrix H_k for each subcarrier k . In general, in an exchange of calibration messages, the number of spatial streams is less than the number of transmit antennas. In such cases, HT-ELTFs are used. In the case of sounding PPDU for calibration, the antenna mapping matrix shall be as shown in Equation (19-86).

(Source : IEEE 802.11-2016 Standard, p. 2401)

Two preamble formats are defined. For HT-mixed format operation, the preamble has a non-HT portion and an HT portion. The non-HT portion of the HT-mixed format preamble enables detection of the PPDU and acquisition of carrier frequency and timing by both HT STAs and STAs that are compliant with Clause 17 and/or Clause 18. The non-HT portion of the HT-mixed format preamble also consists of the SIGNAL field defined in Clause 17 and is thus decodable by STAs compliant with Clause 17 and Clause 18 as well as HT STAs.

The HT portion of the HT-mixed format preamble enables estimation of the MIMO channel to support demodulation of the HT data by HT STAs. The HT portion of the HT-mixed format preamble also includes the HT-SIG field, which supports HT operation. The SERVICE field is prepended to the PSDU.

(Source : IEEE 802.11-2016 Standard, p. 2346)

19.3.12 Beamforming

19.3.12.1 General

Beamforming is a technique in which the beamformer utilizes the knowledge of the MIMO channel to generate a steering matrix Q_k that improves reception in the beamformee.

The equivalent complex baseband MIMO channel model is one in which, when a vector $\mathbf{x}_k = [x_1, x_2, \dots, x_{N_{TX}}]^T$ is transmitted in subcarrier k , the received vector $\mathbf{y}_k = [y_1, y_2, \dots, y_{N_{RX}}]^T$ is modeled as shown in Equation (19-62).

$$\mathbf{y}_k = H_k \mathbf{x}_k + \mathbf{n} \quad (19-62)$$

where

H_k is channel matrix of dimensions $N_{RX} \times N_{TX}$

\mathbf{n} is white (spatially and temporally) Gaussian noise as illustrated in Figure 19-14

(Source : IEEE 802.11-2016 Standard, p. 2392-2393)

When beamforming is used, the beamformer replaces \mathbf{x}_k , which in this case has $N_{STS} \leq N_{TX}$ elements, with $Q_k \mathbf{x}_k$, where Q_k has N_{TX} rows and N_{STS} columns, so that the received vector is as shown in Equation (19-63).

$$\mathbf{y}_k = H_k Q_k \mathbf{x}_k + \mathbf{n} \quad (19-63)$$

The beamforming steering matrix that is computed (or updated) from a new channel measurement replaces the existing Q_k for the next beamformed data transmission. There are several methods of beamforming, differing in the way the beamformer acquires the knowledge of the channel matrices H_k and on whether the beamformer generates Q_k or the beamformee provides feedback information for the beamformer to generate Q_k .

(Source : IEEE 802.11-2016 Standard, p. 2393)

71. American Patents only asserts method claims from the '803 Patent.

72. American Patents has been damaged as a result of the infringing conduct by Legrand alleged above. Thus, Legrand is liable to American Patents in an amount that adequately compensates it for such infringements, which, by law, cannot be less than a reasonable royalty, together with interest and costs as fixed by this Court under 35 U.S.C. § 284.

ADDITIONAL ALLEGATIONS REGARDING INFRINGEMENT

73. In addition to any specific products mentioned above, the accused products also include at least the following products: Legrand DA1101, Legrand DA1104NP, Legrand Luxul WS-250 Series, Legrand XAP-1010 Seies, Legrand XAP-1020 Series, Legrand XAP-103X Series, Legrand XAP-1040 Series, Legrand XAP-1210 Series, Legrand XAP-1230 Series, Legrand XAP-1240 Series, Legrand XAP-1410 Series, Legrand XAP-1440 Series, Legrand XAP-1500 Series, Legrand XAP-1510 Series, Legrand XAP-1610 Series , Legrand XAP-310 Series, Legrand XAP-810 Series , Legrand XWO-BAP1 Series, Legrand NVGW100NA, Legrand CM7100, Legrand MK-10 Series, Legrand MN-10 Series , Legrand Nuvo NVP300 Player Preamplifier, Legrand NVP100NA, Legrand NVP200NA, Legrand NVP3500NA,

Legrand NVP400NA, Legrand P40 Series (AC1200), Legrand XVWP30, Legrand CU282, Legrand DA2131-V1, Legrand DA2154-V1, Legrand DA2155-V1, Legrand Luxul WS-250 (AC3100 Router), Legrand WS-80 Series, Legrand XWR-1200 Series, Legrand XWR-1750 Series, Legrand XWR-3150 Series, Legrand XWR-600 Series, Legrand LC2201LA, Legrand LC2201NI, Legrand LC2201WH, Legrand LC2203LA, Legrand LC2203NI, Legrand LC2203WH, Legrand LC2303LA, Legrand LC2303NI, Legrand LC2303WH, Legrand LC7500WH, Legrand MR232G, Legrand MRR2G, Legrand NDB01, Legrand NHC01, Legrand NOC01, Legrand NSC01, Legrand NWS02IN, Legrand NWS03IN, Legrand OTP02, Legrand TPG01, Legrand TPG02, Legrand WNRH1, Legrand WWP20, Legrand WWRL10, Legrand WZ3TSATH, Legrand ADMHRM4, Legrand ADTH600RMHW1, Legrand ADTH700RMTUG1, Legrand ADTH700RMTUW1, Legrand ADTHRIWHCG1, Legrand ADTHRRG1, Legrand ADTHRRW1, Legrand ADTP600RMHM1, Legrand ADTP600RMHW1, Legrand ADTP700RMTUG1, Legrand ADTP700RMTUM1, Legrand ADTPMRUW2, Legrand ADTPRIWHCG1, Legrand ADTPRIWHCW1, Legrand ADTPRRG1, Legrand ADTPRRW1, Legrand ADWHRM4, Legrand ADWR600RMHW1, Legrand ADWR700RMTUG1, Legrand ADWR700RMTUW1, Legrand ADWRMRUM2, Legrand ADWRRRG1, Legrand ADWRRRW1, Legrand ARPS15RF2W4, Legrand ASTH155RMG1, Legrand ASTH155RMW1, Legrand ASTHRRG1, Legrand ASTHRRM1, Legrand ASTP155RMG1, Legrand ASTP155RMW1, Legrand ASTPRFR2M2, Legrand ASTPRRG1, Legrand ASTPRRW1, Legrand ASWR155RMG1, Legrand ASWR155RMM1, Legrand ASWRRRM1, Legrand ASWRRRW1, Legrand HKRP10, Legrand HKRP20, Legrand HKT1, Legrand KTWIFI1, Legrand SA7522, Legrand WWP10CCV2, Legrand WWP20CCV2, Legrand WWP30CCV2, Legrand WWRL10WHCCV2, Legrand WWRL50WHCCV2, Legrand WWRR15WHCCV2,

Legrand MS6521V1- airQast Wi-Fi speaker system, Legrand PCBA-200010-01, Legrand 203015, Legrand HA7040, Legrand XWS-1810, Legrand XWS-2510 Series , and Legrand XWS-2610 Series.

74. Legrand has also indirectly infringed the ‘782 Patent, the ‘304 Patent, and the ‘458 Patent by inducing others to directly infringe the ‘782 Patent, the ‘304 Patent, and the ‘458 Patent. Legrand has induced the end-users, Legrand’s customers, to directly infringe (literally and/or under the doctrine of equivalents) the ‘782 Patent, the ‘304 Patent, and the ‘458 Patent by using the accused products.

75. Legrand took active steps, directly and/or through contractual relationships with others, with the specific intent to cause them to use the accused products in a manner that infringes one or more claims of the patents-in-suit, including, for example, Claim 30 of the ‘782 Patent, Claim 1 of the ‘304 Patent, and Claim 1 of the ‘458 Patent.

76. Such steps by Legrand included, among other things, advising or directing customers and end-users to use the accused products in an infringing manner; advertising and promoting the use of the accused products in an infringing manner; and/or distributing instructions that guide users to use the accused products in an infringing manner.

77. Legrand has performed these steps, which constitute induced infringement, with the knowledge of the ‘782 Patent, the ‘304 Patent, and the ‘458 Patent and with the knowledge that the induced acts constitute infringement.

78. Legrand was and is aware that the normal and customary use of the accused products by Legrand’s customers would infringe the ‘782 Patent, the ‘304 Patent, and the ‘458 Patent. Legrand’s inducement is ongoing.

79. Legrand has also induced its affiliates, or third-party manufacturers, shippers, distributors, retailers, or other persons acting on its or its affiliates' behalf, to directly infringe (literally and/or under the doctrine of equivalents) the '782 Patent, the '304 Patent, and the '458 Patent by importing, selling, offering to sell, and/or using the accused products.

80. Legrand has at least a significant role in placing the accused products in the stream of commerce in Texas and elsewhere in the United States.

81. Legrand directs or controls the making of accused products and their shipment to the United States, using established distribution channels, for sale in Texas and elsewhere within the United States.

82. Legrand directs or controls the sale of the accused products into established United States distribution channels, including sales to nationwide retailers.

83. Legrand's established United States distribution channels include one or more United States based affiliates (*e.g.*, at least Legrand Home Systems, Pass & Seymour, and The Watt Stopper, Inc.).

84. Legrand directs or controls the sale of the accused products nationwide on its own websites as well as in nationwide retailers such as Amazon, Lowe's, and The Home Depot, including for sale in Texas and elsewhere in the United States, and expects and intends that the accused products will be so sold.

85. Legrand took active steps, directly and/or through contractual relationships with others, with the specific intent to cause such persons to import, sell, or offer to sell the accused products in a manner that infringes one or more claims of the patents-in-suit, including, for example, Claim 30 of the '782 Patent, Claim 1 of the '304 Patent, and Claim 1 of the '458 Patent.

86. Such steps by Legrand included, among other things, making or selling the accused products outside of the United States for importation into or sale in the United States, or knowing that such importation or sale would occur; and directing, facilitating, or influencing its affiliates, or third-party manufacturers, shippers, distributors, retailers, or other persons acting on its or their behalf, to import, sell, or offer to sell the accused products in an infringing manner.

87. Legrand performed these steps, which constitute induced infringement, with the knowledge of the '782 Patent, the '304 Patent, and the '458 Patent and with the knowledge that the induced acts would constitute infringement.

88. Legrand performed such steps in order to profit from the eventual sale of the accused products in the United States.

89. Legrand's inducement is ongoing.

90. Legrand has also indirectly infringed by contributing to the infringement of the '782 Patent, the '304 Patent, and the '458 Patent. Legrand has contributed to the direct infringement of the '782 Patent, the '304 Patent, and the '458 Patent by the end-user of the accused products.

91. The accused products have special features that are specially designed to be used in an infringing way and that have no substantial uses other than ones that infringe the '782 Patent, the '304 Patent, and the '458 Patent, including, for example, Claim 30 of the '782 Patent, Claim 1 of the '304 Patent, and Claim 1 of the '458 Patent.

92. As described above, the special features include improved wireless communication capabilities used in a manner that infringes the '782 Patent, the '304 Patent, and the '458 Patent.

93. The special features constitute a material part of the invention of one or more of the claims of the '782 Patent, the '304 Patent, and the '458 Patent and are not staple articles of commerce suitable for substantial non-infringing use.

94. Legrand's contributory infringement is ongoing.

95. Furthermore, Legrand has a policy or practice of not reviewing the patents of others (including instructing its employees to not review the patents of others), and thus has been willfully blind of American Patents' patent rights. *See, e.g.*, M. Lemley, "Ignoring Patents," 2008 Mich. St. L. Rev. 19 (2008).

96. Legrand's actions are at least objectively reckless as to the risk of infringing valid patents and this objective risk was either known or should have been known by Legrand.

97. Legrand has knowledge of the '782 Patent, the '304 Patent, and the '458 Patent.

98. Legrand's customers have infringed the '782 Patent, the '304 Patent, and the '458 Patent.

99. Legrand encouraged its customers' infringement.

100. Legrand's direct and indirect infringement of the '782 Patent, the '304 Patent, and the '458 Patent is, has been, and/or continues to be willful, intentional, deliberate, and/or in conscious disregard of American Patents' rights under the patents.

101. American Patents has been damaged as a result of the infringing conduct by Legrand alleged above. Thus, Legrand is liable to American Patents in an amount that adequately compensates it for such infringements, which, by law, cannot be less than a reasonable royalty, together with interest and costs as fixed by this Court under 35 U.S.C. § 284.

CLARIFICATION REGARDING PATENT EXPIRATION

102. For the avoidance of doubt, American Patents does not seek relief under any asserted patent for acts occurring after the expiration of that patent.

JURY DEMAND

American Patents hereby requests a trial by jury on all issues so triable by right.

PRAYER FOR RELIEF

American Patents requests that the Court find in its favor and against Legrand, and that the Court grant American Patents the following relief:

- a. Judgment that one or more claims of the '782 Patent, the '304 Patent, the '458 Patent, and the '803 Patent have been infringed, either literally and/or under the doctrine of equivalents, by Legrand and/or all others acting in concert therewith;
- b. A permanent injunction enjoining Legrand and its officers, directors, agents, servants, affiliates, employees, divisions, branches, subsidiaries, parents, and all others acting in concert therewith from infringement of the '782 Patent, the '304 Patent, and the '458 Patent; or, in the alternative, an award of a reasonable ongoing royalty for future infringement of the '782 Patent, the '304 Patent, and the '458 Patent by such entities;
- c. Judgment that Legrand account for and pay to American Patents all damages to and costs incurred by American Patents because of Legrand's infringing activities and other conduct complained of herein, including an award of all increased damages to which American Patents is entitled under 35 U.S.C. § 284;
- d. That American Patents be granted pre-judgment and post-judgment interest on the damages caused by Legrand's infringing activities and other conduct complained of herein;
- e. That this Court declare this an exceptional case and award American Patents its reasonable attorney's fees and costs in accordance with 35 U.S.C. § 285; and

f. That American Patents be granted such other and further relief as the Court may deem just and proper under the circumstances.

Dated: December 21, 2021

Respectfully submitted,

/s/ Zachariah S. Harrington

Matthew J. Antonelli

Texas Bar No. 24068432

matt@ahtlawfirm.com

Zachariah S. Harrington

Texas Bar No. 24057886

zac@ahtlawfirm.com

Larry D. Thompson, Jr.

Texas Bar No. 24051428

larry@ahtlawfirm.com

Christopher Ryan Pinckney

Texas Bar No. 24067819

ryan@ahtlawfirm.com

ANTONELLI, HARRINGTON

& THOMPSON LLP

4306 Yoakum Blvd., Ste. 450

Houston, TX 77006

(713) 581-3000

Stafford Davis

State Bar No. 24054605

sdavis@stafforddavisfirm.com

Catherine Bartles

Texas Bar No. 24104849

cbartles@stafforddavisfirm.com

THE STAFFORD DAVIS FIRM

815 South Broadway Avenue

Tyler, Texas 75701

(903) 593-7000

(903) 705-7369 fax

Attorneys for American Patents LLC