

**IN THE UNITED STATES DISTRICT COURT
EASTERN DISTRICT OF MICHIGAN
SOUTHERN DIVISION**

BEACON NAVIGATION GMBH,

Plaintiff,

v.

KIA MOTORS CORP.; KIA
MOTORS AMERICA, INC.; AND
KIA MOTORS
MANUFACTURING GEORGIA,
INC.,

Defendants.

Civil Case No. 13-cv-11441-MAG-EAS

Hon. Mark A. Goldsmith
Mag. Elizabeth A. Stafford

JURY TRIAL DEMANDED

FIRST AMENDED COMPLAINT

Plaintiff Beacon Navigation GmbH (“Beacon” or “Plaintiff”), for its Complaint against Defendants Kia Motors Corp. (“Kia Motors”), Kia Motors America, Inc. (“Kia America”), and Kia Motors Manufacturing Georgia, Inc. (“Kia Georgia”) (collectively “Kia”) states and alleges as follows:

THE PARTIES

1. Plaintiff Beacon is a Swiss company with limited liability with a principal place of business at Innere Güterstrasse 4, 6304 Zug, Switzerland.
2. Upon information and belief, Defendant Kia Motors Corp. is a Korean corporation with its principal place of business at 12 Heolleung-ro, Seocho-gu,

Seoul 137-938 South Korea.

3. Upon information and belief, Defendant Kia Motors America is a California corporation with its principal place of business at 111 Peters Canyon Rd., Irvine, CA 92606.

4. Upon information and belief, Defendant Kia Motors Manufacturing Georgia is a Delaware Corporation with its principal place of business at 7777 Kia Parkway, West Point, Georgia 31833.

JURISDICTION AND VENUE

5. This action arises under the patent laws of the United States, 35 U.S.C. § 1 *et seq.*, including 35 U.S.C. § 271. This Court has subject matter jurisdiction pursuant to 28 U.S.C. §§ 1331 and 1338(a).

6. This Court has personal jurisdiction over the Kia Defendants because, directly or through intermediaries, each has committed acts within the Eastern District of Michigan giving rise to this action and/or has established minimum contacts with the Eastern District of Michigan such that the exercise of jurisdiction would not offend traditional notions of fair play and substantial justice.

7. The Kia Defendants have placed or contributed to placing infringing products into the stream of commerce via an established distribution channel knowing or understanding that such products would be sold and used in the United States, including in the Eastern District of Michigan.

8. The Court has personal jurisdiction over the Kia Defendants because they affirmatively sought and obtained transfer of this action from the United States District Court for the District of Delaware to this Court.

9. Venue is proper in this District pursuant to 28 U.S.C. §§ 1391(b), 1391(c), 1391(d) and/or 1400(b) because Kia Motors is a foreign corporation and personal jurisdiction exists over Kia Motors as set forth above. Venue is proper in this District for Kia America and Kia Georgia because they affirmatively sought and obtained transfer of this action from the United States District Court for the District of Delaware to this Court.

BACKGROUND

10. Beacon owns all right, title, and interest in U.S. Patent No. 5,862,511 (the “’511 patent”).

11. The ’511 patent, entitled “Vehicle Navigation System and Method,” was duly and legally issued by the United States Patent and Trademark Office on January 19, 1999, after full and fair examination. A copy of the ’511 patent is attached hereto as Exhibit A.

12. The ’511 patent was the subject of multiple re-examinations before the United States Patent and Trademark Office, and reexamination certificates confirming the patentability of claims 1 and 3 were issued on: September 25, 2012 (Number US 5,862,511 C1); June 27, 2014 (Number US 5,862,511 C2); November

23, 2016 (Number US 5,862,511 C3); and October 12, 2021 (Number US 5,862,511 C4).

13. Kia Motors Corp., Kia America, and Kia Georgia manufacture, sell and distribute vehicles with navigation systems that infringe claims 1 and 3 of the '511 Patent.

COUNT I

INFRINGEMENT OF THE '511 PATENT

14. Beacon incorporates each of the preceding paragraphs 1-13 as if fully set forth herein.

15. Kia Motors, Kia America, and Kia Georgia have been and are infringing literally and/or under the doctrine of equivalents, directly, contributorily, or by inducement, claims 1 and 3 of the '511 patent.

16. Kia Motors., Kia America, and Kia Georgia directly infringe claim 1 of the '511 Patent, in violation of 35 U.S.C. § 271(a), by making, using, selling, offering for sale, and/or importing in or into the United States, without authority, vehicles with navigation systems. Upon information and belief, this infringement includes the manufacture, use, sale, offer for sale and importation of at least the following car models sold by Kia in the United States prior to the expiration of the '511 Patent on December 28, 2015, including, but not limited to: Cadenza; Forte; K900; Optima; Sedona; Sorento; Soul; and Sportage.

17. Upon information and belief, the Kia defendants directly infringe claim 1 of the '511 Patent.

18. The Kia defendants manufacture, import, and sell cars that contain a GPS navigation system. For example, the 2011 Kia Sportage was sold in the United States with a GPS navigation system.

19. The navigation system contained in the Kia accused products includes a map database with map information. The navigation system derives a map heading from the map information. This was shown, for example, in the 2011 Kia Sportage because when a route is programmed, the entire route is highlighted, which serves as an indication of the heading along that mapped path. This was further shown in the Kia Sportage by a test in which a route was programmed into the navigation system, the car diverged from the route, and the car cursor followed the programmed route for a short duration regardless of the fact that the car was not in fact on the route. During that time, the navigation system was using the map heading rather than the GPS receiver's heading.

20. Upon information and belief, the navigation system in the Kia accused products provides GPS velocity information, including a heading. GPS receivers provide both position and velocity information. The Kia Sportage was tested where the car was traveling at a high velocity on a freeway. The car position was updated much more frequently than once per second, the typical refresh rate of

GPS position information. On information and belief, this demonstrates that the position of the car was propagated based on GPS velocity information rather than waiting for the next time the GPS receiver updated its position. On information and belief, GPS receivers produce information sufficient to determine position each update period (which is typically once a second), whereas velocity may be used to propagate position more frequently, and with more accuracy, than using GPS position information each update period. Therefore, the system uses velocity information to propagate a previous position to a current position.

21. Upon information and belief, the Kia navigation system updates the velocity heading with the map information for propagating the previous position to a current position, where the difference between the heading of the velocity information and the map heading are within a threshold, where the system rotates the velocity vector to align with the map heading and integrates the rotated velocity to obtain a displacement and then applying this to the previous position. Upon information and belief, this was shown by a test in which a route was programmed into the navigation system. The car navigation system obtains a map heading from the map database. When the car left the planned route, by exiting the freeway, the cursor showing the position of the car initially followed a map heading, even though the car had left the freeway. While the GPS receiver determined heading and the map heading were within a threshold, the car cursor continued to follow

the programmed route. When the car had sufficiently diverged from the route by an amount that exceeded the threshold, the cursor showing the position of the car moved to the actual location of the car. Upon information and belief, during the period of time that the difference between the GPS receiver determined heading and the map heading was within a threshold, the GPS receiver determined heading was aligned with the map heading, as shown by the fact that the cursor continued to follow the plotted route. Upon information and belief, the velocity vector was rotated to align with the map heading. During the test in which the car was traveling at a high velocity, position was updated more frequently than once a second. Therefore, upon information and belief, the rotated velocity vector was used to provide car displacements by integrating the velocity to obtain a displacement, and then adding the displacement to the car's previous position to obtain a current position.

22. Upon information and belief, Kia Motors Corp., Kia Motors America, and Kia Motors Georgia had knowledge of the '511 patent based on a letter sent to each of them on September 28, 2011, by the filing of the ITC complaint in Investigation No. 337-TA-814, and by the filing off the initial Complaint in this action.

23. Upon information and belief, Kia Motors Corp., Kia Motors America, and Kia Motors Manufacturing Georgia actively induce others (e.g., consumers) to

directly infringe claims 1 and 3 of the '511 patent, in violation of 35 U.S.C. § 271(b), by providing products with GPS navigation systems, including but not limited to vehicles with navigation, along with instructions, user manuals, or technical assistance actively directing, encouraging or assisting infringement of the '511 patent.

24. When they follow Kia's instructions to use the GPS navigation system, the Kia Defendant's customers practice the method of claim 3 of the '511 patent, and directly infringe that claim.

25. The Kia defendants manufacture, import, and sell cars that contain a GPS navigation system. For example, the 2011 Kia Sportage was sold in the United States with a GPS navigation system. Upon information and belief, when used, these navigation systems can estimate the velocity of a car known to be on a mapped path.

26. Upon information and belief, the navigation system in the Kia accused products provides velocity information, including a heading. GPS receivers provide both position and velocity information. The Kia Sportage was tested where the car was traveling at a high velocity on a freeway. The car position was updated much more frequently than once per second, the typical refresh rate of GPS position information. On information and belief, this demonstrates that the position of the car was propagated based on GPS velocity information rather than

waiting for the next time the GPS receiver updated its position. On information and belief, GPS receivers produce information sufficient to determine position each update period (which is typically once a second), whereas velocity may be used to propagate position more frequently, and with more accuracy, than using GPS position information each update period.

27. Upon information and belief, the navigation system contained in the Kia accused products includes a map database with map information. The navigation system derives a map heading from the map information. This is shown, for example, in the 2011 Kia Sportage because when a route is programmed, the entire route is highlighted, which serves as an indication of the heading along that mapped path.

28. Upon information and belief, the Kia accused products update the velocity with the map heading when the difference between the heading of the velocity and the map heading are within a threshold. Upon information and belief, this was shown by a test in which a route was programmed into the navigation system. The car navigation system obtains a map heading from the map database. When the car left the planned route, by exiting the freeway, the cursor showing the position of the car initially followed a map heading, even though the car had left the freeway. While the GPS receiver determined heading and the map heading were within a threshold, the car cursor continued to follow the programmed route.

When the car had sufficiently diverged from the route by an amount that exceeded the threshold, the cursor showing the position of the car moved to the actual location of the car. Upon information and belief, during the period of time that the difference between the GPS receiver determined heading and the map heading was within a threshold, the GPS receiver determined heading was aligned with the map heading, as shown by the fact that the cursor continued to follow the plotted route.

29. Upon information and belief, the accused Kia products use the velocity to propagate a previous position to a current position, by rotating the velocity to align with the map heading and integrating the rotated velocity to obtain a displacement, and then applying the displacement to a previous position. Upon information and belief, this was shown by a test in which a route was programmed into the navigation system. The car navigation system obtains a map heading from the map database. When the car left the planned route, by exiting the freeway, the cursor showing the position of the car initially followed a map heading, even though the car had left the freeway. While the GPS receiver determined heading and the map heading were within a threshold, the car cursor continued to follow the programmed route. When the car had sufficiently diverged from the route by an amount that exceeded the threshold, the cursor showing the position of the car moved to the actual location of the car. Upon information and belief, during the period of time that the difference between the GPS receiver determined heading

and the map heading was within a threshold, the GPS receiver determined heading was aligned with the map heading, as shown by the fact that the cursor continued to follow the plotted route. Upon information and belief, the velocity vector was rotated to align with the map heading. During the test in which the car was traveling at a high velocity, position was updated more frequently than once a second. Therefore, upon information and belief, the rotated velocity vector was used to provide car displacements by integrating the velocity to obtain a displacement, and then adding the displacement to the car's previous position to obtain a current position.

30. As a direct and proximate result of the acts of patent infringement by Kia Motors Corp., Kia Motors America, and Kia Motors Manufacturing Georgia, Beacon has been damaged in an amount not presently known for infringing acts that occurred at least between the date of notice and the expiration of the '511 Patent on December 28, 2015.

31. Beacon has incurred and will incur attorneys' fees, costs, and expenses in the prosecution of this action. The circumstances of this dispute create an exceptional case within the meaning of 35 U.S.C. § 285, and Beacon is entitled to recover its reasonable and necessary fees and expenses.

PRAYER FOR RELIEF

Beacon requests that judgment be entered in its favor and against Kia Motors Corp., Kia Motors America, and Kia Motors Manufacturing Georgia, and that the Court award the following relief to Beacon:

- (a) damages in an amount adequate to compensate Beacon for infringement of the patents-in-suit, and in no event less than a reasonable royalty;
- (b) expenses, costs, and reasonable attorneys' fees pursuant to 35 U.S.C. § 285;
- (c) prejudgment and post-judgment interest on all damages; and
- (d) such other relief as the Court deems just and proper.

JURY DEMAND

In accordance with Federal Rules of Civil Procedure 38 and 39, Beacon asserts its rights under the Seventh Amendment to the United States Constitution and demands a trial by jury on all issues triable by a jury.

Dated: November 18, 2022

Respectfully submitted,

/s/ Craig Kaufman

Jay M. Schloff (SBN P60183)
AIDENBAUM SCHLOFF AND BLOOM
PLLC
6960 Orchard Lake Road, Suite 250
West Bloomfield, Michigan 48322
Telephone: (248) 865-6500
jschloff@aidenbaum.com

Craig Kaufman (admitted in E.D. Michigan)
TECHKNOWLEDGE LAW GROUP LLP
20660 Stevens Creek Blvd., Suite 381
Cupertino, CA 95014
(650) 517-5200
ckaufman@tklg-llp.com

Counsel for Plaintiff
BEACON NAVIGATION GMBH

Exhibit A



US005862511A

United States Patent [19]
Croyle et al.

[11] **Patent Number:** **5,862,511**
 [45] **Date of Patent:** **Jan. 19, 1999**

[54] **VEHICLE NAVIGATION SYSTEM AND METHOD**

[75] Inventors: **Steven R. Croyle**, Franklin; **Larry E. Spencer, II**, Lake Orion; **Ernie R. Sittaro**, Romeo, all of Mich.

[73] Assignee: **Magellan DIS, Inc.**, Rochester Hills, Mich.

[21] Appl. No.: **580,150**

[22] Filed: **Dec. 28, 1995**

[51] **Int. Cl.⁶** **G06G 7/48**

[52] **U.S. Cl.** **701/213; 701/214; 701/215; 701/208; 73/178 R**

[58] **Field of Search** 364/460, 461, 364/444.1, 449.1, 450, 447, 449.7, 449.3, 454, 453, 448, 440, 443; 340/988, 990, 995; 73/178 R; 342/357, 457, 352, 451; 701/207, 208, 213, 214, 215, 221, 220, 216

[56] **References Cited**

U.S. PATENT DOCUMENTS

3,749,893	7/1973	Hileman	235/150.27
3,789,198	1/1974	Henson et al.	235/150.27
3,845,289	10/1974	French	235/151.2
3,984,806	10/1976	Tyler	340/23
4,032,758	6/1977	Lewis	235/150.2
4,086,632	4/1978	Lions	364/444
4,107,689	8/1978	Jellinek	343/112 TC

(List continued on next page.)

FOREIGN PATENT DOCUMENTS

0 059 435	9/1982	European Pat. Off. .
0 061 564 1	10/1982	European Pat. Off. .
0 069 965	1/1983	European Pat. Off. .
0 103 847	3/1984	European Pat. Off. .
0 110 171	6/1984	European Pat. Off. .
0 118 886	9/1984	European Pat. Off. .
0 181 012	5/1986	European Pat. Off. .
0 471 405	2/1992	European Pat. Off. .

(List continued on next page.)

OTHER PUBLICATIONS

Integration of GPS and Dead Reckoning Navigation Systems by Wei-Wen Kao published Jan. 10, 1991 in the Institute of Electrical and Electronics Engineers.
 Brochure: Fleet-Trak: Fleet Management System.
 McLellan, et al., Application of GPS Positioning to Management of Mobile Operations, pp. 1-16; 1991.
 Stanley K. Honey; A Novel Approach to Automotive Navigation and Map Display, pp. 40-43.
 Siemens, Ali-Scout System;
 G. C. Larson; Evaluation of an AVM System Implemented City-Wide in St. Louis, pp. 378-383.
 Brochure: NavTrax 1000 Fleet Management System.

(List continued on next page.)

Primary Examiner—Jacques H. Louis-Jacques
Attorney, Agent, or Firm—Howard & Howard

[57] **ABSTRACT**

The improved vehicle navigation system and method uses information from a Global Positioning System (GPS) to obtain velocity vectors, which include speed and heading components, for "dead reckoning" the vehicle position from a previous position. If information from the GPS is not available, then the improved vehicle navigation system uses information from an orthogonal axes accelerometer, such as two or three orthogonally positioned accelerometers, to propagate vehicle position. Because the GPS information should almost always be available, the improved vehicle navigation system relies less on its accelerometers, thereby allowing the use of less expensive accelerometers. The improved vehicle navigation system retains the accuracy of the accelerometers by repeatedly calibrating them with the velocity data obtained from the GPS information. The improved vehicle navigation system calibrates the sensors whenever GPS data is available (for example, once a second at relatively high speeds). Furthermore, the improved vehicle navigation system does not need to rely on map matching to calibrate sensors. System flexibility is improved because map matching is oblivious to the hardware, and the system hardware can be updated without affecting map matching or a change in the map database.

17 Claims, 13 Drawing Sheets

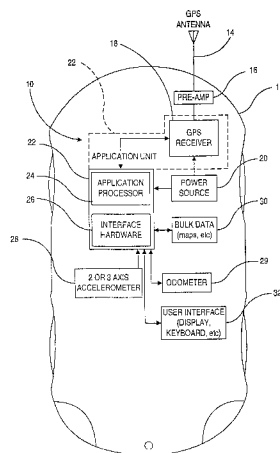

5,862,511

Page 2

U.S. PATENT DOCUMENTS

4,253,150	2/1981	Scovill	364/449
4,254,465	3/1981	Land	364/453
4,301,506	11/1981	Turco	364/436
4,312,577	1/1982	Fitzgerald	353/12
4,351,027	9/1982	Gay et al.	364/432
4,369,441	1/1983	Wohlmuth	340/733
4,403,291	9/1983	Von Tomkewitsch	364/424
4,504,913	3/1985	Miura et al.	364/449
4,513,377	4/1985	Hasebe et al.	364/449
4,528,552	7/1985	Moriyama et al.	340/525
4,543,572	9/1985	Tanaka et al.	340/723
4,546,439	10/1985	Esparza	364/444
4,570,227	2/1986	Tachi et al.	364/444
4,571,684	2/1986	Takanabe et al.	364/449
4,608,656	8/1986	Tanaka et al.	364/449
4,639,773	1/1987	Hurst	358/105
4,646,089	2/1987	Takanabe et al.	340/995
4,660,037	4/1987	Nakamura	340/990
4,675,676	6/1987	Takanabe et al.	340/995
4,711,125	12/1987	Morrison	73/178 R
4,758,959	7/1988	Thoone et al.	364/454
4,796,191	1/1989	Honey et al.	364/450
4,814,989	3/1989	Dobereiner et al.	364/444
4,819,175	4/1989	Wuttke	364/449
4,847,769	7/1989	Reeve	364/424.02
4,890,104	12/1989	Takanabe et al.	340/995
4,899,285	2/1990	Nakayama et al.	364/453
4,903,212	2/1990	Yokouchi et al.	342/327
4,930,085	5/1990	Kleinschmidt	342/358
4,949,268	8/1990	Nishikawa et al.	364/449
4,954,833	9/1990	Evans et al.	342/357
4,989,151	1/1991	Nuimura	364/449
5,014,205	5/1991	Sindlinger et al.	364/449
5,023,798	6/1991	Neukirchner et al.	364/449
5,046,011	9/1991	Kakahara et al.	364/449
5,058,023	10/1991	Kozikaro	364/450
5,075,693	12/1991	McMillan et al.	342/457
5,109,344	4/1992	Kakahara et al.	364/449
5,111,209	5/1992	Toriyama	342/357
5,119,102	6/1992	Barnard	342/357
5,166,882	11/1992	Stambaugh	701/220
5,179,519	1/1993	Adachi et al.	701/216
5,185,610	2/1993	Ward et al.	342/357
5,220,509	6/1993	Takemura et al.	701/216
5,233,844	8/1993	Mansell et al.	342/357
5,257,195	10/1993	Hirata	701/216
5,276,451	1/1994	Odagawa	342/357
5,278,424	1/1994	Kagawa	250/561
5,311,195	5/1994	Mathis et al.	342/357
5,317,515	5/1994	Matsuzaki	364/454
5,331,563	7/1994	Masumoto et al.	342/457
5,334,986	8/1994	Fernhout	342/357
5,337,243	8/1994	Shibata et al.	364/449
5,361,212	11/1994	Class et al.	364/460
5,367,463	11/1994	Tsuji	701/216
5,383,127	1/1995	Shibata	364/449
5,416,712	5/1995	Geier et al.	701/216
5,422,814	6/1995	Sprage et al.	364/460
5,434,788	7/1995	Seymour et al.	701/207
5,469,158	11/1995	Morita	364/460
5,483,457	1/1996	Shibata et al.	364/449.7
5,485,161	1/1996	Vaughn	364/449.7
5,488,559	1/1996	Seymour	364/450
5,508,931	4/1996	Snider	364/450
5,512,903	4/1996	Schmidtke	701/221
5,523,765	6/1996	Ichikawa	364/449.7
5,525,998	6/1996	Geier	364/449.7
5,539,647	7/1996	Shibata et al.	701/221
5,563,607	10/1996	Loomis et al.	701/213
5,583,776	12/1996	Levi et al.	364/450

5,594,453	1/1997	Rodal et al.	342/357
5,596,500	1/1997	Sprague et al.	701/213
5,629,708	5/1997	Rodal et al.	342/357

FOREIGN PATENT DOCUMENTS

0488594	6/1992	European Pat. Off.	.
0 496 538	7/1992	European Pat. Off.	.
0 514 887	11/1992	European Pat. Off.	.
0527558	2/1993	European Pat. Off.	.
0 544 403	6/1993	European Pat. Off.	.
0 567 268	10/1993	European Pat. Off.	.
3242904 A1	11/1982	Germany	.
3912108	4/1989	Germany	.
57-158875	9/1982	Japan	.
58009017	1/1983	Japan	.
58-27008	2/1983	Japan	.
58-113711	7/1983	Japan	.
58-11969	7/1983	Japan	.
58-78213	10/1983	Japan	.
60-135817	7/1985	Japan	.
59-28244	3/1995	Japan	.
1 470 694	4/1977	United Kingdom	.
2 014 309	8/1979	United Kingdom	.
2144 007	2/1985	United Kingdom	.
2 115 946	9/1993	United Kingdom	.
WO 92/10824	6/1992	WIPO	.

OTHER PUBLICATIONS

- Lezniak, et al.; A Dead Reckoning/Map Correlation System for Automatic Vehicle Tracking; pp. 47–60.
- May, 1973; Vehicular Technology; Antarctic Navigation; pp. 36–41.
- R. L. French; MAP Matching Origins Approaches and Applications; pp. 91–116.
- Sep. 1974; R. L. Fey; Automatic Vehicle Location Techniques for Law Enforcement Use; pp. 1–22.
- Tsumura, An Experimental System for Automatic Guidance of Ground Vehicle Following the Commanded Guidance Route on Map, pp. 2425–2430.
- Totani et al.; Automotive Navigation System; pp. 469–477.
- K. Mitamura et al.; SAE Technical Paper Series; The Driver Guide System; pp. 1–9.
- Thoone; CARIN, a car information and navigation system; Philips Technical Review; vol. 43, No. 11/12, Dec. 1987; pp. 317–329.
- T. Tsumura, et al.; A System for Measuring Current Position and/or Heading of Vehicles; pp. 3–8.
- Edward N. Skomal; Automatic Vehicle Locating Systems; pp. 1–12, 65–98, 319–320.
- AGARD; No. 176; Medium Accuracy Low Cost Navigation; pp. 28–1 to 28–31.
- K. Tagami, et al.; New Navigation Technology to Advance Utilization of Passenger Cars; pp. 413–422.
- Tagami et al.; SAE Technical Paper Series; “Electro Gyro-Cator” New Inertial Navigation System etc; pp. 1–15.
- AGARD; W. M. Aspin Comed–A Combined Display Including a Full Electronic Facility etc.; pp. 30–1 to 30–11.
- Evans; Chrysler Laser Atlas Satellite System (C.L.A.S.S.). pp. 1–31.
- R. L. French; The Evolution of Automobile Navigation, 1992, Arlington, Virginia.
- R. L. French, et al.; A Comparison of IVHS Progress in the United States, Japan and Europe.etc. Mar. 1994 pp. 17–22.
- M. Shibata, et al; Current Status and Future Plans for Digital Map Databases in Japan; Oct. 1993 pp. 29–33.
- Itoh, The Development of the Drive Guide System (japanese with English summary). 1989.

5,862,511

Page 3

- Business Week Magazine; Space-Age Navigation for the Family Car; pp. 82-84, 1984.
- Journal: Nissan Technical Review; The Development of a New Multi-AV System, 1991.
- Buxton, et al., The Travelpilot: A Second-Generation Automotive Navigation System, 1991.
- Pilsak, Eva-An Electronic Traffic Pilot for Motorists, 1986.
- French, The Evolving Roles of Vehicular Navigation, 1987, pp. 212, 216.
- Claussen, et al.; Status and Directions of Digital Map Databases in Europe; 1993, pp. 25-28.
- Jarvis, et al., Cathode-Ray Tube Information Center with Automotive Navigation, pp. 123-137.
- Dork, Satellite Navigation Systems for Land Vehicles; 1987, pp. 2-5.
- French, Automobile Navigation: Where is it Going? 1987, pp. 6-12.
- LaHaije, et al., Efficient Road-Map Management for a Car Navigation System, pp. 477-491.
- French, et al., Automatic Route Control System; 1973, pp. 36-41.
- Tsumura, et al., Automatic Vehicle Guidance—Commanded Map Routing, pp. 62-67.
- Sugie, et al., CARGuide—on board computer for automobile route guidance, pp. 695-706.
- McLellan, et al., Fleet Management Trials in Western Canada; pp. 797-806.
- Skomal, Comparative Analysis of Six Commercially Available Systems; pp. 34-45.
- Krause, et al. Veloc—A Vehicle Location and Fleet Management System.
- Dittloff, et al., Veloc—A New Kind of Information System; pp. 181-187; 1992.
- Article: Vehicle Positioning High Level Map Matching Design Document; pp. 1-25; 195.
- Brown, Low Cost Vehicle Location and Tracking using GPS; 1992.

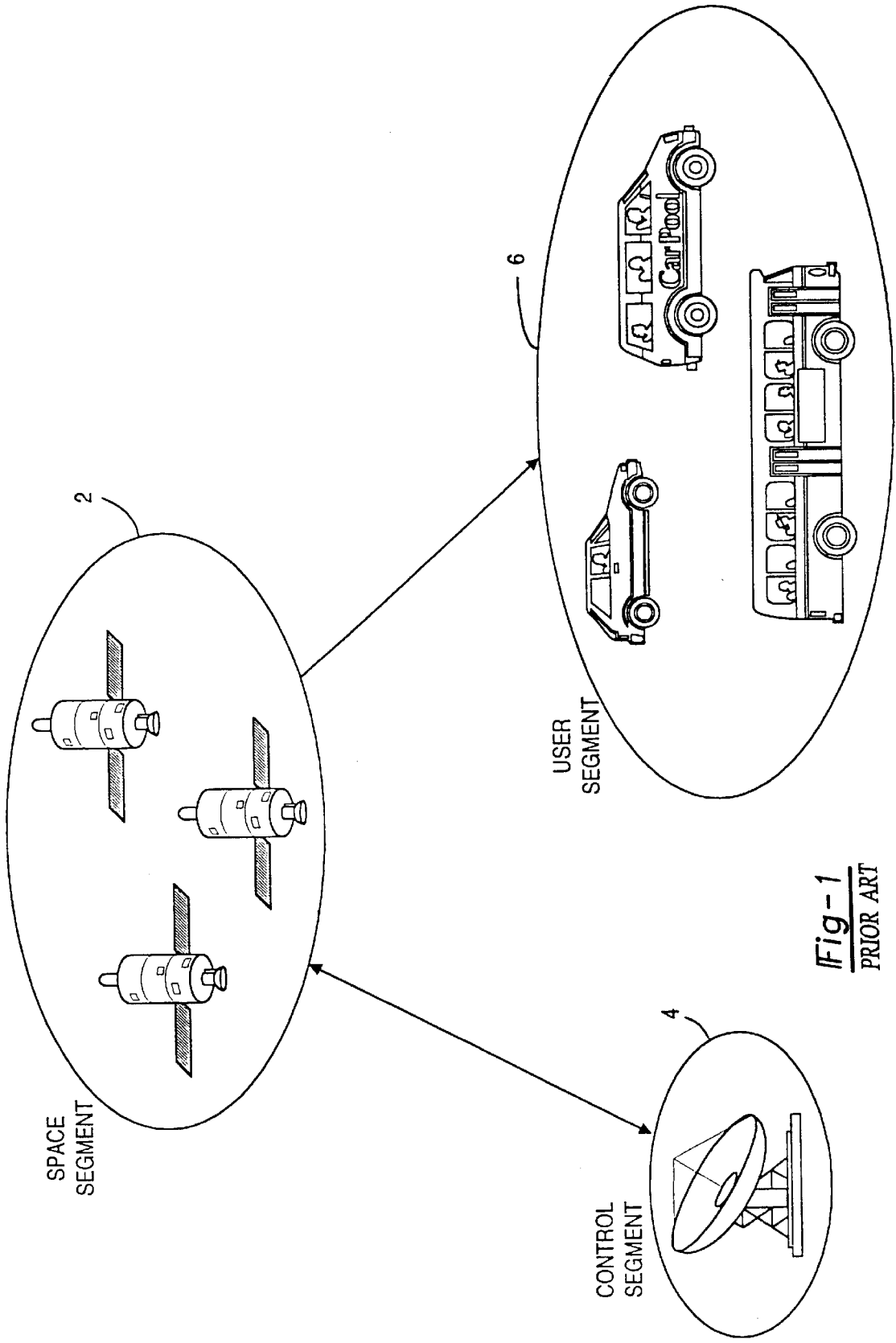

Fig-1
PRIOR ART

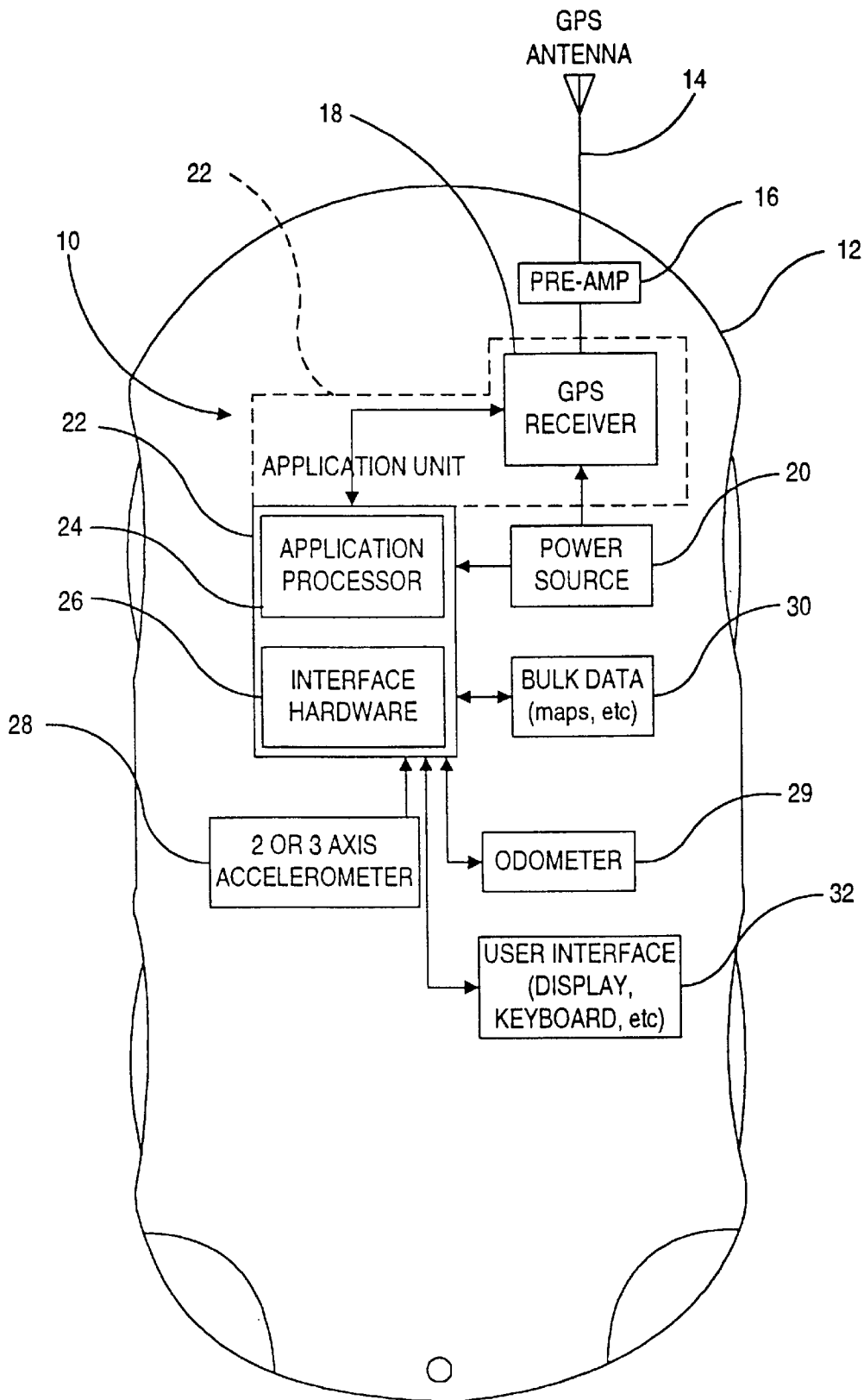

Fig-2a

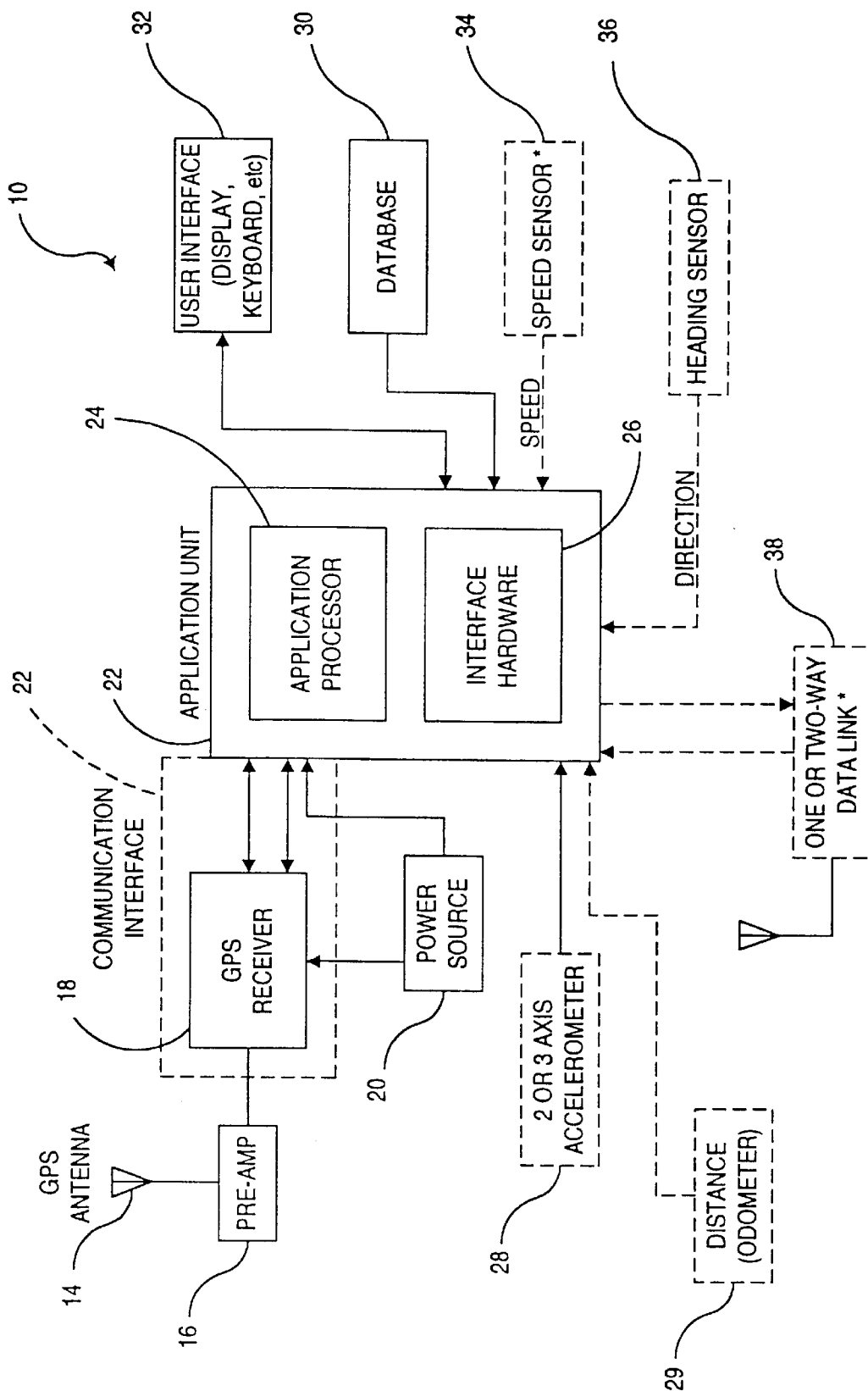

Fig-2b

* OPTIONAL

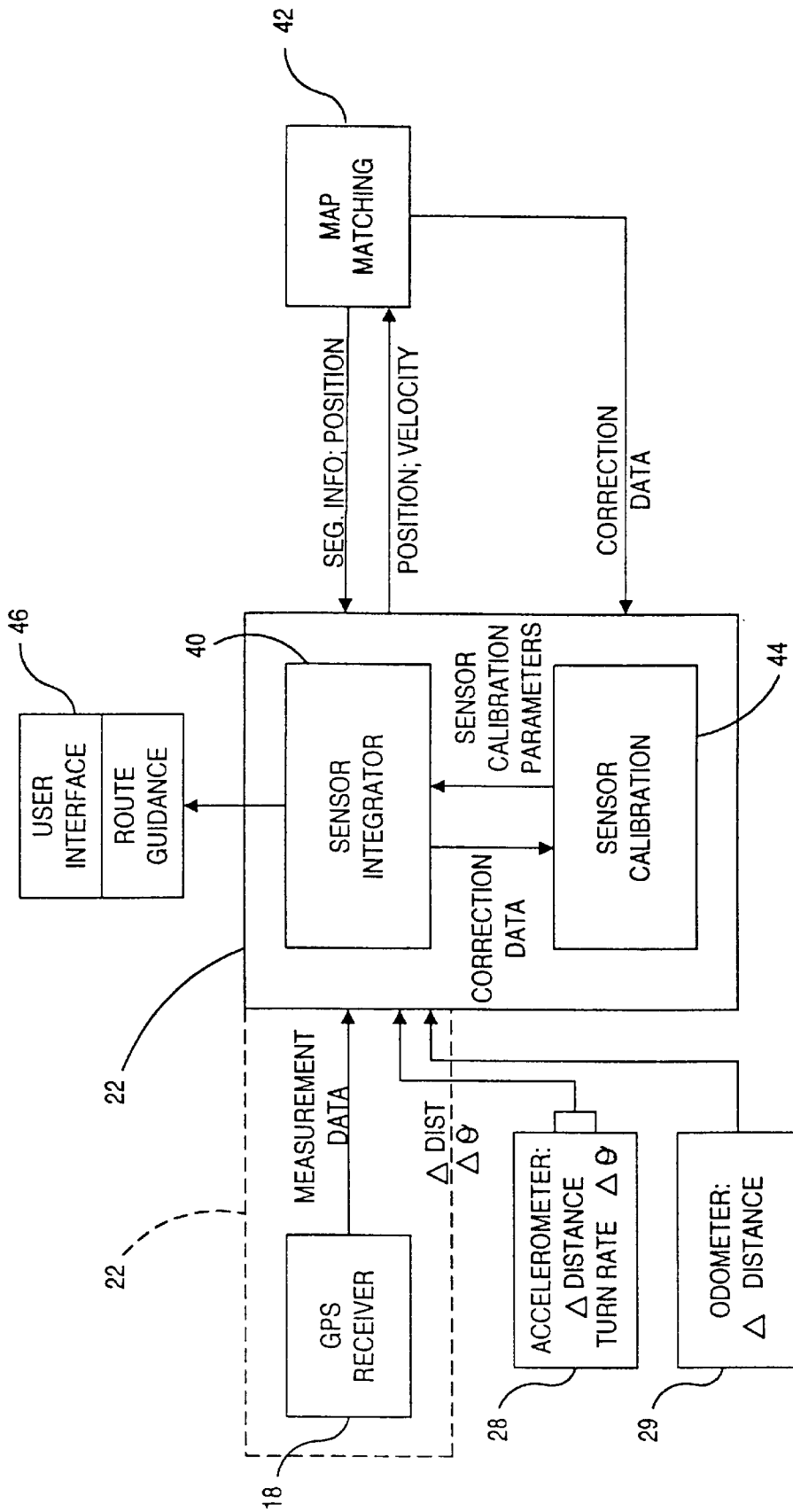

Fig - 3a

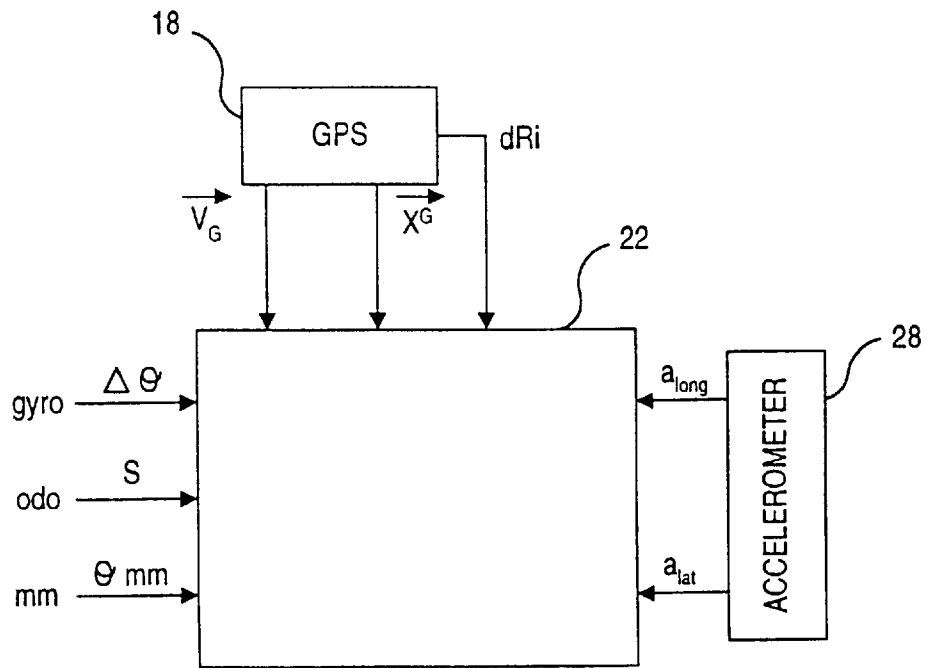

Fig-3b

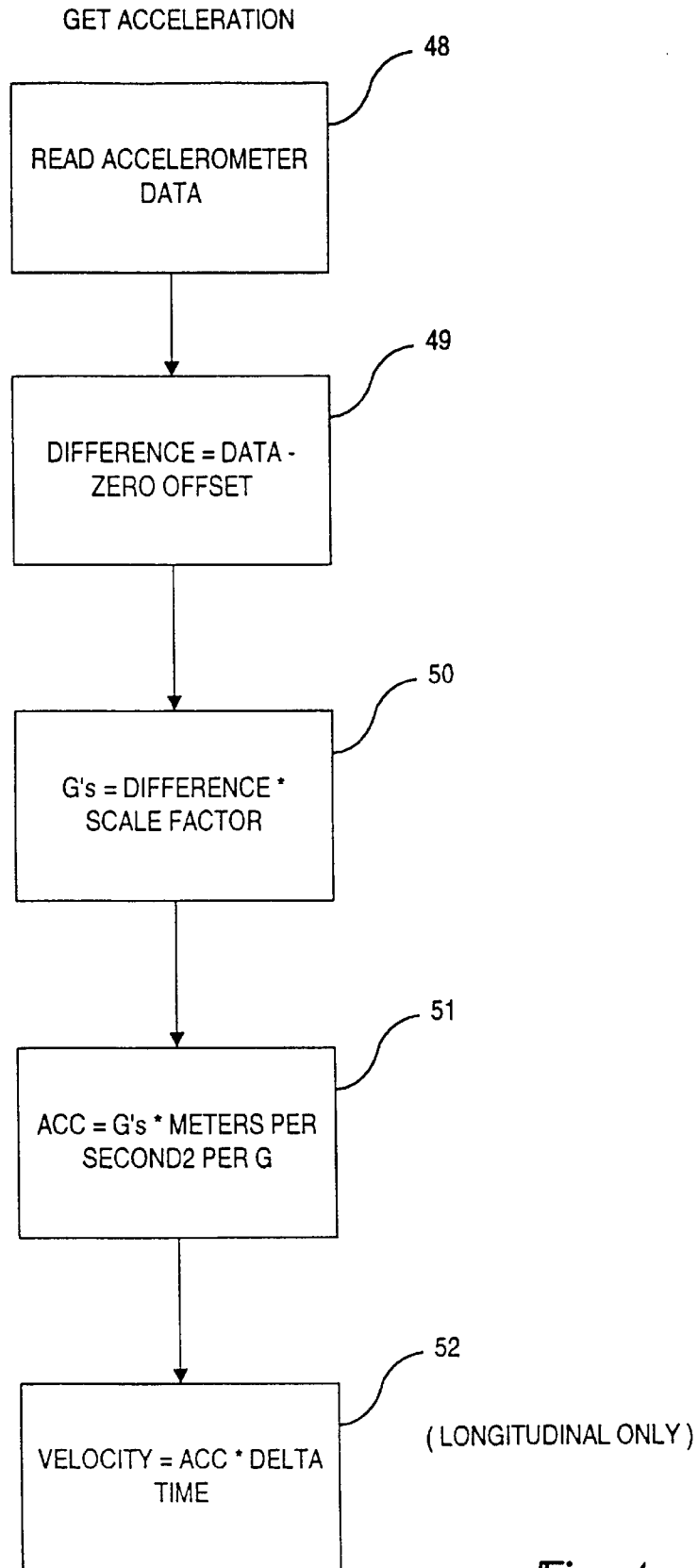

Fig-4a

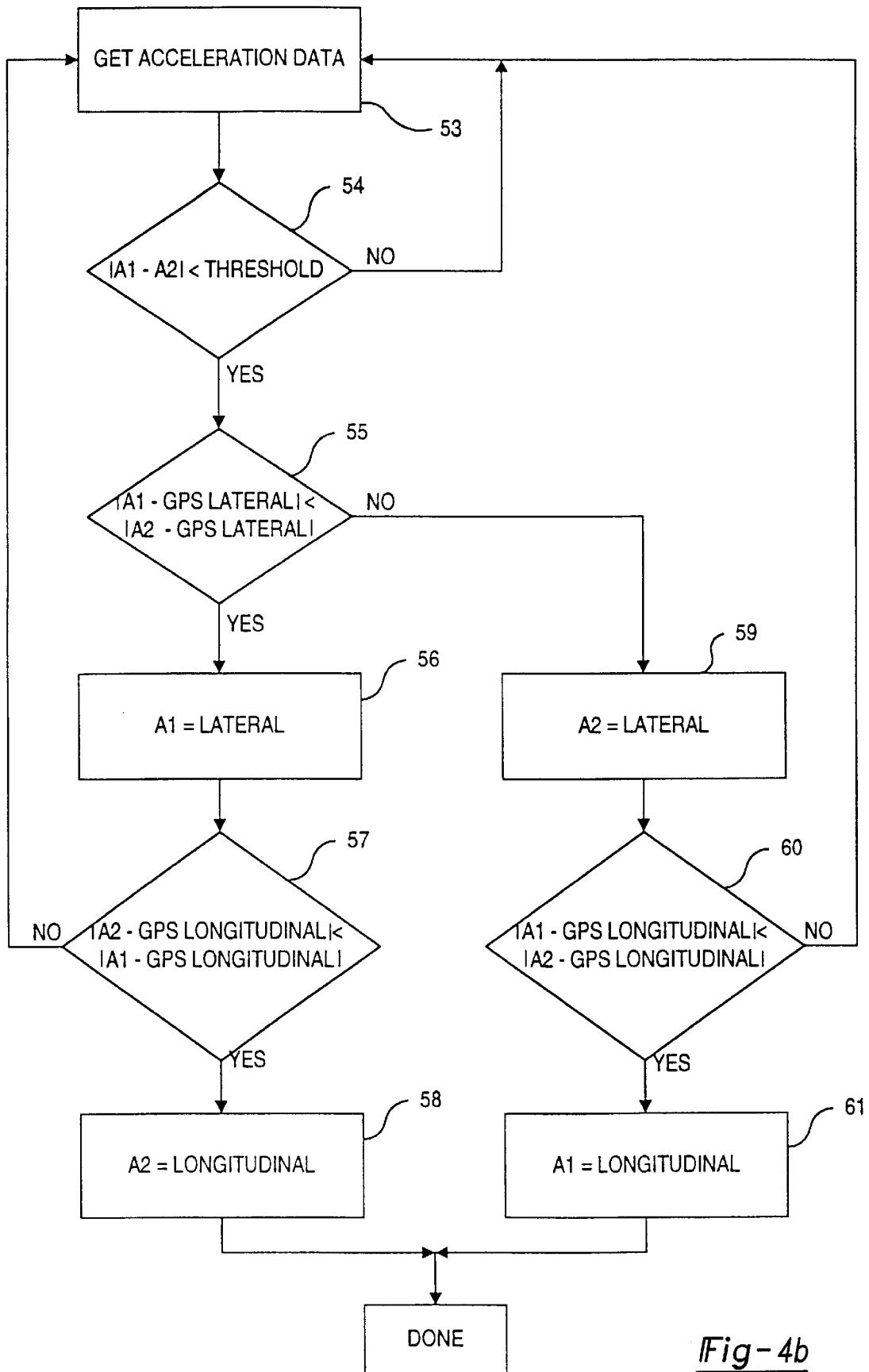

Fig-4b

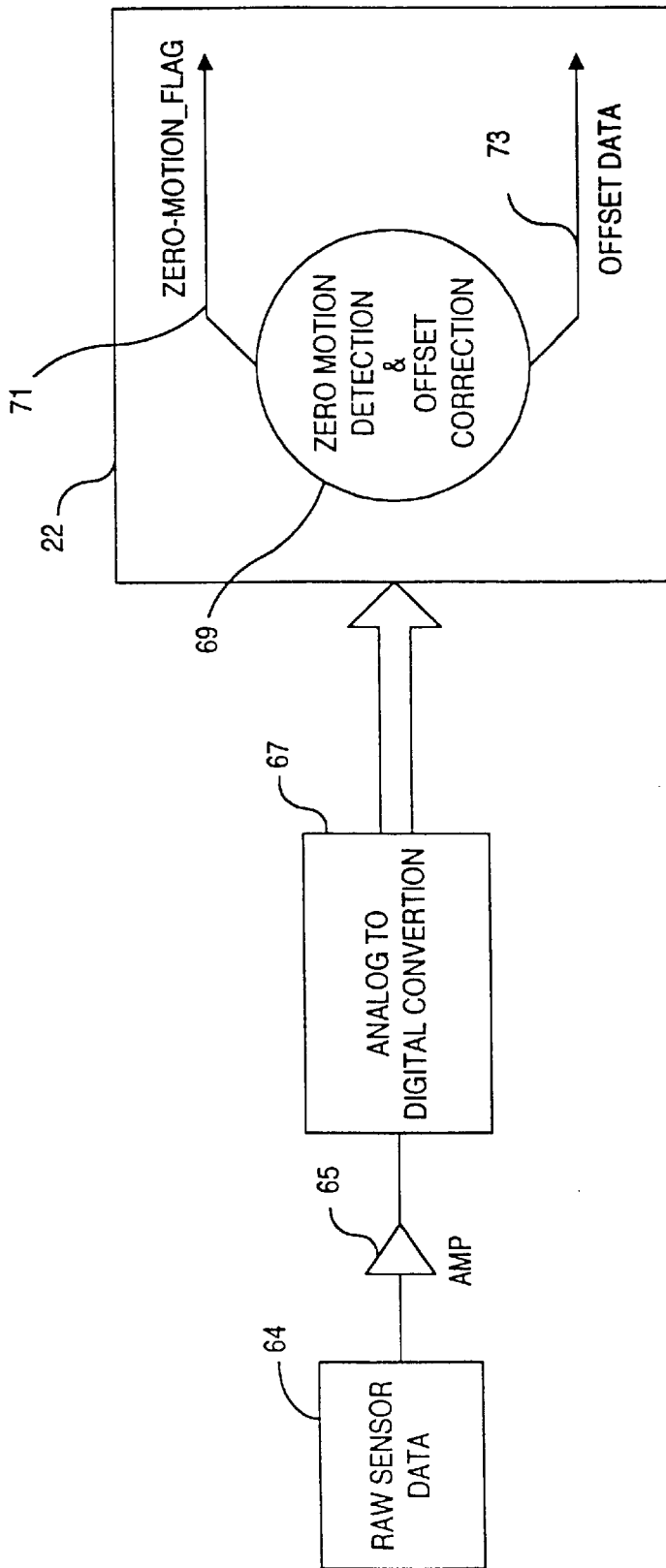

Fig - 5a

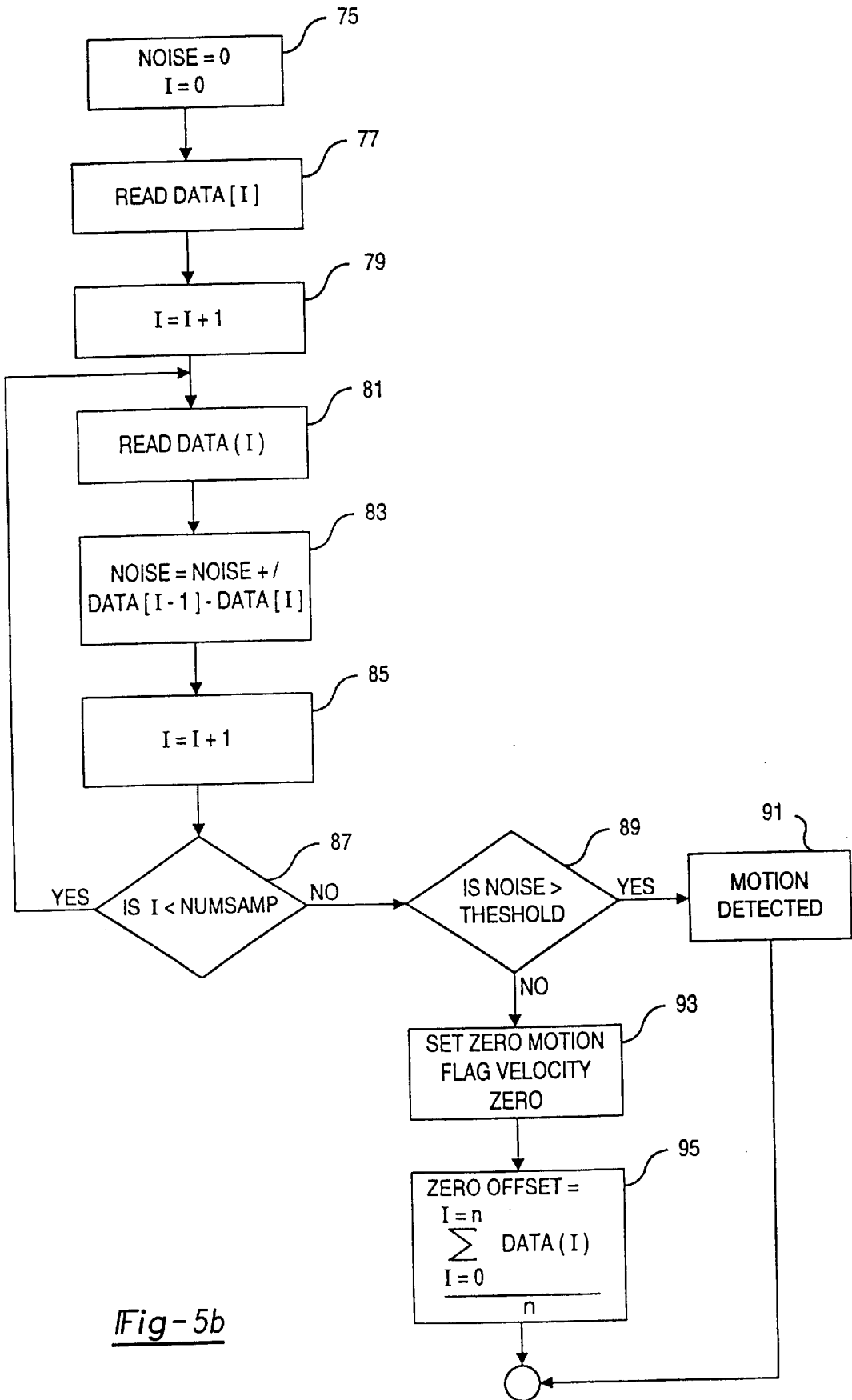
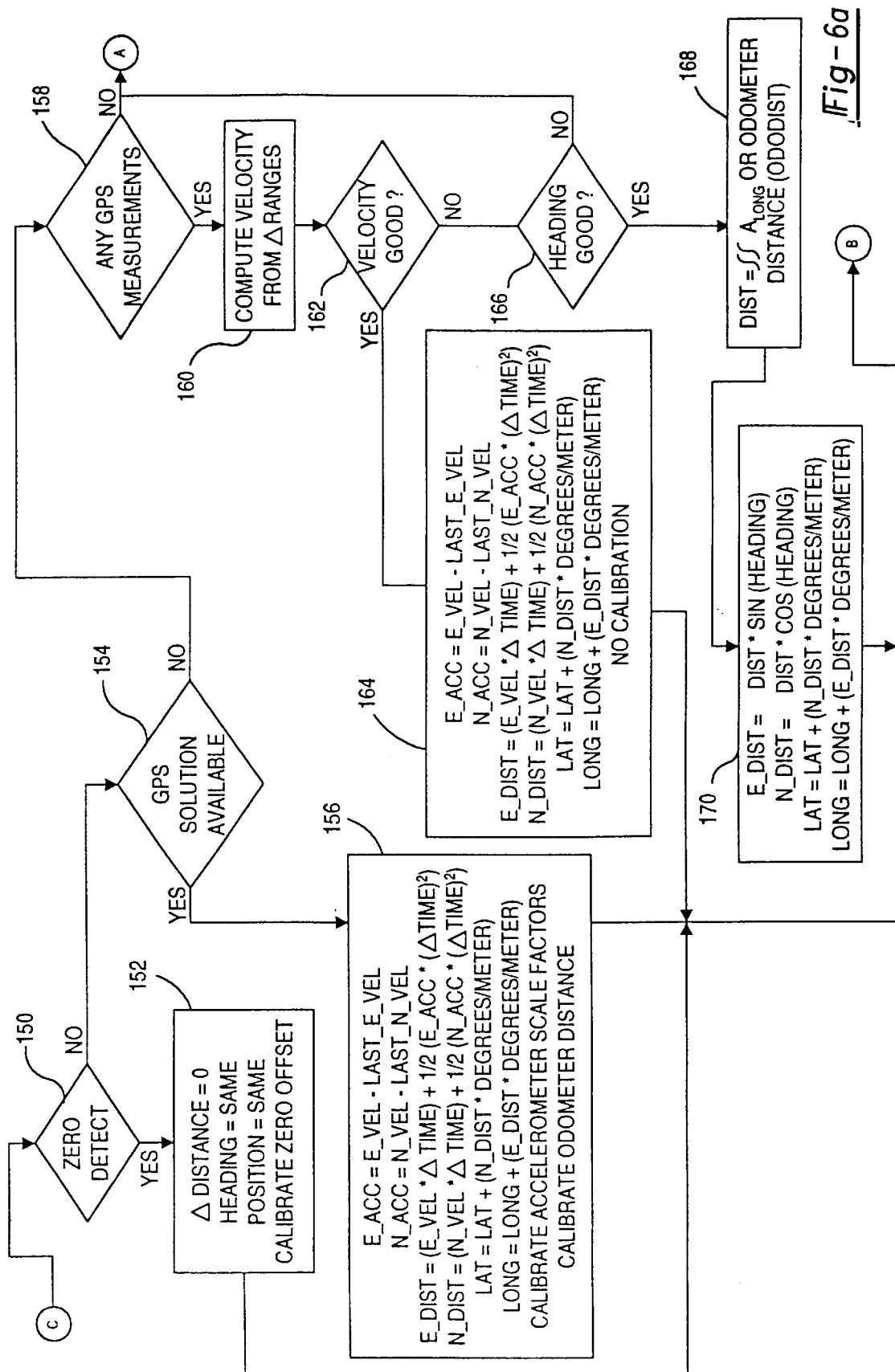

Fig-5b



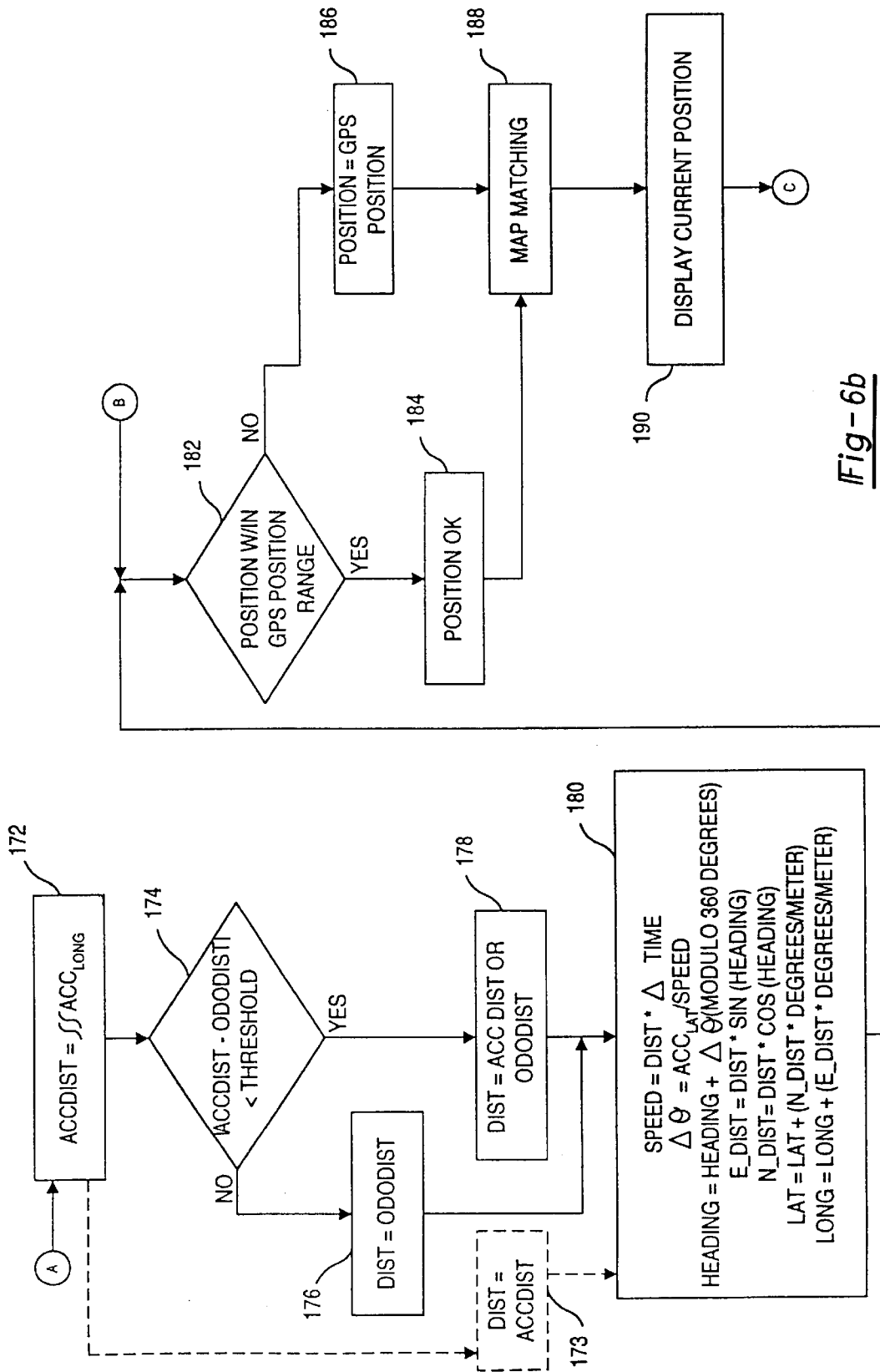

Fig-6b

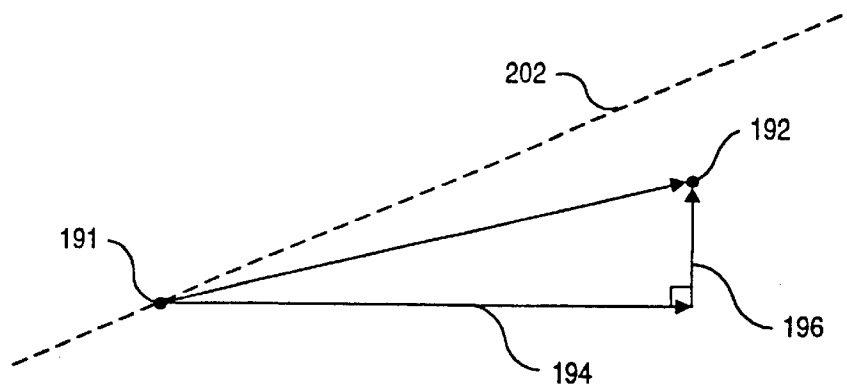

Fig-7a

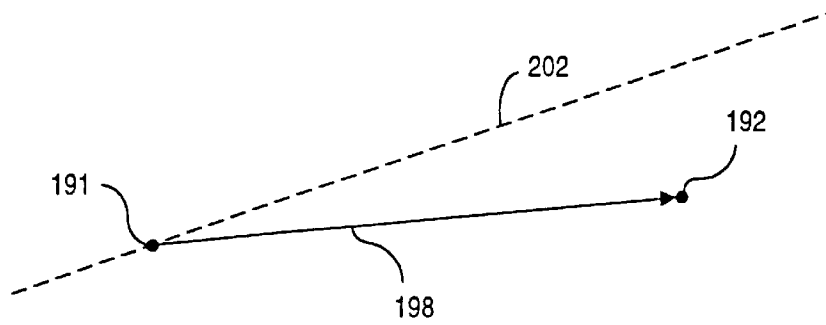

Fig-7b

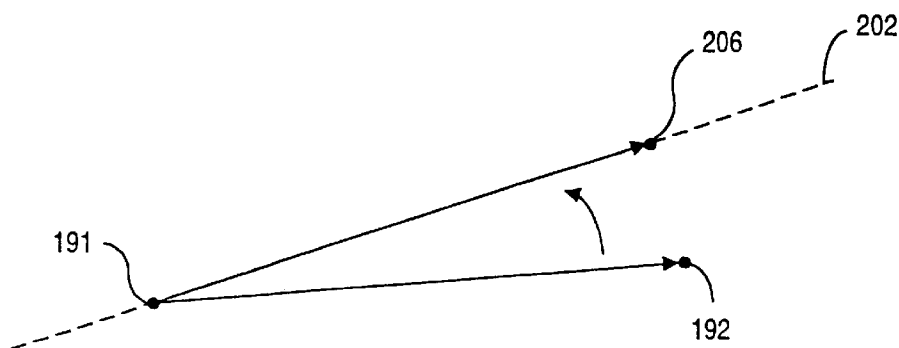

Fig-7d

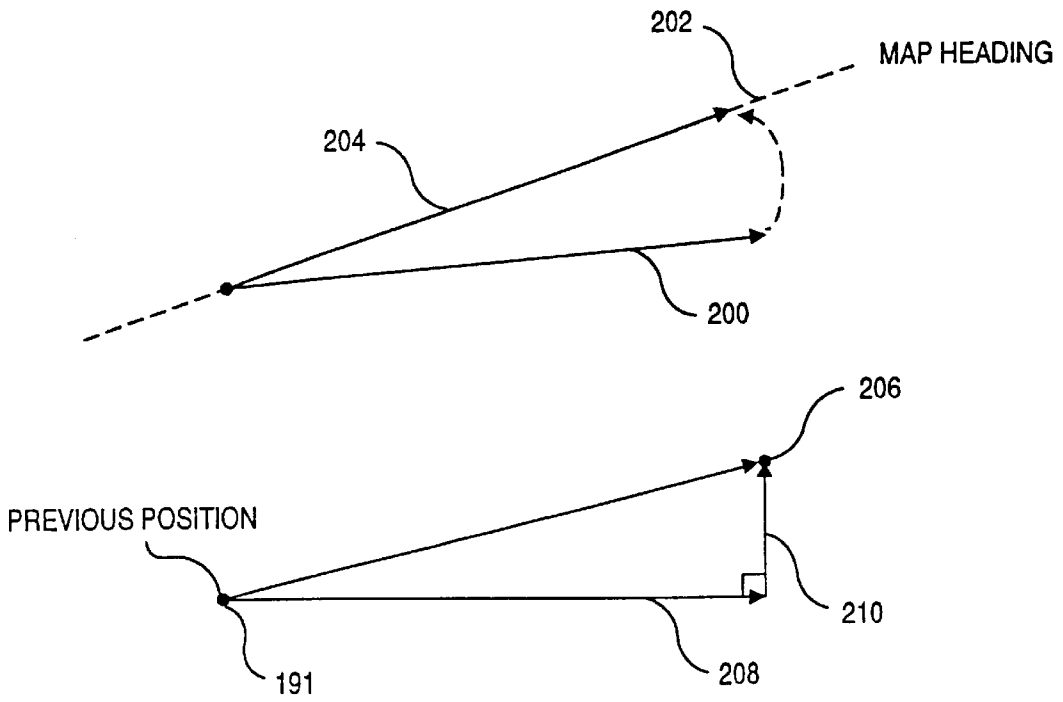

Fig-7c

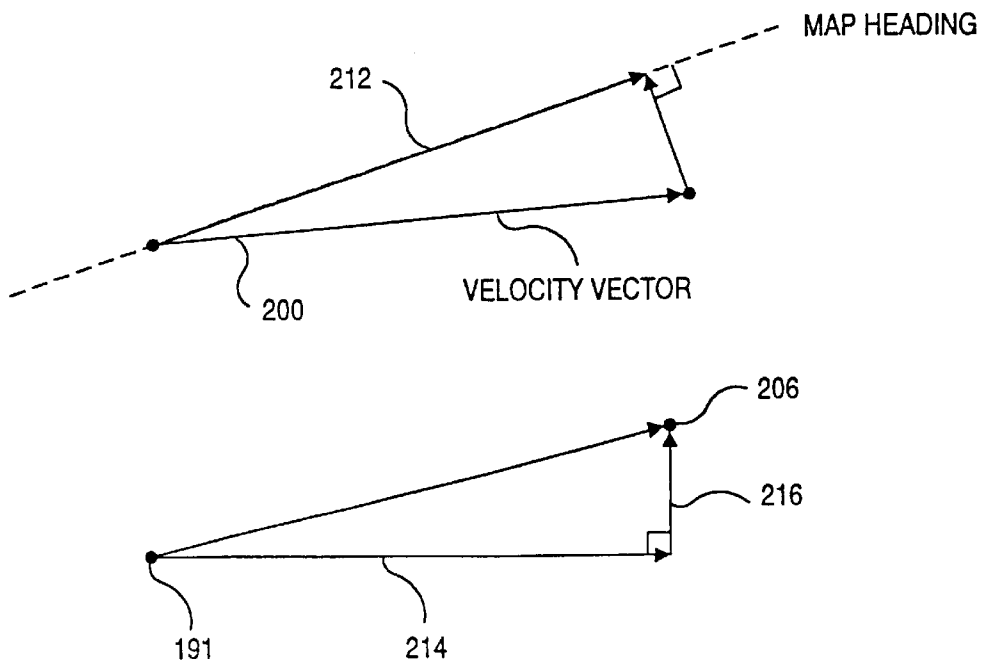

Fig-7e

5,862,511

1

VEHICLE NAVIGATION SYSTEM AND METHOD

FIELD OF THE INVENTION

The present invention relates generally to vehicle navigation systems. More particularly, the present invention relates to an improved vehicle navigation system and method using information from a Global Positioning System (GPS) to obtain velocity vectors for vehicle position propagation, and if information from the GPS is not available, then using information from a multiple axis accelerometer to propagate vehicle position.

BACKGROUND OF THE INVENTION

Current vehicle navigation systems use GPS, such as an electromagnetic wave positioning system, to determine a vehicle's position. Such a GPS system is the Navigation Satellite Timing and Ranging (NAVSTAR) Global Positioning System, which is a space-based satellite radio navigation system developed by the U.S. Department of Defense (DoD). GPS includes NAVSTAR GPS and its successors, Differential GPS (DGPS), or any other electromagnetic wave positioning systems. NAVSTAR GPS receivers provide users with continuous three-dimensional position, velocity, and time data.

NAVSTAR GPS consists of three major segments: Space, Control, and User as illustrated in FIG. 1. The space segment 2 consists of a nominal constellation of 24 operational satellites which have been placed in 6 orbital planes above the Earth's surface. The satellites are in circular orbits in an orientation which normally provides a GPS user with a minimum of five satellites in view from any point on Earth at any one time. The satellites broadcast an RF signal which is modulated by a precise ranging signal and a coarse acquisition code ranging signal to provide navigation data.

This navigation data, which is computed and controlled by the GPS control segment 4, includes the satellite's time, its clock correction and ephemeris parameters, almanacs, and health status for all GPS satellites. From this information, the user computes the satellite's precise position and clock offset.

The control segment consists of a Master Control Station and a number of monitor stations at various locations around the world. Each monitor station tracks all the GPS satellites in view and passes the signal measurement data back to the master control station. There, computations are performed to determine precise satellite ephemeris and satellite clock errors. The master control station generates the upload of user navigation data from each satellite. This data is subsequently rebroadcast by the satellite as part of its navigation data message.

The user segment 6 is the collection of all GPS receivers and their application support equipment such as antennas and processors. This equipment allows users to receive, decode, and process the information necessary to obtain accurate position, velocity and timing measurements. This data is used by the receiver's support equipment for specific application requirements. GPS supports a wide variety of applications including navigation, surveying, and time transfer.

GPS receivers may be used in a standalone mode or integrated with other systems. Currently, land-based navigation systems use vehicle speed sensor, rate gyro and a reverse gear hookup to "dead reckon" the vehicle position from a previously known position. This method of dead

2

reckoning, however, is susceptible to sensor error, and therefore requires more expensive sensors for accuracy and dependability.

The systems that use odometers, gyros and reverse gear hookups also lack portability due to the required connections to odometers and the frailty of gyros. Moreover, these systems are hard to install in different cars due to differing odometer configurations which can have different connections and pulse counts in the transmission. Odometer data also varies with temp, load weight, tire pressure, speed. Alternative connections to cruise control or ABS sensors bring up safety concerns.

Prior systems use a road network stored in a map database to calculate current vehicle positions. These systems send distance and heading information to perform map matching, and map matching calculates the current position based on the road network and the inputted data. These systems also use map matching to calibrate sensors. Map matching, however, has inherent inaccuracies because map matching must look back in time and match data to a location. As such, map matching can only calibrate the sensors when an absolute position is identified on the map, but on a long, straight stretch of highway, sensor calibration using map matching may not occur for a significant period of time.

Accordingly, there is a need for a potentially portable, vehicle navigation system which is flexible, accurate, efficient and cost-effective in determining a current position from a previous position.

SUMMARY OF THE INVENTION

The improved vehicle navigation system and method uses information from a Global Positioning System (GPS) to obtain velocity vectors, which include speed and heading components, for propagating or "dead reckoning" the vehicle position from a previous position. If information from the GPS is not available, then the improved vehicle navigation system uses information from an orthogonal axes accelerometer, such as two or three orthogonally positioned accelerometers, to propagate vehicle position. Because the GPS information should almost always be available, the improved vehicle navigation system relies less on its accelerometers, thereby allowing the use of less expensive accelerometers. The improved vehicle navigation system retains the accuracy of the accelerometers by repeatedly calibrating them with the velocity data obtained from the GPS information. The improved vehicle navigation system calibrates the sensors whenever GPS data is available (for example, once a second at relatively high speeds). Furthermore, the improved vehicle navigation system does not need to rely on map matching to calibrate sensors. System flexibility is improved because map matching is oblivious to the hardware, and the system hardware can be updated without affecting map matching or a change in the map database.

The use of accelerometers in the improved vehicle navigation system eliminates the need for connections to a heading sensor, speed sensors or a reverse gear, making the improved vehicle navigation system cheaper to install and potentially portable. The improved vehicle navigation system has sensors which are effectively calibrated because the scale factors for the accelerometers vary in a known manner dependent on temperature but fairly independent of other vehicle characteristics. In contrast, for example, an odometer loses accuracy if tire diameter changes due to falling tire pressure. If a third axis acceleration measurement sensor is added, the improved vehicle navigation system can operate

5,862,511

3

completely independent of vehicle sensors, further increasing flexibility in mounting. The third accelerometer provides pitch to assist in calibrating the other accelerometers and in providing more accurate information by, for example, detecting a banked turn.

In accordance with another aspect of the present invention, the improved vehicle navigation system interrogates a map database to obtain heading information for the mapped path segment which the vehicle is moving on. The improved vehicle navigation system updates the heading component for the velocity with the heading information from the map database. The updated velocity is used to propagate the vehicle position.

BRIEF DESCRIPTION OF THE DRAWINGS

Other aspects and advantages of the present invention may become apparent upon reading the following detailed description and upon reference to the drawings in which:

FIG. 1 is a general illustration of the various segments in the NAVSTAR GPS system;

FIG. 2a shows an improved vehicle navigation system using the improved position determination system according to the principles of the present invention, and FIGS. 2b show various hardware configurations for systems using aspects of the improved vehicle navigation system according to the principles of the present invention;

FIG. 3a shows a block/data flow diagram of the improved vehicle navigation system of FIG. 2a, and FIG. 3b shows a block data flow diagram of alternative improved vehicle navigation systems according to aspects of the present invention;

FIGS. 4a and 4b show flow charts for gathering acceleration information and orienting the multiple axis accelerometer;

FIG. 5a shows a block diagram of a zero motion detect system according to the principles of the present invention, and FIG. 5b shows a flow chart for the operation of the zero motion detect system of FIG. 5a;

FIGS. 6a and 6b show a general flow chart of the operation of the improved vehicle navigation system of FIG. 2a; and

FIGS. 7a-7e show general diagrams illustrating how the improved vehicle navigation system updates the heading information with the map heading for position propagations.

While the invention is susceptible to various modifications and alternative forms, specifics thereof have been shown by way of example in the drawings and will be described in detail. It should be understood, however, that the intention is not to limit the invention to the particular embodiment described. On the contrary, the intention is to cover all modifications, equivalents, and alternatives falling within the spirit and scope of the invention as defined by the appended claims.

DETAILED DESCRIPTION OF THE DRAWINGS

An illustrative embodiment of the improved vehicle navigation system according to the principles of the present invention and methodology is described below as it might be implemented to determine a current position from a previous position. In the interest of clarity, not all features of an actual implementation are described in this specification. It will of course be appreciated that in the development of any such actual implementation (as in any development project), numerous implementation-specific decisions must be made to achieve the developers' specific goals and subgoals, such

4

as compliance with system- and business-related constraints, which will vary from one implementation to another. Moreover, it will be appreciated that such a development effort might be complex and time-consuming, but would nevertheless be a routine undertaking of device engineering for those of ordinary skill having the benefit of this disclosure.

Aspects of the improved vehicle navigation system can be used in connection with a variety of system configurations in which GPS signals are used for position propagation. FIG. 2a illustrates, in block diagram form, an exemplary arrangement and use of an improved vehicle navigation system 10 for an automobile 12. In this embodiment, the improved vehicle navigation system 10 uses a GPS antenna 14 to receive the GPS signals. The antenna 14 is preferably of right-hand circular polarization, has a gain minimum of -3 dBiC above 5 degree elevation, and has a gain maximum of +6 dBiC. Patch or Helix antennas matching these specifications can be used. The GPS antenna 14 can be connected to a preamplifier 16 to amplify the GPS signals received by the antenna 14. The pre-amplifier 16 is optional, and the GPS antenna can be directly connected to a GPS receiver 18, which is powered by a power source 20 for the vehicle navigation system 10.

The GPS receiver 18 continuously determines geographic position by measuring the ranges (the distance between a satellite with known coordinates in space and the receiver's antenna) of several satellites and computing the geometric intersection of these ranges. To determine a range, the receiver 18 measures the time required for the GPS signal to travel from the satellite to the receiver antenna. The timing code generated by each satellite is compared to an identical code generated by the receiver 18. The receiver's code is shifted until it matches the satellite's code. The resulting time shift is multiplied by the speed of light to arrive at the apparent range measurement.

Since the resulting range measurement contains propagation delays due to atmospheric effects, and satellite and receiver clock errors, it is referred to as a "pseudorange." Changes in each of these pseudoranges over a short period of time are also measured and processed by the receiver 18. These measurements, referred to as "delta-pseudoranges," are used to compute velocity. Delta ranges are in meters per second which are calculated by the receiver from pseudoranges, and the GPS receiver 18 can track the carrier phase of the GPS signals to smooth out the pseudoranges. The velocity and time data is generally computed once a second. If one of the position components is known, such as altitude, only three satellite pseudorange measurements are needed for the receiver 16 to determine its velocity and time. In this case, only three satellites need to be tracked.

GPS accuracy has a statistical distribution which is dependent on two important factors. The accuracy which can be expected will vary with the error in the range measurements as well as the geometry or relative positions of the satellites and the user. The Geometric Dilution of Precision (GDOP) indicates how much the geometric relationship of the tracked satellites affects the estimate of the receiver's position, velocity, and time. There are four other DOP components which indicate how the geometry specifically affects errors in horizontal position (DOP), vertical position (VDOP), position (PDOP), and time (TDOP).

DOPs are computed based on the spatial relationships of the lines of sight between the satellites and the user. The motion of the satellites relative to each other and the user causes the DOPs to vary constantly. For the same range

measurement errors, lower DOPs relate to more accurate estimates. The errors in the range measurements which are used to solve for position may be magnified by poor geometry. The least amount of error results when the lines of sight have the greatest angular separation between them.

For example, if two lines of sight are necessary to establish a user position, the least amount of error is present when the lines cross at right angles. The error in the range measurement is dependent on one of two levels of GPS accuracy to which the user has access. PPS is the most accurate, but is reserved for use by the DoD and certain authorized users. SPS is less accurate and intended for general public use. The SPS signal is intentionally degraded to a certain extent by a process known as Selective Availability (SA). SA is used to limit access to the full accuracy of SPS in the interest of U.S. national security. Differential GPS (DGPS) may be used to correct certain bias-like errors in the GPS signals. A Reference Station receiver measures ranges from all visible satellites to its surveyed position. Differences between the measured and estimated ranges are computed and transmitted via radio or other signals to differential equipped receivers/hosts in a local area. Incorporation of these corrections into the range measurements can improve their position accuracy.

As shown in FIG. 2a, the GPS receiver 18 provides GPS measurements to an application unit 22. The application unit 22 consists of application processing circuitry 24, such as a processor, memory, busses, the application software and related circuitry, and interface hardware 26. In one embodiment of the present invention, the application unit 22 can be incorporated into the GPS receiver 18. The interface hardware 26 integrates the various components of the vehicle navigation system 10 with the application unit 22. In this embodiment, a 2 or 3 axis accelerometer 28 provides acceleration signals to the application unit 22. The accelerometer 28 can include recently available and low cost, micro-machined accelerometers. An odometer 29 provides information which can be used in place of the information derived from the accelerometers, but the odometer 29 is optional because it reduces the portability of the system. A map database 30 stores map information, such as a road network, and provides map information to the application unit 22. The map database should have some level of known accuracy, confidence, or defined error. In this embodiment, every change in street segment heading is designated as a shape point which has a heading with a fixed measurement error. A user interface 32, which includes a display and keyboard, allows interaction between the user and the improved vehicle navigation system 10.

FIGS. 2b shows alternative configurations which can incorporate aspects of the improved vehicle navigation as would be understood by one of skill in the art. FIG. 2b contains reference numerals which correspond to the reference numerals of FIG. 2a. FIG. 2b shows that a system 10 can include a combination of the features, such as those shown in dashed lines. For example, the improved vehicle navigation system could rely upon information provided by the GPS receiver 18, the orthogonal axes accelerometer 28 and the map database 30 to propagate vehicle position. In additional embodiments, the improved vehicle navigation system 10 uses the orthogonal axes accelerometer 28, odometer 29 and the map database 30 according to other aspects of the present invention. Other embodiments can include a speed sensor 34, a heading sensor 36, such as a gyro, compass or differential odometer, and a one or two way communication link 38. Other configurations and combinations are possible which incorporate aspects of the present

invention as would be understood by one of ordinary skill in the art. Moreover, the improved vehicle navigation system can be incorporated in an advanced driver information system which controls and provides information on a variety of automobile functions.

FIG. 3a shows a block and data flow diagram for the improved vehicle navigation system 10 of FIG. 2a. The GPS receiver 18 provides position information, velocity information, pseudoranges and delta pseudoranges to the sensor integrator 40. The sensor integrator 40 uses the velocity information to determine a current position for the vehicle. In this embodiment, if GPS velocity information is not available, the sensor integrator 40 can calculate GPS velocity using the available delta range measurements to determine a current position. GPS velocity information is derived from a set of delta range measurements, and if only a subset of delta range measurements is available, the vehicle navigation system can derive GPS velocity information from the subset of delta range measurements. The vehicle navigation system uses the GPS position information at start-up as a current position and as a check against the current position. If the current position fails the check, then the GPS position can replace the current position.

In accordance with another aspect of the present invention, FIG. 3b shows the flexibility and accuracy of certain embodiments of the improved vehicle navigation system. The vehicle positioning block 22 receives longitudinal acceleration information, a_{long} , a lateral acceleration information, a_{lat} , a gyro heading, θ_g , an odometer distance, S , map heading, θ_{mm} , and GPS information, including a velocity vector \vec{v}_G , a position vector \vec{x}_G and delta range measurements dRi . When GPS velocity information is available and reliable, the vehicle positioning 22 propagates the position vector $\vec{x}(t)$ with the GPS velocity vector \vec{v}_G as follows: $\vec{x}(t) = \vec{x}(t-1) + \vec{v}_G \Delta t$. If the difference between the GPS heading and the map heading is within a threshold, the map heading is used as the heading. If the GPS velocity information is not available or unreliable (at low velocities below 1.5 m/s), the vehicle positioning will propagate the position vector $\vec{x}(t)$ using the available velocity vector with the most merit as follows: $\vec{x}(t) = \vec{x}(t-1) + \vec{v} \Delta t$.

In this particular embodiment, the improved vehicle navigation system can obtain the information used to propagate the vehicle position from several sources such as the available GPS delta range measurement(s), the orthogonal axes accelerometer using lateral and longitudinal acceleration information, the odometer distance and GPS heading, a distance calculation and map heading, the GPS speed information and map heading, gyro heading and longitudinal speed and other variations. In this embodiment, if the difference between the current heading and map heading is less than a threshold value, then the map heading is used as the heading. Vehicle positioning 22 calibrates \vec{v}_a from \vec{v}_G when possible. The GPS position information is used as an overall check on the current position. For example, if $|\vec{x}(t) - \vec{x}_G(t)| < (18.5 * PDOP)$, then $\vec{x}(t) = \vec{x}_G(t)$. Otherwise, $\vec{x}(t) = \vec{x}_G(t)$. In certain embodiments, all raw inputs could go into a Kalman filter arrangement which outputs the velocity vector.

The sensor 28 for the embodiments of FIGS. 3a and 3b, which is a multiple axis accelerometer, provides acceleration information for at least two orthogonal axes (lateral, longitudinal and/or vertical). The accelerometers 28 produce a

5,862,511

7

voltage measure. As shown in FIG. 4a for the longitudinal accelerometer, the accelerometer data is read at step 48, and the zero offset (set at the factory and constantly re-checked and reset by the Zero Motion Detector mentioned below) is subtracted from this measure at step 49 to produce a number of volts displaced from zero. This number of volts displaced from zero is then multiplied by a scale factor (set at the factory and continuously re-calibrated by the GPS) to produce a number of G's of acceleration at step 50. This number of G's of acceleration is then multiplied by the number of meters per second squared per G to produce meters per second squared of acceleration at step 51. The meters per second squared of acceleration is then multiplied by the delta time (integrated once) to produce a velocity at step 52. This velocity is saved for the next second. This acceleration information can be used to determine change in distance information, ΔDIST , and change in turn rate information, $\Delta\theta$.

Initially, the improved vehicle navigation system requires initial conditions for various items, such as accelerometer orientation, accelerometer zero offset, accelerometer scale factor, odometer pulses per mile, and initial vehicle orientation. Factory defaults will be used for each of these items so that no initialization will be necessary. Those items will also need to be maintained, but not necessarily in the absence of all power (i.e. battery loss, or removal from vehicle). An option will be available to manually initialize these items. This would allow immediate use of the system, without having to wait for GPS to be acquired for calibrating these items.

Once GPS has been acquired and is determined to be useable based on its Figure of Merit, GDOP, and Number of Satellite Measurements Used, GPS can be used to calibrate all of the configurable items. It will first determine the accelerometer orientation as described in FIG. 4b. At power on, the assignment of accelerometers to each of the lateral, longitudinal and down axes (if three axis accelerometer is used) are in the same orientation as the last power down, which will be saved in some non-volatile storage. If three accelerometers are used, one will be measuring the Earth's gravity. The accelerometer measuring one G (Earth's Gravity) will be assigned to the Down Axis. For the other two axes, as shown in FIG. 4b, the following procedure will take place. At step 53, the acceleration data is obtained as described in FIG. 4b. The acceleration measurements from each of the two accelerometers will be compared until their difference reaches a pre-defined threshold at step 54. The reason for this is to ensure that the accelerations are uneven enough that a valid compare against current vehicle conditions can be made without ambiguity.

As shown in steps 55-61 for this particular embodiment, once this situation occurs and there is acceleration data computed from the GPS data, the acceleration from each of the accelerometers will be compared to the lateral and longitudinal accelerations computed from the GPS and the accelerometers with the closest acceleration values for each of those axes will be assigned to those axes. Additionally, the initial vehicle orientation is determined because the vehicle heading relative to True North can be computed from the GPS velocities.

With reference to FIG. 3a, the sensor integrator 40 can use the longitudinal and lateral acceleration information as described below to determine a current position for the vehicle if GPS velocity information is not available. In any event, if GPS is available or not, the sensor integrator 40 provides the current position and a velocity (speed and heading) to a map matching block 42. The map matching

8

block 42 provides road segment information for the road segment that the vehicle is determined to be travelling on, such as heading, and a suggested position. The sensor integrator 40 can update the heading component of the velocity information with the heading provided by the map matching block 42 to update the current position. If the map matching block 42 indicates a good match, then the map matched position can replace the current position. If not, the sensor integrator propagates the previous position to the current position using the velocity information. As such, the sensor integrator 40 determines the current position and provides the current position to a user interface and/or route guidance block 46.

The map matching block 42 also provides correction data, such as a distance scale factor and/or offset and a turn rate scale factor and/or offset, to a sensor calibration block 44. The sensor integrator 40 also provides correction data to the sensor calibration block 44. The correction data from the sensor integrator 40, however, is based on the GPS information. Thus, accurate correction data based on the GPS information is continuously available to calibrate the sensors 28 (2 or 3 axis accelerometer) as well as for other sensors 29, 34 and 36 depending on the particular embodiment. The correction data from the map matching block may be ignored by the sensor calibration block 44 until a good match is found between the map information and the current position. If a highly accurate match is found by map matching 42, most likely after a significant maneuver such as a change in direction, the map matched position is used as a reference point or starting position for position propagation according to the principles of the present invention.

The sensor calibration block 44 contains the sensor calibration parameters, such as scale factors and zero factors for the sensors 28, 29 and provides the calibration parameters to the sensor integrator 40 to calibrate the sensors 28, 29. In one embodiment, the system can combine the sensor integrator 40 and sensor calibration 44 into GPS engine 18 using its processor. In certain embodiments, the route guidance and user interface, the sensor integrator 40 and the sensor calibration 44 is performed on an application specific integrated circuit (ASIC).

If the accuracy of a current position is determined to be high (for example, a map matched position at a isolated turn), the improved vehicle navigation system 10 can update the current position with the known position. After the vehicle has moved a distance from the known position which is now a previous position, the improved vehicle navigation system must accurately propagate the vehicle position from the previous position to the current position.

The calculations that will be performed to compute the vehicle position will take place in three coordinate frames. The vehicle position will be reported in geodetic coordinates (latitude, longitude, altitude). The non-GPS data will be provided in body or platform coordinates. The GPS velocities and the equations used for velocity propagation of position will take place in the North, East, Down frame.

The geodetic frame is a representation of the Earth Centered Earth Fixed (ECEF) coordinates that is based on spherical trigonometry. This is the coordinate frame that the mapping database uses. Its units are degrees and meters displacement in height above the geoid. These coordinates will be with respect to the WGS-84 Earth model, which is the Earth model used by the Global Positioning System (GPS). This is mathematically equivalent to the North American Datum 1983 (NAD 83) system which the mapping database is referenced to. The North East Down frame

is a right-handed orthonormal coordinate system fixed to the vehicle with its axes pointing to the True North, True East, and True Down (perpendicular to the Earth) directions. The body coordinates form a right-handed orthonormal coordinate system with their origin at the navigation unit, the x axis pointing toward the nose of the vehicle, the right axis pointing out the right door of the vehicle and the z axis pointing down perpendicular to the Earth.

During normal operation of the system, and with GPS available, the following are the equations that will be used for computing the vehicle position and the calibration of the accelerometers and odometer.

Definitions:

- \vec{x} =position vector [latitude longitude altitude]
- \dot{x} =velocity vector [north east down]
- \ddot{x} =acceleration vector [north east down]
- C_N^B =Transformation matrix which rotates a vector from the Body coordinate frame to the North East Down coordinate frame.

The following superscripts will be used to denote the origin of the data:

- G=GPS
- A=Accelerometer
- O=Odometer

The following subscripts will denote time—either time of validity or time period of integration:

- t=current time
- t-1=time of last data set before the current data set
- t-2=time of data set before t-1

Note that t-1 and t-2 do not necessarily imply a one second difference, but only data collection and/or data validity times.

The following subscripts will denote coordinate reference frames:

- N=North East Down
- B=Body (Nose Right Door Down)
- G=Geodetic (latitude longitude height)

To use the information from the non-GPS sensors, their data needs to be rotated from the body frame to the North East Down frame. This is a rotation about the yaw axis measured in degrees from True North to the Nose Axis of the vehicle. The equations for this is:

$$\vec{x}^N = C_N^B(\vec{x}^B).$$

The steady state position propagation equation is based on the physical definition of velocity and acceleration. The current position is equal to the previous position plus the integral of velocity plus the double integral of acceleration.

$$\vec{x}_t = x_{t-1} + \int_{t-1}^t \dot{x} dt + \int_{t-1}^t \left(\int_{t-1}^t \ddot{x} dt \right) dt$$

The following information is collected at time t:

- \dot{x}_{t-1}^G The velocity from GPS which was valid at the previous second. This consists of:
 - \dot{x}^e =Velocity in the True East direction (meters/second);
 - \dot{x}^n =Velocity in the True North direction (meters/second);

\dot{x}^u =Velocity in the Up direction (meters/ second);

-
- \ddot{x}_{t-1}^G The acceleration computed from GPS velocities that was valid from time t-2 to time t-1;
 - \vec{x}_{t-1} The raw GPS position;
 - \dot{x}_{t-1}^O The speed computed from the number of odometer counts that occurred from time t-1 to time t; and
 - \ddot{x}_{t-1}^A The acceleration computed from the accelerometers which occurred from time t-1 to time t.
-

The following other information is available for use at time t, but was collected at a previous time:

-
- \dot{x}_{t-2}^G The velocity from GPS which was valid two time units ago;
 - \vec{x}_{t-2} The position computed at the previous time;
 - \ddot{x}_{t-1}^A The acceleration, computed from the accelerometers, from time t-2 to time t-1; and
 - \dot{x}_{t-1}^O The velocity computed from the odometer counts from time t-2 to time t-1.
-

When GPS is available and has produced a valid position and velocity solution, the following equation will be used for the propagation of the vehicle position:

$$\vec{x}_t = x_{t-1} + \int_{t-1}^t \dot{x} dt + \int_{t-1}^t \left(\int_{t-1}^t \ddot{x} dt \right) dt$$

or

$$\vec{x}_t = x_{t-1} + (\dot{x}_{t-1}^G * \Delta t) + \left(\left(\frac{1}{2} \ddot{x}_{t-1}^A * (\Delta t)^2 \right) + \left(\left(\frac{1}{2} \ddot{x}_{t-1}^G * (\Delta t)^2 \right) - \left(\frac{1}{2} \ddot{x}_{t-1}^A * (\Delta t)^2 \right) \right) \right)$$

This equation is: the current position is equal to the previous position plus the GPS velocity (vector) times the delta time plus the Accelerometer acceleration from two time periods ago minus the Accelerometer acceleration from two time periods ago (a correction factor) plus the Accelerometer acceleration from the current second. In certain embodiments, other sensor information, such as the odometer information, can be used in the above equations if it is determined to be more appropriate than the accelerometer information.

Also computed at this second are:

- (1) the GPS heading θ computed as the inverse tangent of the East and North velocities:

$$\theta = \text{atan} \left(\frac{\dot{x}^e}{\dot{x}^n} \right);$$

- (2) the distance from time t-1 to time t, computed from the GPS velocity valid at time t-1 and the double integration of the longitudinal Accelerometer acceleration from time t-1 to time t:

5,862,511

11

$$s = \sqrt{(\dot{x}_{t-1}^e * \Delta t)^2 + (\dot{x}_{t-1}^n * \Delta t)^2} + \frac{1}{2} \ddot{x}_{t-1}^A * (\Delta t)^2;$$

(3) the distance from time t-2 to time t-1, computed from the GPS velocity and acceleration from time t-2 to time t-1. This will be used as a calibration factor for both the Vehicle Speed Sensor and the Longitudinal accelerometer:

$$s = \sqrt{(\dot{x}_{t-2}^e * \Delta t)^2 + (\dot{x}_{t-2}^n * \Delta t)^2} + \frac{1}{2} \ddot{x}_{t-1}^A * (\Delta t)^2;$$

(4) the change in heading from time t-2 to time t-1 from the GPS heading computed at those times. This is used as a correction factor for the lateral accelerometer.

$$\Delta\theta = \theta_{t-2} - \theta_{t-1} - \theta_{t-1}^G$$

The use of GPS velocity information for vehicle position propagation in a vehicle navigation system is described in more detail in copending U.S. patent application Ser. No. 08/579,902, entitled "Improved Vehicle Navigation System And Method Using GPS Velocities" and filed concurrently with this application..

Each sensor needs to have calibrations performed on it. The calibrations will be performed using known good data from the GPS receiver 18. The GPS receiver 18 has velocity accuracy to within one meter per second. The GPS velocity information becomes less accurate in low velocity states of less than 1.5 m/s. The GPS velocity information is time tagged so that it matches a particular set of odometer and accelerometer data on a per second basis. Map matching provides correction factors, but they are based on long term trends and not directly associated with any specific time interval. Sensor calibration using the GPS velocities will typically involve the following sensors.

Odometer (Vehicle Speed Sensor) Calibration. The odometer output is the number of ticks of a counter, with a specified number of ticks to be equal to one unit of linear distance traversed. An example is that the GM Vehicle Speed Sensor has 4000 pulses per mile. This will have a default value from the factory and a calibrated value stored in FLASH thereafter. The odometer will be calibrated once per second from the GPS velocity and acceleration that occurred over that same time period, when valid GPS data is available.

Lateral Accelerometer. The lateral accelerometer measures centripetal acceleration. It is used to compute turn angle from the equation: Turn angle in radians is equal to the quotient of centripetal acceleration and tangential velocity. The lateral accelerometer has two values which need to be calibrated: The zero offset and the scale factor. The zero offset is the measurement that the accelerometer outputs when a no acceleration state exists. The scale factor is the number that is multiplied by the difference between the accelerometer read value and the accelerometer zero offset to compute the number of G's of acceleration. The zero motion detect system discussed in FIGS. 5a and 5b will be used to compute the accelerometer zero offset value. The first derivative of the GPS velocities will be used to compute the scale factor calibration.

Longitudinal Accelerometer. The longitudinal accelerometer measures the acceleration along the nose/tail axis of the vehicle, with a positive acceleration being out the nose (forward) and a negative acceleration being out the rear of

12

the vehicle. The longitudinal accelerometer has two values which need to be calibrated: The zero offset and the scale factor. The zero offset is the measurement that the accelerometer outputs when a no acceleration state exists. The scale factor is the number that is multiplied by the difference between the accelerometer read value and the accelerometer zero offset to compute the number of G's of acceleration. The first derivative of the GPS velocities will be used to compute the scale factor calibration. The zero motion detect system shown in FIGS. 5a and 5b will be used to compute the accelerometer zero offset value.

FIG. 5a shows the zero motion detect system with a motion sensor 64 (an orthogonal axes accelerometer in this embodiment) providing motion signals. An amplifier 65 amplifies the motion signals, and in this particular embodiment, the motion signals are digitized in an analog to digital converter 67. The motion signals are provided to a zero motion detection and offset calculation block 69 which is in the application unit 22 (FIG. 2a). The vehicle navigation determines a zero motion state by comparing samples of the motion signals from the motion sensor 64, such as an accelerometer, a gyro, or piezoelectric sensors with a threshold (the threshold is determined by vehicle vibration characteristics for the type of vehicle that the unit is mounted in, or the threshold for motion sensor could be set using other sensors which suggest zero motion, such as odometer, GPS or DGPS). The vehicle navigation system uses at least one of the samples to determine the zero offsets if the zero motion state is detected. At least two samples are preferred to compare over a time interval and averaging those samples to obtain a zero offset for the motion sensor 64. If a zero motion state exists, the vehicle navigation system sets a zero motion flag 71 and uses at least one of the samples to determine the zero offset for the sensor providing the processed motion signals.

The system also provides offset data signals 73 which reflect the zero offset for the sensor providing the motion signals or the raw data used to calculate the zero offset. Upon detecting a zero motion state, the vehicle navigation system can resolve ambiguity of low velocity GPS measurements because the velocity is zero. GPS velocities do not go to zero, so ambiguities exist when in a low velocity state of less than 1.5 m/s. If a zero motion flag is on, then the ambiguities are resolved because the system is not moving. As such, the system freezes the heading and can also set the speed component of velocity to zero.

The following high level language program shows the operation of this particular embodiment of the zero motion detect system.

```

NUMSAMPLES = 16 (in filter array)
WORD          DATA[NUMSAMPLES - 1]
WORD          NOISE
FOR (I = 0; I < NUMSAMPLES; I++)
    NOISE = NOISE + | DATA[I] - DATA[I + 1] |
IF (NOISE > THRESHOLD)
    ZERO_MOTION_FLAG = 0
ELSE
    ZERO_MOTION_FLAG = 1.

```

FIG. 5b shows a flowchart of a variation of the zero motion detect system. At step 75, the system initializes the variables I and NOISE to zero, and at step 77, the first value of the array is read. The counter I is incremented at step 79, and the system reads the next sample at step 81. At step 83, the system begins to accumulate the differences between consecutive samples of the motion signals. The system loops through steps 81-87 until all the samples have been read and

5,862,511

13

the difference between consecutive samples accumulated in the variable NOISE. Once all the samples have been read, the system compares the variable NOISE with the threshold value at step 89. If the NOISE variable is greater than the threshold, then the system determines that motion has been detected in step 91. If the NOISE variable is less than the threshold, the system sets the zero motion flag and determines that the velocity is zero at step 93. The setting of the zero motion flag can set distance changes to zero, lock the heading and current position. Additionally, at step 95, the system calculates the zero offset for the sensor being sampled.

With regard to FIG. 5b and the high level program above, the system is described as sampling the motion signals from one sensor 64, such as one axis of the orthogonal axes accelerometer. In this particular embodiment, the motion signals for each of the orthogonal axes of the accelerometer is sampled and zero offsets for each is determined. Furthermore, zero offsets, sensor calibration or resolving of ambiguities can be accomplished for other sensors using the zero motion detection system according to the principles of the present invention. The use of a zero motion detection system in a vehicle navigation system is described in more detail in copending U.S. patent application Ser. No. 08/579, 903, entitled "Zero Motion Detection System For Improved Vehicle Navigation System" and filed concurrently with this application.

FIGS. 6a and 6b show a general flowchart illustrating how the improved vehicle navigation system 10 propagates a previous position to a current position. At step 150, the improved vehicle navigation system determines if the vehicle is in a zero motion state as described above. If so, the system, at step 152, sets the change in distance to zero, locks the heading and current position, and calibrates the zero offsets.

If the system determines that the vehicle is moving, the system proceeds to step 154 to determine if a GPS solution is available. If GPS is available, the system uses the GPS velocity information to determine the current position. The GPS velocity information is very accurate above velocities of 1.5 m/s because GPS delta ranges are used to calculate the velocities. Using the GPS velocities for position propagation has other advantages. For example, the GPS receiver does not require calibration because of no inherent drift, and the GPS measurements can be used to calibrate other sensors. Moreover, cheaper sensors can be used because there is no need to use the sensors very often, and the sensors can be calibrated very often using the GPS measurements. The GPS receiver supports portability because it is independent of the vehicle and does not require a link to the vehicle odometer and reverse gear.

As shown in step 156, the system calculates east and north accelerations as follows:

$$e\text{-acc}=e\text{-ve1}-\text{last.e-ve1} \quad (1)$$

$$n\text{-acc}=n\text{-ve1}-\text{last.n-ve1} \quad (2).$$

The accelerations are used to calculate east and north displacements as follows:

$$e\text{-dist}=(e\text{-ve1}*\Delta t)+\frac{1}{2}(e\text{-acc}*(\Delta t)^2) \quad (3)$$

$$n\text{-dist}=(n\text{-ve1}*\Delta t)+\frac{1}{2}(n\text{-acc}*(\Delta t)^2) \quad (4).$$

The current position is calculated as follows:

14

$$\text{lat}=\text{lat}+(\text{n-dist} * \text{degrees/meter}) \quad (5)$$

$$\text{long}=\text{long}+(\text{e-dist} * \text{degrees/meter}) \quad (6),$$

where degrees/meter represents a conversion factor of meters to degrees, taking into consideration the shrinking number of meters in a degree of longitude as the distance from the Equator increases. Finally, at step 156, the system calibrates the sensor items, such as the accelerometer scale factors and the odometer distance using information from the equations described above. The system can keep the sensors well calibrated because calibrating can occur once per second (scale factors) if the vehicle speed is above 1.5 m/s.

If a full GPS solution is not available at step 154, the system checks at step 58 whether any GPS measurements are available. If so, the system computes the velocity information from the available subset of delta range measurements at step 160. If, at step 162, the velocity information is good, the system calculates current position using the equations 1-6 at step 164 but without calibrating the acceleration scale factors and the odometer distance in this embodiment. If the GPS velocity is determined not to be good at step 162, the system checks the heading component of the GPS velocity at step 166. If the GPS heading component is determined to be valid, then at step 168, the change in distance is set with the odometer distance, and the heading is set with the GPS heading calculated from the GPS delta range measurements. Alternatively, an odometer is not used, and the distance is derived from the longitudinal acceleration information. With this heading and distance, the system calculates a position (lat, long) at step 170 using the equations as follows:

$$e\text{-dist}=\Delta\text{Dist} * \sin(\text{heading}) \quad (7)$$

$$n\text{-dist}=\Delta\text{Dist} * \cos(\text{heading}) \quad (8).$$

After calculating the east and north distances, the system determines the vehicle position using equations 5 and 6, but calibration is not performed at this point in this embodiment.

If the system determines at step 166 that the GPS heading is not valid (GPS blockage or low velocity) or at step 158 that the GPS measurements are insufficient, the system falls back on the orthogonal axes accelerometer(s) and the odometer in this particular embodiment. GPS velocity information is subject to errors at speeds of less than 1.5 m/s, unless using a more accurate GPS system. For example, in a vehicle navigation system using DGPS, the threshold velocity is lower because of the higher accuracy of the system. As such, the vehicle navigation system proceeds to step 172 to determine the change in distance using lateral and longitudinal acceleration information from the orthogonal axes accelerometer(s). At step 174, the system compares the longitudinal distance from the accelerometer with the odometer distance, and if the difference between them exceeds a threshold value, the odometer distance is used at step 176. If the difference is less than the threshold, then the accelerometer distance or the odometer distance can be used for the distance at step 178. According to some aspects of the present invention, the system could fall back on only the orthogonal axes accelerometer(s). As shown in dashed step 173, if an odometer is not used, the distance is derived from the longitudinal acceleration information. Once the change in distance is determined, the system calculates the position at step 180 using the following equations to determine heading as follows:

5,862,511

15

$$\text{speed} = \Delta \text{Dist} / \Delta t \quad (9)$$

$$\Delta \theta = a_{lat} \text{ (lateral acceleration) / longitudinal speed} \quad (10)$$

$$\text{heading} = \text{heading} + \Delta \theta (\text{modulo } 360^\circ) \quad (11).$$

After determining heading, the system uses equations 7 and 8 to determine the east and north distances and equations 5 and 6 to determine position.

The use of multiple, orthogonal axes acceleration information to propagate a vehicle position from a previous position to a current position is described in more detail in copending U.S. patent application Ser. No. **08/580,177**, entitled "Improved Vehicle Navigation System And Method Using A Multiple Axes Accelerometer" and filed concurrently with this application.

After determining the initial current position at step **156**, **164**, **170** or **180**, the system proceeds to step **182** where the current position is compared with the GPS position. If the current position is within an acceptable distance (within 100 m for example) from the GPS position, the system determines that the current position is valid at step **184**. If not, the system replaces the current position with the GPS position at step **186**. At this point, the system sends to a map matching step **188** a position and velocity, which has speed and heading components. Depending on the configuration of the map database **30**, other information can be sent to the map matching block **188**, such as heading and distance based on the current and previous positions, a current position and figures of merit (FOM) for each.

The map matching block **188** sends back a map matched current position, distance, heading, FOMs for each and calibration data. In this embodiment, the map matching block **188** interrogates the map database **30** (FIG. **2a**) to obtain a heading of the mapped path segment which the vehicle is determined to be traversing. The map matching block **188** updates the heading associated with the current position, which was based on GPS and/or sensor calculations, to obtain an updated current position. As such, the map matching block **188** uses the map heading to update the heading based on the GPS velocity information, the heading based on the GPS position information of step **186**, the heading from the sensors, or the heading based on a current position determined through a combination of GPS and sensor information, such as an embodiment with all raw inputs going into a Kalman filter.

As shown in FIG. **7a**, the vehicle navigation system **10** (FIG. **2a**) uses GPS velocity information to propagate a previous position **191** to a current position **192** (by adding displacements **194** and **196** obtained from the velocity information (integrated) to the previous position). In FIG. **7b**, if GPS information is not available, the vehicle navigation system uses sensor information to propagate the previous position **191** to current position **192** using heading and distance **198**. If the difference between the GPS heading (or current heading from the sensors if GPS is not used) and the map heading is within a threshold, then the map heading is used as the heading for position propagation. The vehicle navigation system **10** can accomplish this in alternative ways. For example, as shown in FIG. **7c** using GPS velocities, the vehicle navigation system **10** rotates the GPS velocity vector **200** to align with the map heading **202** if the GPS and map headings are within the threshold and integrates the rotated GPS velocity vector **204** to obtain the displacements **208** and **210**. As shown, the updated current position **206** is obtained by applying orthogonal displacements **208** and **210** to the previous position **191**.

Errors usually involve heading determinations due to drift errors in gyro or compass. Displacement is easy to test and

16

one of the most accurate components in the GPS measurements and also in the sensors, so the system uses the entire displacements from the GPS velocity information or the dead reckoning sensors, such as the accelerometers. Thus, the improved vehicle navigation system can use low cost sensors which are less sensitive because heading can be corrected with map heading.

As shown in FIG. **7d**, if the vehicle navigation system uses sensor information to propagate the previous position **191** to current position **192** using heading and distance **198**, the map heading **202** can be used as the heading for position propagation to the updated current position **206**. FIG. **7e** shows an alternative way of updating the GPS heading and thus the current position by projecting the velocity vector **200** to align with the map heading **202** and integrating the projected velocity **212** to obtain displacements **214** and **216**. The system **10** obtains the updated current position **192** by applying the displacements **214** and **216** to the previous position **191**. The use of map heading to update the information obtained from the non-GPS sensors or a combination of GPS and other sensors can be accomplished in a similar manner as would be understood by one of skill in the art. Depending on the information available and the particular embodiment, the improved vehicle navigation system can react differently to the information provided by the map matching block **188**.

The improved vehicle navigation system will rely heavily on the GPS information for positioning and a high frequency of sensor calibration because GPS information is available a great deal of the time. When GPS is available, the improved vehicle navigation system can use the map matching block **188** to provide an overall check on the current position and to provide position and heading correction data which is used if map matching **188** determines it is highly reliable. In this particular embodiment, the current position (w/o map matching) is determined once per second. If the vehicle has travelled more than 15 meters since the last call to map matching **188**, then the current position is passed to map matching **188**. If the vehicle is travelling at high speed, the system will go to map matching **88** at each current position determination at the maximum rate of once per second. When GPS is not available or unreliable, the improved vehicle navigation system has well calibrated sensors to rely on, and the improved vehicle navigation system can rely more on the information from the map matching block **188** for positioning and sensor calibration.

Thus, the improved vehicle navigation system provides several significant advantages, such as flexibility, modularity, and accuracy at a cheaper cost because GPS information can be used to calibrate sensors more often and updating can be performed at a complete stop. These advantages occur because the system relies heavily on GPS velocity information to propagate vehicle position. The GPS velocity information is more reliable (within about 1 m/s) than the GPS position data (within about 100 m). Position data from GPS velocity information propagated positions is smoother than GPS position data which is not accurate enough by itself for turn-by-turn vehicle position propagation.

The principles of the present invention, which have been disclosed by way of the above examples and discussion, can be implemented using various navigation system configurations and sensors. The improved vehicle navigation system, for instance, can be implemented without using an odometer connection and obtaining distance information from the accelerometer inputs when GPS is not available to improve portability and installation costs. Moreover, the

5,862,511

17

improved vehicle navigation system can obtain dead reckoning information from GPS signals when a full set of GPS measurements is available, and use its sensors when anything less than a full set of GPS signals is available. Those skilled in the art will readily recognize that these and various other modifications and changes may be made to the present invention without strictly following the exemplary application illustrated and described herein and without departing from the true spirit and scope of the present invention, which is set forth in the following claims.

We claim:

1. An improved vehicle navigation system comprising:
 - a map database with map information, said vehicle navigation system derives a map heading from said map information; and
 - a GPS receiver which provides GPS velocity information including a heading, said vehicle navigation system uses said velocity information to propagate a previous position to a current position and interrogates said map database to obtain said map heading information; said vehicle navigation system updates said velocity information with said map heading for propagating said previous position to said current position if the difference between the heading of said velocity information and said map heading are within a threshold, wherein said system rotates said velocity to align with said map heading and integrates the rotated velocity to obtain displacements; said system obtains said current position by applying said displacements to said previous position.
2. An improved vehicle navigation system comprising:
 - a map database with map information, said vehicle navigation system derives a map heading from said map information; and
 - a GPS receiver which provides GPS velocity information including a heading, said vehicle navigation system uses said velocity information to propagate a previous position to a current position and interrogates said map database to obtain said map heading information; said vehicle navigation system updates said velocity information with said map heading for propagating said previous position to said current position if the difference between the heading of said velocity information and said map heading are within a threshold, wherein said system projects said velocity onto said map heading and integrating said projected velocity to obtain a displacement and obtaining said current position by applying said displacement to said previous position.
3. A method of estimating the velocity of a vehicle known to be on a mapped path comprising:
 - determining the velocity of the vehicle, the velocity including a heading;
 - interrogating a map database to obtain a map heading of said mapped path; and
 - updating said velocity with said map heading if the difference between the heading of said velocity and said map heading are within a threshold;
 - using said velocity to propagate a previous position to a current position, wherein said step of using includes rotating velocity to align with said map heading and integrating rotated velocity to obtain a displacement and obtaining said current position by applying said displacement to said previous position.
4. A method of estimating the velocity of a vehicle known to be on a mapped path comprising:
 - determining the velocity of the vehicle, the velocity including a heading;

18

interrogating a map database to obtain a map heading of said mapped path;

updating said velocity with said map heading if the difference between the heading of said velocity and said map heading are within a threshold; and

using said velocity to propagate a previous position to a current position, wherein said step of using includes projecting said velocity to align with said map heading and integrating said projected velocity to obtain a displacement and obtaining said current position by applying said displacement to said previous position.

5. An improved vehicle navigation system, comprising an orthogonal axes accelerometer which provides longitudinal and lateral acceleration information and a GPS receiver which provides GPS velocity information, said vehicle navigation system uses said lateral acceleration information to derive heading change; said vehicle navigation system uses said heading change to propagate a previous position to a current position: said vehicle navigation system uses said GPS velocity information to propagate said previous position to said current position if GPS velocity information is used; said vehicle navigation system determines lateral and longitudinal calibration information from said GPS velocity information to calibrate said orthogonal axes accelerometer.

6. An improved vehicle navigation system, comprising:

- a GPS receiver which provides GPS velocity information, said vehicle navigation system uses said GPS velocity information to propagate a previous position to a current position;

an orthogonal axes accelerometer provides longitudinal and lateral acceleration information, said vehicle navigation system determines lateral and longitudinal calibration information from said GPS velocity information to calibrate said orthogonal axes accelerometer, said vehicle navigation system determines heading change using said lateral acceleration information; and said vehicle navigation system uses said heading change to propagate a previous position to a current position if said GPS velocity information is not used.

7. The system of claim 6 wherein said system uses said longitudinal acceleration information and said heading change to propagate a previous position to a current position if said GPS velocity information is not used.

8. A method of propagating a previous position to a current position in a position determination system, said method including the steps of:

providing longitudinal acceleration information from an orthogonal axes accelerometer;

providing lateral acceleration information from said orthogonal axes accelerometer;

determining longitudinal speed from said longitudinal acceleration information;

deriving heading change from said lateral acceleration information and said longitudinal speed;

using said heading change and said longitudinal acceleration to propagate a previous position to a current position

providing GPS velocities;

determining lateral and longitudinal calibration information from said GPS velocities; and

calibrating said orthogonal axes accelerometer with said lateral and longitudinal calibration information.

9. The method of claim 8 further including the steps of:

- updating scale factors for said orthogonal axes accelerometer using said lateral and longitudinal calibration information.

5,862,511

19

10. An improved vehicle navigation system, comprising:
 a GPS receiver which provides GPS velocity information,
 said vehicle navigation system uses said GPS velocity
 information to propagate a previous position to a current
 position; and
 5 an orthogonal axes accelerometer provides motion signals
 having longitudinal and lateral acceleration information
 and zero offsets, said vehicle navigation system
 determines heading change using said lateral accelera-
 tion information; said vehicle navigation system uses
 said heading change to propagate a previous position to
 a current position if said GPS velocity information is
 not used, said vehicle navigation system compares said
 motion signals with a threshold to determine a zero
 motion state, and if said vehicle navigation system is in
 said zero motion state, said vehicle navigation system
 determines said zero offsets.
 11. An improved vehicle navigation system, comprising:
 a GPS receiver which provides GPS velocity information,
 said vehicle navigation system uses said GPS velocity
 information to propagate a previous position to a current
 position; and
 20 an orthogonal axes accelerometer provides motion signals
 having longitudinal and lateral acceleration information
 and zero offsets, said vehicle navigation system
 determines heading change using said lateral accelera-
 tion information; said vehicle navigation system uses
 said heading change to propagate a previous position to
 a current position if said GPS velocity information is
 not used, said vehicle navigation system comparing
 said motion signals with a threshold to determine a zero
 motion state, and said vehicle navigation system locks
 heading changes and calibrates said zero offsets if said
 vehicle navigation system is in said zero motion state.
 12. An improved vehicle navigation system, comprising:
 a GPS receiver which provides GPS velocity information,
 said vehicle navigation system uses said GPS velocity
 information to propagate a previous position to a current
 position;
 35 an orthogonal axes accelerometer provides motion signals
 having longitudinal and lateral acceleration informa-
 tion and zero offsets, including longitudinal and lateral
 acceleration information, said vehicle navigation sys-
 tem determines heading change using said lateral accelera-
 tion information and longitudinal speed; said
 vehicle navigation system uses said heading change to
 propagate a previous position to a current position if
 said GPS velocity information is not used, said vehicle
 navigation system comparing said motion signals with
 a threshold to determine a zero motion state, and said
 vehicle navigation system locks heading changes and
 calibrates said zero offsets of said orthogonal axes
 accelerometer if said vehicle navigation system is in
 said zero motion state;
 40 an odometer provides displacement information, said
 vehicle navigation system determines displacement
 using at least one of said longitudinal acceleration
 information and said displacement information, said
 vehicle navigation system determines heading change
 from said lateral acceleration information, said vehicle
 navigation system determines odometer calibration
 information from said GPS velocity information if said
 GPS velocity information is used, said vehicle naviga-
 tion system uses said heading change and said displace-
 ment to propagate a previous position to a current
 position if said GPS velocity information is not used;
 65 and

20

a map database which stores map information, said
 vehicle navigation system determines a heading from
 said map information, said vehicle navigation system
 updates said GPS velocity information with said head-
 ing before propagating said previous position to a
 current position.
 13. An improved vehicle navigation system, comprising:
 a GPS receiver which provides GPS velocity information,
 said vehicle navigation system uses said GPS velocity
 information to propagate a previous position to a current
 position;
 an orthogonal axes accelerometer provides longitudinal
 and lateral acceleration information, said vehicle naviga-
 tion system determines lateral and longitudinal calibra-
 tion information from said GPS velocity informa-
 tion to calibrate said orthogonal axes accelerometer if
 said GPS velocity information is used; and
 an odometer provides displacement information, said
 vehicle navigation system determines displacement
 using at least one of said longitudinal acceleration
 information and said displacement information; said
 vehicle navigation system determines heading change
 using said lateral acceleration information; said vehicle
 navigation system uses said heading change and said
 displacement to propagate a previous position to a
 current position if said GPS velocity information is not
 used; and
 a map database which stores map information, said
 vehicle navigation system determines a map heading
 from said map information, said vehicle navigation
 system updates said GPS velocity information with
 said map heading before propagating said previous
 position to a current position if the difference between
 said map heading and the heading of said GPS velocity
 information is within a threshold.
 14. The system of claim 13 wherein said system deter-
 mines heading change using said longitudinal acceleration
 information.
 15. An improved vehicle navigation system, comprising:
 a GPS receiver which provides which provides GPS delta
 range information and GPS velocity information calcu-
 lated from a set of said GPS delta range information,
 said vehicle navigation system uses said GPS velocity
 information when said set of GPS delta range informa-
 tion is available and calculates GPS velocity informa-
 tion from a subset of said GPS delta range information
 when said set of GPS delta range information is not
 available and uses said GPS velocity information to
 propagate a previous position to a current position;
 an orthogonal axes accelerometer provides motion signals
 having longitudinal and lateral acceleration informa-
 tion and zero offsets, said vehicle navigation system
 determines heading change using said lateral accelera-
 tion information; said vehicle navigation system uses
 said heading change to propagate a previous position to
 a current position if said GPS velocity information is
 not used, said vehicle navigation system comparing
 said motion signals with a threshold to determine a zero
 motion state, and said vehicle navigation system locks
 heading changes and calibrates said zero offsets if said
 vehicle navigation system is in said zero motion state;
 and
 a map database which stores map information, said
 vehicle navigation system determines a map heading
 from said map information, said vehicle navigation
 system updates said GPS velocity information with

21

said map heading before propagating said previous position to a current position if the difference between the heading of said GPS velocity information and said map heading is within a threshold.

- 16. An improved vehicle navigation system, comprising:
 - 5 a GPS receiver which provides GPS velocity information, said vehicle navigation system uses said GPS velocity information to propagate a previous position to a current position;
 - 10 an orthogonal axes accelerometer provides longitudinal and lateral acceleration information, said vehicle navigation system determines heading change using said lateral acceleration information; said vehicle navigation system uses said heading change to propagate a previous position to a current position if said GPS velocity information is not used, said vehicle navigation system determines latitudinal and longitudinal calibration information from said GPS velocity information to calibrate said orthogonal axes accelerometer;
 - 15 an odometer provides displacement information, said vehicle navigation system determines displacement using at least one of said longitudinal acceleration information and said displacement information; said vehicle navigation system determines heading change using said lateral acceleration information; said vehicle navigation system uses said heading change and said displacement to propagate a previous position to a current position if said GPS velocity information is not used, said vehicle navigation system determines odometer calibration information from said GPS velocity information if said GPS velocity information is used to calibrate said odometer; and
 - 20 a map database which stores map information, said vehicle navigation system determines a map heading from said map information, said vehicle navigation system updates said GPS velocity information with
 - 25
 - 30
 - 35

22

said map heading if the difference between the GPS heading and said map heading are within a threshold before propagating said previous position to a current position.

- 17. An improved vehicle navigation system, comprising:
 - a GPS receiver which provides GPS velocity information, said vehicle navigation system uses said GPS velocity information to propagate a previous position to a current position;
 - an orthogonal axes accelerometer provides motion signals having longitudinal and lateral acceleration information and zero offsets, said vehicle navigation system determines heading change using said lateral acceleration information; said vehicle navigation system uses said heading change to propagate a previous position to a current position if said GPS velocity information is not used, said vehicle navigation system comparing said motion signals with a threshold to determine a zero motion state, and said vehicle navigation system locks heading changes and calibrates said zero offsets if said vehicle navigation system is in said zero motion state, said vehicle navigation system determines lateral and longitudinal calibration information from said GPS velocity information to calibrate said orthogonal axes accelerometer if said GPS velocity information is used if said vehicle navigation is not in said zero motion state; and
 - a map database which stores map information, said vehicle navigation system determines a map heading from said map information, said vehicle navigation system updates said GPS velocity information with said map heading if the difference between the heading of said GPS velocity information and said map heading is within a threshold before propagating said previous position to a current position.

* * * * *



US005862511C1

(12) **EX PARTE REEXAMINATION CERTIFICATE** (9315th)
United States Patent
Croyle et al.

(10) **Number:** **US 5,862,511 C1**
(45) **Certificate Issued:** **Sep. 25, 2012**

- (54) **VEHICLE NAVIGATION SYSTEM AND METHOD**
- (75) Inventors: **Steven R. Croyle**, Franklin, MI (US);
Larry E. Spencer, II, Lake Orion, MI (US);
Ernie R. Sittaro, Romeo, MI (US)
- (73) Assignee: **Beacon Navigation GmbH**, Zug (CH)

Primary Examiner—Adam Basehoar

(57) **ABSTRACT**

The improved vehicle navigation system and method uses information from a Global Positioning System (GPS) to obtain velocity vectors, which include speed and heading components, for “dead reckoning” the vehicle position from a previous position. If information from the GPS is not available, then the improved vehicle navigation system uses information from an orthogonal axes accelerometer, such as two or three orthogonally positioned accelerometers, to propagate vehicle position. Because the GPS information should almost always be available, the improved vehicle navigation system relies less on its accelerometers, thereby allowing the use of the less expensive accelerometers. The improved vehicle navigation system retains the accuracy of the accelerometers by repeatedly calibrating them with the velocity data obtained from the GPS information. The improved vehicle navigation system calibrates the sensors whenever GPS data is available (for example, once a second at relatively high speeds). Furthermore, the improved vehicle navigation system does not need to rely on map matching to calibrate sensors. System flexibility is improved because map matching is oblivious to the hardware, and the system hardware can be updated without affecting map matching or a change in the map database.

Reexamination Request:
 No. 90/012,109, Jan. 27, 2012

Reexamination Certificate for:
 Patent No.: **5,862,511**
 Issued: **Jan. 19, 1999**
 Appl. No.: **08/580,150**
 Filed: **Dec. 28, 1995**

- (51) **Int. Cl.**
G01C 21/30 (2006.01)
G01C 21/28 (2006.01)
G01S 5/14 (2006.01)
 G01S 11/10; G01S 11/00
- (52) **U.S. Cl.** **701/445; 701/474; 701/500;**
 73/178 R
- (58) **Field of Classification Search** None
 See application file for complete search history.

(56) **References Cited**
 To view the complete listing of prior art documents cited during the proceeding for Reexamination Control Number 90/012,109, please refer to the USPTO’s public Patent Application Information Retrieval (PAIR) system under the Display References tab.

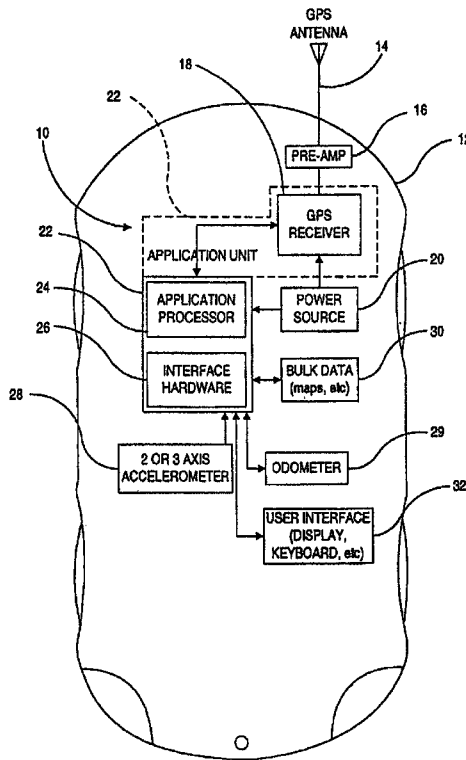

US 5,862,511 C1

1
EX PARTE
REEXAMINATION CERTIFICATE
ISSUED UNDER 35 U.S.C. 307

NO AMENDMENTS HAVE BEEN MADE TO
THE PATENT

2
AS A RESULT OF REEXAMINATION, IT HAS BEEN
DETERMINED THAT:

The patentability of claims **1** and **3** is confirmed.
5 Claims **2** and **4-17** were not reexamined.

* * * * *



US005862511C2

(12) **EX PARTE REEXAMINATION CERTIFICATE** (10212th)

United States Patent

Croyle et al.

(10) **Number:** **US 5,862,511 C2**

(45) **Certificate Issued:** **Jun. 27, 2014**

(54) **VEHICLE NAVIGATION SYSTEM AND METHOD**

(75) Inventors: **Steven R. Croyle**, Franklin, MI (US);
Larry E. Spencer, II, Lake Orion, MI (US);
Ernie R. Sittaro, Romeo, MI (US)

(73) Assignee: **Beacon Navigation GmbH**, Zug (CH)

Reexamination Request:
No. 90/012,743, Dec. 17, 2012

Reexamination Certificate for:
Patent No.: **5,862,511**
Issued: **Jan. 19, 1999**
Appl. No.: **08/580,150**
Filed: **Dec. 28, 1995**

Reexamination Certificate C1 5,862,511 issued Sep. 25, 2012

- (51) **Int. Cl.**
G01C 21/30 (2006.01)
G01C 21/28 (2006.01)
G01S 5/14 (2006.01)
G01S 11/10 (2006.01)
G01S 11/00 (2006.01)
- (52) **U.S. Cl.**
USPC **701/445**; 701/474; 701/500; 73/178 R
- (58) **Field of Classification Search**
None
See application file for complete search history.

(56) **References Cited**

To view the complete listing of prior art documents cited during the proceeding for Reexamination Control Number 90/012,743, please refer to the USPTO's public Patent Application Information Retrieval (PAIR) system under the Display References tab.

Primary Examiner — Joshua Campbell

(57) **ABSTRACT**

The improved vehicle navigation system and method uses information from a Global Positioning System (GPS) to obtain velocity vectors, which include speed and heading components, for "dead reckoning" the vehicle position from a previous position. If information from the GPS is not available, then the improved vehicle navigation system uses information from an orthogonal axes accelerometer, such as two or three orthogonally positioned accelerometers, to propagate vehicle position. Because the GPS information should almost always be available, the improved vehicle navigation system relies less on its accelerometers, thereby allowing the use of the less expensive accelerometers. The improved vehicle navigation system retains the accuracy of the accelerometers by repeatedly calibrating them with the velocity data obtained from the GPS information. The improved vehicle navigation system calibrates the sensors whenever GPS data is available (for example, once a second at relatively high speeds). Furthermore, the improved vehicle navigation system does not need to rely on map matching to calibrate sensors. System flexibility is improved because map matching is oblivious to the hardware, and the system hardware can be updated without affecting map matching or a change in the map database.

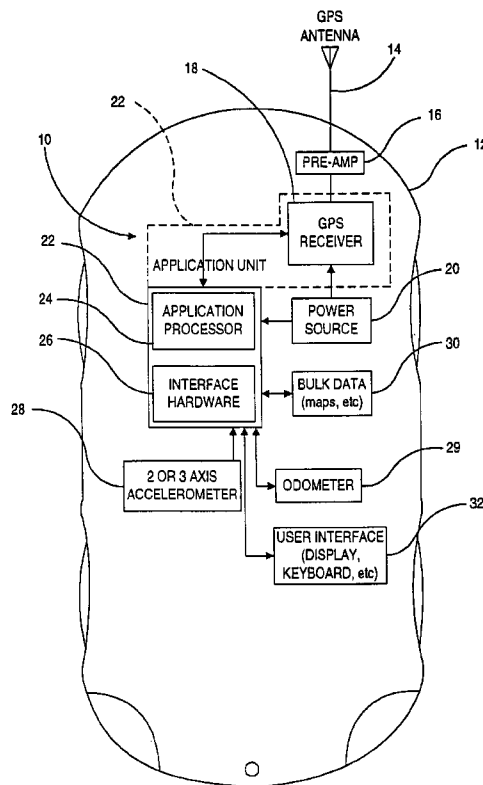

US 5,862,511 C2

1

2

**EX PARTE
REEXAMINATION CERTIFICATE
ISSUED UNDER 35 U.S.C. 307**

5

NO AMENDMENTS HAVE BEEN MADE TO
THE PATENT

AS A RESULT OF REEXAMINATION, IT HAS BEEN
DETERMINED THAT:

10

The patentability of claims 1 and 3 is confirmed.
Claims 2 and 4-17 were not reexamined.

* * * * *



US005862511C3

(12) **EX PARTE REEXAMINATION CERTIFICATE** (10993rd)
United States Patent
Croyle et al.

(10) **Number:** **US 5,862,511 C3**
 (45) **Certificate Issued:** **Nov. 23, 2016**

(54) **VEHICLE NAVIGATION SYSTEM AND METHOD**

(75) Inventors: **Steven R. Croyle**, Franklin, MI (US);
Larry E. Spencer, II, Lake Orion, MI (US);
Ernie R. Sittaro, Romeo, MI (US)

(73) Assignee: **BEACON NAVIGATION GMBH**, Zug (CH)

(58) **Field of Classification Search**

None
 See application file for complete search history.

(56) **References Cited**

To view the complete listing of prior art documents cited during the proceeding for Reexamination Control Number 90/013,732, please refer to the USPTO's public Patent Application Information Retrieval (PAIR) system under the Display References tab.

Primary Examiner — Jalatee Worjloh

Reexamination Request:

No. 90/013,732, Apr. 20, 2016

Reexamination Certificate for:

Patent No.: **5,862,511**
 Issued: **Jun. 19, 1999**
 Appl. No.: **08/580,150**
 Filed: **Dec. 28, 1995**

Reexamination Certificate C1 5,862,511 issued Sep. 25, 2012

Reexamination Certificate C2 5,862,511 issued Jun. 27, 2014

(57) **ABSTRACT**

The improved vehicle navigation system and method uses information from a Global Positioning System (GPS) to obtain velocity vectors, which include speed and heading components, for "dead reckoning" the vehicle position from a previous position. If information from the GPS is not available, then the improved vehicle navigation system uses information from an orthogonal axes accelerometer, such as two or three orthogonally positioned accelerometers, to propagate vehicle position. Because the GPS information should almost always be available, the improved vehicle navigation system relies less on its accelerometers, thereby allowing the use of the less expensive accelerometers. The improved vehicle navigation system retains the accuracy of the accelerometers by repeatedly calibrating them with the velocity data obtained from the GPS information. The improved vehicle navigation system calibrates the sensors whenever GPS data is available (for example, once a second at relatively high speeds). Furthermore, the improved vehicle navigation system does not need to rely on map matching to calibrate sensors. System flexibility is improved because map matching is oblivious to the hardware, and the system hardware can be updated without affecting map matching or a change in the map database.

(51) **Int. Cl.**

G01C 21/30 (2006.01)
G01C 21/28 (2006.01)
G01S 5/14 (2006.01)
G01S 11/10 (2006.01)
G01S 11/00 (2006.01)
G01S 19/52 (2010.01)
G01S 19/47 (2010.01)

(52) **U.S. Cl.**

CPC **G01C 21/28** (2013.01); **G01S 19/52** (2013.01); **G01C 21/30** (2013.01); **G01S 11/10** (2013.01); **G01S 19/47** (2013.01)

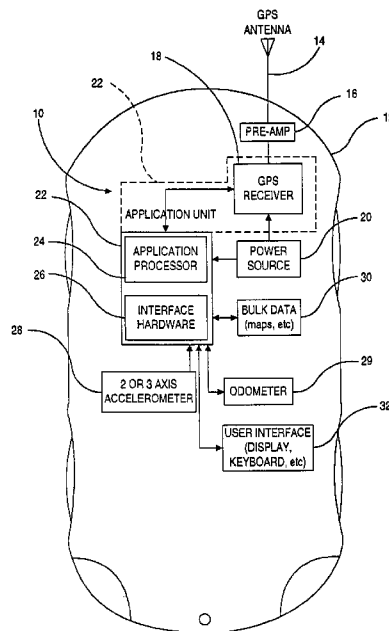

US 5,862,511 C3

1

2

**EX PARTE
REEXAMINATION CERTIFICATE**

NO AMENDMENTS HAVE BEEN MADE TO 5
THE PATENT

AS A RESULT OF REEXAMINATION, IT HAS BEEN
DETERMINED THAT:

The patentability of claims 1 and 3 is confirmed. 10
Claims 2 and 4-17 were not reexamined.

* * * * *



US005862511C4

(12) **EX PARTE REEXAMINATION CERTIFICATE** (11924th)

United States Patent
Croyle et al.

(10) **Number:** **US 5,862,511 C4**
 (45) **Certificate Issued:** **Oct. 12, 2021**

(54) **VEHICLE NAVIGATION SYSTEM AND METHOD**

(75) Inventors: **Steven R. Croyle**, Franklin, MI (US);
Larry E. Spencer, II, Lake Orion, MI (US);
Ernie R. Sittaro, Romeo, MI (US)

(73) Assignee: **BEACON NAVIGATION GMBH**, Zug (CH)

Reexamination Request:

No. 90/014,170, Jul. 18, 2018
 No. 90/014,202, Sep. 17, 2018

Reexamination Certificate for:

Patent No.: **5,862,511**
 Issued: **Jan. 19, 1999**
 Appl. No.: **08/580,150**
 Filed: **Dec. 28, 1995**

Reexamination Certificate C1 5,862,511 issued Sep. 25, 2012

Reexamination Certificate C2 5,862,511 issued Jun. 27, 2014

Reexamination Certificate C3 5,862,511 issued Nov. 23, 2016

(51) **Int. Cl.**

G06G 7/48 (2006.01)
G01C 21/30 (2006.01)
G01S 19/52 (2010.01)
G01C 21/28 (2006.01)
G01S 11/10 (2006.01)

(52) **U.S. Cl.**

CPC **G01C 21/30** (2013.01); **G01C 21/28** (2013.01); **G01S 19/52** (2013.01); **G01S 11/10** (2013.01)

(58) **Field of Classification Search**

None
 See application file for complete search history.

(56) **References Cited**

To view the complete listing of prior art documents cited during the proceedings for Reexamination Control Numbers 90/014,170 and 90/014,202, please refer to the USPTO's public Patent Application Information Retrieval (PAIR) system under the Display References tab.

Primary Examiner — Nick Corsaro

(57) **ABSTRACT**

The improved vehicle navigation system and method uses information from a Global Positioning System (GPS) to obtain velocity vectors, which include speed and heading components, for "dead reckoning" the vehicle position from a previous position. If information from the GPS is not available, then the improved vehicle navigation system uses information from an orthogonal axes accelerometer, such as two or three orthogonally positioned accelerometers, to propagate vehicle position. Because the GPS information should almost always be available, the improved vehicle navigation system relies less on its accelerometers, thereby allowing the use of less expensive accelerometers. The improved vehicle navigation system retains the accuracy of the accelerometers by repeatedly calibrating them with the velocity data obtained from the GPS information. The improved vehicle navigation system calibrates the sensors whenever GPS data is available (for example, once a second at relatively high speeds). Furthermore, the improved vehicle navigation system does not need to rely on map matching to calibrate sensors. System flexibility is improved because map matching is oblivious to the hardware, and the system hardware can be updated without affecting map matching or a change in the map database.

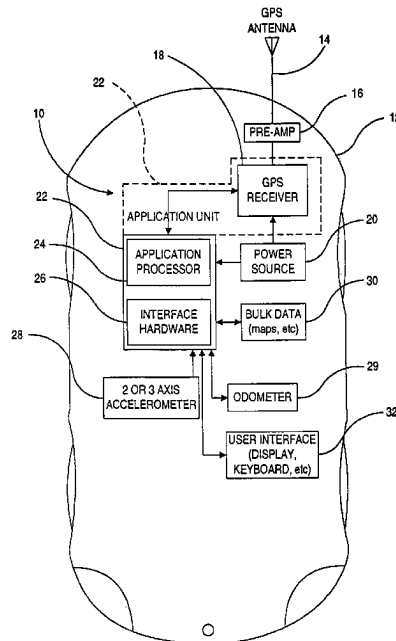

US 5,862,511 C4

1

2

**EX PARTE
REEXAMINATION CERTIFICATE**

NO AMENDMENTS HAVE BEEN MADE TO 5
THE PATENT

AS A RESULT OF REEXAMINATION, IT HAS BEEN
DETERMINED THAT:

The patentability of claims 1 and 3 is confirmed. 10
Claims 2 and 4-17 were not reexamined.

* * * * *