

**IN THE UNITED STATES DISTRICT COURT  
FOR THE EASTERN DISTRICT OF TEXAS  
SHERMAN DIVISION**

FREEDOM PATENTS LLC,

Plaintiff,

v.

TCL ELECTRONICS HOLDINGS  
LIMITED F/K/A TCL MULTIMEDIA  
TECHNOLOGY HOLDINGS, LTD., TCL  
TECHNOLOGY GROUP CORPORATION  
F/K/A TCL CORP., TCL KING  
ELECTRICAL APPLIANCES (HUIZHOU)  
COMPANY LIMITED, TCL MOKA  
INTERNATIONAL LIMITED, TCL  
SMART DEVICE (VIETNAM) CO., LTD.,  
TCT MOBILE INTERNATIONAL  
LIMITED, and HUIZHOU TCL MOBILE  
COMMUNICATION CO., LTD.,

Defendants.

CIVIL ACTION NO. 4:23-cv-420

ORIGINAL COMPLAINT FOR  
PATENT INFRINGEMENT

**JURY TRIAL DEMANDED**

**ORIGINAL COMPLAINT FOR PATENT INFRINGEMENT**

Plaintiff Freedom Patents LLC (“Freedom Patents” or “Plaintiff”) files this original complaint against Defendants TCL Electronics Holdings Limited f/k/a TCL Multimedia Technology Holdings, Ltd., TCL Technology Group Corporation f/k/a TCL Corp., TCL King Electrical Appliances (Huizhou) Company Limited, TCL MOKA International Limited, TCL Smart Device (Vietnam) Co., Ltd., TCT Mobile International Limited, and Huizhou TCL Mobile Communication Co., Ltd. (collectively, “TCL”), alleging, based on its own knowledge as to itself and its own actions and based on information and belief as to all other matters, as follows:

## PARTIES

1. Freedom Patents is a limited liability company formed under the laws of the State of Texas, with its principal place of business at 2325 Oak Alley, Tyler, Texas, 75703.

2. Defendant TCL Electronics Holdings Limited f/k/a TCL Multimedia Technology Holdings, Ltd. (“TCL Electronics”) is a limited liability company duly organized and existing under the laws of the Cayman Islands. It has a place of business at 5th Floor, Building 22E, 22 Science Park East Avenue, Hong Kong Science Park, Shatin, New Territories, Hong Kong SAR, China. TCL Electronics may also be served with process by serving the Texas Secretary of State, 1019 Brazos Street, Austin, Texas 78701, as its agent for service because it engages in business in Texas but has not designated or maintained a resident agent for service of process in Texas as required by statute. This action arises out of that business.

3. TCL Electronics—together with its affiliates—describes itself as “world-leading consumer electronics company that covers display, innovative and internet businesses.”<sup>1</sup> “TCL is a leading global tech brand in display panels, TVs, home comfort and mobile devices,” and “operates its manufacturing and R&D centers worldwide and has products and services in 160+ countries.”<sup>2</sup> According to its Annual Report, the TCL “Group actively transforms and innovates under the strategy of ‘Value Led by Brand with Relative Cost Advantage’ with technology as basis.”<sup>3</sup> In 2022, “the Group saw its global shipment of TCL smart screens increased against the trend, reaching 23.78 million sets, propelling the Group’s market share to rank second

---

<sup>1</sup> TCL Electronics Holdings Limited Annual Report 2022, at 3, <https://doc.irasia.com/listco/hk/tclelectronics/annual/2022/ar2022.pdf>.

<sup>2</sup> See [www.tcl.com/global/en/about-tcl](http://www.tcl.com/global/en/about-tcl).

<sup>3</sup> See *supra* note 1 at 3.

globally.”<sup>4</sup> TCL Electronics is a wholly owned subsidiary of TCL Industries Holdings Co., Ltd., which is “the ultimate holding company of [TCL].”<sup>5</sup>

4. Defendant TCL Technology Group Corporation f/k/a TCL Corp. (“TCL Technology”) is a corporation duly organized and existing under the laws of the People’s Republic of China. TCL Technology has a place of business at No. 17, Huifeng Third Road, Zhongkai High-tech Zone, Huizhou, Guangdong, China 516006. TCL Technology may also be served with process by serving the Texas Secretary of State, 1019 Brazos Street, Austin, Texas 78701, as its agent for service because it engages in business in Texas but has not designated or maintained a resident agent for service of process in Texas as required by statute. This action arises out of that business.

5. TCL Technology’s “key management” are the “major shareholders” of TCL Industries Holdings Co., Ltd.<sup>6</sup> Thus, according to TCL’s annual report, TCL Technology “remains a related party of the Group.”<sup>7</sup> TCL Technology and its subsidiaries are involved in research, development, manufacturing, and distribution of electronic products, including TVs and TV components.

6. Defendant TCL King Electrical Appliances (Huizhou) Company Limited (“TCL King”) is a limited liability company duly organized and existing under the laws of the People’s Republic of China. It has a place of business at No. 78, Huifeng 4 Road, Zhongkai Development Zone Huizhou, 516006, China. TCL King may also be served with process by serving the Texas Secretary of State, 1019 Brazos Street, Austin, Texas 78701, as its agent for service because it

---

<sup>4</sup> See *supra* note 3 at 13.

<sup>5</sup> See *supra* note 4 at 138.

<sup>6</sup> *Id.*

<sup>7</sup> *Id.*

engages in business in Texas but has not designated or maintained a resident agent for service of process in Texas as required by statute. This action arises out of that business.

7. TCL King is a wholly owned subsidiary of TCL Industries Holdings Co., Ltd., which is part of the TCL group of companies and its ultimate holding company. TCL King (Huizhou) is involved in the manufacture and sale of TV products and trading of components.<sup>8</sup>

8. Defendant TCL MOKA International Limited (“TCL MOKA”) is a company duly organized and existing under the laws of Hong Kong SAR. It has a place of business at 13th Floor, TCL Tower, 8 Tai Chung Road, Tsuen Wan, New Territories, Hong Kong SAR, China. TCL MOKA may also be served with process by serving the Texas Secretary of State, 1019 Brazos Street, Austin, Texas 78701, as its agent for service because it engages in business in Texas but has not designated or maintained a resident agent for service of process in Texas as required by statute. This action arises out of that business.

9. TCL MOKA is a wholly owned subsidiary of TCL Technology. TCL MOKA is involved in the sale and importation of digital TVs.

10. Defendant TCL Smart Device (Vietnam) Co., Ltd. (“TCL Vietnam”) is a corporation duly organized and existing under the laws of Vietnam. It has a place of business at No. 26 VSIP II-A, Street 32, Vietnam Singapore Industrial Park II-A, Tan Binh Commune, Bac Tan Uyen District, Binh Duong Province, 75000, Vietnam. TCL Vietnam may also be served with process by serving the Texas Secretary of State, 1019 Brazos Street, Austin, Texas 78701, as its agent for service because it engages in business in Texas but has not designated or maintained a resident agent for service of process in Texas as required by statute. This action arises out of that business.

---

<sup>8</sup> See *supra* note **Error! Bookmark not defined.** at 140.

11. TCL Vietnam is a wholly owned subsidiary of TCL Industries Holdings Co., Ltd., which is part of the TCL group of companies and its ultimate holding company. TCL Vietnam is involved in the manufacture and sale of TV products.<sup>9</sup>

12. Defendant TCT Mobile International Limited (“TCT Mobile”) is a company duly organized and existing under the laws of Hong Kong SAR. It has a place of business at 5/F, Building 22E, 22 Science Park East Avenue, Hong Kong Science Park, Shatin, New Territories, Hong Kong SAR, China. TCT Mobile may also be served with process by serving the Texas Secretary of State, 1019 Brazos Street, Austin, Texas 78701, as its agent for service because it engages in business in Texas but has not designated or maintained a resident agent for service of process in Texas as required by statute. This action arises out of that business.

13. TCT Mobile is an indirect wholly owned subsidiary of TCL Electronics. TCT Mobile is involved in the development and distribution of mobile devices and other products, and rendering of services.<sup>10</sup>

14. Defendant Huizhou TCL Mobile Communication Co., Ltd. (“Huizhou TCL”) is a corporation duly organized and existing under the laws of the People’s Republic of China. It has a place of business at No. 86, West Hechang Road, Zhongkai High-Tech Zone, Huizhou, Guangdong Province, China. Huizhou TCL may also be served with process by serving the Texas Secretary of State, 1019 Brazos Street, Austin, Texas 78701, as its agent for service because it engages in business in Texas but has not designated or maintained a resident agent for service of process in Texas as required by statute. This action arises out of that business.

---

<sup>9</sup> See *supra* note 8 at 139.

<sup>10</sup> See *supra* note 9 at 141.

15. Huizhou TCL is an indirect wholly owned subsidiary of TCL Electronics. Huizhou TCL is involved in the manufacture and distribution of mobile devices, and rendering of services.<sup>11</sup>

16. The Defendants identified in paragraphs 2–15 above (collectively, “TCL”) are an interrelated group of companies which together comprise one of the world’s largest manufacturers of televisions and smartphones and one of the leading sellers of televisions and smartphones in the United States, including the TCL, Alcatel, and Samsung brands. TCL, which refers to the company and its subsidiaries as the “Group,” describes itself as “a world-leading consumer electronics company”<sup>12</sup> and states that the Group is “mainly involved in the manufacture and sale of television (“TV”) sets, smartphones, smart connective devices, smart commercial display and smart home products, photovoltaic equipment and the provision of internet platform operating services.”<sup>13</sup>

17. The TCL defendants named above and their affiliates are part of the same corporate structure and distribution chain for the making, importing, offering to sell, selling, and using of the accused devices in the United States, including in the State of Texas generally and this judicial district in particular.

18. The TCL defendants named above and their affiliates share the same management, common ownership, advertising platforms, facilities, distribution chains and platforms, and accused product lines and products involving related technologies.

---

<sup>11</sup> *Id.*

<sup>12</sup> *See supra* note 1, at 3.

<sup>13</sup> *See supra* note 12, at 138.

19. Thus, the TCL defendants named above and their affiliates operate as a unitary business venture and are jointly and severally liable for the acts of patent infringement alleged herein.

20. The parties to this action are properly joined under 35 U.S.C. § 299 because the right to relief asserted against Defendants jointly and severally arises out of the same series of transactions or occurrences relating to the making and using of the same products or processes. Additionally, questions of fact common to all defendants will arise in this action.

### **JURISDICTION AND VENUE**

21. This is an action for infringement of United States patents arising under 35 U.S.C. §§ 271, 281, and 284–85, among others. This Court has subject matter jurisdiction of the action under 28 U.S.C. § 1331 and § 1338(a).

22. This Court has personal jurisdiction over the TCL defendants pursuant to due process and/or the Texas Long Arm Statute because, *inter alia*, (i) TCL has done and continues to do business in Texas; (ii) TCL has committed and continues to commit acts of patent infringement in the State of Texas, including making, using, offering to sell, and/or selling accused products in Texas, and/or importing accused products into Texas, including by Internet sales and/or sales via retail and wholesale stores, inducing others to commit acts of patent infringement in Texas, and/or committing a least a portion of any other infringements alleged herein in Texas, and (iii) TCL regularly places its products or services within the stream of commerce—directly, through subsidiaries, or through third parties—with the expectation and knowledge that such products or services will be sold or used in Texas and elsewhere in the United States. In addition, or in the alternative, this Court has personal jurisdiction over TCL pursuant to Fed. R. Civ. P. 4(k)(2).

23. Venue is proper in this district as to the TCL defendants, each of which is organized under the laws of a foreign jurisdiction. 28 U.S.C. § 1391(c)(3) provides that “a defendant not resident in the United States may be sued in any judicial district, and the joinder of such a defendant shall be disregarded in determining where the action may be brought with respect to other defendants.” *See also In re HTC Corp.*, 889 F.3d 1349 (Fed. Cir. 2018).

### **BACKGROUND**

24. The patents-in-suit generally relate to improvements in wireless communication technology that allow users to communicate over a wireless network. In particular, the patents are directed to methods and systems for selecting antennas in multiple-input, multiple-output (MIMO) wireless networks.

25. The technology of the patents-in-suit was developed by engineers at the Mitsubishi Electric Research Laboratories (MERL), which is the North American arm of Mitsubishi Electric. MERL was founded in 1991 in Cambridge, Massachusetts, and has been known for its focus on innovation and long-range research.<sup>14</sup> From its beginning, MERL was focused on pioneering new technologies in various industries, including computer graphics, digital communication, medical imaging, transportation etc.<sup>15</sup> In the early 2000s, for example, “MERL focused on standardization and developments of new emerging technologies,” such as “antenna selection, channel equalization, efficient channel state estimation, and Orthogonal Frequency Division Multiplexing (OFDM).”<sup>16</sup>

---

<sup>14</sup> See <https://www.merl.com/company/history>.

<sup>15</sup> See <https://www.merl.com/public/MERL-30Years.pdf>.

<sup>16</sup> *Id.* at 22.



26. The inventions disclosed in the patents-in-suit have been cited during patent prosecution multiple times by electronics companies, including Apple, Broadcom, Cisco, Ericsson, Fujitsu, Hewlett Packard, Hitachi, Huawei, Intel, Kyocera, LG Electronics, Marvell, MediaTek, Motorola Mobility, Nokia, NTT Docomo, Panasonic, Philips, Qualcomm, Siemens, Samsung, Sharp, Sony, Toshiba, and ZTE.

## COUNT I

### DIRECT INFRINGEMENT OF U.S. PATENT NO. 8,284,686

27. On October 9, 2012, United States Patent No. 8,284,686 (“the ’686 Patent”) was duly and legally issued by the United States Patent and Trademark Office for an invention entitled “Antenna/Beam Selection Training in MIMO Wireless LANS with Different Sounding Frames.”

28. Freedom Patents is the owner of the ’686 Patent, with all substantive rights in and to that patent, including the sole and exclusive right to prosecute this action and enforce the ’686 Patent against infringers, and to collect damages for all relevant times.

29. TCL made, had made, used, imported, provided, supplied, distributed, sold, and/or offered for sale products and/or systems including, for example, its TCL 65S455 (with 2x2 MIMO) family of TVs, the Alcatel LINKZONE 4G LTE Cat4 Mobile Wi-Fi (with 2x2 MIMO),<sup>17</sup> and other products<sup>18</sup> that implement MIMO Wi-Fi capabilities (“accused products”):

---

<sup>17</sup> The Alcatel LINKZONE 4G LTE Cat4 Mobile Wi-Fi has the TCL model number MW41NF. *See, e.g.*, <https://deviceatlas.com/device-data/devices/alcatel/mw41nf/46919001>.

<sup>18</sup> *See, e.g.*, TCL Smart TV 3-Series (32S356, 32S327, 40S325, 43S325, 28S305, 32S305, 40S305, 43S305, 49S305, 32S301, 32S321), Smart TV 4-Series (43S45, 43S453, 50S453, 55S453, 65S453, 75S453, 43S451, 50S451, 55S451, 65S451, 75S451, 85S451, 43S455, 50S455, 55S455, 58S455, 65S455, 75S455, 85S455, 43S446, 50S446, 55S446, 65S446, 75S446, 85S446, 43S431, 50S431, 55S431, 65S431, 75S431, 85S431, 43S435, 50S435, 55S435, 65S435, 75S435, 85S435, 43S434, 50S434, 55S434, 65S434, 70S434, 75S434, 55S41, 65S41, 55S21, 43S405, 49S405, 55S405, 65S405, 55S401, 65S401, 43S403, 49S403, 55S403, 65S403, 50S45, 75S45,



MODEL 65S455

**TCL 65" CLASS 4-SERIES 4K UHD HDR LED  
SMART ROKU TV - 65S455**

★★★★ 4.5 (45) Write a review

Suggested Price

**\$429.99**

WHERE TO BUY

**Source:** [www.tcl.com/us/en/products/home-theater/4-series/65-class-4-series-4k-uhd-led-smart-roku-tv-65s455](http://www.tcl.com/us/en/products/home-theater/4-series/65-class-4-series-4k-uhd-led-smart-roku-tv-65s455)

Wireless Connection

802.11ac 2x2 Dual Band (support 2.4GHz & 5GHz)

**Source:** [www.tcl.com/us/en/products/home-theater/4-series/65-class-4-series-4k-uhd-led-smart-roku-tv-65s455](http://www.tcl.com/us/en/products/home-theater/4-series/65-class-4-series-4k-uhd-led-smart-roku-tv-65s455)

70S430, 75S433), Smart TV 5-Series (43S515, 49S515, 55S515, 65S515, 43S517, 49S517, 55S517, 65S517, 50T555, 55T555, 65T555, 75T555, 50S555, 55S555, 65S555, 75S555, 50S546, 55S546, 65S546, 75S546, 50S535, 55S535, 65S535, 75S535, 55T551, 65T551, 55S531, 65S531), Smart TV 6-Series (55R655, 65R655, 75R655, 85R655, 55R646, 65R646, 75R646, 55R635, 65R635, 75R635, 55R613, 55R615, 65R615, 75R615, 65R648, 75R648), TCL Smartphone 30 Series (T776O1-2AWFUS11, T776O1-2BWFUS11, T781S, T767W), Smartphone 20 Series (T810S-2BLCUS11, T810S-2ALCUS11, T768S, T768O, T773O-2AAZUS11, T773O-2BAZUS11), Smartphone A Series (5004S), Smartphone 10 Series (T799B-2ALCUS11, T799B-2BLCUS11, T790S, T770B-2ALCUS11), TCL Tablets (9198S, 9048S, 9049L, 9050S), TCL Stylus 5G (T779W), TCL LinkZone 5G (MW513UW), etc.

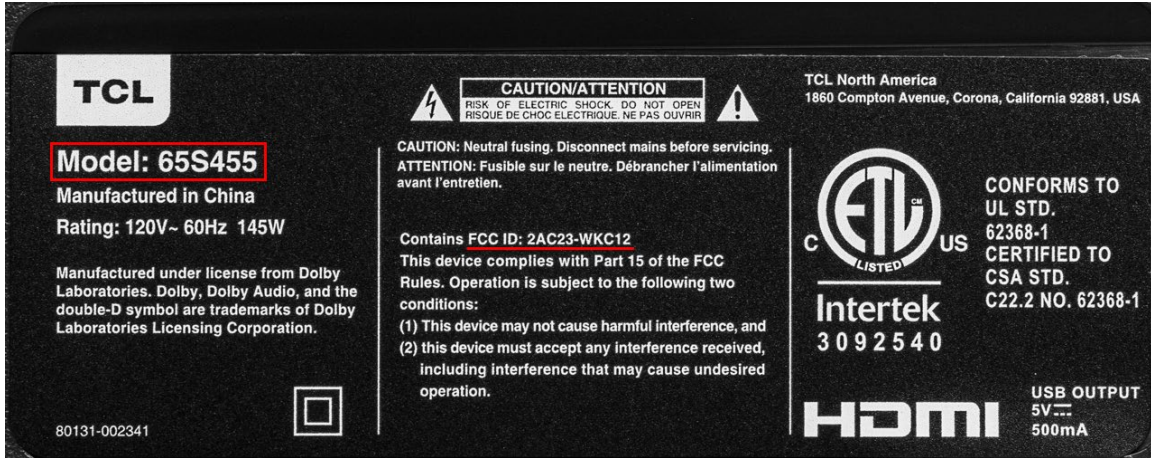

Source: [www.rtings.com/assets/products/gRVXk38E/tcl-4-series-s455-2022/label-large.jpg](http://www.rtings.com/assets/products/gRVXk38E/tcl-4-series-s455-2022/label-large.jpg)

## WIFI Module

### IEEE 802.11 a/b/g/n/ac 2T/2R

### Model Number: **WKC12R2501**

#### Product Description

The WKC12R2501 is a complete dual-band(2.4GHz and 5GHz)WIFI 2x2 MIMO module. This module provides a high level of integration with a dual-stream IEEE 802.11ac MAC/ base band /radio.The WLAN operation supports 20MHz,40MHz and 80MHz channels for data rates up to 866.7Mbps. It fully complies with IEEE 802.11 a/b/g/n/ac feature rich wireless connectivity at high standards,delivers reliable,cost-effective, throughput from an extended distance.

Source: <https://fccid.io/2AC23-WKC12/Users-Manual/User-manual-5654192>



Source: [www.alcatelmobile.com/product/mobile-broadband/mobile-wifi/linkzone-cat4-mobile-wi-fi](http://www.alcatelmobile.com/product/mobile-broadband/mobile-wifi/linkzone-cat4-mobile-wi-fi)

ANTENNA

LTE: 2X2 MIMO  
WCDMA: Internal  
GSM: Internal  
Wi-Fi: Internal 2X2

**Source:** [www.alcatelmobile.com/product/mobile-broadband/mobile-wifi/linkzone-cat4-mobile-wi-fi](http://www.alcatelmobile.com/product/mobile-broadband/mobile-wifi/linkzone-cat4-mobile-wi-fi)

30. By doing so, TCL has directly infringed (literally and/or under the doctrine of equivalents) at least Claims 1 and 21 of the '686 Patent. TCL's infringement in this regard is ongoing.

31. The TCL 65S455 Smart TV and the Alcatel LINKZONE 4G LTE Cat4 Mobile Wi-Fi are exemplary accused products.

32. TCL has infringed the '686 Patent by using the accused products and thereby practicing a method for selecting antennas in a multiple-input, multiple-output (MIMO) wireless local area network (WLAN) including a plurality of stations, each station including a set of antennas.

33. For example, the TCL 65S455 Smart TV and the Alcatel LINKZONE 4G LTE Cat4 Mobile Wi-Fi communicate with other stations using the IEEE 802.11 protocol and include a set of antennas that are used for both transmitting and receiving data to and from the other stations over a WLAN. The transmission and reception of data using multiple antennas simultaneously is known as MIMO ("multiple-input, multiple-output"). The stations communicating using MIMO implement the antenna selection process before establishing communication with each other.

# Part 11: Wireless LAN Medium Access Control (MAC) and Physical Layer (PHY) Specifications

## 1. Overview

### 1.1 Scope

The scope of this standard is to define one medium access control (MAC) and several physical layer (PHY) specifications for wireless connectivity for fixed, portable, and moving stations (STAs) within a local area.

Source: [IEEE 802.11-2016 Standard](#) (Page 122)

An HT STA has PHY features consisting of the modulation and coding scheme (MCS) set described in 19.3.5 and physical layer (PHY) protocol data unit (PPDU) formats described in 19.1.4. Some PHY features that distinguish an HT STA from a non-HT STA are referred to as *multiple input, multiple output (MIMO) operation*; spatial multiplexing (SM); spatial mapping (including transmit beamforming); space-time block coding (STBC); low-density parity check (LDPC) encoding; and antenna selection (ASEL). The allowed PPDU formats are non-HT format, HT-mixed format, and HT-greenfield format (see 19.1.4). The PPDUs can be transmitted with 20 MHz bandwidth and might be transmitted with 40 MHz bandwidth.

Source: [IEEE 802.11-2016 Standard](#) (Page 197)

**multiple input, multiple output (MIMO):** A physical layer (PHY) configuration in which both transmitter and receiver use multiple antennas.

Source: [IEEE 802.11-2016 Standard](#) (Page 136)

**multi-user multiple input, multiple output (MU-MIMO):** A technique by which multiple stations (STAs), each with one or more antennas, either simultaneously transmit to a single STA or simultaneously receive from a single STA independent data streams over the same radio frequencies.

NOTE—IEEE Std 802.11 supports only downlink (DL) MU-MIMO. See **downlink multi-user multiple input, multiple output (DL-MU-MIMO)** (in 3.2).

Source: [IEEE 802.11-2016 Standard](#) (Page 136)

## 10.31 Link adaptation

### 10.31.1 Introduction

To fully exploit MIMO channel variations and transmit beamforming on a MIMO link, a STA can request that another STA provide MIMO channel sounding and MFB.

Source: [IEEE 802.11-2016 Standard](#) (Page 1463)

**10.30 Sounding PPDUs**

The behavior described in this subclause is specific to the use of the HT variant HT Control field.

A sounding PPDU is a PPDU for which the SOUNDING parameter of the corresponding RXVECTOR or TXVECTOR has the value SOUNDING. Sounding PPDUs are transmitted by STAs to enable the receiving STAs to estimate the channel between the transmitting STA and the receiving STA.

A STA transmits sounding PPDUs when it operates in the following roles:

- MFB requester (see 10.31.2)
- HT beamformee responding to a training request, calibration initiator, or responder involved in implicit transmit beamforming (see 10.32.2.2, 10.32.2.3, and 10.32.2.4)
- HT beamformer involved in explicit transmit beamforming (see 10.32.3)
- ASEL transmitter and ASEL sounding-capable transmitter involved in ASEL (see 10.33.2)

A STA receives sounding PPDUs when it operates in the following roles:

- MFB responder (see 10.31.2)
- HT beamformer sending a training request, calibration initiator, or responder involved in implicit transmit beamforming (see 10.32.2.2, 10.32.2.3, and 10.32.2.4)
- HT beamformee involved in explicit transmit beamforming (see 10.32.3)
- Transmit ASEL responder and ASEL receiver involved in ASEL (see 10.33.2)

Source: [IEEE 802.11-2016 Standard](#) (Pages 1462-63)

**10.33 Antenna selection (ASEL)****10.33.1 Introduction**

The procedures in this subclause apply only to HT and non-HT PPDUs for which the HT Control field, if present, is the HT variant HT Control field.

ASEL is a time-variant mapping of the signals at the RF chains onto a set of antenna elements when the number of RF chains is smaller than the number of antenna elements. The mapping might be chosen based on instantaneous or averaged CSI. ASEL requires the training of the full size channel associated with all antenna elements, which is obtained by transmitting or receiving sounding PPDUs over all antennas. These sounding PPDUs should be sent within a single TXOP. To avoid channel distortions, these sounding PPDUs shall be transmitted consecutively. The training information is exchanged using the HT Control field. When both transmitter and receiver have ASEL capabilities, training of transmit and receive antennas might be done one after another. ASEL supports up to eight antennas and up to four RF chains.

Source: [IEEE 802.11-2016 Standard](#) (Page 1481)

34. The method practiced using the accused products includes the step of receiving, via a channel, at a station in the WLAN plural consecutive packets including plural sounding packets, each sounding packet corresponding to a different subset of the set of antennas, and at

least one of the plural consecutive packets including (i) a high throughput (HT) control field including a signal to initiate antenna selection and (ii) a number N indicative of a number of sounding packets which follow the at least one packet including the HT control field and which are to be used for antenna selection.

35. For example, during the antenna selection process, the stations receive multiple consecutive sounding PPDU ("plural sounding packets"). Each sounding PPDU corresponds to a different set of antennas from the available antennas. The first PPDU frame received is a +HTC frame followed by consecutive NDP (Null Data Packet) frames.

### 10.30 Sounding PPDU

The behavior described in this subclause is specific to the use of the HT variant HT Control field.

A sounding PPDU is a PPDU for which the SOUNDING parameter of the corresponding RXVECTOR or TXVECTOR has the value SOUNDING. Sounding PPDU are transmitted by STAs to enable the receiving STAs to estimate the channel between the transmitting STA and the receiving STA.

A STA transmits sounding PPDU when it operates in the following roles:

- MFB requester (see 10.31.2)
- HT beamformee responding to a training request, calibration initiator, or responder involved in implicit transmit beamforming (see 10.32.2.2, 10.32.2.3, and 10.32.2.4)
- HT beamformer involved in explicit transmit beamforming (see 10.32.3)
- ASEL transmitter and ASEL sounding-capable transmitter involved in ASEL (see 10.33.2)

A STA receives sounding PPDU when it operates in the following roles:

- MFB responder (see 10.31.2)
- HT beamformer sending a training request, calibration initiator, or responder involved in implicit transmit beamforming (see 10.32.2.2, 10.32.2.3, and 10.32.2.4)
- HT beamformee involved in explicit transmit beamforming (see 10.32.3)
- Transmit ASEL responder and ASEL receiver involved in ASEL (see 10.33.2)

Source: [IEEE 802.11-2016 Standard](#) (Pages 1462-63)

### 10.33 Antenna selection (ASEL)

#### 10.33.1 Introduction

The procedures in this subclause apply only to HT and non-HT PPDU for which the HT Control field, if present, is the HT variant HT Control field.

ASEL is a time-variant mapping of the signals at the RF chains onto a set of antenna elements when the number of RF chains is smaller than the number of antenna elements. The mapping might be chosen based on instantaneous or averaged CSI. ASEL requires the training of the full size channel associated with all antenna elements, which is obtained by transmitting or receiving sounding PPDU over all antennas. These sounding PPDU should be sent within a single TXOP. To avoid channel distortions, these sounding PPDU shall be transmitted consecutively. The training information is exchanged using the HT Control field. When both transmitter and receiver have ASEL capabilities, training of transmit and receive antennas might be done one after another. ASEL supports up to eight antennas and up to four RF chains.

Source: [IEEE 802.11-2016 Standard](#) (Page 1481)

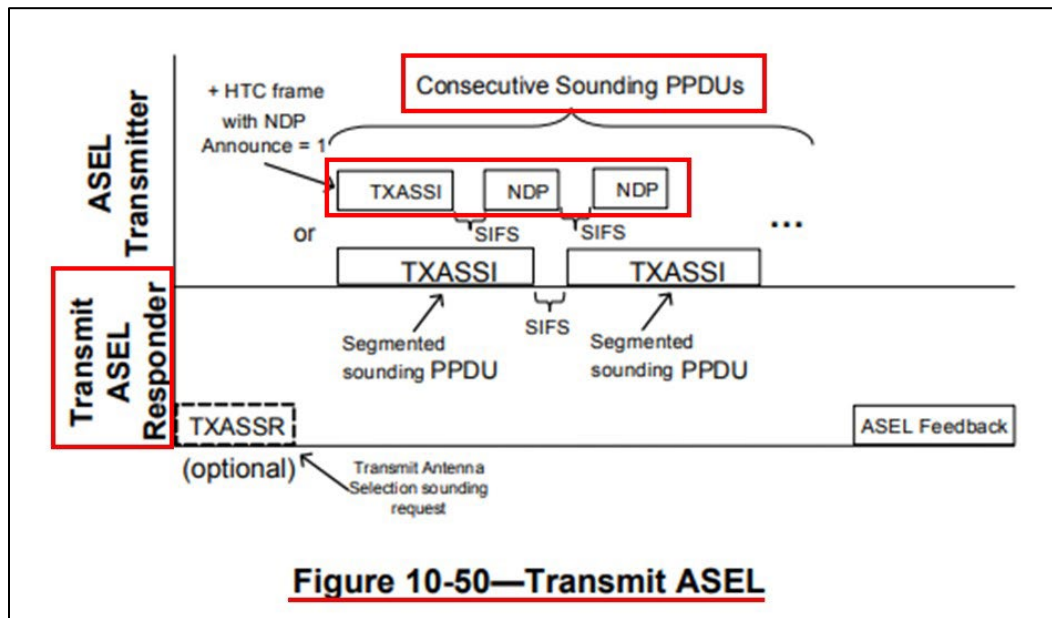

Source: [IEEE 802.11-2016 Standard](#) (Page 1483)

36. The sounding PPDU's are Media Access Control (MAC) frames that comprise a set of fields, which can include a High Throughput (HT) control field. A frame that contains the HT Control field is referred to as "+HTC Frame." The HT Control field of a MAC frame can be of two types: High Throughput (HT) or Very High Throughput (VHT). The antenna selection procedure applies to HT PPDU's (e.g., PPDU's that have an HT variant HT control field).



**9.2.3 General frame format**

The MAC frame format comprises a set of fields that occur in a fixed order in all frames. Figure 9-1 depicts the general MAC frame format. The first three fields (Frame Control, Duration/ID, and Address 1) and the last field (FCS) in Figure 9-1 constitute the minimal frame format and are present in all frames, including reserved types and subtypes. The fields Address 2, Address 3, Sequence Control, Address 4, QoS Control, HT Control, and Frame Body are present only in certain frame types and subtypes. Each field is defined in 9.2.4. The format of each of the individual subtypes of each frame type is defined in 9.3. The components of management frame bodies are defined in 9.4. The formats of Action frames are defined in 9.6.

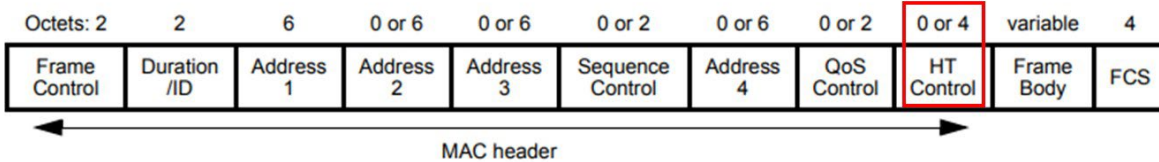

**Figure 9-1—MAC frame format**

Source: [IEEE 802.11-2016 Standard](#) (Pages 637-38)

A frame that contains the HT Control field is referred to as a +HTC frame. A Control Wrapper frame is a +HTC frame.

Source: [IEEE 802.11-2016 Standard](#) (Page 637)

### 9.2.4.6 HT Control field

#### 9.2.4.6.1 General

The HT Control field is always present in a Control Wrapper frame and is present in QoS Data and Management frames as determined by the +HTC/Order subfield of the Frame Control field as defined in 9.2.4.1.10.

NOTE—The only control frame subtype for which HT Control field is present is the Control Wrapper frame. A Control frame that is described as +HTC (e.g., an RTS+HTC, CTS+HTC, BlockAck+HTC or BlockAckReq+HTC frame) implies the use of the Control Wrapper frame to carry that Control frame.

The format of the 4-octet HT Control field is shown in Figure 9-8.

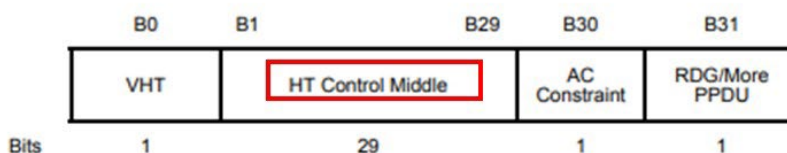

**Figure 9-8—HT Control field**

The HT Control field has two forms, the HT variant and the VHT variant. The two forms differ in the format of the HT Control Middle subfield, described in 9.2.4.6.2 for the HT variant and in 9.2.4.6.3 for the VHT variant and in the value of the VHT subfield.

The VHT subfield of the HT Control field indicates whether the HT Control Middle subfield is the VHT Variant or the HT Variant. The VHT subfield is set to 1 to indicate that the HT Control Middle subfield is the VHT Variant and is set to 0 to indicate that the HT Control Middle subfield is the HT Variant.

Source: [IEEE 802.11-2016 Standard](#) (Page 654)

### 10.33 Antenna selection (ASEL)

#### 10.33.1 Introduction

The procedures in this subclause apply only to HT and non-HT PPDU for which the HT Control field, if present, is the HT variant HT Control field.

ASEL is a time-variant mapping of the signals at the RF chains onto a set of antenna elements when the number of RF chains is smaller than the number of antenna elements. The mapping might be chosen based on instantaneous or averaged CSI. ASEL requires the training of the full size channel associated with all antenna elements, which is obtained by transmitting or receiving sounding PPDU over all antennas. These sounding PPDU should be sent within a single TXOP. To avoid channel distortions, these sounding PPDU shall be transmitted consecutively. The training information is exchanged using the HT Control field. When both transmitter and receiver have ASEL capabilities, training of transmit and receive antennas might be done one after another. ASEL supports up to eight antennas and up to four RF chains.

Source: [IEEE 802.11-2016 Standard](#) (Page 1481)

37. The +HTC frames (“at least one of the plural consecutive packets”) contain the HT variant HT Control field. The HT Control field also contains an HT control middle subfield,

which further contains an LAC subfield. The LAC subfield allows the station to perform antenna selection. The LAC frame format includes the MAI subfield (MCS request or ASEL Indication) and the MFB/ASELC subfield (MCS Feedback/Antenna Selection Command). If the MAI subfield is set to “14,” the MFB/ASELC subfield acts as the Antenna Selection Command. The frame format of the ASELC subfield contains ASEL Command and ASEL Data subfields.

38. As one example, if the ASEL Command of the LAC frame is set to “0,” it is interpreted as TXASSI (“Transmit Antenna Selection Sounding Indication”), a signal to initiate antenna selection. And the ASEL Data field contains the remaining number of sounding PPDUs to be transmitted (“a number N indicative of a number of sounding packets”).

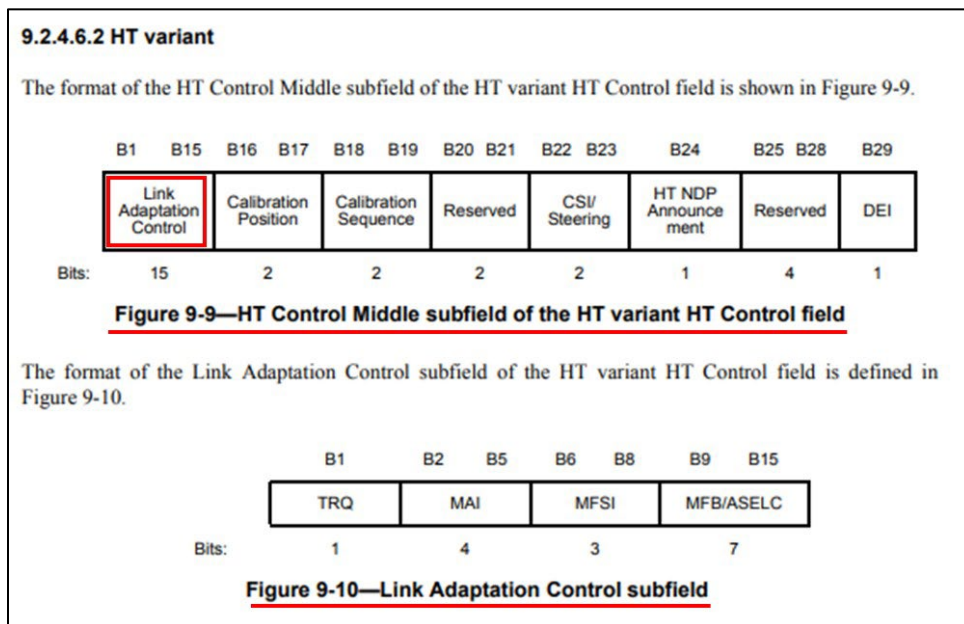

Source: [IEEE 802.11-2016 Standard](#) (Page 655)

**Table 9-12—Subfields of Link Adaptation Control subfield**

Subfield	Meaning	Definition
TRQ	Training request	Set to 1 to request the responder to transmit a sounding PPDU. Set to 0 to indicate that the responder is not requested to transmit a sounding PPDU. See 10.32.2 and 10.34.2.
MAI	MCS request (MRQ) or ASEL indication	Set to 14 (indicating ASEL) to indicate that the MFB/ASEL subfield is interpreted as ASEL. Otherwise, the MAI subfield is interpreted as shown in Figure 9-11, and the MFB/ASEL subfield is interpreted as MCS feedback (MFB).
MFSI	MCS feedback sequence identifier	Set to the received value of MSI contained in the frame to which the MFB information refers. Set to 7 for unsolicited MFB.
MFB/ASEL	MCS feedback and antenna selection command/data	When the MAI subfield is equal to the value ASEL, this subfield is interpreted as defined in Figure 9-12 and Table 9-14. Otherwise, this subfield contains recommended MFB. A value of 127 indicates that no feedback is present.

The structure of the MAI subfield of the Link Adaptation Control subfield is defined in Figure 9-11. The subfields of the MAI subfield are defined in Table 9-13.

B0                  B1                                  B3  
 ┌───┬──────────┐  
 │ MRQ │          │ MSI  
 └───┴──────────┘  
 Bits:        1                                  3

**Figure 9-11—MAI subfield**

Source: [IEEE 802.11-2016 Standard](#) (Page 656)

The ASEL subfield of the Link Adaptation Control subfield contains the ASEL Command and ASEL Data subfields, as shown in Figure 9-12. The encoding of these subfields is shown in Table 9-14.

B0                          B2    B3                  B6  
 ┌──────────┬──────────┐  
 │ ASEL Command │ ASEL Data │  
 └──────────┴──────────┘  
 Bits:                          3                          4

**Figure 9-12—ASELC subfield**

Source: [IEEE 802.11-2016 Standard](#) (Page 657)

**Table 9-14—ASEL Command and ASEL Data subfields**

ASEL Command	Interpretation of ASEL Command	ASEL Data
0	Transmit Antenna Selection Sounding Indication (TXASSI)	Number of remaining sounding PPDU's to be transmitted 0 to 15
		See NOTE
1	Transmit Antenna Selection Sounding Request (TXASSR) or Transmit ASEL Sounding Resumption	0 when the command is Transmit ASEL Sounding Request A number in the range 1 to 15, the number being the number of the first sounding PPDU to be transmitted when the command is Transmit ASEL Sounding Resumption, where 0 corresponds to the first sounding PPDU in the original ASEL training sequence
2	Receive Antenna Selection Sounding Indication (RXASSI)	Number of remaining sounding PPDU's to be received 0 to 15
		See NOTE
3	Receive Antenna Selection Sounding Request (RXASSR)	Number of sounding PPDU's required 0 to 15
4	Sounding Label	Sequence number of the sounding PPDU corresponding to a channel state information (CSI) frame in ASEL feedback 0 to 15
5	No Feedback Due to ASEL Training Failure or Stale Feedback	A number in the range 0 to 15, the number being the number of the first sounding PPDU that was not received properly, where 0 corresponds to the first sounding PPDU in the ASEL training sequence, or 0 if no sounding PPDU's were received properly, or 0 if this is a request for a full retraining sequence
6	Transmit Antenna Selection Sounding Indication requesting feedback of explicit CSI (TXASSI-CSI)	Number of remaining sounding PPDU's to be transmitted 0 to 15
		See NOTE
7	Reserved	Reserved
<p><b>NOTE—</b><u>If the HT variant HT Control field is carried in a sounding PPDU, then the value of the ASEL Data field contains the remaining number of sounding frames following the current one. If null data packet (NDP) sounding frame is used, then the value in the ASEL Data field contains the number of NDP's following a non-NDP+HTC. The HT NDP Announcement subfield in the HT Control field is set to 1 to indicate NDP sounding.</u></p>		

Source: [IEEE 802.11-2016 Standard](#) (Page 657)

39. The method practiced using the accused products includes the step of estimating a channel matrix based on a characteristic of the channel as indicated by the received N sounding packets.

40. For example, the transmit ASEL responder station receives the sounding PPDU's ("N sounding packets"). The transmit ASEL responder station then estimates the channel state information ("a characteristic of the channel") based on the measurements from the received sounding PPDU's, each of which corresponds to a different set of antennas. After the estimate is complete, a Channel State Information report (CSI report) is generated and sent to the ASEL transmitter station. The CSI report is embedded in a CSI frame. The CSI Report field contains a

Channel Matrix subfield, which contains the channel matrices estimated for the different channels.

### 19.3.13.3 Sounding PPDU for calibration

In the case of a bidirectional calibration exchange, two STAs exchange sounding PPDU, the exchange of which enables the receiving STA to compute an estimate of the MIMO channel matrix  $H_k$  for each subcarrier  $k$ . In general, in an exchange of calibration messages, the number of spatial streams is less than the number of transmit antennas. In such cases, HT-ELTFs are used. In the case of sounding PPDU for calibration, the antenna mapping matrix shall be as shown in Equation (19-86).

$$Q_k = C_{CSD}(k)P_{CAL} \quad (19-86)$$

Source: [IEEE 802.11-2016 Standard](#) (Page 2401)

### 10.30 Sounding PPDU

The behavior described in this subclause is specific to the use of the HT variant HT Control field.

A sounding PPDU is a PPDU for which the SOUNDING parameter of the corresponding RXVECTOR or TXVECTOR has the value SOUNDING. Sounding PPDU are transmitted by STAs to enable the receiving STAs to estimate the channel between the transmitting STA and the receiving STA.

A STA transmits sounding PPDU when it operates in the following roles:

- MFB requester (see 10.31.2)
- HT beamformee responding to a training request, calibration initiator, or responder involved in implicit transmit beamforming (see 10.32.2.2, 10.32.2.3, and 10.32.2.4)
- HT beamformer involved in explicit transmit beamforming (see 10.32.3)
- ASEL transmitter and ASEL sounding-capable transmitter involved in ASEL (see 10.33.2)

A STA receives sounding PPDU when it operates in the following roles:

- MFB responder (see 10.31.2)
- HT beamformer sending a training request, calibration initiator, or responder involved in implicit transmit beamforming (see 10.32.2.2, 10.32.2.3, and 10.32.2.4)
- HT beamformee involved in explicit transmit beamforming (see 10.32.3)
- Transmit ASEL responder and ASEL receiver involved in ASEL (see 10.33.2)

Source: [IEEE 802.11-2016 Standard](#) (Pages 1462-63)

The frame exchange sequence for transmit ASEL is shown in Figure 10-50, where the term *ASEL transmitter* identifies the STA that is conducting transmit ASEL, and the term *transmit ASEL responder* identifies the STA that provides ASEL feedback. The frame exchange comprises the following steps:

- a) (Optional) A transmit ASEL responder may initiate the transmit ASEL training by sending a +HTC frame with the ASEL Command subfield set to Transmit Antenna Selection Sounding Request (TXASSR).
- b) The ASEL transmitter sends out consecutive sounding PPDU's separated by SIFS in a TXOP of which it is the TXOP holder with no acknowledgment over different antenna sets, each PPDU containing a +HTC frame with the ASEL Command subfield set to Transmit Antenna Selection Sounding Indication (TXASSI or TXASSI-CSI). Each sounding PPDU is transmitted over one antenna set.

Source: [IEEE 802.11-2016 Standard](#) (Page 1482)

- c) The transmit ASEL responder estimates the subchannel corresponding to each sounding PPDU.
- d) If the ASEL Command subfield in the sounding frames is equal to TXASSI-CSI, after receiving all of the sounding PPDU's, the transmit ASEL responder shall respond with the full size CSI in a subsequent TXOP. If the ASEL Command subfield in the sounding frames is equal to TXASSI, after receiving all of the sounding PPDU's, the transmit ASEL responder may either respond with the full size CSI in a subsequent TXOP, or conduct ASEL computation and provide the selected antenna indices in a subsequent TXOP.
  - 1) CSI is transported using the MIMO CSI Matrices frame defined in 9.6.12.6 contained within either an Action No Ack or Action frame. Multiple CSI frames may be required to provide the complete feedback, in which case the value of the Sounding Timestamp field within each of

Source: [IEEE 802.11-2016 Standard](#) (Page 1482)

When the MIMO channel measurements become available at STA B, STA B shall send one or more CSI frames that contain the CSI report (Step 2 in Figure 10-47). This CSI report shall have full precision, i.e.,  $N_g=1$  (no grouping) and  $N_b=3$  (8 bits). In these CSI frames, the Calibration Sequence subfields in HT Control fields shall be set to the same value that is indicated in the Calibration Sounding Complete frame. These CSI frames shall have a frame type of Management Action +HTC.

Source: [IEEE 802.11-2016 Standard](#) (Page 1477)

**9.6.12.6 CSI frame format**

The CSI frame is an Action or an Action No Ack frame of category HT. The format of its Action field is defined in Table 9-338.

**Table 9-338—CSI frame Action field format**

Order	Information
1	Category
2	HT Action
3	MIMO Control (see 9.4.1.27)
4	<u>CSI Report</u> (see 9.4.1.28)

Source: [IEEE 802.11-2016 Standard](#) (Page 1214)

**9.4.1.28 CSI Report field**

The CSI Report field is used by the CSI frame (see 9.6.12.6) to carry explicit channel state information to a transmit HT beamformer, as described in 10.32.3.

The CSI Matrix subfields in the CSI Report field shown in Table 9-52 and Table 9-53 are matrices whose elements are taken from the CHAN\_MAT parameter of RXVECTOR (see Table 19-1).

**Table 9-52—CSI Report field (20 MHz)**

Field	Size (bits)	Meaning
SNR in receive chain 1	8	Signal-to-noise ratio in the first receive chain of the STA sending the report.
...		
SNR in receive chain $N_r$	8	Signal-to-noise ratio in the $N_r$ 'th receive chain of the STA sending the report.
<u>CSI Matrix for carrier -28</u>	$3+2 \times N_b \times N_c \times N_r$	<u>CSI matrix (see Figure 9-95)</u>
...		

Source: [IEEE 802.11-2016 Standard](#) (Page 746)



Parameter	Condition	Value	TXVECTOR	RXVECTOR
			See NOTE 1	
CHAN_MAT	CHAN_MAT_TYPE is COMPRESSED_SV	Contains a set of compressed beamforming feedback matrices as defined in 19.3.12.3.6 based on the channel measured during the training symbols of the received PPDU. The number of elements depends on the number of spatial streams and the number of transmit chains.	N	Y
	CHAN_MAT_TYPE is NON_COMPRESSED_SV	Contains a set of noncompressed beamforming feedback matrices as defined in 19.3.12.3.5 based on the channel measured during the training symbols of the received PPDU. The number of complex elements is $N_{ST} \times N_r \times N_c$ where $N_{ST}$ is the total number of subcarriers, $N_c$ is the number of columns, and $N_r$ is the number of rows in each matrix.	N	Y
	CHAN_MAT_TYPE is CSI_MATRICES	Contains a set of CSI matrices as defined in 19.3.12.3.2 based on the channel measured during the training symbols of the received PPDU. The number of complex elements is $N_{ST} \times N_r \times N_c$ where $N_{ST}$ is the total number of subcarriers, $N_c$ is the number of columns, and $N_r$ is the number of rows in each matrix.	N	Y
	Otherwise	Not present	N	N
CHAN_MAT_TYPE	FORMAT is HT_MF or HT_GF	Enumerated type: COMPRESSED_SV indicates that CHAN_MAT is a set of compressed beamforming vector matrices. NON_COMPRESSED_SV indicates that CHAN_MAT is a set of noncompressed beamforming vector matrices. <u>CSI_MATRICES indicates that CHAN_MAT is a set of channel state matrices.</u>	N	Y
	Otherwise	Not present	N	N

Source: [IEEE 802.11-2016 Standard](#) (Pages 2340-41)

41. The method practiced using the accused products includes the step of selecting a subset of antennas according to the channel matrix, wherein the receiving further comprises receiving a non-ZLF+HTC packet immediately followed by plural consecutive zero length frame (ZLF) sounding packets, the non-ZLF+HTC packet having an antenna selection control (ASC) field including a transmit antenna selection sounding indication (TXASSI) signal to initiate antenna selection and a number N of the plural consecutive ZLF sounding packets.

42. For example, the transmit ASEL responder station, after receiving the consecutive sounding packets, estimates the Channel State Information (CSI) and generates a Channel State Information report (CSI report), which includes channel matrices. Based on the channel

matrices, the set of antennas to be used for MIMO communication is selected (“selecting a subset of antennas”).

43. During the antenna selection process, the ASEL transmitter station transmits consecutive sounding PPDU's in which at least one of the PPDU's contains a +HTC frame (“non-ZLF+HTC packet”) with the ASEL Command subfield set to TXASSI (“Transmit Antenna Selection Sounding Indication”). After receiving all the sounding PPDU's, e.g., sounding NDPs (“plural consecutive zero length frame (ZLF) sounding packets”), channel state information for all channels is measured, and the channel matrix is estimated. Based on the estimated channel matrix, the transmit ASEL performs antenna selection and subsequently provides the selected antenna indices.

**Antenna Selection.** There are  $M$  columns and  $N$  rows in the CSI matrix  $\mathbf{H}$ ; each corresponds to one transmit or receive antenna. To compute the Effective CSI that would be used under a particular antenna selection, we simply pick the subset of rows and columns that correspond to the desired antennas. Note that this includes both transmit antenna selection (e.g., when  $S < M$ , pick the best  $S$  of the  $M$  transmit antennas to send with) and receive antenna selection (e.g., when  $N > S$ , turn off the least useful of the excess antennas in order to reduce power consumption).

**Source:** <https://arxiv.org/ftp/arxiv/papers/1301/1301.6644.pdf> (Page 76)

### 10.33 Antenna selection (ASEL)

#### 10.33.1 Introduction

The procedures in this subclause apply only to HT and non-HT PPDU's for which the HT Control field, if present, is the HT variant HT Control field.

ASEL is a time-variant mapping of the signals at the RF chains onto a set of antenna elements when the number of RF chains is smaller than the number of antenna elements. The mapping might be chosen based on instantaneous or averaged CSI. ASEL requires the training of the full size channel associated with all antenna elements, which is obtained by transmitting or receiving sounding PPDU's over all antennas. These sounding PPDU's should be sent within a single TXOP. To avoid channel distortions, these sounding PPDU's shall be transmitted consecutively. The training information is exchanged using the HT Control field. When both transmitter and receiver have ASEL capabilities, training of transmit and receive antennas might be done one after another. ASEL supports up to eight antennas and up to four RF chains.

Source: [IEEE 802.11-2016 Standard](#) (Page 1481)

The frame exchange sequence for transmit ASEL is shown in Figure 10-50, where the term *ASEL transmitter* identifies the STA that is conducting transmit ASEL, and the term *transmit ASEL responder* identifies the STA that provides ASEL feedback. The frame exchange comprises the following steps:

- a) (Optional) A transmit ASEL responder may initiate the transmit ASEL training by sending a +HTC frame with the ASEL Command subfield set to Transmit Antenna Selection Sounding Request (TXASSR).
- b) The ASEL transmitter sends out consecutive sounding PPDU's separated by SIFS in a TXOP of which it is the TXOP holder with no acknowledgment over different antenna sets, each PPDU containing a +HTC frame with the ASEL Command subfield set to Transmit Antenna Selection Sounding Indication (TXASSI or TXASSI-CSI). Each sounding PPDU is transmitted over one antenna set.

Source: [IEEE 802.11-2016 Standard](#) (Page 1482)

- c) The transmit ASEL responder estimates the subchannel corresponding to each sounding PPDU.
- d) If the ASEL Command subfield in the sounding frames is equal to TXASSI-CSI, after receiving all of the sounding PPDU's, the transmit ASEL responder shall respond with the full size CSI in a subsequent TXOP. If the ASEL Command subfield in the sounding frames is equal to TXASSI, after receiving all of the sounding PPDU's, the transmit ASEL responder may either respond with the full size CSI in a subsequent TXOP, or conduct ASEL computation and provide the selected antenna indices in a subsequent TXOP.
  - 1) CSI is transported using the MIMO CSI Matrices frame defined in 9.6.12.6 contained within either an Action No Ack or Action frame. Multiple CSI frames may be required to provide the complete feedback, in which case the value of the Sounding Timestamp field within each of

Source: [IEEE 802.11-2016 Standard](#) (Page 1482)

When the MIMO channel measurements become available at STA B, STA B shall send one or more CSI frames that contain the CSI report (Step 2 in Figure 10-47). This CSI report shall have full precision, i.e.  $N_g=1$  (no grouping) and  $N_b=3$  (8 bits). In these CSI frames, the Calibration Sequence subfields in HT Control fields shall be set to the same value that is indicated in the Calibration Sounding Complete frame. These CSI frames shall have a frame type of Management Action +HTC.

Source: [IEEE 802.11-2016 Standard](#) (Page 1477)

**9.6.12.6 CSI frame format**

The CSI frame is an Action or an Action No Ack frame of category HT. The format of its Action field is defined in Table 9-338.

**Table 9-338—CSI frame Action field format**

Order	Information
1	Category
2	HT Action
3	MIMO Control (see 9.4.1.27)
4	<u>CSI Report</u> (see 9.4.1.28)

Source: [IEEE 802.11-2016 Standard](#) (Page 1214)

**9.4.1.28 CSI Report field**

The CSI Report field is used by the CSI frame (see 9.6.12.6) to carry explicit channel state information to a transmit HT beamformer, as described in 10.32.3.

The CSI Matrix subfields in the CSI Report field shown in Table 9-52 and Table 9-53 are matrices whose elements are taken from the CHAN\_MAT parameter of RXVECTOR (see Table 19-1).

**Table 9-52—CSI Report field (20 MHz)**

Field	Size (bits)	Meaning
SNR in receive chain 1	8	Signal-to-noise ratio in the first receive chain of the STA sending the report.
...		
SNR in receive chain $N_r$	8	Signal-to-noise ratio in the $N_r$ 'th receive chain of the STA sending the report.
<u>CSI Matrix for carrier -28</u>	$3+2 \times N_b \times N_c \times N_r$	<u>CSI matrix (see Figure 9-95)</u>
...		

Source: [IEEE 802.11-2016 Standard](#) (Page 746)

Parameter	Condition	Value	TXVECTOR	RXVECTOR
			See NOTE 1	
CHAN_MAT	CHAN_MAT_TYPE is COMPRESSED_SV	Contains a set of compressed beamforming feedback matrices as defined in 19.3.12.3.6 based on the channel measured during the training symbols of the received PPDU. The number of elements depends on the number of spatial streams and the number of transmit chains.	N	Y
	CHAN_MAT_TYPE is NON_COMPRESSED_SV	Contains a set of noncompressed beamforming feedback matrices as defined in 19.3.12.3.5 based on the channel measured during the training symbols of the received PPDU. The number of complex elements is $N_{ST} \times N_r \times N_c$ where $N_{ST}$ is the total number of subcarriers, $N_c$ is the number of columns, and $N_r$ is the number of rows in each matrix.	N	Y
	CHAN_MAT_TYPE is CSI_MATRICES	Contains a set of CSI matrices as defined in 19.3.12.3.2 based on the channel measured during the training symbols of the received PPDU. The number of complex elements is $N_{ST} \times N_r \times N_c$ where $N_{ST}$ is the total number of subcarriers, $N_c$ is the number of columns, and $N_r$ is the number of rows in each matrix.	N	Y
	Otherwise	Not present	N	N
CHAN_MAT_TYPE	FORMAT is HT_MF or HT_GF	Enumerated type: COMPRESSED_SV indicates that CHAN_MAT is a set of compressed beamforming vector matrices. NON_COMPRESSED_SV indicates that CHAN_MAT is a set of noncompressed beamforming vector matrices. <u>CSI_MATRICES indicates that CHAN_MAT is a set of channel state matrices.</u>	N	Y
	Otherwise	Not present	N	N

Source: [IEEE 802.11-2016 Standard](#) (Pages 2340-41)

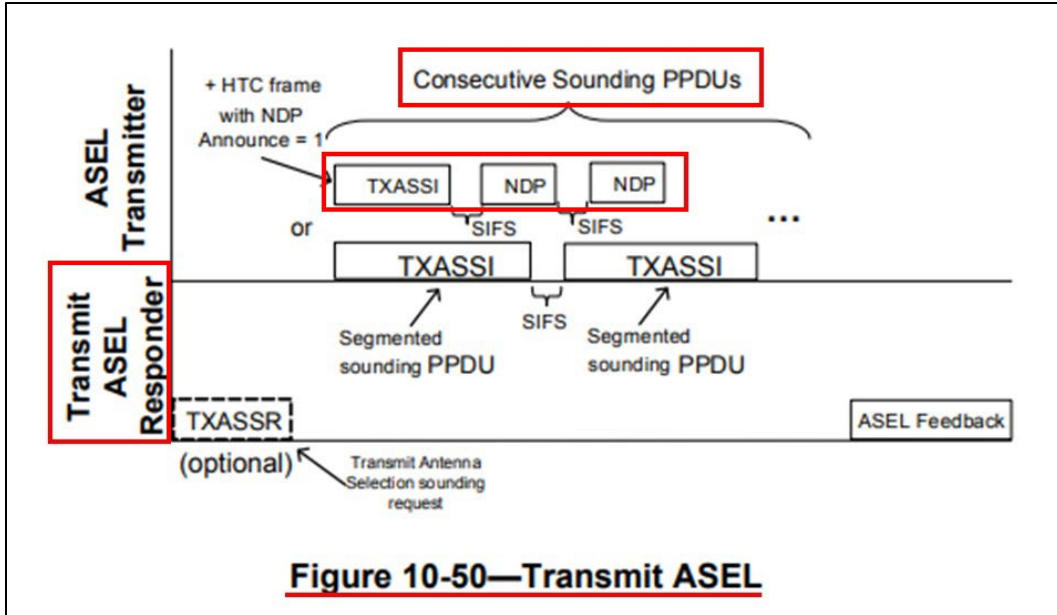

Source: [IEEE 802.11-2016 Standard](#) (Page 1483)

44. PPDUs are MAC frames that include a set of fields. The High Throughput (HT) control field is in the MAC frame format and present only in certain frame types and subtypes. A frame that contains the HT Control Field is referred to as a “+HTC Frame” (“non-ZLF+HTC packet”).

A frame that contains the HT Control field is referred to as a +HTC frame. A Control Wrapper frame is a +HTC frame.

Source: [IEEE 802.11-2016 Standard](#) (Page 637)

### 9.2.3 General frame format

The MAC frame format comprises a set of fields that occur in a fixed order in all frames. Figure 9-1 depicts the general MAC frame format. The first three fields (Frame Control, Duration/ID, and Address 1) and the last field (FCS) in Figure 9-1 constitute the minimal frame format and are present in all frames, including reserved types and subtypes. The fields Address 2, Address 3, Sequence Control, Address 4, QoS Control, HT Control, and Frame Body are present only in certain frame types and subtypes. Each field is defined in 9.2.4. The format of each of the individual subtypes of each frame type is defined in 9.3. The components of management frame bodies are defined in 9.4. The formats of Action frames are defined in 9.6.

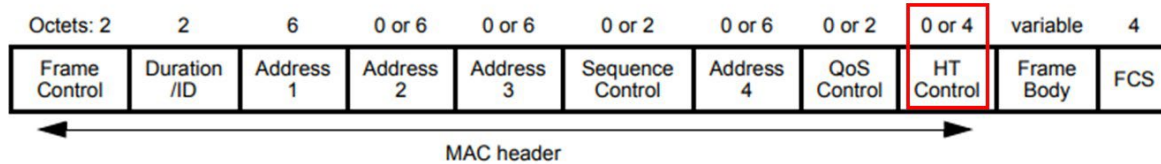

Figure 9-1—MAC frame format

Source: [IEEE 802.11-2016 Standard](#) (Pages 637-38)

45. The +HTC frame includes an LAC subfield, which allows the station to perform antenna selection. The LAC frame format includes the MAI subfield (MCS request or ASEL Indication). When MAI is set to “14,” the MFB/ASELC subfield (MCS Feedback/Antenna Selection Command) is used as the Antenna Selection Command. Also, the frame format of ASEL subfield contains ASEL Command and ASEL Data subfields.

46. As an example, when ASEL Command is “0,” it is interpreted as TXASSI signal (“including a transmit antenna selection sounding indication (TXASSI) signal”), and the ASEL Data field contains the number of remaining sounding PPDU to be transmitted (“a number N of the plural consecutive ZLF sounding packets”). NDP sounding can be indicated by the HT NDP announcement subfield (when set to 1) in the HT Control field.

**null data packet (NDP):** A physical layer (PHY) protocol data unit (PPDU) that carries no Data field.

Source: [IEEE 802.11-2016 Standard](#) (Page 157)

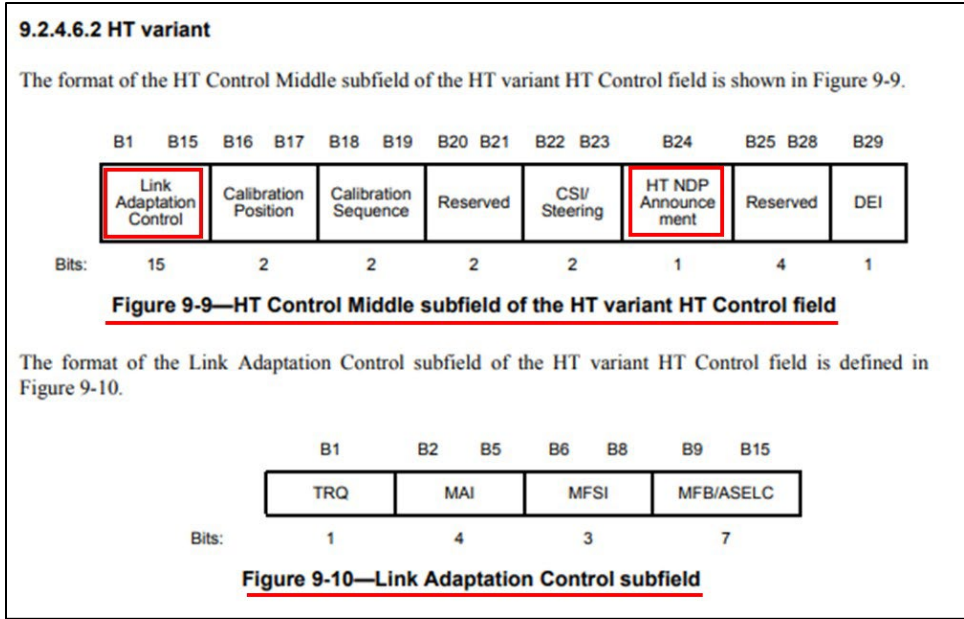

Source: [IEEE 802.11-2016 Standard](#) (Page 655)

**Table 9-12—Subfields of Link Adaptation Control subfield**

Subfield	Meaning	Definition
TRQ	Training request	Set to 1 to request the responder to transmit a sounding PPDU. Set to 0 to indicate that the responder is not requested to transmit a sounding PPDU. See 10.32.2 and 10.34.2.
MAI	MCS request (MRQ) or ASEL indication	Set to 14 (indicating ASEL) to indicate that the MFB/ASEL C subfield is interpreted as ASEL C. Otherwise, the MAI subfield is interpreted as shown in Figure 9-11, and the MFB/ASEL C subfield is interpreted as MCS feedback (MFB).
MFSI	MCS feedback sequence identifier	Set to the received value of MSI contained in the frame to which the MFB information refers. Set to 7 for unsolicited MFB.
MFB/ASEL C	MCS feedback and antenna selection command/data	When the MAI subfield is equal to the value ASEL, this subfield is interpreted as defined in Figure 9-12 and Table 9-14. Otherwise, this subfield contains recommended MFB. A value of 127 indicates that no feedback is present.

The structure of the MAI subfield of the Link Adaptation Control subfield is defined in Figure 9-11. The subfields of the MAI subfield are defined in Table 9-13.

B0	B1	B3
MRQ	MSI	
Bits: 1	3	

**Figure 9-11—MAI subfield**

Source: [IEEE 802.11-2016 Standard](#) (Page 656)



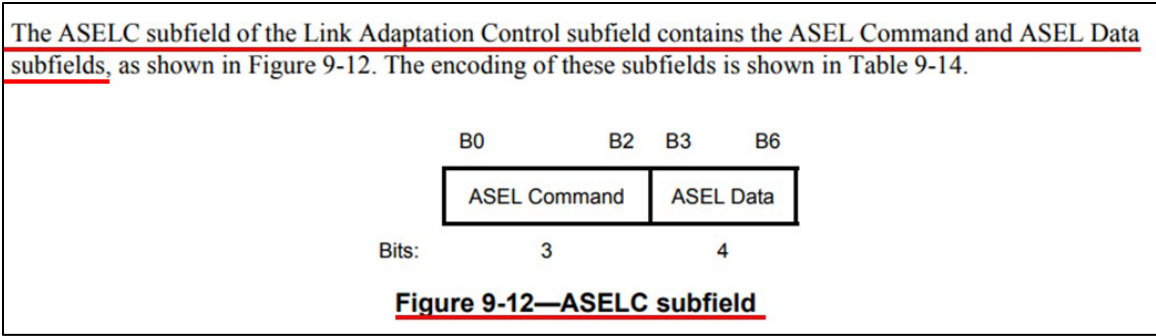

Source: [IEEE 802.11-2016 Standard](#) (Page 657)

NOTE—If the HT variant HT Control field is carried in a sounding PPDU, then the value of the ASEL Data field contains the remaining number of sounding frames following the current one. If null data packet (NDP) sounding frame is used, then the value in the ASEL Data field contains the number of NDPs following a non-NDP+HTC. The HT NDP Announcement subfield in the HT Control field is set to 1 to indicate NDP sounding.

Source: [IEEE 802.11-2016 Standard](#) (Page 657)

<b>Table 9-14—ASEL Command and ASEL Data subfields</b>		
<b>ASEL Command</b>	<b>Interpretation of ASEL Command</b>	<b>ASEL Data</b>
0	Transmit Antenna Selection Sounding Indication (TXASSI)	Number of remaining sounding PPDU's to be transmitted 0 to 15
		See NOTE
1	Transmit Antenna Selection Sounding Request (TXASSR) or Transmit ASEL Sounding Resumption	0 when the command is Transmit ASEL Sounding Request A number in the range 1 to 15, the number being the number of the first sounding PPDU to be transmitted when the command is Transmit ASEL Sounding Resumption, where 0 corresponds to the first sounding PPDU in the original ASEL training sequence
2	Receive Antenna Selection Sounding Indication (RXASSI)	Number of remaining sounding PPDU's to be received 0 to 15
		See NOTE
3	Receive Antenna Selection Sounding Request (RXASSR)	Number of sounding PPDU's required 0 to 15
4	Sounding Label	Sequence number of the sounding PPDU corresponding to a channel state information (CSI) frame in ASEL feedback 0 to 15
5	No Feedback Due to ASEL Training Failure or Stale Feedback	A number in the range 0 to 15, the number being the number of the first sounding PPDU that was not received properly, where 0 corresponds to the first sounding PPDU in the ASEL training sequence, or 0 if no sounding PPDU's were received properly, or 0 if this is a request for a full retraining sequence
6	Transmit Antenna Selection Sounding Indication requesting feedback of explicit CSI (TXASSI-CSI)	Number of remaining sounding PPDU's to be transmitted 0 to 15
		See NOTE
7	Reserved	Reserved

Source: [IEEE 802.11-2016 Standard](#) (Page 657)

The frame exchange sequence for transmit ASEL is shown in Figure 10-50, where the term *ASEL transmitter* identifies the STA that is conducting transmit ASEL, and the term *transmit ASEL responder* identifies the STA that provides ASEL feedback. The frame exchange comprises the following steps:

- a) (Optional) A transmit ASEL responder may initiate the transmit ASEL training by sending a +HTC frame with the ASEL Command subfield set to Transmit Antenna Selection Sounding Request (TXASSR).
- b) The ASEL transmitter sends out consecutive sounding PPDU's separated by SIFS in a TXOP of which it is the TXOP holder with no acknowledgment over different antenna sets, each PPDU containing a +HTC frame with the ASEL Command subfield set to Transmit Antenna Selection Sounding Indication (TXASSI or TXASSI-CSI). Each sounding PPDU is transmitted over one antenna set.

Source: [IEEE 802.11-2016 Standard](#) (Page 1482)

- c) The transmit ASEL responder estimates the subchannel corresponding to each sounding PPDU.
- d) If the ASEL Command subfield in the sounding frames is equal to TXASSI-CSI, after receiving all of the sounding PPDU's, the transmit ASEL responder shall respond with the full size CSI in a subsequent TXOP. If the ASEL Command subfield in the sounding frames is equal to TXASSI, after receiving all of the sounding PPDU's, the transmit ASEL responder may either respond with the full size CSI in a subsequent TXOP, or conduct ASEL computation and provide the selected antenna indices in a subsequent TXOP.
  - 1) CSI is transported using the MIMO CSI Matrices frame defined in 9.6.12.6 contained within either an Action No Ack or Action frame. Multiple CSI frames may be required to provide the complete feedback, in which case the value of the Sounding Timestamp field within each of

Source: [IEEE 802.11-2016 Standard](#) (Page 1482)

An NDP sequence contains at least one HT NDP and at least one PPDU that is not an NDP. Only one PPDU in the NDP sequence may contain an HT NDP announcement. An NDP sequence begins with an HT NDP announcement. The NDP sequence ends at the end of the transmission of the last HT NDP that is announced by the HT NDP announcement. A STA that transmits the first PPDU of an NDP sequence is the NDP sequence owner. In the NDP sequence, only PPDU's carrying HT NDP and PPDU's carrying single MPDU Control frames may follow the NDP sequence's starting PPDU.

Source: [IEEE 802.11-2016 Standard](#) (Pages 1485 & 1486)

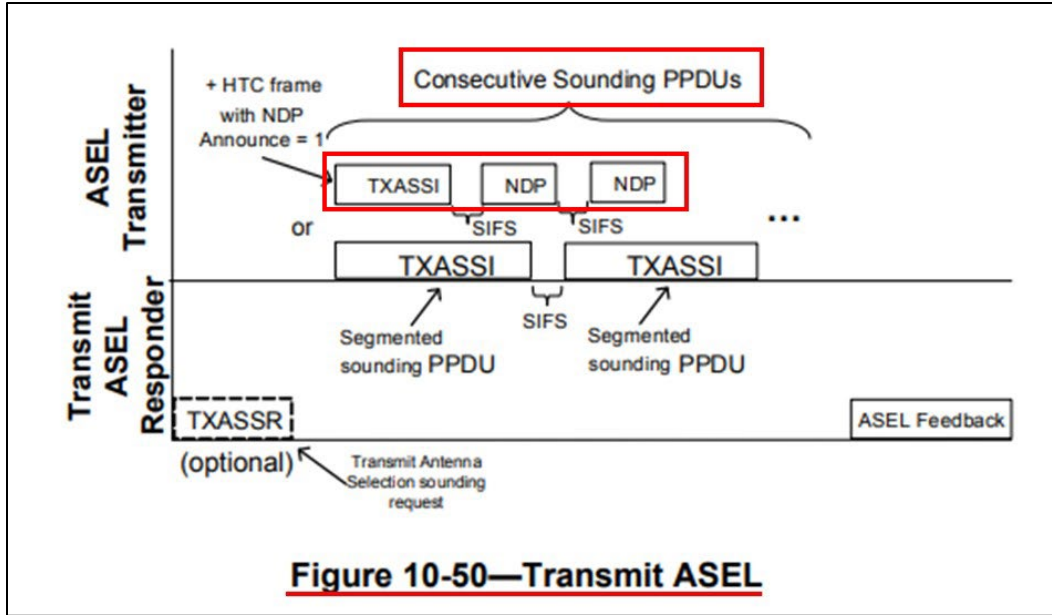

Source: [IEEE 802.11-2016 Standard](#) (Page 1483)

47. The accused products include a station in a multiple-input, multiple-output (MIMO) wireless local area network (WLAN) including a plurality of stations, each station including a set of antennas.

48. For example, the TCL 65S455 Smart TV and the Alcatel LINKZONE 4G LTE Cat4 Mobile Wi-Fi communicate with other stations using the IEEE 802.11 protocol and include a set of antennas that are used for both transmitting and receiving data to and from the other stations over a WLAN. The transmission and reception of data using multiple antennas simultaneously is known as MIMO (“multiple-input, multiple-output”). The stations communicating using MIMO implement the antenna selection process before establishing communication with each other.

# Part 11: Wireless LAN Medium Access Control (MAC) and Physical Layer (PHY) Specifications

## 1. Overview

### 1.1 Scope

The scope of this standard is to define one medium access control (MAC) and several physical layer (PHY) specifications for wireless connectivity for fixed, portable, and moving stations (STAs) within a local area.

Source: [IEEE 802.11-2016 Standard](#) (Page 122)

An HT STA has PHY features consisting of the modulation and coding scheme (MCS) set described in 19.3.5 and physical layer (PHY) protocol data unit (PPDU) formats described in 19.1.4. Some PHY features that distinguish an HT STA from a non-HT STA are referred to as *multiple input, multiple output (MIMO) operation*; spatial multiplexing (SM); spatial mapping (including transmit beamforming); space-time block coding (STBC); low-density parity check (LDPC) encoding; and antenna selection (ASEL). The allowed PPDU formats are non-HT format, HT-mixed format, and HT-greenfield format (see 19.1.4). The PPDUs can be transmitted with 20 MHz bandwidth and might be transmitted with 40 MHz bandwidth.

Source: [IEEE 802.11-2016 Standard](#) (Page 197)

**multiple input, multiple output (MIMO):** A physical layer (PHY) configuration in which both transmitter and receiver use multiple antennas.

Source: [IEEE 802.11-2016 Standard](#) (Page 136)

**multi-user multiple input, multiple output (MU-MIMO):** A technique by which multiple stations (STAs), each with one or more antennas, either simultaneously transmit to a single STA or simultaneously receive from a single STA independent data streams over the same radio frequencies.

NOTE—IEEE Std 802.11 supports only downlink (DL) MU-MIMO. See **downlink multi-user multiple input, multiple output (DL-MU-MIMO)** (in 3.2).

Source: [IEEE 802.11-2016 Standard](#) (Page 136)

## 10.31 Link adaptation

### 10.31.1 Introduction

To fully exploit MIMO channel variations and transmit beamforming on a MIMO link, a STA can request that another STA provide MIMO channel sounding and MFB.

Source: [IEEE 802.11-2016 Standard](#) (Page 1463)

### 10.30 Sounding PPDU

The behavior described in this subclause is specific to the use of the HT variant HT Control field.

A sounding PPDU is a PPDU for which the SOUNDING parameter of the corresponding RXVECTOR or TXVECTOR has the value SOUNDING. Sounding PPDUs are transmitted by STAs to enable the receiving STAs to estimate the channel between the transmitting STA and the receiving STA.

A STA transmits sounding PPDU when it operates in the following roles:

- MFB requester (see 10.31.2)
- HT beamformee responding to a training request, calibration initiator, or responder involved in implicit transmit beamforming (see 10.32.2.2, 10.32.2.3, and 10.32.2.4)
- HT beamformer involved in explicit transmit beamforming (see 10.32.3)
- ASEL transmitter and ASEL sounding-capable transmitter involved in ASEL (see 10.33.2)

A STA receives sounding PPDU when it operates in the following roles:

- MFB responder (see 10.31.2)
- HT beamformer sending a training request, calibration initiator, or responder involved in implicit transmit beamforming (see 10.32.2.2, 10.32.2.3, and 10.32.2.4)
- HT beamformee involved in explicit transmit beamforming (see 10.32.3)
- Transmit ASEL responder and ASEL receiver involved in ASEL (see 10.33.2)

Source: [IEEE 802.11-2016 Standard](#) (Pages 1462-63)

### 10.33 Antenna selection (ASEL)

#### 10.33.1 Introduction

The procedures in this subclause apply only to HT and non-HT PPDU for which the HT Control field, if present, is the HT variant HT Control field.

ASEL is a time-variant mapping of the signals at the RF chains onto a set of antenna elements when the number of RF chains is smaller than the number of antenna elements. The mapping might be chosen based on instantaneous or averaged CSI. ASEL requires the training of the full size channel associated with all antenna elements, which is obtained by transmitting or receiving sounding PPDU over all antennas. These sounding PPDU should be sent within a single TXOP. To avoid channel distortions, these sounding PPDU shall be transmitted consecutively. The training information is exchanged using the HT Control field. When both transmitter and receiver have ASEL capabilities, training of transmit and receive antennas might be done one after another. ASEL supports up to eight antennas and up to four RF chains.

Source: [IEEE 802.11-2016 Standard](#) (Page 1481)

49. The accused products include a receiver configured to receive, via a channel, plural consecutive packets including plural sounding packets, each sounding packet corresponding to a different subset of the set of antennas, and at least one of the plural

consecutive packets including (i) a high throughput (HT) control field including a signal to initiate antenna selection and (ii) a number N indicative of a number of sounding packets which follow the at least one packet including the HT control field and which are to be used for antenna selection.

50. For example, during the antenna selection process, the stations receive multiple consecutive sounding PPDU ("plural sounding packets"). Each sounding PPDU corresponds to a different set of antennas from the available antennas. The first PPDU frame received is a +HTC frame followed by consecutive NDP (Null Data Packet) frames.

### 10.30 Sounding PPDU

The behavior described in this subclause is specific to the use of the HT variant HT Control field.

A sounding PPDU is a PPDU for which the SOUNDING parameter of the corresponding RXVECTOR or TXVECTOR has the value SOUNDING. Sounding PPDU are transmitted by STAs to enable the receiving STAs to estimate the channel between the transmitting STA and the receiving STA.

A STA transmits sounding PPDU when it operates in the following roles:

- MFB requester (see 10.31.2)
- HT beamformee responding to a training request, calibration initiator, or responder involved in implicit transmit beamforming (see 10.32.2.2, 10.32.2.3, and 10.32.2.4)
- HT beamformer involved in explicit transmit beamforming (see 10.32.3)
- ASEL transmitter and ASEL sounding-capable transmitter involved in ASEL (see 10.33.2)

A STA receives sounding PPDU when it operates in the following roles:

- MFB responder (see 10.31.2)
- HT beamformer sending a training request, calibration initiator, or responder involved in implicit transmit beamforming (see 10.32.2.2, 10.32.2.3, and 10.32.2.4)
- HT beamformee involved in explicit transmit beamforming (see 10.32.3)
- Transmit ASEL responder and ASEL receiver involved in ASEL (see 10.33.2)

Source: [IEEE 802.11-2016 Standard](#) (Pages 1462-63)

### 10.33 Antenna selection (ASEL)

#### 10.33.1 Introduction

The procedures in this subclause apply only to HT and non-HT PPDU for which the HT Control field, if present, is the HT variant HT Control field.

ASEL is a time-variant mapping of the signals at the RF chains onto a set of antenna elements when the number of RF chains is smaller than the number of antenna elements. The mapping might be chosen based on instantaneous or averaged CSI. ASEL requires the training of the full size channel associated with all antenna elements, which is obtained by transmitting or receiving sounding PPDU over all antennas. These sounding PPDU should be sent within a single TXOP. To avoid channel distortions, these sounding PPDU shall be transmitted consecutively. The training information is exchanged using the HT Control field. When both transmitter and receiver have ASEL capabilities, training of transmit and receive antennas might be done one after another. ASEL supports up to eight antennas and up to four RF chains.

Source: [IEEE 802.11-2016 Standard](#) (Page 1481)

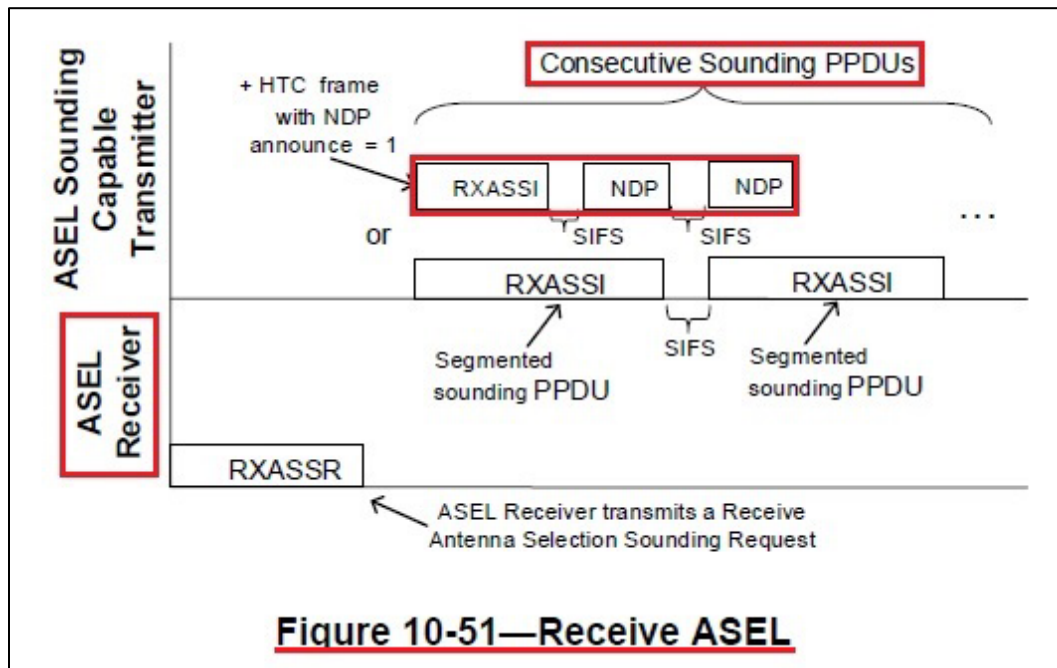

Source: [IEEE 802.11-2016 Standard](#) (Page 1484)

51. These sounding PPDU's are Media Access Control (MAC) frames that comprise a set of fields, which can include a High Throughput (HT) control field. A frame that contains the HT Control field is referred to as "+HTC Frame." The HT Control field of a MAC frame can be of two types: High Throughput (HT) or Very High Throughput (VHT). The antenna selection procedure applies to HT PPDU's (e.g., PPDU's that have a HT variant HT control field).

**9.2.3 General frame format**

The MAC frame format comprises a set of fields that occur in a fixed order in all frames. Figure 9-1 depicts the general MAC frame format. The first three fields (Frame Control, Duration/ID, and Address 1) and the last field (FCS) in Figure 9-1 constitute the minimal frame format and are present in all frames, including reserved types and subtypes. The fields Address 2, Address 3, Sequence Control, Address 4, QoS Control, HT Control, and Frame Body are present only in certain frame types and subtypes. Each field is defined in 9.2.4. The format of each of the individual subtypes of each frame type is defined in 9.3. The components of management frame bodies are defined in 9.4. The formats of Action frames are defined in 9.6.

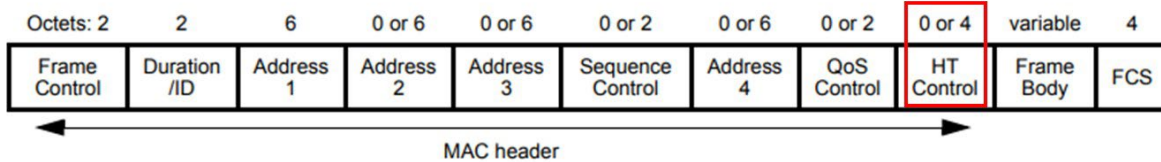

**Figure 9-1—MAC frame format**

Source: [IEEE 802.11-2016 Standard](#) (Pages 637-38)

A frame that contains the HT Control field is referred to as a *+HTC frame*. A Control Wrapper frame is a +HTC frame.

Source: [IEEE 802.11-2016 Standard](#) (Page 637)



### 9.2.4.6 HT Control field

#### 9.2.4.6.1 General

The HT Control field is always present in a Control Wrapper frame and is present in QoS Data and Management frames as determined by the +HTC/Order subfield of the Frame Control field as defined in 9.2.4.1.10.

NOTE—The only control frame subtype for which HT Control field is present is the Control Wrapper frame. A Control frame that is described as +HTC (e.g., an RTS+HTC, CTS+HTC, BlockAck+HTC or BlockAckReq+HTC frame) implies the use of the Control Wrapper frame to carry that Control frame.

The format of the 4-octet HT Control field is shown in Figure 9-8.

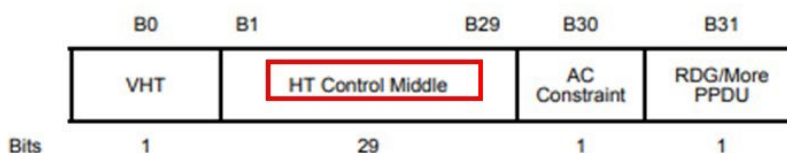

**Figure 9-8—HT Control field**

The HT Control field has two forms, the HT variant and the VHT variant. The two forms differ in the format of the HT Control Middle subfield, described in 9.2.4.6.2 for the HT variant and in 9.2.4.6.3 for the VHT variant and in the value of the VHT subfield.

The VHT subfield of the HT Control field indicates whether the HT Control Middle subfield is the VHT Variant or the HT Variant. The VHT subfield is set to 1 to indicate that the HT Control Middle subfield is the VHT Variant and is set to 0 to indicate that the HT Control Middle subfield is the HT Variant.

Source: [IEEE 802.11-2016 Standard](#) (Page 654)

### 10.33 Antenna selection (ASEL)

#### 10.33.1 Introduction

The procedures in this subclause apply only to HT and non-HT PPDU for which the HT Control field, if present, is the HT variant HT Control field.

ASEL is a time-variant mapping of the signals at the RF chains onto a set of antenna elements when the number of RF chains is smaller than the number of antenna elements. The mapping might be chosen based on instantaneous or averaged CSI. ASEL requires the training of the full size channel associated with all antenna elements, which is obtained by transmitting or receiving sounding PPDU over all antennas. These sounding PPDU should be sent within a single TXOP. To avoid channel distortions, these sounding PPDU shall be transmitted consecutively. The training information is exchanged using the HT Control field. When both transmitter and receiver have ASEL capabilities, training of transmit and receive antennas might be done one after another. ASEL supports up to eight antennas and up to four RF chains.

Source: [IEEE 802.11-2016 Standard](#) (Page 1481)

52. The +HTC frames (“at least one of the plural consecutive packets”) contain the HT variant HT Control field. The HT Control field also contains a HT control middle subfield,

which further contains an LAC subfield. The LAC subfield allows the station to perform Antenna Selection. The LAC frame format includes the MAI (MCS request or ASEL Indication) subfield and the MFB/ASEL (MCS Feedback/Antenna Selection Command) subfield. If the MAI subfield is set to “14,” the MFB/ASEL subfield acts as the Antenna Selection Command, and the frame format of ASEL subfield contains ASEL Command and ASEL Data subfields.

53. As one example, if the ASEL Command of the LAC frame is set to “2,” it is interpreted as RXASSI (“Receive Antenna Selection Sounding Indication”), a signal to initiate antenna selection. And the ASEL Data field contains the remaining number of sounding PPDUs to be received (“a number N indicative of a number of sounding packets”).

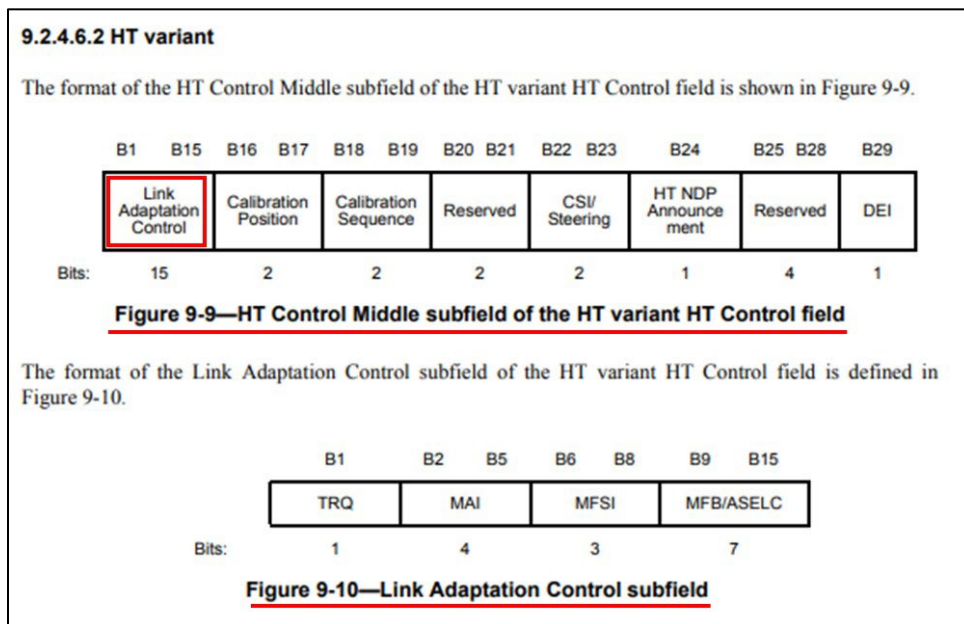

Source: [IEEE 802.11-2016 Standard](#) (Page 655)

**Table 9-12—Subfields of Link Adaptation Control subfield**

Subfield	Meaning	Definition
TRQ	Training request	Set to 1 to request the responder to transmit a sounding PPDU. Set to 0 to indicate that the responder is not requested to transmit a sounding PPDU. See 10.32.2 and 10.34.2.
MAI	MCS request (MRQ) or ASEL indication	Set to 14 (indicating ASEL) to indicate that the MFB/ASEL subfield is interpreted as ASEL. Otherwise, the MAI subfield is interpreted as shown in Figure 9-11, and the MFB/ASEL subfield is interpreted as MCS feedback (MFB).
MFSI	MCS feedback sequence identifier	Set to the received value of MSI contained in the frame to which the MFB information refers. Set to 7 for unsolicited MFB.
MFB/ASEL	MCS feedback and antenna selection command/data	When the MAI subfield is equal to the value ASEL, this subfield is interpreted as defined in Figure 9-12 and Table 9-14. Otherwise, this subfield contains recommended MFB. A value of 127 indicates that no feedback is present.

The structure of the MAI subfield of the Link Adaptation Control subfield is defined in Figure 9-11. The subfields of the MAI subfield are defined in Table 9-13.

B0            B1                            B3

MRQ	MSI
-----	-----

Bits:            1                                    3

**Figure 9-11—MAI subfield**

Source: [IEEE 802.11-2016 Standard](#) (Page 656)

The ASEL subfield of the Link Adaptation Control subfield contains the ASEL Command and ASEL Data subfields, as shown in Figure 9-12. The encoding of these subfields is shown in Table 9-14.

B0                            B2    B3            B6

ASEL Command	ASEL Data
--------------	-----------

Bits:                            3                                    4

**Figure 9-12—ASELC subfield**

Source: [IEEE 802.11-2016 Standard](#) (Page 657)

ASEL Command	Interpretation of ASEL Command	ASEL Data
0	Transmit Antenna Selection Sounding Indication (TXASSI)	Number of remaining sounding PPDU's to be transmitted 0 to 15
		See NOTE
1	Transmit Antenna Selection Sounding Request (TXASSR) or Transmit ASEL Sounding Resumption	0 when the command is Transmit ASEL Sounding Request A number in the range 1 to 15, the number being the number of the first sounding PPDU to be transmitted when the command is Transmit ASEL Sounding Resumption, where 0 corresponds to the first sounding PPDU in the original ASEL training sequence
2	Receive Antenna Selection Sounding Indication (RXASSI)	Number of remaining sounding PPDU's to be received 0 to 15
		See NOTE
3	Receive Antenna Selection Sounding Request (RXASSR)	Number of sounding PPDU's required 0 to 15
4	Sounding Label	Sequence number of the sounding PPDU corresponding to a channel state information (CSI) frame in ASEL feedback 0 to 15
5	No Feedback Due to ASEL Training Failure or Stale Feedback	A number in the range 0 to 15, the number being the number of the first sounding PPDU that was not received properly, where 0 corresponds to the first sounding PPDU in the ASEL training sequence, or 0 if no sounding PPDU's were received properly, or 0 if this is a request for a full retraining sequence
6	Transmit Antenna Selection Sounding Indication requesting feedback of explicit CSI (TXASSI-CSI)	Number of remaining sounding PPDU's to be transmitted 0 to 15
		See NOTE
7	Reserved	Reserved
<p>NOTE—If the HT variant HT Control field is carried in a sounding PPDU, then the value of the ASEL Data field contains the remaining number of sounding frames following the current one. If null data packet (NDP) sounding frame is used, then the value in the ASEL Data field contains the number of NDP's following a non-NDP+HTC. The HT NDP Announcement subfield in the HT Control field is set to 1 to indicate NDP sounding.</p>		

Source: [IEEE 802.11-2016 Standard](#) (Page 657)

**Table 9-14—ASEL Command and ASEL Data subfields**

ASEL Command	Interpretation of ASEL Command	ASEL Data
0	Transmit Antenna Selection Sounding Indication (TXASSI)	Number of remaining sounding PPDU's to be transmitted 0 to 15  See NOTE
1	Transmit Antenna Selection Sounding Request (TXASSR) or Transmit ASEL Sounding Resumption	0 when the command is Transmit ASEL Sounding Request A number in the range 1 to 15, the number being the number of the first sounding PPDU to be transmitted when the command is Transmit ASEL Sounding Resumption, where 0 corresponds to the first sounding PPDU in the original ASEL training sequence
2	Receive Antenna Selection Sounding Indication (RXASSI)	Number of remaining sounding PPDU's to be received 0 to 15  See NOTE
3	Receive Antenna Selection Sounding Request (RXASSR)	Number of sounding PPDU's required 0 to 15
4	Sounding Label	Sequence number of the sounding PPDU corresponding to a channel state information (CSI) frame in ASEL feedback 0 to 15
5	No Feedback Due to ASEL Training Failure or Stale Feedback	A number in the range 0 to 15, the number being the number of the first sounding PPDU that was not received properly, where 0 corresponds to the first sounding PPDU in the ASEL training sequence, or 0 if no sounding PPDU's were received properly, or 0 if this is a request for a full retraining sequence
6	Transmit Antenna Selection Sounding Indication requesting feedback of explicit CSI (TXASSI-CSI)	Number of remaining sounding PPDU's to be transmitted 0 to 15  See NOTE
7	Reserved	Reserved
<p><b>NOTE</b>—If the HT variant HT Control field is carried in a sounding PPDU, then the value of the ASEL Data field contains the remaining number of sounding frames following the current one. If null data packet (NDP) sounding frame is used, then the value in the ASEL Data field contains the number of NDPs following a non-NDP+HTC. The HT NDP Announcement subfield in the HT Control field is set to 1 to indicate NDP sounding.</p>		

Source: [IEEE 802.11-2016 Standard](#) (Page 657)

54. The accused products include an estimating unit configured to estimate a channel matrix based on a characteristic of the channel as indicated by the received N sounding packets.

55. For example, the ASEL receiver station receives the sounding PPDU's ("N sounding packets"). The ASEL receiver station then estimates the channel state information ("a characteristic of the channel") based on the measurements from the received sounding PPDU's, each of which corresponds to a different set of antennas. After the estimate is complete, a Channel State Information report (CSI report) is generated. The CSI report is part of the CSI frame format, and is present as a CSI Report field. The CSI Report field contains a Channel Matrix subfield, which contains the channel matrices estimated for the different channels.

**19.3.13.3 Sounding PPDU for calibration**

In the case of a bidirectional calibration exchange, two STAs exchange sounding PPDU, the exchange of which enables the receiving STA to compute an estimate of the MIMO channel matrix  $H_k$  for each subcarrier  $k$ . In general, in an exchange of calibration messages, the number of spatial streams is less than the number of transmit antennas. In such cases, HT-ELTFs are used. In the case of sounding PPDU for calibration, the antenna mapping matrix shall be as shown in Equation (19-86).

$$Q_k = C_{CSD}(k)P_{CAL} \quad (19-86)$$

Source: [IEEE 802.11-2016 Standard](#) (Page 2401)

**10.30 Sounding PPDU**

The behavior described in this subclause is specific to the use of the HT variant HT Control field.

A sounding PPDU is a PPDU for which the SOUNDING parameter of the corresponding RXVECTOR or TXVECTOR has the value SOUNDING. Sounding PPDU are transmitted by STAs to enable the receiving STAs to estimate the channel between the transmitting STA and the receiving STA.

A STA transmits sounding PPDU when it operates in the following roles:

- MFB requester (see 10.31.2)
- HT beamformee responding to a training request, calibration initiator, or responder involved in implicit transmit beamforming (see 10.32.2.2, 10.32.2.3, and 10.32.2.4)
- HT beamformer involved in explicit transmit beamforming (see 10.32.3)
- ASEL transmitter and ASEL sounding-capable transmitter involved in ASEL (see 10.33.2)

A STA receives sounding PPDU when it operates in the following roles:

- MFB responder (see 10.31.2)
- HT beamformer sending a training request, calibration initiator, or responder involved in implicit transmit beamforming (see 10.32.2.2, 10.32.2.3, and 10.32.2.4)
- HT beamformee involved in explicit transmit beamforming (see 10.32.3)
- Transmit ASEL responder and ASEL receiver involved in ASEL (see 10.33.2)

Source: [IEEE 802.11-2016 Standard](#) (Pages 1462-63)

The frame exchange sequence for receive ASEL is shown in Figure 10-51, where the term *ASEL receiver* identifies the STA that is conducting receive ASEL, and the term *ASEL sounding-capable transmitter* identifies the STA sending the consecutive sounding PPDU used for receive ASEL calculations. The frame exchange comprises the following steps:

- The ASEL receiver transmits a +HTC frame with the MAI subfield set to ASELI, the ASEL Command subfield set to Receive Antenna Selection Sounding Request (RXASSR), and the ASEL Data subfield set to the number of sounding PPDU's required.

NOTE— For example, in the case of sounding over all disjointed antenna sets, the number of total consecutive sounding PPDU's or NDPs equals the smallest integer that is greater than or equal to the number of antennas divided by the number of RF chains.

- The ASEL sounding-capable transmitter responds with the corresponding number of sounding PPDU's in its subsequent TXOP. These PPDU's are separated by SIFS. When using non-NDP sounding, each PPDU contains a +HTC frame in which the MAI subfield is set to ASELI, the ASEL Command subfield is set to Receive Antenna Selection Sounding Indication (RXASSI), and the ASEL Data subfield is set to the remaining number of sounding PPDU's to be transmitted. When using NDP sounding, the PPDU that precedes the first NDP contains a +HTC frame in which the NDP Announce field is set to 1, the MAI subfield is set to ASELI, the ASEL Command subfield is set to RXASSI, and the ASEL Data subfield is set to the remaining number of sounding PPDU's to be transmitted.

Source: [IEEE 802.11-2016 Standard](#) (Page 1484)

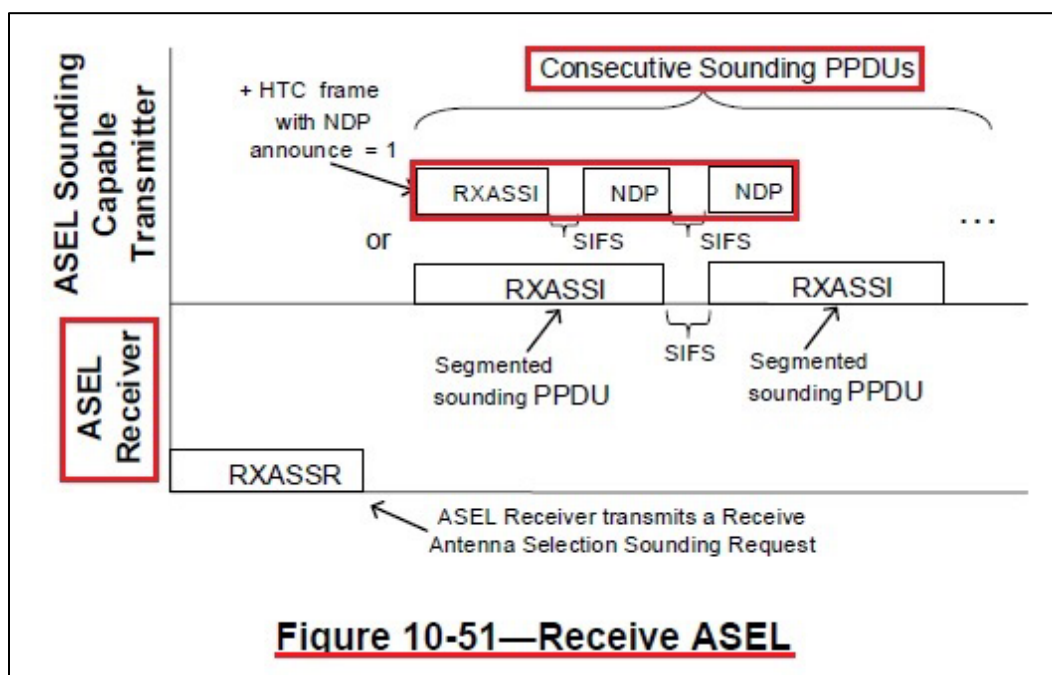

Source: [IEEE 802.11-2016 Standard](#) (Page 1484)

When the MIMO channel measurements become available at STA B, STA B shall send one or more CSI frames that contain the CSI report (Step 2 in Figure 10-47). This CSI report shall have full precision, i.e.  $N_g=1$  (no grouping) and  $N_b=3$  (8 bits). In these CSI frames, the Calibration Sequence subfields in HT Control fields shall be set to the same value that is indicated in the Calibration Sounding Complete frame. These CSI frames shall have a frame type of Management Action +HTC.

Source: [IEEE 802.11-2016 Standard](#) (Page 1477)

**9.6.12.6 CSI frame format**

The CSI frame is an Action or an Action No Ack frame of category HT. The format of its Action field is defined in Table 9-338.

**Table 9-338—CSI frame Action field format**

Order	Information
1	Category
2	HT Action
3	MIMO Control (see 9.4.1.27)
4	<u>CSI Report</u> (see 9.4.1.28)

Source: [IEEE 802.11-2016 Standard](#) (Page 1214)

**9.4.1.28 CSI Report field**

The CSI Report field is used by the CSI frame (see 9.6.12.6) to carry explicit channel state information to a transmit HT beamformer, as described in 10.32.3.

The CSI Matrix subfields in the CSI Report field shown in Table 9-52 and Table 9-53 are matrices whose elements are taken from the CHAN\_MAT parameter of RXVECTOR (see Table 19-1).

**Table 9-52—CSI Report field (20 MHz)**

Field	Size (bits)	Meaning
SNR in receive chain 1	8	Signal-to-noise ratio in the first receive chain of the STA sending the report.
...		
SNR in receive chain $N_r$	8	Signal-to-noise ratio in the $N_r$ 'th receive chain of the STA sending the report.
<u>CSI Matrix for carrier -28</u>	$3+2 \times N_b \times N_c \times N_r$	<u>CSI matrix (see Figure 9-95)</u>
...		

Source: [IEEE 802.11-2016 Standard](#) (Page 746)



Parameter	Condition	Value	TXVECTOR	RXVECTOR
			See NOTE 1	
CHAN_MAT	CHAN_MAT_TYPE is COMPRESSED_SV	Contains a set of compressed beamforming feedback matrices as defined in 19.3.12.3.6 based on the channel measured during the training symbols of the received PPDU. The number of elements depends on the number of spatial streams and the number of transmit chains.	N	Y
	CHAN_MAT_TYPE is NON_COMPRESSED_SV	Contains a set of noncompressed beamforming feedback matrices as defined in 19.3.12.3.5 based on the channel measured during the training symbols of the received PPDU. The number of complex elements is $N_{ST} \times N_r \times N_c$ where $N_{ST}$ is the total number of subcarriers, $N_c$ is the number of columns, and $N_r$ is the number of rows in each matrix.	N	Y
	CHAN_MAT_TYPE is CSI_MATRICES	Contains a set of CSI matrices as defined in 19.3.12.3.2 based on the channel measured during the training symbols of the received PPDU. The number of complex elements is $N_{ST} \times N_r \times N_c$ where $N_{ST}$ is the total number of subcarriers, $N_c$ is the number of columns, and $N_r$ is the number of rows in each matrix.	N	Y
	Otherwise	Not present	N	N
CHAN_MAT_TYPE	FORMAT is HT_MF or HT_GF	Enumerated type: COMPRESSED_SV indicates that CHAN_MAT is a set of compressed beamforming vector matrices. NON_COMPRESSED_SV indicates that CHAN_MAT is a set of noncompressed beamforming vector matrices. <u>CSI_MATRICES indicates that CHAN_MAT is a set of channel state matrices.</u>	N	Y
	Otherwise	Not present	N	N

Source: [IEEE 802.11-2016 Standard](#) (Pages 2340-41)

56. The accused products include a selecting unit configured to select a subset of antennas according to the channel matrix, wherein the receiver is further configured to receive a non-ZLF+HTC control packet immediately followed by plural consecutive zero length frame (ZLF) sounding packets, the non-ZLF+HTC packet having an antenna selection control (ASC) field including a receive antenna selection sounding indication (RXASSI) signal to initiate antenna selection and a number N of the plural consecutive ZLF sounding packets.

57. For example, the ASEL receiver station, after receiving the consecutive sounding packets, estimates the Channel State Information (CSI) and generates a Channel State Information report (CSI report), which includes channel matrices. Based on the channel

matrices, the set of antennas to be used for MIMO communication is selected (“select a subset of antennas”).

58. During the antenna selection process, the ASEL sounding-capable transmitter station transmits consecutive sounding PPDU in which at least one of the PPDU contains a +HTC frame (“non-ZLF+HTC packet”), with the ASEL Command subfield set to RXASSI (“Receive Antenna Selection Sounding Indication”). After receiving all the sounding PPDU, e.g., sounding NDPs (“plural consecutive zero length frame (ZLF) sounding packets”) at the ASEL receiver, channel state information for all channels is measured, and the channel matrix is estimated. Based on the estimated channel matrix, the ASEL receiver performs antenna selection.

**Antenna Selection.** There are  $M$  columns and  $N$  rows in the CSI matrix  $\mathbf{H}$ ; each corresponds to one transmit or receive antenna. To compute the Effective CSI that would be used under a particular antenna selection, we simply pick the subset of rows and columns that correspond to the desired antennas. Note that this includes both transmit antenna selection (e.g., when  $S < M$ , pick the best  $S$  of the  $M$  transmit antennas to send with) and receive antenna selection (e.g., when  $N > S$ , turn off the least useful of the excess antennas in order to reduce power consumption).

Source: <https://arxiv.org/ftp/arxiv/papers/1301/1301.6644.pdf> (Page 76)

## 10.33 Antenna selection (ASEL)

### 10.33.1 Introduction

The procedures in this subclause apply only to HT and non-HT PPDU for which the HT Control field, if present, is the HT variant HT Control field.

ASEL is a time-variant mapping of the signals at the RF chains onto a set of antenna elements when the number of RF chains is smaller than the number of antenna elements. The mapping might be chosen based on instantaneous or averaged CSI. ASEL requires the training of the full size channel associated with all antenna elements, which is obtained by transmitting or receiving sounding PPDU over all antennas. These sounding PPDU should be sent within a single TXOP. To avoid channel distortions, these sounding PPDU shall be transmitted consecutively. The training information is exchanged using the HT Control field. When both transmitter and receiver have ASEL capabilities, training of transmit and receive antennas might be done one after another. ASEL supports up to eight antennas and up to four RF chains.

Source: [IEEE 802.11-2016 Standard](#) (Page 1481)

The frame exchange sequence for receive ASEL is shown in Figure 10-51, where the term *ASEL receiver* identifies the STA that is conducting receive ASEL, and the term *ASEL sounding-capable transmitter* identifies the STA sending the consecutive sounding PPDU used for receive ASEL calculations. The frame exchange comprises the following steps:

- The ASEL receiver transmits a +HTC frame with the MAI subfield set to ASEL, the ASEL Command subfield set to Receive Antenna Selection Sounding Request (RXASSR), and the ASEL Data subfield set to the number of sounding PPDU required.

NOTE— For example, in the case of sounding over all disjointed antenna sets, the number of total consecutive sounding PPDU or NDP equals the smallest integer that is greater than or equal to the number of antennas divided by the number of RF chains.

- The ASEL sounding-capable transmitter responds with the corresponding number of sounding PPDU in its subsequent TXOP. These PPDU are separated by SIFS. When using non-NDP sounding, each PPDU contains a +HTC frame in which the MAI subfield is set to ASEL, the ASEL Command subfield is set to Receive Antenna Selection Sounding Indication (RXASSI), and the ASEL Data subfield is set to the remaining number of sounding PPDU to be transmitted. When using NDP sounding, the PPDU that precedes the first NDP contains a +HTC frame in which the NDP Announce field is set to 1, the MAI subfield is set to ASEL, the ASEL Command subfield is set to RXASSI, and the ASEL Data subfield is set to the remaining number of sounding PPDU to be transmitted.

Source: [IEEE 802.11-2016 Standard](#) (Page 1484)

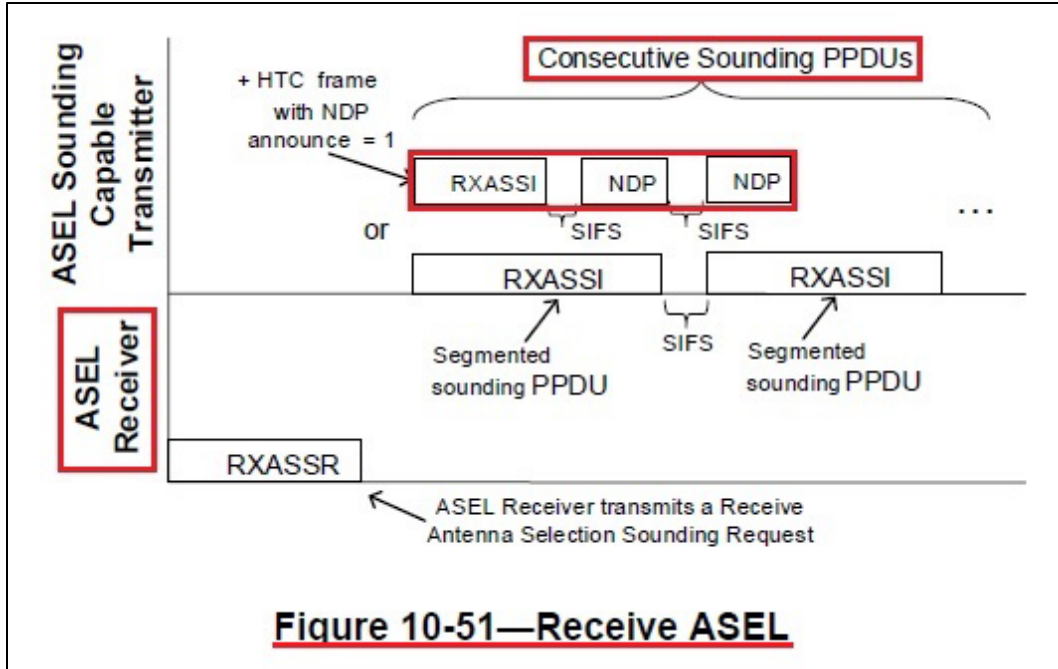

Source: [IEEE 802.11-2016 Standard](#) (Page 1484)

The ASEL receiver uses different antenna sets to receive these sounding PPDU's, estimates CSI after receiving all these sounding PPDU's, and conducts the ASEL.

Source: [IEEE 802.11-2016 Standard](#) (Page 1484)

When the MIMO channel measurements become available at STA B, STA B shall send one or more CSI frames that contain the CSI report (Step 2 in Figure 10-47). This CSI report shall have full precision, i.e.,  $N_g=1$  (no grouping) and  $N_b=3$  (8 bits). In these CSI frames, the Calibration Sequence subfields in HT Control fields shall be set to the same value that is indicated in the Calibration Sounding Complete frame. These CSI frames shall have a frame type of Management Action +HTC.

Source: [IEEE 802.11-2016 Standard](#) (Page 1477)

**9.6.12.6 CSI frame format**

The CSI frame is an Action or an Action No Ack frame of category HT. The format of its Action field is defined in Table 9-338.

**Table 9-338—CSI frame Action field format**

Order	Information
1	Category
2	HT Action
3	MIMO Control (see 9.4.1.27)
4	<u>CSI Report</u> (see 9.4.1.28)

Source: [IEEE 802.11-2016 Standard](#) (Page 1214)

**9.4.1.28 CSI Report field**

The CSI Report field is used by the CSI frame (see 9.6.12.6) to carry explicit channel state information to a transmit HT beamformer, as described in 10.32.3.

The CSI Matrix subfields in the CSI Report field shown in Table 9-52 and Table 9-53 are matrices whose elements are taken from the CHAN\_MAT parameter of RXVECTOR (see Table 19-1).

**Table 9-52—CSI Report field (20 MHz)**

Field	Size (bits)	Meaning
SNR in receive chain 1	8	Signal-to-noise ratio in the first receive chain of the STA sending the report.
...		
SNR in receive chain $N_r$	8	Signal-to-noise ratio in the $N_r$ 'th receive chain of the STA sending the report.
<u>CSI Matrix for carrier -28</u>	$3+2 \times N_b \times N_c \times N_r$	<u>CSI matrix (see Figure 9-95)</u>
...		

Source: [IEEE 802.11-2016 Standard](#) (Page 746)

**Table 19-1—TXVECTOR and RXVECTOR parameters**

Parameter	Condition	Value	TXVECTOR	RXVECTOR
			See NOTE 1	
CHAN_MAT	CHAN_MAT_TYPE is COMPRESSED_SV	Contains a set of compressed beamforming feedback matrices as defined in 19.3.12.3.6 based on the channel measured during the training symbols of the received PPDU. The number of elements depends on the number of spatial streams and the number of transmit chains.	N	Y
	CHAN_MAT_TYPE is NON_COMPRESSED_SV	Contains a set of noncompressed beamforming feedback matrices as defined in 19.3.12.3.5 based on the channel measured during the training symbols of the received PPDU. The number of complex elements is $N_{ST} \times N_r \times N_c$ where $N_{ST}$ is the total number of subcarriers, $N_c$ is the number of columns, and $N_r$ is the number of rows in each matrix.	N	Y
	CHAN_MAT_TYPE is CSI_MATRICES	Contains a set of CSI matrices as defined in 19.3.12.3.2 based on the channel measured during the training symbols of the received PPDU. The number of complex elements is $N_{ST} \times N_r \times N_c$ where $N_{ST}$ is the total number of subcarriers, $N_c$ is the number of columns, and $N_r$ is the number of rows in each matrix.	N	Y
	Otherwise	Not present	N	N
CHAN_MAT_TYPE	FORMAT is HT_MF or HT_GF	Enumerated type: COMPRESSED_SV indicates that CHAN_MAT is a set of compressed beamforming vector matrices. NON_COMPRESSED_SV indicates that CHAN_MAT is a set of noncompressed beamforming vector matrices. <u>CSI_MATRICES indicates that CHAN_MAT is a set of channel state matrices.</u>	N	Y
	Otherwise	Not present	N	N

Source: [IEEE 802.11-2016 Standard](#) (Pages 2340-41)

59. PPDUs are MAC frames that include a set of fields. The High Throughput (HT) control field is in the MAC frame format and present only in certain frame types and subtypes. A frame that contains the HT Control Field is referred to as a “+HTC Frame” (“non-ZLF+HTC packet”).

A frame that contains the HT Control field is referred to as a +HTC frame. A Control Wrapper frame is a +HTC frame.

Source: [IEEE 802.11-2016 Standard](#) (Page 637)

**9.2.3 General frame format**

The MAC frame format comprises a set of fields that occur in a fixed order in all frames. Figure 9-1 depicts the general MAC frame format. The first three fields (Frame Control, Duration/ID, and Address 1) and the last field (FCS) in Figure 9-1 constitute the minimal frame format and are present in all frames, including reserved types and subtypes. The fields Address 2, Address 3, Sequence Control, Address 4, QoS Control, HT Control, and Frame Body are present only in certain frame types and subtypes. Each field is defined in 9.2.4. The format of each of the individual subtypes of each frame type is defined in 9.3. The components of management frame bodies are defined in 9.4. The formats of Action frames are defined in 9.6.

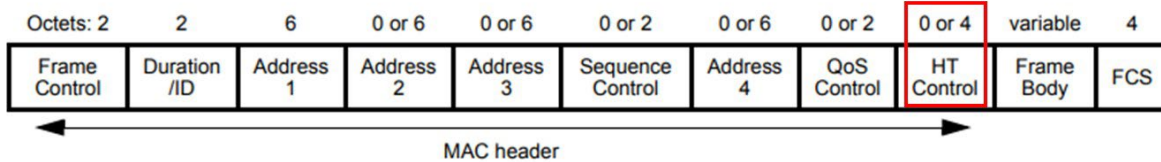

**Figure 9-1—MAC frame format**

Source: [IEEE 802.11-2016 Standard](#) (Pages 637-38)

**9.2.4.6 HT Control field**

**9.2.4.6.1 General**

The HT Control field is always present in a Control Wrapper frame and is present in QoS Data and Management frames as determined by the +HTC/Order subfield of the Frame Control field as defined in 9.2.4.1.10.

NOTE—The only control frame subtype for which HT Control field is present is the Control Wrapper frame. A Control frame that is described as +HTC (e.g., an RTS+HTC, CTS+HTC, BlockAck+HTC or BlockAckReq+HTC frame) implies the use of the Control Wrapper frame to carry that Control frame.

The format of the 4-octet HT Control field is shown in Figure 9-8.

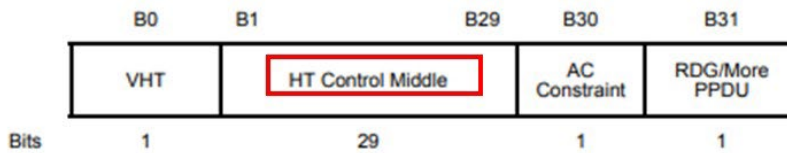

**Figure 9-8—HT Control field**

The HT Control field has two forms, the HT variant and the VHT variant. The two forms differ in the format of the HT Control Middle subfield, described in 9.2.4.6.2 for the HT variant and in 9.2.4.6.3 for the VHT variant and in the value of the VHT subfield.

The VHT subfield of the HT Control field indicates whether the HT Control Middle subfield is the VHT Variant or the HT Variant. The VHT subfield is set to 1 to indicate that the HT Control Middle subfield is the VHT Variant and is set to 0 to indicate that the HT Control Middle subfield is the HT Variant.

Source: [IEEE 802.11-2016 Standard](#) (Page 654)

60. The +HTC frame includes an LAC subfield, which allows the station to perform antenna selection. The LAC frame format includes the MAI subfield (MCS request or ASEL Indication). When MAI is set to “14,” the MFB/ASELC subfield (MCS Feedback/Antenna Selection Command) is used as the Antenna Selection Command. Also, the frame format of ASEL subfield contains ASEL Command and ASEL Data subfields.

61. As an example, when ASEL Command is “2,” it is interpreted as RXASSI signal (“including a receive antenna selection sounding indication (RXASSI) signal”), and the ASEL Data field contains the number of remaining sounding PPDU to be received (“a number N of the plural consecutive ZLF sounding packets”). NDP sounding can be indicated by the HT NDP announcement subfield (when set to 1) in the HT Control field.

**null data packet (NDP):** A physical layer (PHY) protocol data unit (PPDU) that carries no Data field.

Source: [IEEE 802.11-2016 Standard](#) (Page 157)

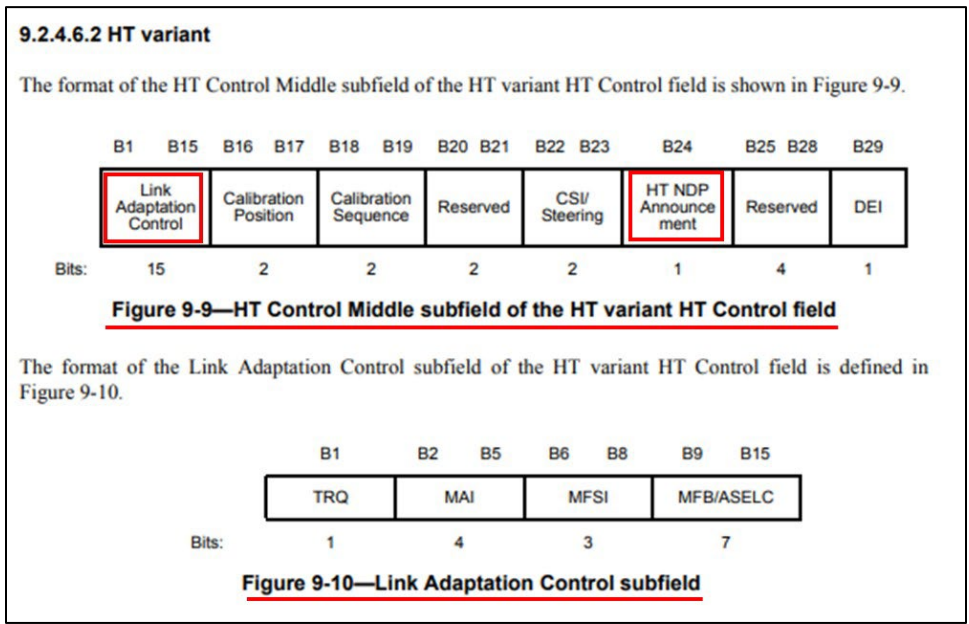

Source: [IEEE 802.11-2016 Standard](#) (Page 655)



**Table 9-12—Subfields of Link Adaptation Control subfield**

Subfield	Meaning	Definition
TRQ	Training request	Set to 1 to request the responder to transmit a sounding PPDU. Set to 0 to indicate that the responder is not requested to transmit a sounding PPDU. See 10.32.2 and 10.34.2.
MAI	MCS request (MRQ) or ASEL indication	Set to 14 (indicating ASEL1) to indicate that the MFB/ASELC subfield is interpreted as ASEL. Otherwise, the MAI subfield is interpreted as shown in Figure 9-11, and the MFB/ASELC subfield is interpreted as MCS feedback (MFB).
MFSI	MCS feedback sequence identifier	Set to the received value of MSI contained in the frame to which the MFB information refers. Set to 7 for unsolicited MFB.
MFB/ASELC	MCS feedback and antenna selection command/data	When the MAI subfield is equal to the value ASEL1, this subfield is interpreted as defined in Figure 9-12 and Table 9-14. Otherwise, this subfield contains recommended MFB. A value of 127 indicates that no feedback is present.

The structure of the MAI subfield of the Link Adaptation Control subfield is defined in Figure 9-11. The subfields of the MAI subfield are defined in Table 9-13.

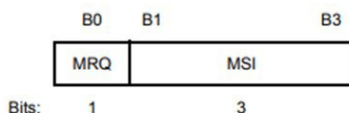
**Figure 9-11—MAI subfield**

Source: [IEEE 802.11-2016 Standard](#) (Page 656)

The ASELC subfield of the Link Adaptation Control subfield contains the ASEL Command and ASEL Data subfields, as shown in Figure 9-12. The encoding of these subfields is shown in Table 9-14.

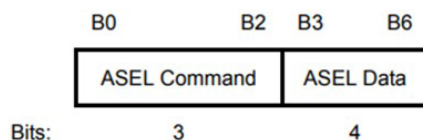
**Figure 9-12—ASELC subfield**

Source: [IEEE 802.11-2016 Standard](#) (Page 657)

**NOTE**—If the HT variant HT Control field is carried in a sounding PPDU, then the value of the ASEL Data field contains the remaining number of sounding frames following the current one. If null data packet (NDP) sounding frame is used, then the value in the ASEL Data field contains the number of NDPs following a non-NDP+HTC. The HT NDP Announcement subfield in the HT Control field is set to 1 to indicate NDP sounding.

Source: [IEEE 802.11-2016 Standard](#) (Page 657)

**Table 9-14—ASEL Command and ASEL Data subfields**

ASEL Command	Interpretation of ASEL Command	ASEL Data
0	Transmit Antenna Selection Sounding Indication (TXASSI)	Number of remaining sounding PPDU's to be transmitted 0 to 15  See NOTE
1	Transmit Antenna Selection Sounding Request (TXASSR) or Transmit ASEL Sounding Resumption	0 when the command is Transmit ASEL Sounding Request A number in the range 1 to 15, the number being the number of the first sounding PPDU to be transmitted when the command is Transmit ASEL Sounding Resumption, where 0 corresponds to the first sounding PPDU in the original ASEL training sequence
2	Receive Antenna Selection Sounding Indication (RXASSI)	Number of remaining sounding PPDU's to be received 0 to 15  See NOTE
3	Receive Antenna Selection Sounding Request (RXASSR)	Number of sounding PPDU's required 0 to 15
4	Sounding Label	Sequence number of the sounding PPDU corresponding to a channel state information (CSI) frame in ASEL feedback 0 to 15
5	No Feedback Due to ASEL Training Failure or Stale Feedback	A number in the range 0 to 15, the number being the number of the first sounding PPDU that was not received properly, where 0 corresponds to the first sounding PPDU in the ASEL training sequence, or 0 if no sounding PPDU's were received properly, or 0 if this is a request for a full retraining sequence
6	Transmit Antenna Selection Sounding Indication requesting feedback of explicit CSI (TXASSI-CSI)	Number of remaining sounding PPDU's to be transmitted 0 to 15  See NOTE
7	Reserved	Reserved

Source: [IEEE 802.11-2016 Standard](#) (Page 657)

62. TCL directly infringes the '686 Patent when, for example, it and/or its agents use the accused products, including during testing of the accused products. TCL also directly infringes the '686 Patent when the accused products are used after purchase by a customer or end user. For example, the accused products are built with hardware and/or software components that control the operation of the accused products. These components cause the accused products to perform the steps of the claimed invention after, for example, receiving sounding packets. TCL also directly infringes the '686 Patent by exercising direction or control over the use of the accused products by others, including its affiliates, its subsidiaries, its business

partners (including certification and testing organizations), and/or its customers and end-users. TCL contracts with, advises, and/or encourages such persons to engage in conduct satisfying one or more elements of the asserted claims, deriving a financial or other benefit (e.g., improved wireless communications) from doing so. TCL conditions these benefits on, for example, such persons performing certain activities involving the accused products during specified conditions that cause the accused products to perform the steps of the claimed method (e.g., after receiving sounding packets).

63. TCL has had knowledge of the '686 Patent at least as of the date when it was notified of the filing of this action.

64. Freedom Patents has been damaged as a result of the infringing conduct by TCL alleged above. Thus, TCL is liable to Freedom Patents in an amount that adequately compensates it for such infringements, which, by law, cannot be less than a reasonable royalty, together with interest and costs as fixed by this Court under 35 U.S.C. § 284.

65. Freedom Patents has neither made nor sold unmarked articles that practice the '686 Patent, and is entitled to collect pre-filing damages for the full period allowed by law for infringement of the '686 Patent.

## **COUNT II**

### **DIRECT INFRINGEMENT OF U.S. PATENT NO. 8,374,096**

66. On February 12, 2013, United States Patent No. 8,374,096 (“the '096 Patent”) was duly and legally issued by the United States Patent and Trademark Office for an invention entitled “Method for Selecting Antennas and Beams in MIMO Wireless LANs.”

67. Freedom Patents is the owner of the '096 Patent, with all substantive rights in and to that patent, including the sole and exclusive right to prosecute this action and enforce the '096 Patent against infringers, and to collect damages for all relevant times.

68. TCL used products and/or systems including, for example, its TCL 65S455 (with 2x2 MIMO) family of TVs, the Alcatel LINKZONE 4G LTE Cat4 Mobile Wi-Fi (with 2x2 MIMO),<sup>19</sup> and other products<sup>20</sup> that implement MIMO Wi-Fi capabilities (“accused products”):



<sup>19</sup> The Alcatel LINKZONE 4G LTE Cat4 Mobile Wi-Fi has the TCL model number MW41NF. *See, e.g.*, <https://deviceatlas.com/device-data/devices/alcatel/mw41nf/46919001>.

<sup>20</sup> *See, e.g.*, TCL Smart TV 3-Series (32S356, 32S327, 40S325, 43S325, 28S305, 32S305, 40S305, 43S305, 49S305, 32S301, 32S321), Smart TV 4-Series (43S45, 43S453, 50S453, 55S453, 65S453, 75S453, 43S451, 50S451, 55S451, 65S451, 75S451, 85S451, 43S455, 50S455, 55S455, 58S455, 65S455, 75S455, 85S455, 43S446, 50S446, 55S446, 65S446, 75S446, 85S446, 43S431, 50S431, 55S431, 65S431, 75S431, 85S431, 43S435, 50S435, 55S435, 65S435, 75S435, 85S435, 43S434, 50S434, 55S434, 65S434, 70S434, 75S434, 55S41, 65S41, 55S21, 43S405, 49S405, 55S405, 65S405, 55S401, 65S401, 43S403, 49S403, 55S403, 65S403, 50S45, 75S45, 70S430, 75S433), Smart TV 5-Series (43S515, 49S515, 55S515, 65S515, 43S517, 49S517, 55S517, 65S517, 50T555, 55T555, 65T555, 75T555, 50S555, 55S555, 65S555, 75S555, 50S546, 55S546, 65S546, 75S546, 50S535, 55S535, 65S535, 75S535, 55T551, 65T551, 55S531, 65S531), Smart TV 6-Series (55R655, 65R655, 75R655, 85R655, 55R646, 65R646, 75R646, 55R635, 65R635, 75R635, 55R613, 55R615, 65R615, 75R615, 65R648, 75R648), TCL Smartphone 30 Series (T776O1-2AWFUS11, T776O1-2BWFUS11, T781S, T767W), Smartphone 20 Series (T810S-2BLCUS11, T810S-2ALCUS11, T768S, T768O, T773O-2AAZUS11, T773O-2BAZUS11), Smartphone A Series (5004S), Smartphone 10 Series (T799B-2ALCUS11, T799B-2BLCUS11, T790S, T770B-2ALCUS11), TCL Tablets (9198S, 9048S, 9049L, 9050S), TCL Stylus 5G (T779W), TCL LinkZone 5G (MW513UW), etc.

MODEL 65S455

# TCL 65" CLASS 4-SERIES 4K UHD HDR LED SMART ROKU TV - 65S455

Suggested Price

**\$429.99**

★★★★★ 4.5 (45) Write a review

WHERE TO BUY

Source: [www.tcl.com/us/en/products/home-theater/4-series/65-class-4-series-4k-uhd-led-smart-roku-tv-65s455](http://www.tcl.com/us/en/products/home-theater/4-series/65-class-4-series-4k-uhd-led-smart-roku-tv-65s455)

Wireless Connection	802.11ac <u>2x2 Dual Band</u> (support 2.4GHz & 5GHz)
---------------------	---

Source: [www.tcl.com/us/en/products/home-theater/4-series/65-class-4-series-4k-uhd-led-smart-roku-tv-65s455](http://www.tcl.com/us/en/products/home-theater/4-series/65-class-4-series-4k-uhd-led-smart-roku-tv-65s455)

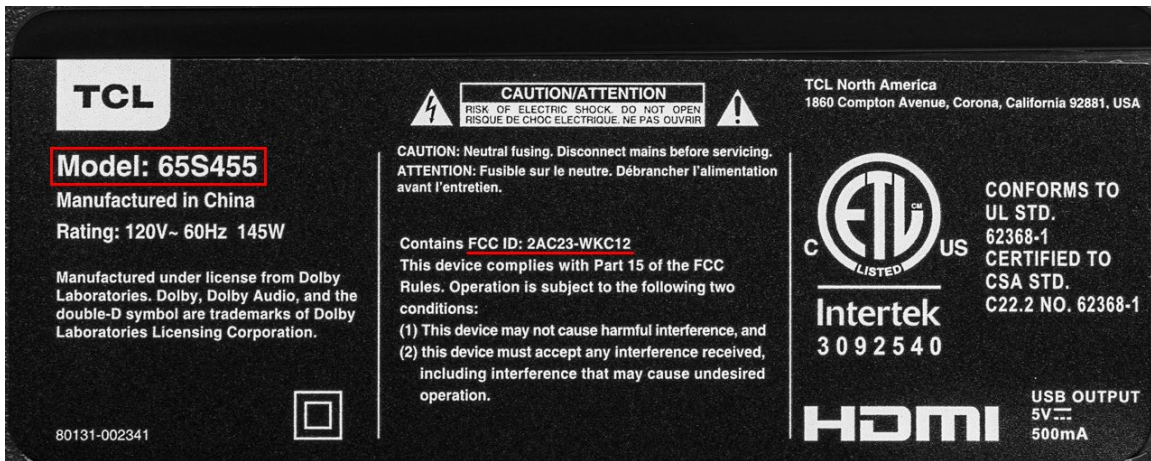

Source: [www.rtings.com/assets/products/gRVXk38E/tcl-4-series-s455-2022/label-large.jpg](http://www.rtings.com/assets/products/gRVXk38E/tcl-4-series-s455-2022/label-large.jpg)

## WIFI Module

### IEEE 802.11 a/b/g/n/ac 2T/2R

### Model Number: **WKC12R2501**

#### Product Description

The WKC12R2501 is a complete dual-band(2.4GHz and 5GHz)WIFI 2x2 MIMO module. This module provides a high level of integration with a dual-stream IEEE 802.11ac MAC/ base band /radio.The WLAN operation supports 20MHz,40MHz and 80MHz channels for data rates up to 866.7Mbps. It fully complies with IEEE 802.11 a/b/g/n/ac feature rich wireless connectivity at high standards,delivers reliable,cost-effective, throughput from an extended distance.

Source: <https://fccid.io/2AC23-WKC12/Users-Manual/User-manual-5654192>



**Source:** [www.alcatelmobile.com/product/mobile-broadband/mobile-wifi/linkzone-cat4-mobile-wi-fi](http://www.alcatelmobile.com/product/mobile-broadband/mobile-wifi/linkzone-cat4-mobile-wi-fi)

**ANTENNA**

LTE: 2X2 MIMO  
WCDMA: Internal  
GSM: Internal  
Wi-Fi: Internal 2X2

**Source:** [www.alcatelmobile.com/product/mobile-broadband/mobile-wifi/linkzone-cat4-mobile-wi-fi](http://www.alcatelmobile.com/product/mobile-broadband/mobile-wifi/linkzone-cat4-mobile-wi-fi)

69. By doing so, TCL has directly infringed (literally and/or under the doctrine of equivalents) at least Claim 1 of the '096 Patent. TCL's infringement in this regard is ongoing.

70. The TCL 65S455 Smart TV and the Alcatel LINKZONE 4G LTE Cat4 Mobile Wi-Fi are exemplary accused products.

71. TCL has infringed the '096 Patent by using the accused products and thereby practicing a method for selecting antennas in a multiple-input, multiple-output wireless local area network including a plurality of stations, each station includes a set of antennas.

72. For example, the TCL 65S455 Smart TV and the Alcatel LINKZONE 4G LTE Cat4 Mobile Wi-Fi communicate with other stations using the IEEE 802.11 protocol and include a set of antennas that are used for both transmitting and receiving data to and from the other

stations over a WLAN. The transmission and reception of data using multiple antennas simultaneously is known as MIMO (“multiple-input, multiple-output”). The stations communicating using MIMO implement antenna selection by initially transmitting or receiving sounding packets with each other to estimate the channel characteristics between them. The sounding packets correspond to a set of antennas that are available from a larger number of antennas.

## **Part 11: Wireless LAN Medium Access Control (MAC) and Physical Layer (PHY) Specifications**

### **1. Overview**

#### **1.1 Scope**

The scope of this standard is to define one medium access control (MAC) and several physical layer (PHY) specifications for wireless connectivity for fixed, portable, and moving stations (STAs) within a local area.

Source: [IEEE 802.11-2016 Standard](#) (Page 122)

An HT STA has PHY features consisting of the modulation and coding scheme (MCS) set described in 19.3.5 and physical layer (PHY) protocol data unit (PPDU) formats described in 19.1.4. Some PHY features that distinguish an HT STA from a non-HT STA are referred to as *multiple input, multiple output (MIMO) operation*; spatial multiplexing (SM); spatial mapping (including transmit beamforming); space-time block coding (STBC); low-density parity check (LDPC) encoding; and antenna selection (ASEL). The allowed PPDU formats are non-HT format, HT-mixed format, and HT-greenfield format (see 19.1.4). The PPDUs can be transmitted with 20 MHz bandwidth and might be transmitted with 40 MHz bandwidth.

Source: [IEEE 802.11-2016 Standard](#) (Page 197)

**multiple input, multiple output (MIMO):** A physical layer (PHY) configuration in which both transmitter and receiver use multiple antennas.

Source: [IEEE 802.11-2016 Standard](#) (Page 136)

**multi-user multiple input, multiple output (MU-MIMO):** A technique by which multiple stations (STAs), each with one or more antennas, either simultaneously transmit to a single STA or simultaneously receive from a single STA independent data streams over the same radio frequencies.

NOTE—IEEE Std 802.11 supports only downlink (DL) MU-MIMO. See **downlink multi-user multiple input, multiple output (DL-MU-MIMO)** (in 3.2).

Source: [IEEE 802.11-2016 Standard](#) (Page 136)

### 10.31 Link adaptation

#### 10.31.1 Introduction

To fully exploit MIMO channel variations and transmit beamforming on a MIMO link, a STA can request that another STA provide MIMO channel sounding and MFB.

Source: [IEEE 802.11-2016 Standard](#) (Page 1463)

### 10.30 Sounding PPDUs

The behavior described in this subclause is specific to the use of the HT variant HT Control field.

A sounding PPDU is a PPDU for which the SOUNDING parameter of the corresponding RXVECTOR or TXVECTOR has the value SOUNDING. Sounding PPDUs are transmitted by STAs to enable the receiving STAs to estimate the channel between the transmitting STA and the receiving STA.

A STA transmits sounding PPDUs when it operates in the following roles:

- MFB requester (see 10.31.2)
- HT beamformee responding to a training request, calibration initiator, or responder involved in implicit transmit beamforming (see 10.32.2.2, 10.32.2.3, and 10.32.2.4)
- HT beamformer involved in explicit transmit beamforming (see 10.32.3)
- ASEL transmitter and ASEL sounding-capable transmitter involved in ASEL (see 10.33.2)

A STA receives sounding PPDUs when it operates in the following roles:

- MFB responder (see 10.31.2)
- HT beamformer sending a training request, calibration initiator, or responder involved in implicit transmit beamforming (see 10.32.2.2, 10.32.2.3, and 10.32.2.4)
- HT beamformee involved in explicit transmit beamforming (see 10.32.3)
- Transmit ASEL responder and ASEL receiver involved in ASEL (see 10.33.2)

Source: [IEEE 802.11-2016 Standard](#) (Pages 1462-63)



### 10.33 Antenna selection (ASEL)

#### 10.33.1 Introduction

The procedures in this subclause apply only to HT and non-HT PPDU for which the HT Control field, if present, is the HT variant HT Control field.

ASEL is a time-variant mapping of the signals at the RF chains onto a set of antenna elements when the number of RF chains is smaller than the number of antenna elements. The mapping might be chosen based on instantaneous or averaged CSI. ASEL requires the training of the full size channel associated with all antenna elements, which is obtained by transmitting or receiving sounding PPDU over all antennas. These sounding PPDU should be sent within a single TXOP. To avoid channel distortions, these sounding PPDU shall be transmitted consecutively. The training information is exchanged using the HT Control field. When both transmitter and receiver have ASEL capabilities, training of transmit and receive antennas might be done one after another. ASEL supports up to eight antennas and up to four RF chains.

Source: [IEEE 802.11-2016 Standard](#) (Page 1481)

73. The method practiced using the accused products includes the step of receiving multiple transmitted sounding packets in a station, each sounding packet corresponding to a different subset of the set of antennas.

74. For example, during the antenna selection process, the stations receive multiple consecutive sounding PPDU (“receiving multiple transmitted sounding packets”). Each sounding PPDU corresponds to a different set of antennas from the available antennas (“a different subset of the set of antennas”). The first PPDU frame received is a +HTC frame followed by consecutive NDP (Null Data Packet) frames.

### 10.30 Sounding PPDU

The behavior described in this subclause is specific to the use of the HT variant HT Control field.

A sounding PPDU is a PPDU for which the SOUNDING parameter of the corresponding RXVECTOR or TXVECTOR has the value SOUNDING. Sounding PPDUs are transmitted by STAs to enable the receiving STAs to estimate the channel between the transmitting STA and the receiving STA.

A STA transmits sounding PPDU when it operates in the following roles:

- MFB requester (see 10.31.2)
- HT beamformee responding to a training request, calibration initiator, or responder involved in implicit transmit beamforming (see 10.32.2.2, 10.32.2.3, and 10.32.2.4)
- HT beamformer involved in explicit transmit beamforming (see 10.32.3)
- ASEL transmitter and ASEL sounding-capable transmitter involved in ASEL (see 10.33.2)

A STA receives sounding PPDU when it operates in the following roles:

- MFB responder (see 10.31.2)
- HT beamformer sending a training request, calibration initiator, or responder involved in implicit transmit beamforming (see 10.32.2.2, 10.32.2.3, and 10.32.2.4)
- HT beamformee involved in explicit transmit beamforming (see 10.32.3)
- Transmit ASEL responder and ASEL receiver involved in ASEL (see 10.33.2)

Source: [IEEE 802.11-2016 Standard](#) (Pages 1462-63)

### 10.33 Antenna selection (ASEL)

#### 10.33.1 Introduction

The procedures in this subclause apply only to HT and non-HT PPDU for which the HT Control field, if present, is the HT variant HT Control field.

ASEL is a time-variant mapping of the signals at the RF chains onto a set of antenna elements when the number of RF chains is smaller than the number of antenna elements. The mapping might be chosen based on instantaneous or averaged CSI. ASEL requires the training of the full size channel associated with all antenna elements, which is obtained by transmitting or receiving sounding PPDU over all antennas. These sounding PPDU should be sent within a single TXOP. To avoid channel distortions, these sounding PPDU shall be transmitted consecutively. The training information is exchanged using the HT Control field. When both transmitter and receiver have ASEL capabilities, training of transmit and receive antennas might be done one after another. ASEL supports up to eight antennas and up to four RF chains.

Source: [IEEE 802.11-2016 Standard](#) (Page 1481)

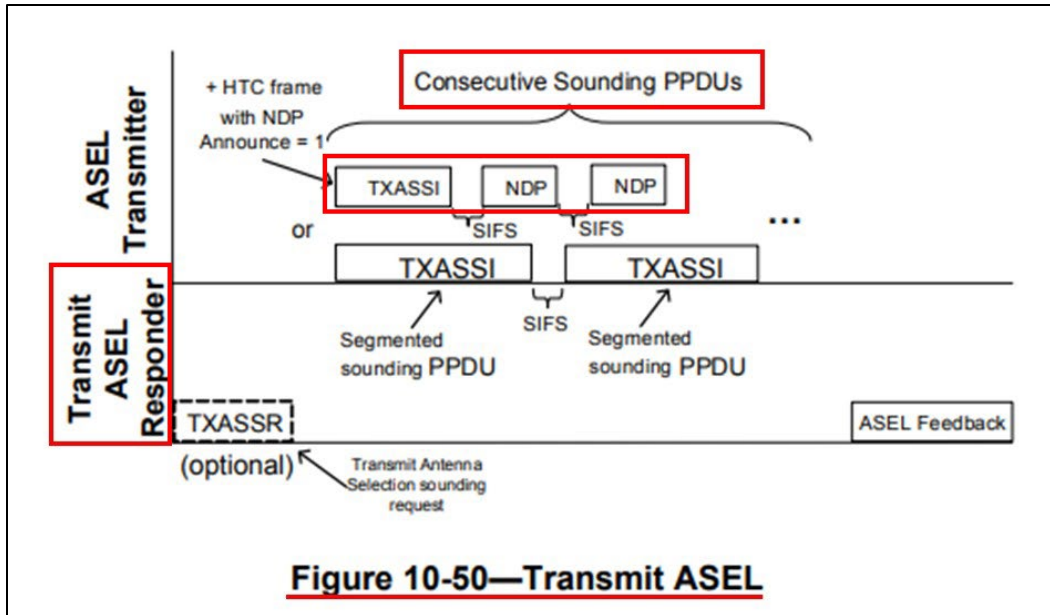

Source: [IEEE 802.11-2016 Standard](#) (Page 1483)

**physical layer (PHY) frame:** The unit of data exchanged between PHY entities. *Syn:* **physical layer (PHY) protocol data unit (PPDU).**

NOTE—In contexts in which the PHY is clearly the subject, “frame” is an implicit reference to a PHY frame.

**physical layer (PHY) protocol data unit (PPDU):** The unit of data exchanged between two peer PHY entities to provide the PHY data service.

Source: [IEEE 802.11-2016 Standard](#) (Page 138)

75. The method practiced using the accused products includes the step of estimating, in the station, a channel matrix for each subset of antennas.

76. For example, the transmit ASEL responder station receives the sounding PPDU. The transmit ASEL responder station then estimates the channel state information based on the measurements from the received sounding PPDU, each of which corresponds to a different set of antennas (“for each subset of antennas”). After the estimate is complete, a Channel State Information report (CSI report) is generated and sent to the ASEL transmitter station. The CSI report is part of the CSI frame format and is included as a CSI report field, which includes a Channel Matrix subfield.

### 10.30 Sounding PPDU

The behavior described in this subclause is specific to the use of the HT variant HT Control field.

A sounding PPDU is a PPDU for which the SOUNDING parameter of the corresponding RXVECTOR or TXVECTOR has the value SOUNDING. Sounding PPDUs are transmitted by STAs to enable the receiving STAs to estimate the channel between the transmitting STA and the receiving STA.

A STA transmits sounding PPDU when it operates in the following roles:

- MFB requester (see 10.31.2)
- HT beamformee responding to a training request, calibration initiator, or responder involved in implicit transmit beamforming (see 10.32.2.2, 10.32.2.3, and 10.32.2.4)
- HT beamformer involved in explicit transmit beamforming (see 10.32.3)
- ASEL transmitter and ASEL sounding-capable transmitter involved in ASEL (see 10.33.2)

A STA receives sounding PPDUs when it operates in the following roles:

- MFB responder (see 10.31.2)
- HT beamformer sending a training request, calibration initiator, or responder involved in implicit transmit beamforming (see 10.32.2.2, 10.32.2.3, and 10.32.2.4)
- HT beamformee involved in explicit transmit beamforming (see 10.32.3)
- Transmit ASEL responder and ASEL receiver involved in ASEL (see 10.33.2)

Source: [IEEE 802.11-2016 Standard](#) (Pages 1462-63)

#### 19.3.13.3 Sounding PPDU for calibration

In the case of a bidirectional calibration exchange, two STAs exchange sounding PPDUs, the exchange of which enables the receiving STA to compute an estimate of the MIMO channel matrix  $H_k$  for each subcarrier  $k$ . In general, in an exchange of calibration messages, the number of spatial streams is less than the number of transmit antennas. In such cases, HT-ELTFs are used. In the case of sounding PPDU for calibration, the antenna mapping matrix shall be as shown in Equation (19-86).

$$Q_k = C_{CSD}(k)P_{CAL} \quad (19-86)$$

Source: [IEEE 802.11-2016 Standard](#) (Page 2401)

- c) The transmit ASEL responder estimates the subchannel corresponding to each sounding PPDU.
- d) If the ASEL Command subfield in the sounding frames is equal to TXASSI-CSI, after receiving all of the sounding PPDU, the transmit ASEL responder shall respond with the full size CSI in a subsequent TXOP. If the ASEL Command subfield in the sounding frames is equal to TXASSI, after receiving all of the sounding PPDU, the transmit ASEL responder may either respond with the full size CSI in a subsequent TXOP, or conduct ASEL computation and provide the selected antenna indices in a subsequent TXOP.
- 1) CSI is transported using the MIMO CSI Matrices frame defined in 9.6.12.6 contained within either an Action No Ack or Action frame. Multiple CSI frames may be required to provide the complete feedback, in which case the value of the Sounding Timestamp field within each of

Source: [IEEE 802.11-2016 Standard](#) (Page 1482)

When the MIMO channel measurements become available at STA B, STA B shall send one or more CSI frames that contain the CSI report (Step 2 in Figure 10-47). This CSI report shall have full precision, i.e.,  $N_g=1$  (no grouping) and  $N_b=3$  (8 bits). In these CSI frames, the Calibration Sequence subfields in HT Control fields shall be set to the same value that is indicated in the Calibration Sounding Complete frame. These CSI frames shall have a frame type of Management Action +HTC.

Source: [IEEE 802.11-2016 Standard](#) (Page 1477)

#### **9.6.12.6 CSI frame format**

The CSI frame is an Action or an Action No Ack frame of category HT. The format of its Action field is defined in Table 9-338.

**Table 9-338—CSI frame Action field format**

Order	Information
1	Category
2	HT Action
3	MIMO Control (see 9.4.1.27)
4	<u>CSI Report</u> (see 9.4.1.28)

Source: [IEEE 802.11-2016 Standard](#) (Page 1214)

**9.4.1.28 CSI Report field**

The CSI Report field is used by the CSI frame (see 9.6.12.6) to carry explicit channel state information to a transmit HT beamformer, as described in 10.32.3.

The CSI Matrix subfields in the CSI Report field shown in Table 9-52 and Table 9-53 are matrices whose elements are taken from the CHAN\_MAT parameter of RXVECTOR (see Table 19-1).

**Table 9-52—CSI Report field (20 MHz)**

Field	Size (bits)	Meaning
SNR in receive chain 1	8	Signal-to-noise ratio in the first receive chain of the STA sending the report.
...		
SNR in receive chain $N_r$	8	Signal-to-noise ratio in the $N_r$ 'th receive chain of the STA sending the report.
CSI Matrix for carrier $-28$	$3+2 \times N_b \times N_c \times N_r$	CSI matrix (see Figure 9-95)
...		

Source: [IEEE 802.11-2016 Standard](#) (Page 746)

Parameter	Condition	Value	TXVECTOR	RXVECTOR
			See NOTE 1	
CHAN_MAT	CHAN_MAT_TYPE is COMPRESSED_SV	Contains a set of compressed beamforming feedback matrices as defined in 19.3.12.3.6 based on the channel measured during the training symbols of the received PPDU. The number of elements depends on the number of spatial streams and the number of transmit chains.	N	Y
	CHAN_MAT_TYPE is NON_COMPRESSED_SV	Contains a set of noncompressed beamforming feedback matrices as defined in 19.3.12.3.5 based on the channel measured during the training symbols of the received PPDU. The number of complex elements is $N_{ST} \times N_r \times N_c$ where $N_{ST}$ is the total number of subcarriers, $N_c$ is the number of columns, and $N_r$ is the number of rows in each matrix.	N	Y
	CHAN_MAT_TYPE is CSI_MATRICES	Contains a set of CSI matrices as defined in 19.3.12.3.2 based on the channel measured during the training symbols of the received PPDU. The number of complex elements is $N_{ST} \times N_r \times N_c$ where $N_{ST}$ is the total number of subcarriers, $N_c$ is the number of columns, and $N_r$ is the number of rows in each matrix.	N	Y
	Otherwise	Not present	N	N
CHAN_MAT_TYPE	FORMAT is HT_MF or HT_GF	Enumerated type: COMPRESSED_SV indicates that CHAN_MAT is a set of compressed beamforming vector matrices. NON_COMPRESSED_SV indicates that CHAN_MAT is a set of noncompressed beamforming vector matrices. <u>CSI_MATRICES indicates that CHAN_MAT is a set of channel state matrices.</u>	N	Y
	Otherwise	Not present	N	N

Source: [IEEE 802.11-2016 Standard](#) (Pages 2340-41)

77. The method practiced using the accused products includes the step of sending, by the station, a frame including a high throughput (HT) control field to initiate a selecting of antennas after estimating the channel matrix for each subset of antennas, such that a subset of the antennas is selected according to the channel matrices.

78. For example, the transmit ASEL responder station, after receiving the consecutive sounding packets, estimates the Channel State Information along with the Channel Matrix for each channel. Based on the estimated channel matrices, the set of antennas to be used for MIMO communication is selected (“a subset of the antennas is selected according to the channel matrices”).

79. After estimating the channel matrices, the transmit ASEL responder station sends (“sending, by the station”) the HT category CSI Frame or the HT category Antenna Selection Indices Feedback frame (“a frame including a high throughput (HT) control field”) back to the ASEL transmitter.

80. The CSI Frame includes the CSI Report, which can be utilized by the ASEL transmitter to compute and select the antenna. The Antenna Selection Indices Feedback frame includes the Antenna Indices feedback. Each bit of the Antenna Indices feedback corresponds to an antenna and indicates its selection by the ASEL responder.

### 10.33 Antenna selection (ASEL)

#### 10.33.1 Introduction

The procedures in this subclause apply only to HT and non-HT PPDU for which the HT Control field, if present, is the HT variant HT Control field.

ASEL is a time-variant mapping of the signals at the RF chains onto a set of antenna elements when the number of RF chains is smaller than the number of antenna elements. The mapping might be chosen based on instantaneous or averaged CSI. ASEL requires the training of the full size channel associated with all antenna elements, which is obtained by transmitting or receiving sounding PPDU over all antennas. These sounding PPDU should be sent within a single TXOP. To avoid channel distortions, these sounding PPDU shall be transmitted consecutively. The training information is exchanged using the HT Control field. When both transmitter and receiver have ASEL capabilities, training of transmit and receive antennas might be done one after another. ASEL supports up to eight antennas and up to four RF chains.

Source: [IEEE 802.11-2016 Standard](#) (Page 1481)

The frame exchange sequence for transmit ASEL is shown in Figure 10-50, where the term *ASEL transmitter* identifies the STA that is conducting transmit ASEL, and the term *transmit ASEL responder* identifies the STA that provides ASEL feedback. The frame exchange comprises the following steps:

Source: [IEEE 802.11-2016 Standard](#) (Page 1482)



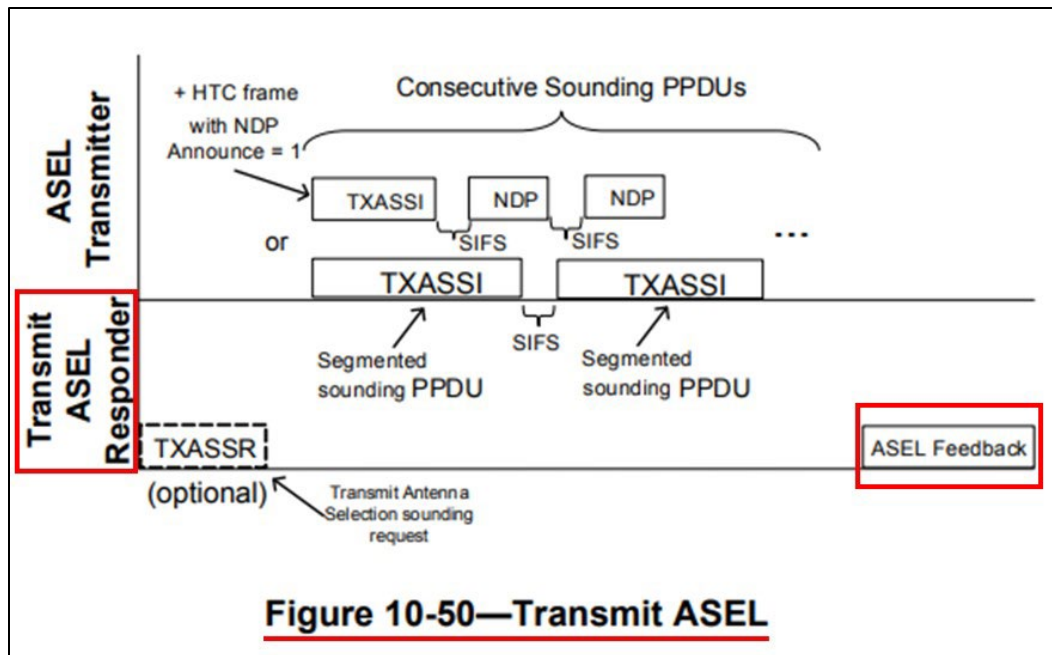

Source: [IEEE 802.11-2016 Standard](#) (Page 1483)

81. ASEL feedback is provided either by sending a CSI frame that contains the CSI report or an Antenna Selection Indices Feedback frame that contains the selected antenna indices by the ASEL responder.

- c) The transmit ASEL responder estimates the subchannel corresponding to each sounding PPDU.
- d) If the ASEL Command subfield in the sounding frames is equal to TXASSI-CSI, after receiving all of the sounding PPDU's, the transmit ASEL responder shall respond with the full size CSI in a subsequent TXOP. If the ASEL Command subfield in the sounding frames is equal to TXASSI, after receiving all of the sounding PPDU's, the transmit ASEL responder may either respond with the full size CSI in a subsequent TXOP, or conduct ASEL computation and provide the selected antenna indices in a subsequent TXOP.
  - 1) CSI is transported using the MIMO CSI Matrices frame defined in 9.6.12.6 contained within either an Action No Ack or Action frame. Multiple CSI frames may be required to provide the complete feedback, in which case the value of the Sounding Timestamp field within each of

Source: [IEEE 802.11-2016 Standard](#) (Page 1482)

- 1) CSI is transported using the MIMO CSI Matrices frame defined in 9.6.12.6 contained within either an Action No Ack or Action frame. Multiple CSI frames may be required to provide the complete feedback, in which case the value of the Sounding Timestamp field within each of these CSI frames shall correspond to the arrival time of the sounding frame that was used to generate the feedback information contained in the frame.
- 2) Antenna indices feedback is carried in the Antenna Selection Indices Feedback frame, defined in 9.6.12.9. One octet of the Antenna Selection Indices field is used to carry the selected antenna indices feedback.

Source: [IEEE 802.11-2016 Standard](#) (Pages 1482-83)

#### **9.6.12.6 CSI frame format**

The CSI frame is an Action or an Action No Ack frame of category HT. The format of its Action field is defined in Table 9-338.

**Table 9-338—CSI frame Action field format**

Order	Information
1	Category
2	HT Action
3	MIMO Control (see 9.4.1.27)
4	<u>CSI Report</u> (see 9.4.1.28)

Source: [IEEE 802.11-2016 Standard](#) (Page 1214)

#### **9.6.12.6 CSI frame format**

The CSI frame is an Action or an Action No Ack frame of category HT. The format of its Action field is defined in Table 9-338.

**Table 9-338—CSI frame Action field format**

Order	Information
1	Category
2	HT Action
3	MIMO Control (see 9.4.1.27)
4	<u>CSI Report</u> (see 9.4.1.28)

Source: [IEEE 802.11-2016 Standard](#) (Page 1214)

**9.6.12.9 Antenna Selection Indices Feedback frame format**

The Antenna Selection Indices Feedback frame is an Action or Action No Ack frame of category HT. The format of its Action field is defined in Table 9-341.

**Table 9-341—Antenna Selection Indices Feedback frame Action field format**

Order	Information
1	Category
2	HT Action
3	Antenna Selection Indices (see 9.4.1.31)

The Category field is defined in 9.4.1.11.

The HT Action field is defined in 9.6.12.1.

Source: [IEEE 802.11-2016 Standard](#) (Page 1216)

**9.6.12.1 HT Action field**

Several Action frame formats are defined to support HT features. An HT Action field, in the octet immediately after the Category field, differentiates the HT Action frame formats. The HT Action field values associated with each frame format within the HT category are defined in Table 9-333. The frame formats are defined in 9.6.12.2 to 9.6.12.9.

**Table 9-333—HT Action field values**

HT Action field value	Meaning	Time priority
0	Notify Channel Width	No
1	SM Power Save	No
2	PSMP	Yes
3	Set PCO Phase	Yes
4	CSI	Yes
5	Noncompressed Beamforming	Yes
6	Compressed Beamforming	Yes
7	ASEL Indices Feedback	Yes
8–255	Reserved	—

Source: [IEEE 802.11-2016 Standard](#) (Page 1212)

**9.4.1.28 CSI Report field**

The CSI Report field is used by the CSI frame (see 9.6.12.6) to carry explicit channel state information to a transmit HT beamformer, as described in 10.32.3.

The CSI Matrix subfields in the CSI Report field shown in Table 9-52 and Table 9-53 are matrices whose elements are taken from the CHAN\_MAT parameter of RXVECTOR (see Table 19-1).

Source: [IEEE 802.11-2016 Standard](#) (Page 1214)

**Table 19-1—TXVECTOR and RXVECTOR parameters**

Parameter	Condition	Value	TXVECTOR	RXVECTOR
			See NOTE 1	
CHAN_MAT	CHAN_MAT_TYPE is COMPRESSED_SV	Contains a set of compressed beamforming feedback matrices as defined in 19.3.12.3.6 based on the channel measured during the training symbols of the received PPDU. The number of elements depends on the number of spatial streams and the number of transmit chains.	N	Y
	CHAN_MAT_TYPE is NON_COMPRESSED_SV	Contains a set of noncompressed beamforming feedback matrices as defined in 19.3.12.3.5 based on the channel measured during the training symbols of the received PPDU. The number of complex elements is $N_{ST} \times N_r \times N_c$ where $N_{ST}$ is the total number of subcarriers, $N_c$ is the number of columns, and $N_r$ is the number of rows in each matrix.	N	Y
	<b>CHAN_MAT_TYPE is CSI_MATRICES</b>	<u>Contains a set of CSI matrices as defined in 19.3.12.3.2 based on the channel measured during the training symbols of the received PPDU.</u> The number of complex elements is $N_{ST} \times N_r \times N_c$ where $N_{ST}$ is the total number of subcarriers, $N_c$ is the number of columns, and $N_r$ is the number of rows in each matrix.	N	Y
	Otherwise	Not present	N	N
CHAN_MAT_TYPE	FORMAT is HT_MF or HT_GF	Enumerated type: COMPRESSED_SV indicates that CHAN_MAT is a set of compressed beamforming vector matrices. NON_COMPRESSED_SV indicates that CHAN_MAT is a set of noncompressed beamforming vector matrices. <u>CSI_MATRICES indicates that CHAN_MAT is a set of channel state matrices.</u>	N	Y
	Otherwise	Not present	N	N

Source: [IEEE 802.11-2016 Standard](#) (Pages 2340-41)

**9.4.1.31 Antenna Selection Indices field**

The Antenna Selection Indices field is used within the Antenna Selection Indices Feedback frame to carry ASEL feedback, as described in 10.33.

The Antenna Selection Indices field is 1 octet in length and illustrated in Figure 9-99.



**Figure 9-99—Antenna Selection Indices fixed field**

Bits 0 to 7 in the Antenna Selection Indices field correspond to antennas with indices 0 to 7, respectively. A value of 1 in a bit indicates the corresponding antenna is selected, and the value of 0 indicates the corresponding antenna is not selected.

Source: [IEEE 802.11-2016 Standard](#) (Page 753)

**Antenna Selection.** There are  $M$  columns and  $N$  rows in the CSI matrix  $\mathbf{H}$ ; each corresponds to one transmit or receive antenna. To compute the Effective CSI that would be used under a particular antenna selection, we simply pick the subset of rows and columns that correspond to the desired antennas. Note that this includes both transmit antenna selection (e.g., when  $S < M$ , pick the best  $S$  of the  $M$  transmit antennas to send with) and receive antenna selection (e.g., when  $N > S$ , turn off the least useful of the excess antennas in order to reduce power consumption).

Source: <https://arxiv.org/ftp/arxiv/papers/1301/1301.6644.pdf> (Page 76)

82. In the method practiced using the accused products, the HT control field includes a MCS selection feedback (MFB) field, and if an ASI field is set to “1” or if an MRS field is set to “111”, then the MFB field is used for antenna selection, beam selection, or as a transmitter beam forming control (ASBFC) field, in which ASBFC field includes a command subfield and a data subfield, and in which the data subfield indicates a number of the multiple sounding packets.

83. For example, the ASEL feedback is a +HTC frame that includes an LAC subfield, which allows the station to perform antenna selection. The LAC frame format includes the MAI (MCS request or ASEL Indication) subfield. When MAI is set to “14,” the MFB/ASELC (MCS

Feedback/Antenna Selection Command) subfield (“MFB field”) is used as the Antenna Selection Command. Also, the frame format of ASELC subfield (“ASBFC field”) contains ASEL Command and ASEL Data subfields (“includes a command subfield and a data subfield”). The ASEL Data field (“data subfield”) contains information about the number of sounding PPDU (“indicates a number of the multiple sounding packets”).

### 10.33 Antenna selection (ASEL)

#### 10.33.1 Introduction

The procedures in this subclause apply only to HT and non-HT PPDU for which the HT Control field, if present, is the HT variant HT Control field.

ASEL is a time-variant mapping of the signals at the RF chains onto a set of antenna elements when the number of RF chains is smaller than the number of antenna elements. The mapping might be chosen based on instantaneous or averaged CSI. ASEL requires the training of the full size channel associated with all antenna elements, which is obtained by transmitting or receiving sounding PPDU over all antennas. These sounding PPDU should be sent within a single TXOP. To avoid channel distortions, these sounding PPDU shall be transmitted consecutively. The training information is exchanged using the HT Control field. When both transmitter and receiver have ASEL capabilities, training of transmit and receive antennas might be done one after another. ASEL supports up to eight antennas and up to four RF chains.

Source: [IEEE 802.11-2016 Standard](#) (Page 1481)

A frame that contains the HT Control field is referred to as a +HTC frame. A Control Wrapper frame is a +HTC frame.

Source: [IEEE 802.11-2016 Standard](#) (Page 637)

**9.2.3 General frame format**

The MAC frame format comprises a set of fields that occur in a fixed order in all frames. Figure 9-1 depicts the general MAC frame format. The first three fields (Frame Control, Duration/ID, and Address 1) and the last field (FCS) in Figure 9-1 constitute the minimal frame format and are present in all frames, including reserved types and subtypes. The fields Address 2, Address 3, Sequence Control, Address 4, QoS Control, HT Control, and Frame Body are present only in certain frame types and subtypes. Each field is defined in 9.2.4. The format of each of the individual subtypes of each frame type is defined in 9.3. The components of management frame bodies are defined in 9.4. The formats of Action frames are defined in 9.6.

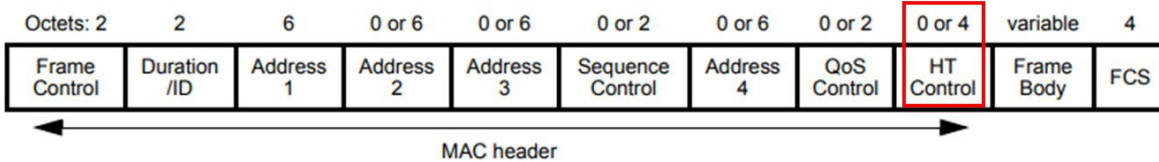

**Figure 9-1—MAC frame format**

Source: [IEEE 802.11-2016 Standard](#) (Pages 637-38)

**9.2.4.6 HT Control field**

**9.2.4.6.1 General**

The HT Control field is always present in a Control Wrapper frame and is present in QoS Data and Management frames as determined by the +HTC/Order subfield of the Frame Control field as defined in 9.2.4.1.10.

NOTE—The only control frame subtype for which HT Control field is present is the Control Wrapper frame. A Control frame that is described as +HTC (e.g., an RTS+HTC, CTS+HTC, BlockAck+HTC or BlockAckReq+HTC frame) implies the use of the Control Wrapper frame to carry that Control frame.

The format of the 4-octet HT Control field is shown in Figure 9-8.

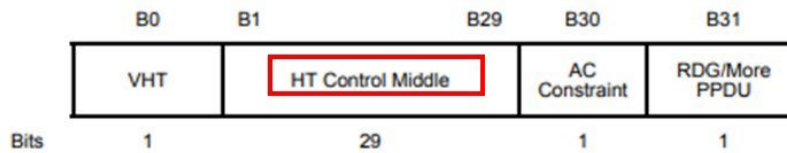
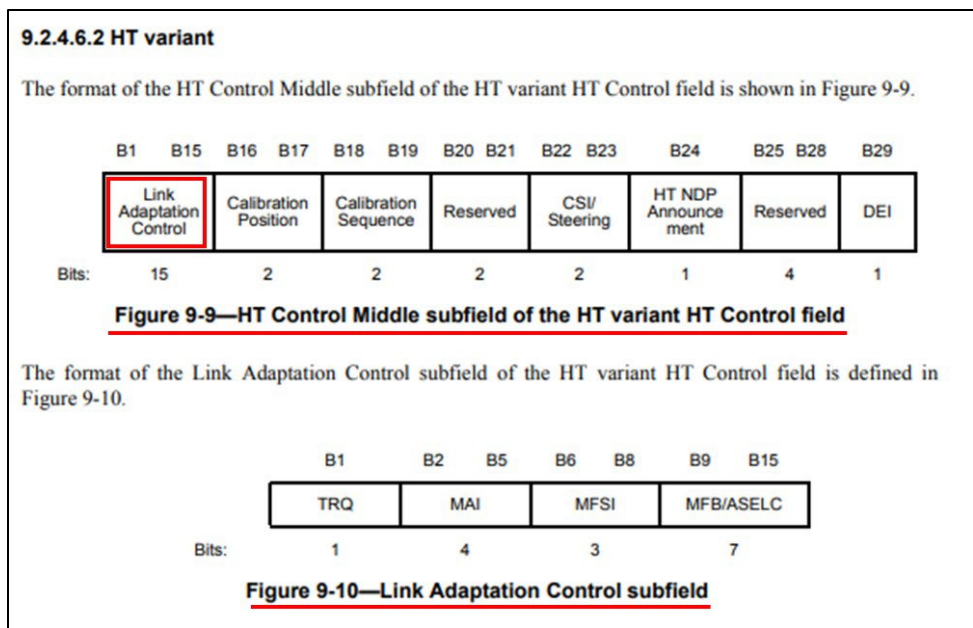

**Figure 9-8—HT Control field**

The HT Control field has two forms, the HT variant and the VHT variant. The two forms differ in the format of the HT Control Middle subfield, described in 9.2.4.6.2 for the HT variant and in 9.2.4.6.3 for the VHT variant and in the value of the VHT subfield.

The VHT subfield of the HT Control field indicates whether the HT Control Middle subfield is the VHT Variant or the HT Variant. The VHT subfield is set to 1 to indicate that the HT Control Middle subfield is the VHT Variant and is set to 0 to indicate that the HT Control Middle subfield is the HT Variant.

Source: [IEEE 802.11-2016 Standard](#) (Page 654)



Source: [IEEE 802.11-2016 Standard](#) (Page 655)

**Table 9-12—Subfields of Link Adaptation Control subfield**

Subfield	Meaning	Definition
TRQ	Training request	Set to 1 to request the responder to transmit a sounding PPDU. Set to 0 to indicate that the responder is not requested to transmit a sounding PPDU. See 10.32.2 and 10.34.2.
MAI	MCS request (MRQ) or ASEL indication	Set to 14 (indicating ASEL) to indicate that the MFB/ASEL subfield is interpreted as ASEL. Otherwise, the MAI subfield is interpreted as shown in Figure 9-11, and the MFB/ASEL subfield is interpreted as MCS feedback (MFB).
MFSI	MCS feedback sequence identifier	Set to the received value of MSI contained in the frame to which the MFB information refers. Set to 7 for unsolicited MFB.
MFB/ASEL	MCS feedback and antenna selection command/data	When the MAI subfield is equal to the value ASEL, this subfield is interpreted as defined in Figure 9-12 and Table 9-14. Otherwise, this subfield contains recommended MFB. A value of 127 indicates that no feedback is present.

The structure of the MAI subfield of the Link Adaptation Control subfield is defined in Figure 9-11. The subfields of the MAI subfield are defined in Table 9-13.

B0
B1
B3

MRQ	MSI
Bits:	1

**Figure 9-11—MAI subfield**

Source: [IEEE 802.11-2016 Standard](#) (Page 656)



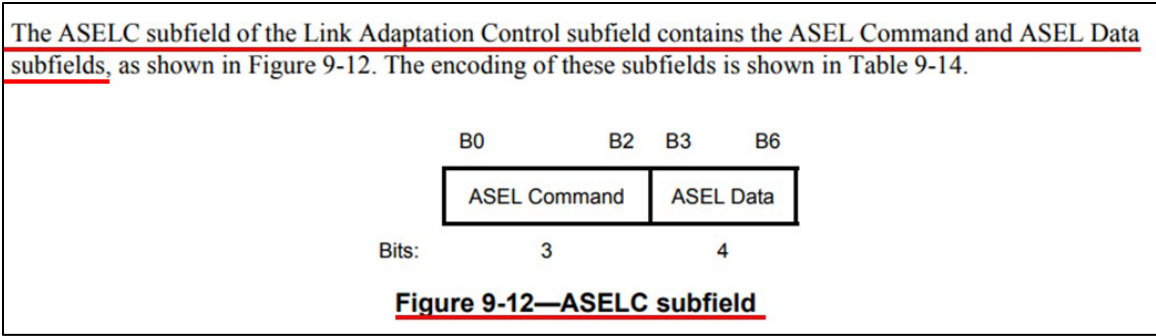

Source: [IEEE 802.11-2016 Standard](#) (Page 657)

**Table 9-14—ASEL Command and ASEL Data subfields**

ASEL Command	Interpretation of ASEL Command	ASEL Data
0	Transmit Antenna Selection Sounding Indication (TXASSI)	Number of remaining sounding PPDU's to be transmitted 0 to 15
		See NOTE
1	Transmit Antenna Selection Sounding Request (TXASSR) or Transmit ASEL Sounding Resumption	0 when the command is Transmit ASEL Sounding Request A number in the range 1 to 15, the number being the number of the first sounding PPDU to be transmitted when the command is Transmit ASEL Sounding Resumption, where 0 corresponds to the first sounding PPDU in the original ASEL training sequence
2	Receive Antenna Selection Sounding Indication (RXASSI)	Number of remaining sounding PPDU's to be received 0 to 15
		See NOTE
3	Receive Antenna Selection Sounding Request (RXASSR)	Number of sounding PPDU's required 0 to 15
4	Sounding Label	Sequence number of the sounding PPDU corresponding to a channel state information (CSI) frame in ASEL feedback 0 to 15
5	No Feedback Due to ASEL Training Failure or Stale Feedback	A number in the range 0 to 15, the number being the number of the first sounding PPDU that was not received properly, where 0 corresponds to the first sounding PPDU in the ASEL training sequence, or 0 if no sounding PPDU's were received properly, or 0 if this is a request for a full retraining sequence
6	Transmit Antenna Selection Sounding Indication requesting feedback of explicit CSI (TXASSI-CSI)	Number of remaining sounding PPDU's to be transmitted 0 to 15
		See NOTE
7	Reserved	Reserved

NOTE—If the HT variant HT Control field is carried in a sounding PPDU, then the value of the ASEL Data field contains the remaining number of sounding frames following the current one. If null data packet (NDP) sounding frame is used, then the value in the ASEL Data field contains the number of NDP's following a non-NDP+HTC. The HT NDP Announcement subfield in the HT Control field is set to 1 to indicate NDP sounding.

Source: [IEEE 802.11-2016 Standard](#) (Page 657)

84. TCL directly infringes the '096 Patent when, for example, it and/or its agents use the accused products, including during testing of the accused products. TCL also directly infringes the '096 Patent when the accused products are used after purchase by a customer or end

user. For example, the accused products are built with hardware and/or software components that control the operation of the accused products. These components cause the accused products to perform the steps of the claimed invention after, for example, receiving sounding packets. TCL also directly infringes the '096 Patent by exercising direction or control over the use of the accused products by others, including its affiliates, its subsidiaries, its business partners (including certification and testing organizations), and/or its customers and end-users. TCL contracts with, advises, and/or encourages such persons to engage in conduct satisfying one or more elements of the asserted claims, deriving a financial or other benefit (e.g., improved wireless communications) from doing so. TCL conditions these benefits on, for example, such persons performing certain activities involving the accused products during specified conditions that cause the accused products to perform the steps of the claimed method (e.g., after receiving sounding packets).

85. TCL has had knowledge of the '096 Patent at least as of the date when it was notified of the filing of this action.

86. Freedom Patents has been damaged as a result of the infringing conduct by TCL alleged above. Thus, TCL is liable to Freedom Patents in an amount that adequately compensates it for such infringements, which, by law, cannot be less than a reasonable royalty, together with interest and costs as fixed by this Court under 35 U.S.C. § 284.

87. Freedom Patents has neither made nor sold unmarked articles that practice the '096 Patent, and is entitled to collect pre-filing damages for the full period allowed by law for infringement of the '096 Patent.

**COUNT III**

**DIRECT INFRINGEMENT OF U.S. PATENT NO. 8,514,815**

88. On August 20, 2013, United States Patent No. 8,514,815 (“the ’815 Patent”) was duly and legally issued by the United States Patent and Trademark Office for an invention entitled “Training Signals for Selecting Antennas and Beams in MIMO Wireless LANs.”

89. Freedom Patents is the owner of the ’815 Patent, with all substantive rights in and to that patent, including the sole and exclusive right to prosecute this action and enforce the ’815 Patent against infringers, and to collect damages for all relevant times.

90. TCL used products and/or systems including, for example, its TCL 65S455 (with 2x2 MIMO) family of TVs, the Alcatel LINKZONE 4G LTE Cat4 Mobile Wi-Fi (with 2x2 MIMO),<sup>21</sup> and other products<sup>22</sup> that implement MIMO Wi-Fi capabilities (“accused products”):

---

<sup>21</sup> The Alcatel LINKZONE 4G LTE Cat4 Mobile Wi-Fi has the TCL model number MW41NF. *See, e.g.*, <https://deviceatlas.com/device-data/devices/alcatel/mw41nf/46919001>.

<sup>22</sup> *See, e.g.*, TCL Smart TV 3-Series (32S356, 32S327, 40S325, 43S325, 28S305, 32S305, 40S305, 43S305, 49S305, 32S301, 32S321), Smart TV 4-Series (43S45, 43S453, 50S453, 55S453, 65S453, 75S453, 43S451, 50S451, 55S451, 65S451, 75S451, 85S451, 43S455, 50S455, 55S455, 58S455, 65S455, 75S455, 85S455, 43S446, 50S446, 55S446, 65S446, 75S446, 85S446, 43S431, 50S431, 55S431, 65S431, 75S431, 85S431, 43S435, 50S435, 55S435, 65S435, 75S435, 85S435, 43S434, 50S434, 55S434, 65S434, 70S434, 75S434, 55S41, 65S41, 55S21, 43S405, 49S405, 55S405, 65S405, 55S401, 65S401, 43S403, 49S403, 55S403, 65S403, 50S45, 75S45, 70S430, 75S433), Smart TV 5-Series (43S515, 49S515, 55S515, 65S515, 43S517, 49S517, 55S517, 65S517, 50T555, 55T555, 65T555, 75T555, 50S555, 55S555, 65S555, 75S555, 50S546, 55S546, 65S546, 75S546, 50S535, 55S535, 65S535, 75S535, 55T551, 65T551, 55S531, 65S531), Smart TV 6-Series (55R655, 65R655, 75R655, 85R655, 55R646, 65R646, 75R646, 55R635, 65R635, 75R635, 55R613, 55R615, 65R615, 75R615, 65R648, 75R648), TCL Smartphone 30 Series (T776O1-2AWFUS11, T776O1-2BWFUS11, T781S, T767W), Smartphone 20 Series (T810S-2BLCUS11, T810S-2ALCUS11, T768S, T768O, T773O-2AAZUS11, T773O-2BAZUS11), Smartphone A Series (5004S), Smartphone 10 Series (T799B-2ALCUS11, T799B-2BLCUS11, T790S, T770B-2ALCUS11), TCL Tablets (9198S, 9048S, 9049L, 9050S), TCL Stylus 5G (T779W), TCL LinkZone 5G (MW513UW), etc.



MODEL 65S455

### TCL 65" CLASS 4-SERIES 4K UHD HDR LED SMART ROKU TV - 65S455

Suggested Price

**\$429.99**

★★★★★ 4.5 (45) Write a review

WHERE TO BUY

Source: [www.tcl.com/us/en/products/home-theater/4-series/65-class-4-series-4k-uhd-led-smart-roku-tv-65s455](http://www.tcl.com/us/en/products/home-theater/4-series/65-class-4-series-4k-uhd-led-smart-roku-tv-65s455)

Wireless Connection	802.11ac 2x2 Dual Band (support 2.4GHz & 5GHz)
---------------------	--

Source: [www.tcl.com/us/en/products/home-theater/4-series/65-class-4-series-4k-uhd-led-smart-roku-tv-65s455](http://www.tcl.com/us/en/products/home-theater/4-series/65-class-4-series-4k-uhd-led-smart-roku-tv-65s455)

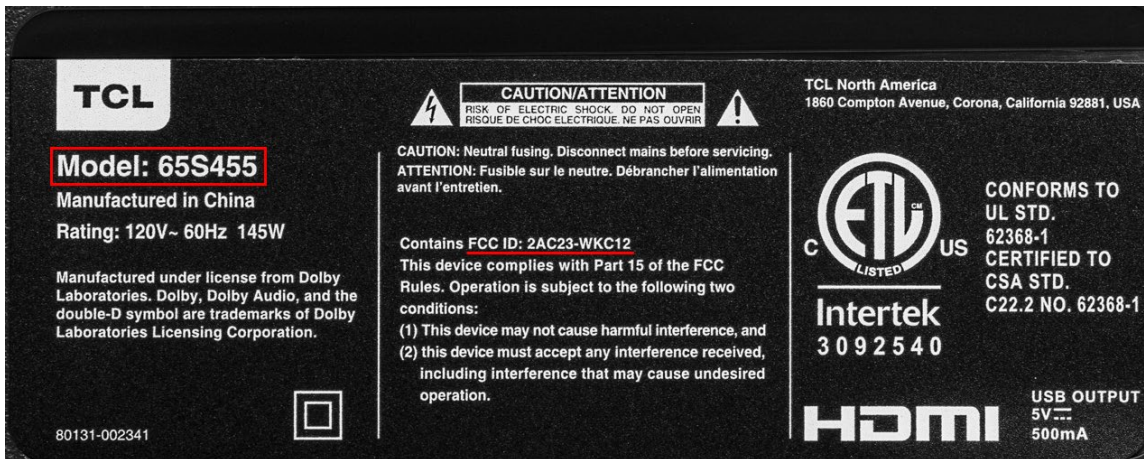

Source: [www.rtings.com/assets/products/gRVXk38E/tcl-4-series-s455-2022/label-large.jpg](http://www.rtings.com/assets/products/gRVXk38E/tcl-4-series-s455-2022/label-large.jpg)

## WIFI Module

**IEEE 802.11 a/b/g/n/ac 2T/2R**

**Model Number: WKC12R2501**

### Product Description

The WKC12R2501 is a complete dual-band(2.4GHz and 5GHz)WIFI 2x2 MIMO module. This module provides a high level of integration with a dual-stream IEEE 802.11ac MAC/ base band /radio.The WLAN operation supports 20MHz,40MHz and 80MHz channels for data rates up to 866.7Mbps. It fully complies with IEEE 802.11 a/b/g/n/ac feature rich wireless connectivity at high standards,delivers reliable,cost-effective, throughput from an extended distance.

Source: <https://fccid.io/2AC23-WKC12/Users-Manual/User-manual-5654192>



Source: [www.alcatelmobile.com/product/mobile-broadband/mobile-wifi/linkzone-cat4-mobile-wi-fi](http://www.alcatelmobile.com/product/mobile-broadband/mobile-wifi/linkzone-cat4-mobile-wi-fi)

#### ANTENNA

LTE: 2X2 MIMO  
WCDMA: Internal  
GSM: Internal  
Wi-Fi: Internal 2X2

Source: [www.alcatelmobile.com/product/mobile-broadband/mobile-wifi/linkzone-cat4-mobile-wi-fi](http://www.alcatelmobile.com/product/mobile-broadband/mobile-wifi/linkzone-cat4-mobile-wi-fi)

91. By doing so, TCL has directly infringed (literally and/or under the doctrine of equivalents) at least Claim 1 of the '815 Patent. TCL's infringement in this regard is ongoing.

92. The TCL 65S455 Smart TV and the Alcatel LINKZONE 4G LTE Cat4 Mobile Wi-Fi are exemplary accused products.

93. TCL has infringed the '815 Patent by using the accused products and thereby practicing a computer implemented method for selecting antennas in a multiple-input, multiple-output wireless local area network including a plurality of stations, each station includes a set of antennas.

94. For example, the TCL 65S455 Smart TV and the Alcatel LINKZONE 4G LTE Cat4 Mobile Wi-Fi communicate with other stations using the IEEE 802.11 protocol and include a set of antennas that are used for both transmitting and receiving data to and from the other stations over a WLAN. The transmission and reception of data using multiple antennas simultaneously is known as MIMO (“multiple-input, multiple-output”). The stations communicating using MIMO implement antenna selection by initially transmitting or receiving sounding packets with each other to estimate the channel characteristics between them. The sounding packets correspond to a set of antennas that are available from a larger number of antennas.

## **Part 11: Wireless LAN Medium Access Control (MAC) and Physical Layer (PHY) Specifications**

### **1. Overview**

#### **1.1 Scope**

The scope of this standard is to define one medium access control (MAC) and several physical layer (PHY) specifications for wireless connectivity for fixed, portable, and moving stations (STAs) within a local area.

Source: [IEEE 802.11-2016 Standard](#) (Page 122)

An HT STA has PHY features consisting of the modulation and coding scheme (MCS) set described in 19.3.5 and physical layer (PHY) protocol data unit (PPDU) formats described in 19.1.4. Some PHY features that distinguish an HT STA from a non-HT STA are referred to as *multiple input, multiple output (MIMO) operation*; spatial multiplexing (SM); spatial mapping (including transmit beamforming); space-time block coding (STBC); low-density parity check (LDPC) encoding; and antenna selection (ASEL). The allowed PPDU formats are non-HT format, HT-mixed format, and HT-greenfield format (see 19.1.4). The PPDUs can be transmitted with 20 MHz bandwidth and might be transmitted with 40 MHz bandwidth.

Source: [IEEE 802.11-2016 Standard](#) (Page 197)

**multiple input, multiple output (MIMO):** A physical layer (PHY) configuration in which both transmitter and receiver use multiple antennas.

Source: [IEEE 802.11-2016 Standard](#) (Page 136)

**multi-user multiple input, multiple output (MU-MIMO):** A technique by which multiple stations (STAs), each with one or more antennas, either simultaneously transmit to a single STA or simultaneously receive from a single STA independent data streams over the same radio frequencies.

NOTE—IEEE Std 802.11 supports only downlink (DL) MU-MIMO. See **downlink multi-user multiple input, multiple output (DL-MU-MIMO)** (in 3.2).

Source: [IEEE 802.11-2016 Standard](#) (Page 136)

## 10.31 Link adaptation

### 10.31.1 Introduction

To fully exploit MIMO channel variations and transmit beamforming on a MIMO link, a STA can request that another STA provide MIMO channel sounding and MFB.

Source: [IEEE 802.11-2016 Standard](#) (Page 1463)

### 10.30 Sounding PPDU

The behavior described in this subclause is specific to the use of the HT variant HT Control field.

A sounding PPDU is a PPDU for which the SOUNDING parameter of the corresponding RXVECTOR or TXVECTOR has the value SOUNDING. Sounding PPDUs are transmitted by STAs to enable the receiving STAs to estimate the channel between the transmitting STA and the receiving STA.

A STA transmits sounding PPDU when it operates in the following roles:

- MFB requester (see 10.31.2)
- HT beamformee responding to a training request, calibration initiator, or responder involved in implicit transmit beamforming (see 10.32.2.2, 10.32.2.3, and 10.32.2.4)
- HT beamformer involved in explicit transmit beamforming (see 10.32.3)
- ASEL transmitter and ASEL sounding-capable transmitter involved in ASEL (see 10.33.2)

A STA receives sounding PPDU when it operates in the following roles:

- MFB responder (see 10.31.2)
- HT beamformer sending a training request, calibration initiator, or responder involved in implicit transmit beamforming (see 10.32.2.2, 10.32.2.3, and 10.32.2.4)
- HT beamformee involved in explicit transmit beamforming (see 10.32.3)
- Transmit ASEL responder and ASEL receiver involved in ASEL (see 10.33.2)

Source: [IEEE 802.11-2016 Standard](#) (Pages 1462-63)

### 10.33 Antenna selection (ASEL)

#### 10.33.1 Introduction

The procedures in this subclause apply only to HT and non-HT PPDU for which the HT Control field, if present, is the HT variant HT Control field.

ASEL is a time-variant mapping of the signals at the RF chains onto a set of antenna elements when the number of RF chains is smaller than the number of antenna elements. The mapping might be chosen based on instantaneous or averaged CSI. ASEL requires the training of the full size channel associated with all antenna elements, which is obtained by transmitting or receiving sounding PPDU over all antennas. These sounding PPDU should be sent within a single TXOP. To avoid channel distortions, these sounding PPDU shall be transmitted consecutively. The training information is exchanged using the HT Control field. When both transmitter and receiver have ASEL capabilities, training of transmit and receive antennas might be done one after another. ASEL supports up to eight antennas and up to four RF chains.

Source: [IEEE 802.11-2016 Standard](#) (Page 1481)

95. The method practiced using the accused products includes the step of sending a number of sounding packets that are to be sent for antenna selection training, from a station to



perform the antenna selection training by receiving the sounding packets, to a station to transmit the sounding packets.

96. For example, during the antenna selection process, the ASEL receiver station (“a station to perform the antenna selection training by receiving the sounding packets”) initially transmits a +HTC frame with the ASEL Command subfield set to RXASSR (“Receive Antenna Selection Sounding Request”). The ASEL Data subfield indicates the number of sounding PPDUs required (“sending a number of sounding packets that are to be sent for antenna selection training”) from the ASEL sounding-capable transmitter station (“to a station to transmit the sounding packets”).

### **10.30 Sounding PPDUs**

The behavior described in this subclause is specific to the use of the HT variant HT Control field.

A sounding PPDU is a PPDU for which the SOUNDING parameter of the corresponding RXVECTOR or TXVECTOR has the value SOUNDING. Sounding PPDUs are transmitted by STAs to enable the receiving STAs to estimate the channel between the transmitting STA and the receiving STA.

A STA transmits sounding PPDUs when it operates in the following roles:

- MFB requester (see 10.31.2)
- HT beamformee responding to a training request, calibration initiator, or responder involved in implicit transmit beamforming (see 10.32.2.2, 10.32.2.3, and 10.32.2.4)
- HT beamformer involved in explicit transmit beamforming (see 10.32.3)
- ASEL transmitter and ASEL sounding-capable transmitter involved in ASEL (see 10.33.2)

A STA receives sounding PPDUs when it operates in the following roles:

- MFB responder (see 10.31.2)
- HT beamformer sending a training request, calibration initiator, or responder involved in implicit transmit beamforming (see 10.32.2.2, 10.32.2.3, and 10.32.2.4)
- HT beamformee involved in explicit transmit beamforming (see 10.32.3)
- Transmit ASEL responder and ASEL receiver involved in ASEL (see 10.33.2)

Source: [IEEE 802.11-2016 Standard](#) (Pages 1462-63)

### 10.33 Antenna selection (ASEL)

#### 10.33.1 Introduction

The procedures in this subclause apply only to HT and non-HT PPDU's for which the HT Control field, if present, is the HT variant HT Control field.

ASEL is a time-variant mapping of the signals at the RF chains onto a set of antenna elements when the number of RF chains is smaller than the number of antenna elements. The mapping might be chosen based on instantaneous or averaged CSI. ASEL requires the training of the full size channel associated with all antenna elements, which is obtained by transmitting or receiving sounding PPDU's over all antennas. These sounding PPDU's should be sent within a single TXOP. To avoid channel distortions, these sounding PPDU's shall be transmitted consecutively. The training information is exchanged using the HT Control field. When both transmitter and receiver have ASEL capabilities, training of transmit and receive antennas might be done one after another. ASEL supports up to eight antennas and up to four RF chains.

Source: [IEEE 802.11-2016 Standard](#) (Page 1481)

The frame exchange sequence for receive ASEL is shown in Figure 10-51, where the term *ASEL receiver* identifies the STA that is conducting receive ASEL, and the term *ASEL sounding-capable transmitter* identifies the STA sending the consecutive sounding PPDU's used for receive ASEL calculations. The frame exchange comprises the following steps:

- The ASEL receiver transmits a +HTC frame with the MAI subfield set to ASEL1, the ASEL Command subfield set to Receive Antenna Selection Sounding Request (RXASSR), and the ASEL Data subfield set to the number of sounding PPDU's required.

NOTE— For example, in the case of sounding over all disjointed antenna sets, the number of total consecutive sounding PPDU's or NDP's equals the smallest integer that is greater than or equal to the number of antennas divided by the number of RF chains.

Source: [IEEE 802.11-2016 Standard](#) (Page 1484)

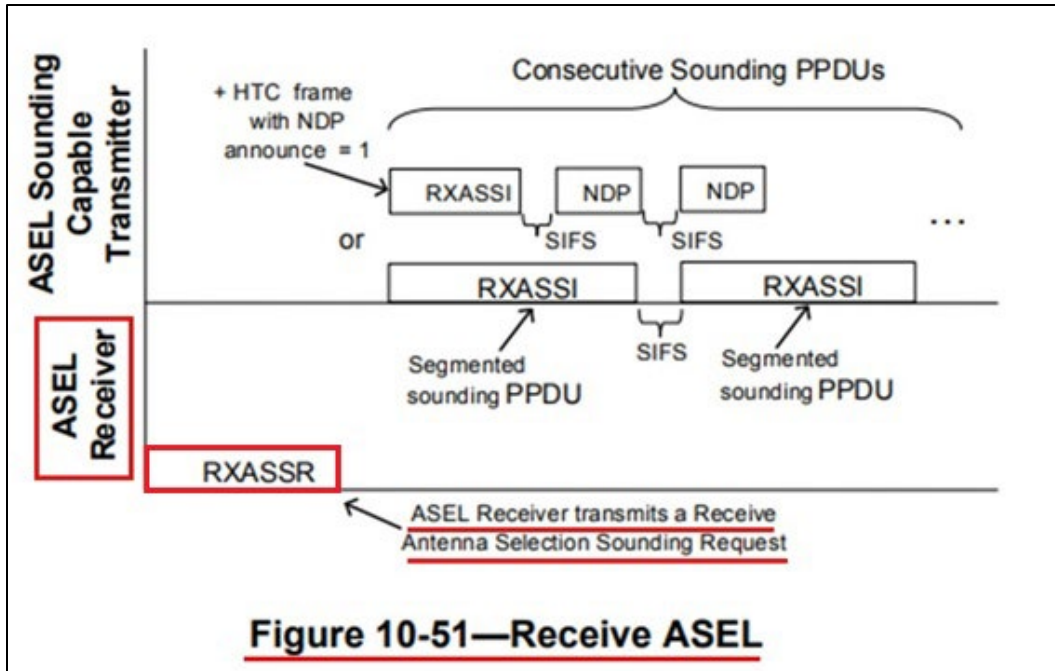

Source: [IEEE 802.11-2016 Standard](#) (Page 1484)

97. The method practiced using the accused products includes the step of transmitting multiple consecutively transmitted sounding packets, according to the number, by the station transmitting the sounding packets.

98. For example, the ASEL sounding-capable transmitter station ("station transmitting the sounding packets") receives the +HTC frame transmitted by the ASEL receiver station, which indicates the number of sounding PPDUs required for antenna selection. The ASEL sounding-capable transmitter station responds by consecutively transmitting multiple sounding PPDUs ("transmitting multiple consecutively transmitted sounding packets") as required by the ASEL receiver to perform antenna selection.

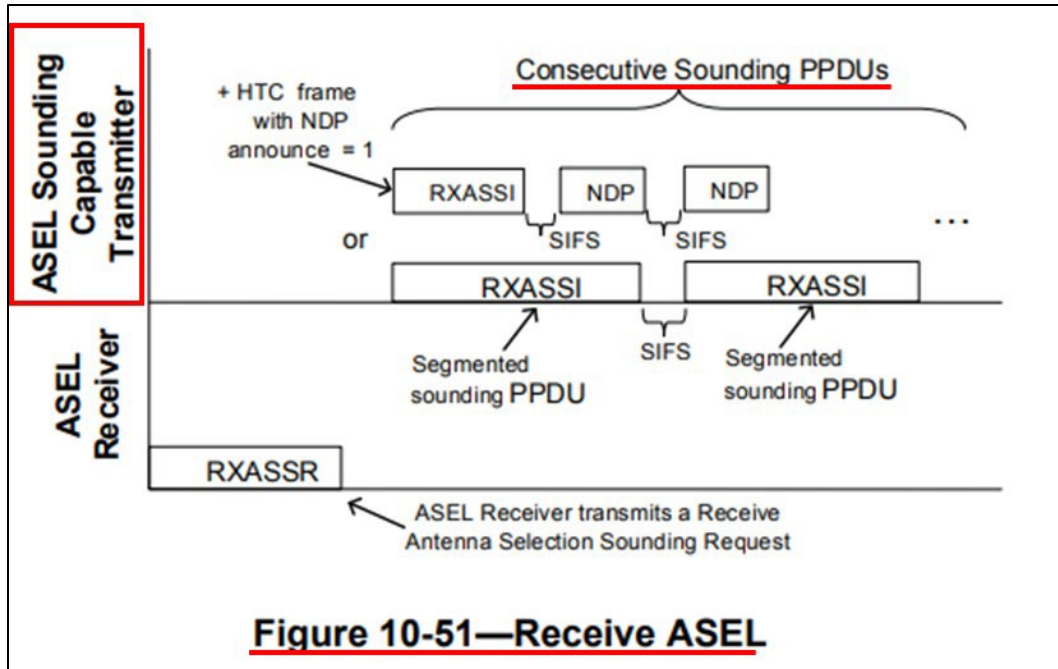

Source: [IEEE 802.11-2016 Standard](#) (Page 1484)

The frame exchange sequence for receive ASEL is shown in Figure 10-51, where the term *ASEL receiver* identifies the STA that is conducting receive ASEL, and the term *ASEL sounding-capable transmitter* identifies the STA sending the consecutive sounding PPDU's used for receive ASEL calculations. The frame exchange comprises the following steps:

- The ASEL receiver transmits a +HTC frame with the MAI subfield set to ASEL, the ASEL Command subfield set to Receive Antenna Selection Sounding Request (RXASSR), and the ASEL Data subfield set to the number of sounding PPDU's required.

NOTE— For example, in the case of sounding over all disjointed antenna sets, the number of total consecutive sounding PPDU's or NDP's equals the smallest integer that is greater than or equal to the number of antennas divided by the number of RF chains.

- The ASEL sounding-capable transmitter responds with the corresponding number of sounding PPDU's in its subsequent TXOP. These PPDU's are separated by SIFS. When using non-NDP sounding, each PPDU contains a +HTC frame in which the MAI subfield is set to ASEL, the ASEL Command subfield is set to Receive Antenna Selection Sounding Indication (RXASSI), and the ASEL Data subfield is set to the remaining number of sounding PPDU's to be transmitted. When using NDP sounding, the PPDU that precedes the first NDP contains a +HTC frame in which the NDP Announce field is set to 1, the MAI subfield is set to ASEL, the ASEL Command subfield is set to RXASSI, and the ASEL Data subfield is set to the remaining number of sounding PPDU's to be transmitted.

Source: [IEEE 802.11-2016 Standard](#) (Page 1484)

**10.30 Sounding PPDUs**

The behavior described in this subclause is specific to the use of the HT variant HT Control field.

A sounding PPDU is a PPDU for which the SOUNDING parameter of the corresponding RXVECTOR or TXVECTOR has the value SOUNDING. Sounding PPDUs are transmitted by STAs to enable the receiving STAs to estimate the channel between the transmitting STA and the receiving STA.

A STA transmits sounding PPDUs when it operates in the following roles:

- MFB requester (see 10.31.2)
- HT beamformee responding to a training request, calibration initiator, or responder involved in implicit transmit beamforming (see 10.32.2.2, 10.32.2.3, and 10.32.2.4)
- HT beamformer involved in explicit transmit beamforming (see 10.32.3)
- ASEL transmitter and ASEL sounding-capable transmitter involved in ASEL (see 10.33.2)

A STA receives sounding PPDUs when it operates in the following roles:

- MFB responder (see 10.31.2)
- HT beamformer sending a training request, calibration initiator, or responder involved in implicit transmit beamforming (see 10.32.2.2, 10.32.2.3, and 10.32.2.4)
- HT beamformee involved in explicit transmit beamforming (see 10.32.3)
- Transmit ASEL responder and ASEL receiver involved in ASEL (see 10.33.2)

**Source:** [IEEE 802.11-2016 Standard](#) (Pages 1462-63)

99. The method practiced using the accused products includes the step of receiving the multiple consecutively transmitted sounding packets in the station to perform the antenna selection training, wherein each sounding packet corresponding to a different subset of the set of antennas, and where the number of consecutive packets is predetermined.

100. For example, the ASEL receiver station receives multiple consecutive sounding PPDUs (“receiving the multiple consecutively transmitted sounding packets”) sent by the ASEL sounding-capable transmitter station. The number of received multiple sounding packets corresponds to the number required to be sent by the ASEL sounding-capable transmitter (“where the number of consecutive packets is predetermined”). The ASEL receiver station receives the multiple consecutively transmitted sounding PPDUs and estimates the channel state information (along with the channel matrices for each channel) based on the measurements from

the received sounding PPDU, each of which corresponds to a different set of antennas (“each sounding packet corresponding to a different subset of the set of antennas”). Based on the estimated channel matrices, the ASEL receiver performs antenna selection (“to perform the antenna selection training”).

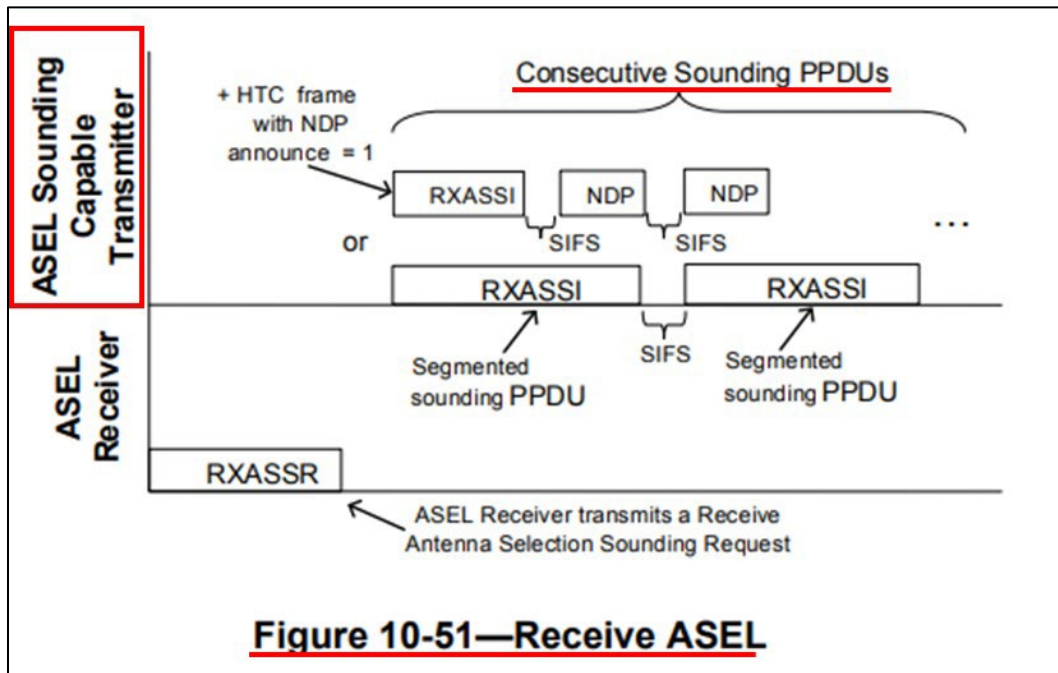

Source: [IEEE 802.11-2016 Standard](#) (Page 1484)

### 10.33 Antenna selection (ASEL)

#### 10.33.1 Introduction

The procedures in this subclause apply only to HT and non-HT PPDU for which the HT Control field, if present, is the HT variant HT Control field.

ASEL is a time-variant mapping of the signals at the RF chains onto a set of antenna elements when the number of RF chains is smaller than the number of antenna elements. The mapping might be chosen based on instantaneous or averaged CSI. ASEL requires the training of the full size channel associated with all antenna elements, which is obtained by transmitting or receiving sounding PPDU over all antennas. These sounding PPDU should be sent within a single TXOP. To avoid channel distortions, these sounding PPDU shall be transmitted consecutively. The training information is exchanged using the HT Control field. When both transmitter and receiver have ASEL capabilities, training of transmit and receive antennas might be done one after another. ASEL supports up to eight antennas and up to four RF chains.

Source: [IEEE 802.11-2016 Standard](#) (Page 1481)

The frame exchange sequence for receive ASEL is shown in Figure 10-51, where the term *ASEL receiver* identifies the STA that is conducting receive ASEL, and the term *ASEL sounding-capable transmitter* identifies the STA sending the consecutive sounding PPDU used for receive ASEL calculations. The frame exchange comprises the following steps:

- The ASEL receiver transmits a +HTC frame with the MAI subfield set to ASEL, the ASEL Command subfield set to Receive Antenna Selection Sounding Request (RXASSR), and the ASEL Data subfield set to the number of sounding PPDU required.

NOTE— For example, in the case of sounding over all disjointed antenna sets, the number of total consecutive sounding PPDU or NDPs equals the smallest integer that is greater than or equal to the number of antennas divided by the number of RF chains.

- The *ASEL sounding-capable transmitter* responds with the corresponding number of sounding PPDU in its subsequent TXOP. These PPDU are separated by SIFS. When using non-NDP sounding, each PPDU contains a +HTC frame in which the MAI subfield is set to ASEL, the ASEL Command subfield is set to Receive Antenna Selection Sounding Indication (RXASSI), and the ASEL Data subfield is set to the remaining number of sounding PPDU to be transmitted. When using NDP sounding, the PPDU that precedes the first NDP contains a +HTC frame in which the NDP Announce field is set to 1, the MAI subfield is set to ASEL, the ASEL Command subfield is set to RXASSI, and the ASEL Data subfield is set to the remaining number of sounding PPDU to be transmitted.

Source: [IEEE 802.11-2016 Standard](#) (Page 1484)

The ASEL receiver uses different antenna sets to receive these sounding PPDU, estimates CSI after receiving all these sounding PPDU, and conducts the ASEL.

Source: [IEEE 802.11-2016 Standard](#) (Page 1484)

### **10.30 Sounding PPDU**

The behavior described in this subclause is specific to the use of the HT variant HT Control field.

A sounding PPDU is a PPDU for which the SOUNDING parameter of the corresponding RXVECTOR or TXVECTOR has the value SOUNDING. Sounding PPDUs are transmitted by STAs to enable the receiving STAs to estimate the channel between the transmitting STA and the receiving STA.

A STA transmits sounding PPDUs when it operates in the following roles:

- MFB requester (see 10.31.2)
- HT beamformee responding to a training request, calibration initiator, or responder involved in implicit transmit beamforming (see 10.32.2.2, 10.32.2.3, and 10.32.2.4)
- HT beamformer involved in explicit transmit beamforming (see 10.32.3)
- ASEL transmitter and ASEL sounding-capable transmitter involved in ASEL (see 10.33.2)

A STA receives sounding PPDUs when it operates in the following roles:

- MFB responder (see 10.31.2)
- HT beamformer sending a training request, calibration initiator, or responder involved in implicit transmit beamforming (see 10.32.2.2, 10.32.2.3, and 10.32.2.4)
- HT beamformee involved in explicit transmit beamforming (see 10.32.3)
- Transmit ASEL responder and ASEL receiver involved in ASEL (see 10.33.2)

**Source:** [IEEE 802.11-2016 Standard](#) (Pages 1462-63)

101. The method practiced using the accused products includes the step of estimating a channel matrix from the multiple consecutively transmitted sounding packets.

102. For example, the ASEL sounding-capable transmitter station transmits multiple sounding PPDU's ("multiple consecutively transmitted sounding packets") to the ASEL receiver. The ASEL receiver station estimates the channel state information based on the measurements from each of the received sounding PPDU's, which correspond to a different set of antennas. After the estimate is complete, a Channel State Information report (CSI report) is generated. The CSI report is part of the CSI frame format, and is present as a CSI Report field. The CSI Report field contains a Channel Matrix subfield, which contains the channel matrices estimated for the different channels.



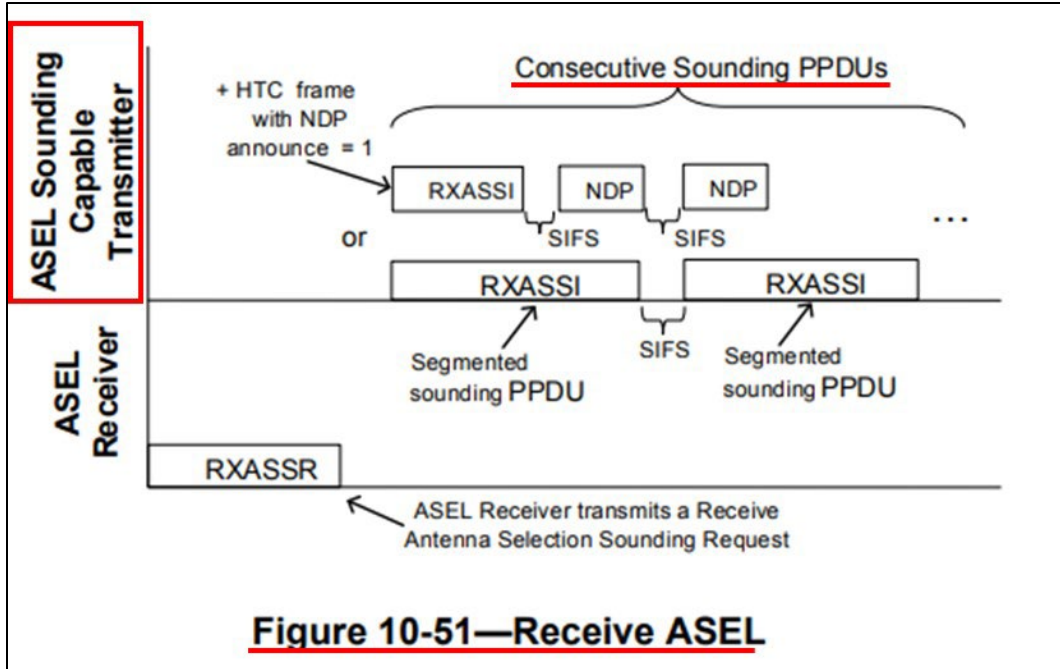

Source: [IEEE 802.11-2016 Standard](#) (Page 1484)

The ASEL receiver uses different antenna sets to receive these sounding PPDU's, estimates CSI after receiving all these sounding PPDU's, and conducts the ASEL.

Source: [IEEE 802.11-2016 Standard](#) (Page 1484)

**19.3.13.3 Sounding PDU for calibration**

In the case of a bidirectional calibration exchange, two STAs exchange sounding PPDU's, the exchange of which enables the receiving STA to compute an estimate of the MIMO channel matrix  $H_k$  for each subcarrier  $k$ . In general, in an exchange of calibration messages, the number of spatial streams is less than the number of transmit antennas. In such cases, HT-ELTFs are used. In the case of sounding PPDU's for calibration, the antenna mapping matrix shall be as shown in Equation (19-86).

$$Q_k = C_{CSD}(k)P_{CAL} \tag{19-86}$$

Source: [IEEE 802.11-2016 Standard](#) (Page 2401)

When the MIMO channel measurements become available at STA B, STA B shall send one or more CSI frames that contain the CSI report (Step 2 in Figure 10-47). This CSI report shall have full precision, i.e.,  $N_g=1$  (no grouping) and  $N_b=3$  (8 bits). In these CSI frames, the Calibration Sequence subfields in HT Control fields shall be set to the same value that is indicated in the Calibration Sounding Complete frame. These CSI frames shall have a frame type of Management Action +HTC.

Source: [IEEE 802.11-2016 Standard](#) (Page 1477)

**9.6.12.6 CSI frame format**

The CSI frame is an Action or an Action No Ack frame of category HT. The format of its Action field is defined in Table 9-338.

**Table 9-338—CSI frame Action field format**

Order	Information
1	Category
2	HT Action
3	MIMO Control (see 9.4.1.27)
4	<u>CSI Report</u> (see 9.4.1.28)

Source: [IEEE 802.11-2016 Standard](#) (Page 1214)

**9.4.1.28 CSI Report field**

The CSI Report field is used by the CSI frame (see 9.6.12.6) to carry explicit channel state information to a transmit HT beamformer, as described in 10.32.3.

The CSI Matrix subfields in the CSI Report field shown in Table 9-52 and Table 9-53 are matrices whose elements are taken from the CHAN\_MAT parameter of RXVECTOR (see Table 19-1).

**Table 9-52—CSI Report field (20 MHz)**

Field	Size (bits)	Meaning
SNR in receive chain 1	8	Signal-to-noise ratio in the first receive chain of the STA sending the report.
...		
SNR in receive chain $N_r$	8	Signal-to-noise ratio in the $N_r$ 'th receive chain of the STA sending the report.
<u>CSI Matrix for carrier -28</u>	$3+2 \times N_b \times N_c \times N_r$	<u>CSI matrix (see Figure 9-95)</u>
...		

Source: [IEEE 802.11-2016 Standard](#) (Page 746)

Parameter	Condition	Value	TXVECTOR	RXVECTOR
			See NOTE 1	
CHAN_MAT	CHAN_MAT_TYPE is COMPRESSED_SV	Contains a set of compressed beamforming feedback matrices as defined in 19.3.12.3.6 based on the channel measured during the training symbols of the received PPDU. The number of elements depends on the number of spatial streams and the number of transmit chains.	N	Y
	CHAN_MAT_TYPE is NON_COMPRESSED_SV	Contains a set of noncompressed beamforming feedback matrices as defined in 19.3.12.3.5 based on the channel measured during the training symbols of the received PPDU. The number of complex elements is $N_{ST} \times N_r \times N_c$ where $N_{ST}$ is the total number of subcarriers, $N_c$ is the number of columns, and $N_r$ is the number of rows in each matrix.	N	Y
	CHAN_MAT_TYPE is CSI_MATRICES	Contains a set of CSI matrices as defined in 19.3.12.3.2 based on the channel measured during the training symbols of the received PPDU. The number of complex elements is $N_{ST} \times N_r \times N_c$ where $N_{ST}$ is the total number of subcarriers, $N_c$ is the number of columns, and $N_r$ is the number of rows in each matrix.	N	Y
	Otherwise	Not present	N	N
CHAN_MAT_TYPE	FORMAT is HT_MF or HT_GF	Enumerated type: COMPRESSED_SV indicates that CHAN_MAT is a set of compressed beamforming vector matrices. NON_COMPRESSED_SV indicates that CHAN_MAT is a set of noncompressed beamforming vector matrices. <u>CSI_MATRICES indicates that CHAN_MAT is a set of channel state matrices.</u>	N	Y
	Otherwise	Not present	N	N

Source: [IEEE 802.11-2016 Standard](#) (Pages 2340-41)

103. The method practiced using the accused products includes the step of selecting a subset of antennas according to the channel matrix.

104. For example, the ASEL receiver station receives the sounding PPDUs, estimates the CSI, and generates a Channel State Information report (CSI report). Based on the estimated channel matrices present in the CSI report, antenna selection is performed (“selecting a subset of antennas according to the channel matrix”).

When the MIMO channel measurements become available at STA B, STA B shall send one or more CSI frames that contain the CSI report (Step 2 in Figure 10-47). This CSI report shall have full precision, i.e.  $N_g=1$  (no grouping) and  $N_b=3$  (8 bits). In these CSI frames, the Calibration Sequence subfields in HT Control fields shall be set to the same value that is indicated in the Calibration Sounding Complete frame. These CSI frames shall have a frame type of Management Action +HTC.

Source: [IEEE 802.11-2016 Standard](#) (Page 1477)

**9.6.12.6 CSI frame format**

The CSI frame is an Action or an Action No Ack frame of category HT. The format of its Action field is defined in Table 9-338.

**Table 9-338—CSI frame Action field format**

Order	Information
1	Category
2	HT Action
3	MIMO Control (see 9.4.1.27)
4	<u>CSI Report</u> (see 9.4.1.28)

Source: [IEEE 802.11-2016 Standard](#) (Page 1214)

**9.4.1.28 CSI Report field**

The CSI Report field is used by the CSI frame (see 9.6.12.6) to carry explicit channel state information to a transmit HT beamformer, as described in 10.32.3.

The CSI Matrix subfields in the CSI Report field shown in Table 9-52 and Table 9-53 are matrices whose elements are taken from the CHAN\_MAT parameter of RXVECTOR (see Table 19-1).

**Table 9-52—CSI Report field (20 MHz)**

Field	Size (bits)	Meaning
SNR in receive chain 1	8	Signal-to-noise ratio in the first receive chain of the STA sending the report.
...		
SNR in receive chain $N_r$	8	Signal-to-noise ratio in the $N_r$ 'th receive chain of the STA sending the report.
<u>CSI Matrix for carrier -28</u>	$3+2 \times N_b \times N_c \times N_r$	<u>CSI matrix (see Figure 9-95)</u>
...		

Source: [IEEE 802.11-2016 Standard](#) (Page 746)

### 10.33 Antenna selection (ASEL)

#### 10.33.1 Introduction

The procedures in this subclause apply only to HT and non-HT PPDU's for which the HT Control field, if present, is the HT variant HT Control field.

ASEL is a time-variant mapping of the signals at the RF chains onto a set of antenna elements when the number of RF chains is smaller than the number of antenna elements. The mapping might be chosen based on instantaneous or averaged CSI. ASEL requires the training of the full size channel associated with all antenna elements, which is obtained by transmitting or receiving sounding PPDU's over all antennas. These sounding PPDU's should be sent within a single TXOP. To avoid channel distortions, these sounding PPDU's shall be transmitted consecutively. The training information is exchanged using the HT Control field. When both transmitter and receiver have ASEL capabilities, training of transmit and receive antennas might be done one after another. ASEL supports up to eight antennas and up to four RF chains.

Source: [IEEE 802.11-2016 Standard](#) (Page 1481)

**Antenna Selection.** There are  $M$  columns and  $N$  rows in the CSI matrix  $\mathbf{H}$ ; each corresponds to one transmit or receive antenna. To compute the Effective CSI that would be used under a particular antenna selection, we simply pick the subset of rows and columns that correspond to the desired antennas. Note that this includes both transmit antenna selection (e.g., when  $S < M$ , pick the best  $S$  of the  $M$  transmit antennas to send with) and receive antenna selection (e.g., when  $N > S$ , turn off the least useful of the excess antennas in order to reduce power consumption).

Source: <https://arxiv.org/ftp/arxiv/papers/1301/1301.6644.pdf> (Page 76)

105. TCL directly infringes the '815 Patent when, for example, it and/or its agents use the accused products, including during testing of the accused products. TCL also directly infringes the '815 Patent when the accused products are used after purchase by a customer or end user. For example, the accused products are built with hardware and/or software components that control the operation of the accused products. These components cause the accused products to perform the steps of the claimed invention after, for example, receiving sounding packets. TCL also directly infringes the '815 Patent by exercising direction or control over the use of the accused products by others, including its affiliates, its subsidiaries, its business partners (including certification and testing organizations), and/or its customers and end-

users. TCL contracts with, advises, and/or encourages such persons to engage in conduct satisfying one or more elements of the asserted claims, deriving a financial or other benefit (e.g., improved wireless communications) from doing so. TCL conditions these benefits on, for example, such persons performing certain activities involving the accused products during specified conditions that cause the accused products to perform the steps of the claimed method (e.g., after receiving sounding packets).

106. TCL has had knowledge of the '815 Patent at least as of the date when it was notified of the filing of this action.

107. Freedom Patents has been damaged as a result of the infringing conduct by TCL alleged above. Thus, TCL is liable to Freedom Patents in an amount that adequately compensates it for such infringements, which, by law, cannot be less than a reasonable royalty, together with interest and costs as fixed by this Court under 35 U.S.C. § 284.

108. Freedom Patents has neither made nor sold unmarked articles that practice the '815 Patent, and is entitled to collect pre-filing damages for the full period allowed by law for infringement of the '815 Patent.

**ADDITIONAL ALLEGATIONS REGARDING INFRINGEMENT  
AND PERSONAL JURISDICTION**

109. TCL has also indirectly infringed the '686 Patent, the '096 Patent, and the '815 Patent by inducing others to directly infringe the '686 Patent, the '096 Patent, and the '815 Patent.

110. TCL has induced the end users and/or TCL's customers to directly infringe (literally and/or under the doctrine of equivalents) the '686 Patent, the '096 Patent, and the '815 Patent by using the accused products.

111. TCL took active steps, directly and/or through contractual relationships with others, with the specific intent to cause them to use the accused products in a manner that infringes one or more claims of the '686 Patent, the '096 Patent, and the '815 Patent, including, for example, claims 1 and 21 of the '686 Patent, claim 1 of the '096 Patent, and claim 1 of the '815 Patent.

112. Such steps by TCL included, among other things, advising or directing customers, end users, and others (including distributors and equipment services entities) to use the accused products in an infringing manner; advertising and promoting the use of the accused products in an infringing manner; and/or distributing instructions that guide users to use the accused products in an infringing manner.

113. TCL performed these steps, which constitute joint and/or induced infringement, with the knowledge of the '686 Patent, the '096 Patent, and the '815 Patent and with the knowledge that the induced acts constitute infringement.

114. TCL was and is aware that the normal and customary use of the accused products by TCL's customers would infringe the '686 Patent, the '096 Patent, and the '815 Patent. TCL's inducement is ongoing.

115. TCL has also induced its affiliates, or third-party manufacturers, shippers, distributors, retailers, or other persons acting on its or its affiliates' behalf, to directly infringe (literally and/or under the doctrine of equivalents) at least claim 21 of the '686 Patent by importing, selling or offering to sell the accused products.

116. TCL has a significant role in placing the accused products in the stream of commerce with the expectation and knowledge that they will be purchased by consumers in Texas and elsewhere in the United States.

117. TCL purposefully directs or controls the making of accused products and their shipment to the United States, using established distribution channels, for sale in Texas and elsewhere within the United States.

118. TCL purposefully directs or controls the sale of the accused products into established United States distribution channels, including sales to nationwide retailers and wholesalers, including, for example, Amazon, Best Buy, Target, and Walmart. TCL's established United States distribution channels include one or more United States based affiliates (e.g., TTE Technology, Inc. d/b/a TCL North America, TCT Mobile, Inc., etc.) and third-parties working on behalf of TCL.

119. TCL purposefully directs or controls the sale of the accused products online and in nationwide retailers and wholesalers, including for sale in Texas and elsewhere in the United States, and expects and intends that the accused products will be so sold.

120. TCL purposefully places the accused products—whether by itself or through subsidiaries, affiliates, or third parties—into an international supply chain, knowing that the accused products will be sold in the United States, including Texas. Therefore, TCL also facilitates the sale of the accused products in Texas.

121. TCL took active steps, directly and/or through contractual relationships with others, with the specific intent to cause such persons to import, sell, or offer to sell the accused products in a manner that infringes claim 21 of the '686 Patent.

122. Such steps by TCL included, among other things, making or selling the accused products outside of the United States for importation into or sale in the United States, or knowing that such importation or sale would occur; and directing, facilitating, or influencing its affiliates,



or third-party manufacturers, shippers, distributors, retailers, or other persons acting on its or its affiliates' behalf, to import, sell, or offer to sell the accused products in an infringing manner.

123. TCL performed these steps, which constitute induced infringement, with the knowledge of the '686 Patent, the '096 Patent, and the '815 Patent, and with the knowledge that the induced acts would constitute infringement.

124. TCL performed such steps in order to profit from the eventual sale of the accused products in the United States.

125. TCL's inducement is ongoing.

126. TCL has also indirectly infringed by contributing to the infringement of the '686 Patent, the '096 Patent, and the '815 Patent. TCL has contributed to the direct infringement of the '686 Patent, the '096 Patent, and the '815 Patent by the end user of the accused products.

127. The accused products have special features that are specially designed to be used in an infringing way and that have no substantial uses other than ones that infringe the '686 Patent, the '096 Patent, and the '815 Patent, including, for example, claims 1 and 21 of the '686 Patent, claim 1 of the '096 Patent, and claim 1 of the '815 Patent.

128. The special features include, for example, hardware and/or software components especially adapted for transmitting/receiving sounding packets and estimating channel matrices for the selection of antennas in a multiple-input, multiple-output wireless network, used in a manner that infringes the '686 Patent, the '096 Patent, and the '815 Patent.

129. These special features constitute a material part of the invention of one or more of the claims of the '686 Patent, the '096 Patent, and the '815 Patent, and are not staple articles of commerce suitable for substantial non-infringing use.

130. TCL's contributory infringement is ongoing.

131. TCL has had actual knowledge of the '686 Patent, the '096 Patent, and the '815 Patent at least as of the date when it was notified of the filing of this action. Since at least that time, TCL has known the scope of the claims of the '686 Patent, the '096 Patent, and the '815 Patent, the products that practice the '686 Patent, the '096 Patent, and the '815 Patent, and that Freedom Patents is the owner of the '686 Patent, the '096 Patent, and the '815 Patent.

132. By the time of trial, TCL will have known and intended (since receiving such notice) that its continued actions would infringe and actively induce and contribute to the infringement of one or more claims of the '686 Patent, the '096 Patent, and the '815 Patent.

133. Furthermore, TCL has a policy or practice of not reviewing the patents of others (including instructing their employees to not review the patents of others), and thus has been willfully blind of Freedom Patents' patent rights. *See, e.g.*, M. Lemley, "Ignoring Patents," 2008 Mich. St. L. Rev. 19 (2008).

134. TCL's customers have infringed the '686 Patent, the '096 Patent, and the '815 Patent. TCL encouraged its customers' infringement.

135. TCL's direct and indirect infringement of the '686 Patent, the '096 Patent, and the '815 Patent has been, and/or continues to be willful, intentional, deliberate, and/or in conscious disregard of Freedom Patents' rights under the patents-in-suit.

136. Freedom Patents has been damaged as a result of TCL's infringing conduct alleged above. Thus, TCL is liable to Freedom Patents in an amount that adequately compensates it for such infringements, which, by law, cannot be less than a reasonable royalty, together with interest and costs as fixed by this Court under 35 U.S.C. § 284.

### **JURY DEMAND**

Freedom Patents hereby requests a trial by jury on all issues so triable by right.

**PRAYER FOR RELIEF**

Freedom Patents requests that the Court find in its favor and against TCL, and that the Court grant Freedom Patents the following relief:

a. Judgment that one or more claims of the '686 Patent, the '096 Patent, and the '815 Patent have been infringed, either literally and/or under the doctrine of equivalents, by TCL and/or all others acting in concert therewith;

b. A permanent injunction enjoining TCL and its officers, directors, agents, servants, affiliates, employees, divisions, branches, subsidiaries, parents, and all others acting in concert therewith from infringement of the '686 Patent, the '096 Patent, and the '815 Patent; or, in the alternative, an award of a reasonable ongoing royalty for future infringement of the '686 Patent, the '096 Patent, and the '815 Patent by such entities;

c. Judgment that TCL account for and pay to Freedom Patents all damages to and costs incurred by Freedom Patents because of TCL's infringing activities and other conduct complained of herein, including an award of all increased damages to which Freedom Patents is entitled under 35 U.S.C. § 284;

d. That Freedom Patents be granted pre-judgment and post-judgment interest on the damages caused by TCL's infringing activities and other conduct complained of herein;

e. That this Court declare this an exceptional case and award Freedom Patents its reasonable attorney's fees and costs in accordance with 35 U.S.C. § 285; and

f. That Freedom Patents be granted such other and further relief as the Court may deem just and proper under the circumstances.

Dated: May 10, 2023

Respectfully submitted,

/s/ Zachariah S. Harrington

Matthew J. Antonelli

Texas Bar No. 24068432

matt@ahtlawfirm.com

Zachariah S. Harrington

Texas Bar No. 24057886

zac@ahtlawfirm.com

Larry D. Thompson, Jr.

Texas Bar No. 24051428

larry@ahtlawfirm.com

Rehan M. Safiullah

Texas Bar No. 24066017

rehan@ahtlawfirm.com

ANTONELLI, HARRINGTON

& THOMPSON LLP

4306 Yoakum Blvd., Ste. 450

Houston, TX 77006

(713) 581-3000

Stafford Davis

State Bar No. 24054605

sdavis@stafforddavisfirm.com

Catherine Bartles

Texas Bar No. 24104849

cbartles@stafforddavisfirm.com

THE STAFFORD DAVIS FIRM

815 South Broadway Avenue

Tyler, Texas 75701

(903) 593-7000

(903) 705-7369 fax

*Attorneys for Freedom Patents LLC*