

**IN THE UNITED STATES DISTRICT COURT
FOR THE EASTERN DISTRICT OF PENNSYLVANIA**

YYZ, LLC,	:	
	:	
Plaintiff,	:	
	:	Civil Action NO. _____
v.	:	
	:	
MetaStorm, Inc.,	:	
	:	
Defendant.	:	
	:	

COMPLAINT FOR PATENT INFRINGEMENT

Plaintiff YYZ, LLC (“YYZ”) files this Complaint for damages and injunctive relief against MetaStorm, Inc., and in support of its Complaint, YYZ shows as follows:

THE PARTIES

1. YYZ is a corporation duly organized and existing under the laws of the Commonwealth of Pennsylvania, having its principal place of business in Chadds Ford, PA.
2. MetaStorm, Inc. (“MetaStorm”) is a Maryland corporation, and its principal place of business is located at 500 East Pratt Street, Suite 1250, Baltimore, Maryland 21202.

JURISDICTION

3. This Court has subject matter jurisdiction pursuant to 28 U.S.C. §§1331 and 1338(a) because this action arises under the patent laws of the United States, including 35 U.S.C. § 271 *et seq.* This Court has personal jurisdiction over the Defendant in that it has

committed acts within Pennsylvania and this judicial district giving rise to this action and the Defendant has established minimum contacts with the forum such that the exercise of jurisdiction over the Defendant would not offend traditional notions of fair play and substantial justice.

VENUE

4. The Defendant has committed acts within this judicial district giving rise to this action and does business in this district, including advertising and/or providing services to their respective customers in this district. Venue is proper in this district pursuant to 28 U.S.C. §§1391(b), 1391(c) and 1400(b).

INFRINGEMENT OF U.S. PATENT NO. 7,062,749

5. On June 13, 2006, United States Patent No. 7,062,749 (the “‘749 Patent”) was duly and legally issued for an invention entitled “Measuring, Monitoring and Tracking Enterprise Communications and Processes.” A true and correct copy of the ‘749 Patent is attached hereto as Exhibit A.

6. YYZ is the true and record owner of the ‘749 Patent.

7. Defendant has infringed and continues to infringe the ‘749 Patent, either directly or by contributory infringement or inducement of others to infringe. The infringing acts include, but are not limited to, the manufacture, use, sale, importation, and/or offer for sale of products and/or services related to measuring, monitoring and tracking enterprise communications and processes.

8. Defendant is liable for infringement of the ‘749 Patent pursuant to 35 U.S.C. § 271 and 35 U.S.C. § 154.

9. Defendant's acts of infringement has caused damage to YYZ, and YYZ is entitled to recover from Defendant the damages sustained by YYZ as a result of its wrongful acts in an amount subject to proof at trial.

10. Defendant's infringement of YYZ's exclusive rights under the '749 Patent will continue to damage YYZ's business, causing irreparable harm, for which there is no adequate remedy at law, unless it is enjoined by this Court.

11. Upon information and belief, Defendant's infringement of the '749 Patent is willful and deliberate, entitling YYZ to increased damages under 35 U.S.C. § 284 and to attorneys' fees and costs incurred in prosecuting this action under 35 U.S.C. § 285.

INFRINGEMENT OF U.S. PATENT NO. 7,603,674

12. On October 13, 2009, United States Patent No. 7,603,674 (the "'674 Patent") was duly and legally issued for an invention entitled "Apparatus and Systems for Measuring, Monitoring, Tracking and Simulating Enterprise Communications and Processes." A true and correct copy of the '674 Patent is attached hereto as Exhibit B.

13. YYZ is the true and record owner of the '674 Patent.

14. Defendant has infringed and continues to infringe the '674 Patent, either directly or by contributory infringement or inducement of others to infringe. The infringing acts include, but are not limited to, the manufacture, use, sale, importation, and/or offer for sale of products and/or services related to apparatus and systems for measuring, monitoring, tracking and simulating enterprise communications and processes.

15. Defendant is liable for infringement of the '674 Patent pursuant to 35 U.S.C. § 271 and 35 U.S.C. § 154.

16. Defendant's acts of infringement has caused damage to YYZ, and YYZ is entitled to recover from Defendant the damages sustained by YYZ as a result of its wrongful acts in an amount subject to proof at trial.

17. Defendant's infringement of YYZ's exclusive rights under the '674 Patent will continue to damage YYZ's business, causing irreparable harm, for which there is no adequate remedy at law, unless it is enjoined by this Court.

18. Upon information and belief, Defendant's infringement of the '674 Patent is willful and deliberate, entitling YYZ to increased damages under 35 U.S.C. § 284 and to attorneys' fees and costs incurred in prosecuting this action under 35 U.S.C. § 285.

PRAYER FOR RELIEF

WHEREFORE, YYZ prays for judgment and seeks relief against the Defendant as follows:

- (a) For Judgment that the '749 Patent has been and continues to be infringed by Defendant;
- (b) For Judgment that the '674 Patent has been and continues to be infringed by Defendant;
- (c) For an accounting of all damages sustained by YYZ as the result of the acts of infringement by Defendant;
- (d) For preliminary and permanent injunctions enjoining the aforesaid acts of infringement by Defendant, its officers, agents, servants, employees, subsidiaries and attorneys, and those persons acting in concert with them, including related individuals and entities, customers, representatives, dealers and

distributors;

(e) For actual damages together with prejudgment interest;

(f) For enhanced damages pursuant to 35 U.S.C. § 284 and 35 U.S.C. § 154;

(g) For an award of attorneys' fees pursuant to 35 U.S.C. § 285 or as otherwise permitted by law;

(h) For all costs of suit; and

(i) For such other and further relief as the Court may deem just and proper.

Respectfully submitted this 7th day of February 2011.



Joseph E. Chovanes, Esquire
5 Great Valley Parkway, Ste. 329
Malvern, PA 19355
jchovanes@chovanes.com
(610) 648-3994

Paul R. Fitzmaurice, P.C.
130 Linden Avenue
Haddonfield, NJ 08033
PaulRFitmaurice@gmail.com
(856) 287-4902

Counsel for Plaintiff YYZ, LLC

EXHIBIT A



US007062749B2

(12) **United States Patent**
Cyr et al.

(10) **Patent No.:** US 7,062,749 B2
(45) **Date of Patent:** Jun. 13, 2006

(54) **MEASURING, MONITORING AND TRACKING ENTERPRISE COMMUNICATIONS AND PROCESSES**

(75) Inventors: **Vincent R. Cyr**, Glen Mills, PA (US);
Kenneth Fritz, Glen Mills, PA (US)

(73) Assignee: **Promenix, Inc.**, Chadds Ford, PA (US)

(*) Notice: Subject to any disclaimer, the term of this patent is extended or adjusted under 35 U.S.C. 154(b) by 1109 days.

6,529,932 B1 *	3/2003	Dadiomov et al.	718/101
6,543,047 B1 *	4/2003	Vrhel et al.	717/121
6,553,438 B1 *	4/2003	Coffman et al.	710/52
6,601,233 B1 *	7/2003	Underwood	717/102
6,662,355 B1 *	12/2003	Caswell et al.	717/103
6,681,245 B1 *	1/2004	Sasagawa	709/206
6,725,445 B1	4/2004	Leymann et al.	
6,728,947 B1 *	4/2004	Bengston	717/103
6,757,710 B1 *	6/2004	Reed	709/203
6,789,252 B1 *	9/2004	Burke et al.	717/100
6,901,430 B1 *	5/2005	Smith	709/206
6,943,681 B1 *	9/2005	Rezvani et al.	340/506

OTHER PUBLICATIONS

(21) Appl. No.: **09/737,494**

(22) Filed: **Dec. 15, 2000**

(65) **Prior Publication Data**

US 2003/0225923 A1 Dec. 4, 2003

(51) **Int. Cl.**
G06F 9/44 (2006.01)

(52) **U.S. Cl.** 717/103; 705/9; 709/231

(58) **Field of Classification Search** 717/103;
705/9; 709/231; 719/314, 315, 316

See application file for complete search history.

“From EDI to Electronic Commerce A Business Initiative”, Phyllis K. Sokol, published Nov. 23, 1994.*
Workflow Template Developing A WFT Workflow System, Template Software, Whole book, copyright 1998.*
Workflow Template Using the WFT Development Environment, Template Software, Whole book, copyright 1998.*
Workflow Template Training Course, version 8.0, Section A, 1997, pp. 1-19.*
Web Component Using the Web Component, Template Software version 8.0, Chapters 1-3, 1997.*

(Continued)

Primary Examiner—Todd Ingberg

(56) **References Cited**

U.S. PATENT DOCUMENTS

5,404,501 A *	4/1995	Carr et al.	719/314
5,887,167 A *	3/1999	Sutton	719/314
5,949,998 A *	9/1999	Fowlow et al.	717/105
5,960,200 A *	9/1999	Eager et al.	717/147
6,018,627 A *	1/2000	Iyengar et al.	717/103
6,092,102 A	7/2000	Wagner	
6,208,345 B1 *	3/2001	Sheard et al.	345/853
6,397,191 B1 *	5/2002	Notani et al.	705/9
6,453,356 B1 *	9/2002	Sheard et al.	709/231
6,460,175 B1 *	10/2002	Ferri et al.	717/103
6,501,950 B1 *	12/2002	Smith et al.	455/423
6,510,429 B1 *	1/2003	Todd	705/36 R

(57) **ABSTRACT**

The present invention comprises apparatus and systems for measuring, monitoring, tracking and simulating enterprise communications and processes. A central message repository or database is constructed, comprised of monitoring messages sent from process messaging systems. The database may then be accessed or queried as desired. A simulation tool assists in reviewing present and proposed processes and sub-processes before modifying existent systems or creating new systems.

58 Claims, 8 Drawing Sheets

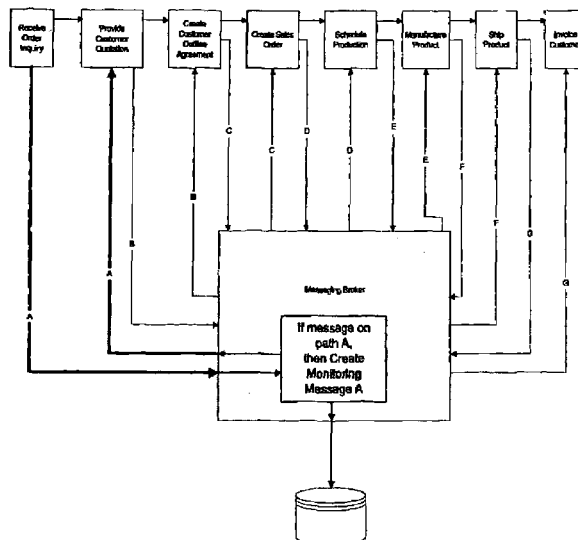

US 7,062,749 B2

Page 2

OTHER PUBLICATIONS

The XML Handbook, Charles F. Goldfarb et al, 1998, pp. 101-118.*

SNAP Using the SNAP Communication Component, Chapters 1-3, 1998.*

“Implementing SAP R/3 How to introduce a Large System into a Large Organization”, pp. 1-73, Nancy H. Bancroft et al, 1997.*

“SAP An Executive Comprehensive Guide”, Grant Norris et al, pp. 1-13, 1998.*

Windows NT Server Operating System, Microsoft Message Queuing Services, Microsoft, 1997, pp. 1-38.*

Messaging & Queuing Using the MQI, Burnie Blakey et al, Jun. 26, 1995, Whole Book.*

Building Distributed Applications with Message Queuing Middleware, Peter Houston, Microsoft Corporation, Mar. 1998, 7 pages.*

Special Issue on TP Monitors and Distributed Transaction Management, Ron Obermarck et al, Data Engineering, Mar. 1994, vol. 17, No. 1, IEEE Computer Society, 32 pages.*

“Remote Queues: Exposing Message Queues for Optimization and Atomicity”, Eric A. Brewer et al, ACM, 1995, pp. 42-53.*

* cited by examiner

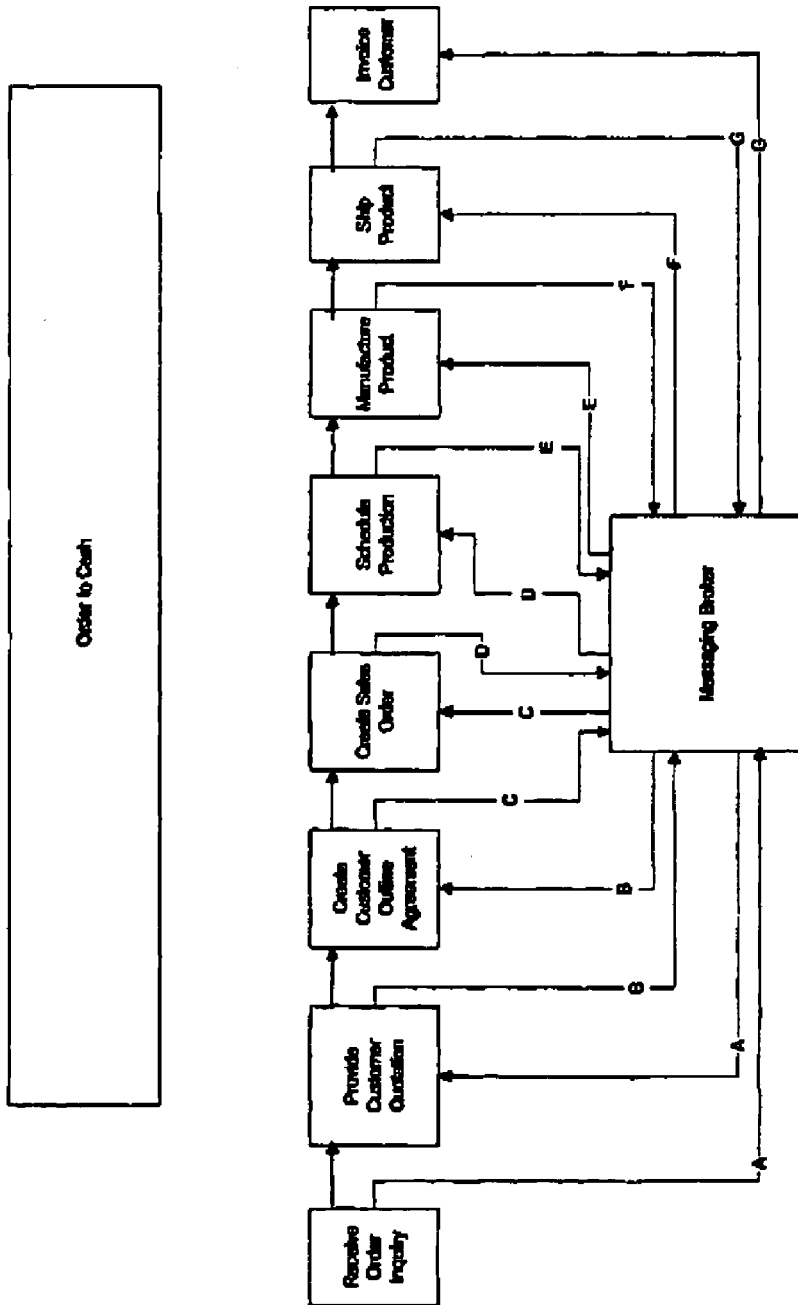

Figure 1

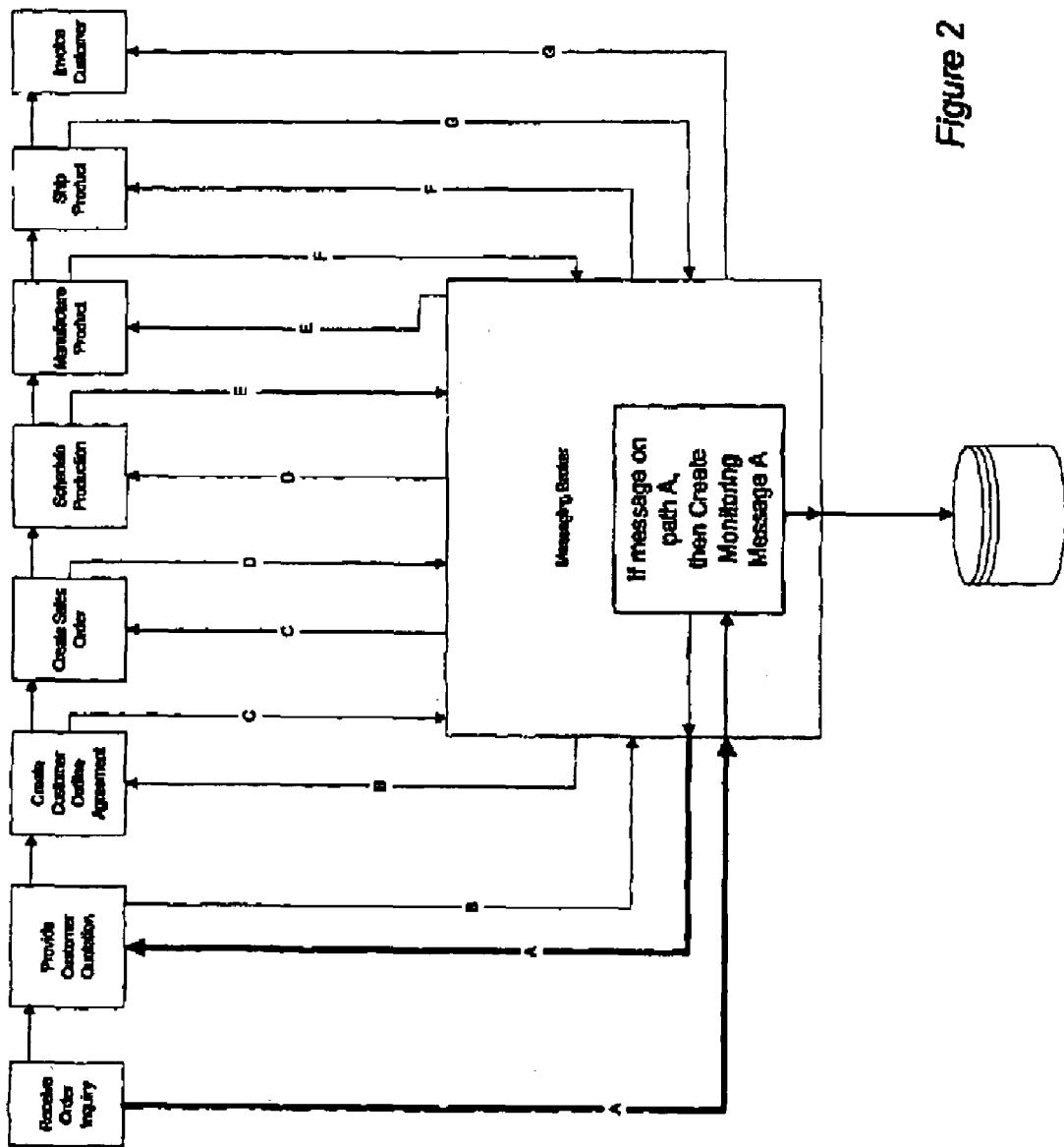

Figure 2

U.S. Patent

Jun. 13, 2006

Sheet 3 of 8

US 7,062,749 B2

Summary Of Orders

Your Information

Customer Number	Company	Location
5000	Dow Chemical	Midland, MI

Current Orders, Quotes, and Inquiries

Click on an order to view its detailed steps and history

Date	Transaction ID	Order Number	Current Status
3/27/2000	0003	800000	INVOICE
3/28/2000	2102	838400	MANUFACTURE
3/31/2000	2204	940302	ORDER

Figure 3

Order History and Tracking Information

Input: name=00000000 at 10:11

Your Information

Customer Number	Company	Location
0000	00000000	000000, 00

Current Order Status: Transaction 0000Order 000000

INVOICE

Invoice Date: 200606

Order Date:

Material Name	Material Number	Unit of Measure	Quantity	Price	Cost
Widget	000000	BOX	1		2.00

DETAILS

SECRET

? Date	Time	Order Number
200606	21:00	000000

QUOTE

Q Date	Time	Order Number
200606	00:00	

AGREEMENT

A Date	Time	Order Number
200606	00:00	

ORDER

O Date	Time	Order Number
200606	00:00	000000

SCHEDULE

S Date	Time	Order Number
200606	00:00	

MANUFACTURE

Date	Time	Production Number	Production Location	Status
200606	10:00	000000	LOC01	000

SHIP

Date	Time	Shipping Method	Tracking Number
200606	00:00	UPS	0000000000

INVOICE

Date	Time	Order Number
200606	00:00	000000

Figure 4

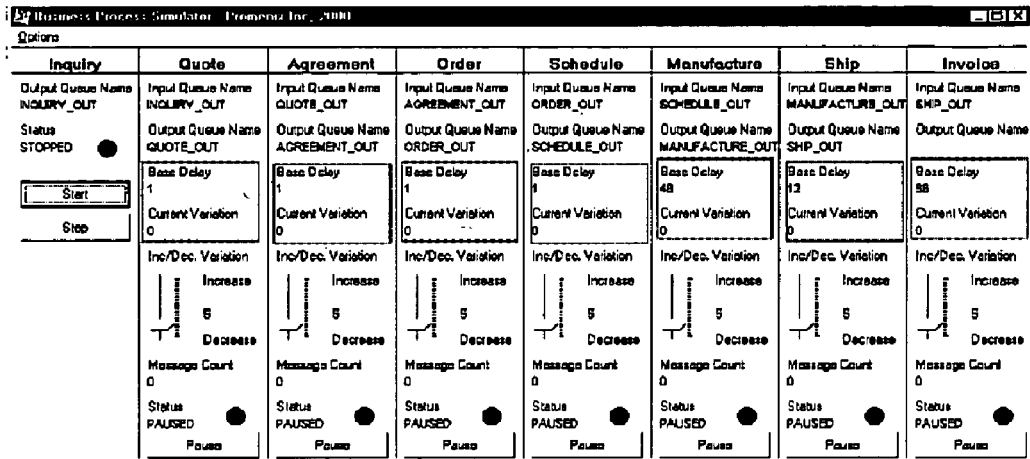

Figure 5

Process	Queues	Applica...	Data P...
Process Name	Order_to_cash	▲▼	▲▼
Sub-process	Agreement	▲▼	▲▼
Application	SAP R/3	▲▼	▲▼

Figure 6

Queues	Process	Applica...	Data P...
Queue Mgr.	QUEMGR1	▲▼	▲▼
Input Queue	INPTQ	▲▼	▲▼
Output Queue	OUPTQ	▲▼	▲▼

Figure 7

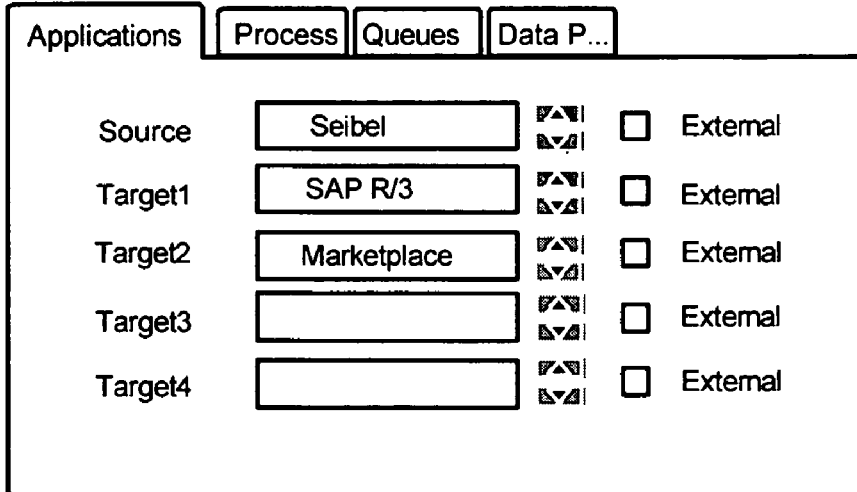

Figure 8

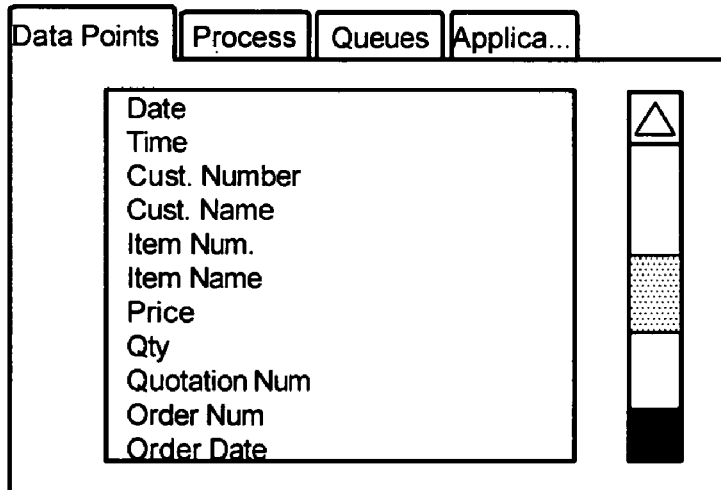

Figure 9

Process

Process Name	Order_to_cash	▼▲
Sub-process	Agreement	▼▲
Application	SAP R/3	▼▲

Figure 10

US 7,062,749 B2

1

MEASURING, MONITORING AND TRACKING ENTERPRISE COMMUNICATIONS AND PROCESSES

The present invention relates to apparatus and systems for measuring, monitoring, tracking and simulating enterprise communications and processes. More particularly, the present invention relates to computer-based apparatus and systems for measuring, monitoring, tracking and simulating enterprise communications and processes in an asynchronous messaging environment.

BACKGROUND OF THE INVENTION

The activities of a business or enterprise can be grouped into processes. Processes are business operations that are separated as desired and usually occur across business units. For example, the process of taking orders and turning those orders into revenue may be known as Order to Cash. The processes are comprised of sub-processes. For example, Order to Cash may be broken down into sub-processes such as Receive Order Inquiry, Provide Customer Quotation, Create Customer Outline Agreement, Create Sales Order, Schedule Production, Manufacture Product, Ship Product and Invoice Customer. Each sub-process may in turn be broken down into discrete activities such as providing customer number, entering that customer number, establishing pricing, determining a shipping date, etc.

The processes, sub-processes and activities operate, in part, by communicating information. For example, users may communicate through email. As another example, applications may communicate amongst themselves through electronic data interchange ("EDI") and other similar services. Communication occurs horizontally, that is, among a process, sub-process and activities, as well as vertically, that is, between processes, sub-processes and activities.

Whether communications occur horizontally or vertically, among applications or users, communications are increasingly asynchronous or message based. That is, enterprise communications were formerly primarily synchronous, or connection oriented, in which a connection is established with prior coordination between communication end points with data then being transmitted over the connection. Enterprise communications are now increasingly asynchronous, or connectionless, transmitting data without prior coordination between communication end points, such as through "event based" communications which use messages to move data instead of large files.

Asynchronous or message based communications permit loosely coupled connections among and between systems because the end points do not have to be prepared to receive the data when the message is transmitted. Loosely coupled connections permit more flexibility in assembling processes. Flexibility in assembling processes is desirable in order to permit quick reaction to changing business conditions: if a particular sub-process or activity becomes unusable, the process can be reassembled with a new sub-process or activity. For example, if a Manufacture Product sub-process in the Order to Cash process at Widget Co. enterprise has a specific factory identified to manufacture the product and that factory has a fire or other disaster, making it unusable, Widget Co. will need to substitute a new factory. The ripple effect of that substitution among all of Widget Co.'s processes will change any number of parameters. A loosely coupled asynchronous connection among Widget Co.'s processes provides rapid substitution of the new factory for the old because the end points of communication to the new

2

factory do not have to be predetermined before communications begin with the new factory. Thus, the flexibility of the asynchronous message based communication has permitted quick response to changing business conditions.

Despite this flexibility, asynchronous or message based communications are problematic because of their loosely coupled nature. At any given time, precise information on the progress of the processes is difficult to obtain—messages may be in transit and not instantly locatable. For example, if a customer calls for the status of an order, an enterprise customer service representative may be able to determine nothing more than the fact that the order has been received and that the scheduled ship date is X. There is often no ability to drill down into the information levels and review the status in more granularity, such as the location of the good, the manufacturing status, etc., because the information required to review that status is in transit and unable to be reviewed.

Of course, if the enterprise lacks the ability to access status information, business partners of the enterprise will similarly lack that ability. Thus, asynchronous communications may well increase inefficiency among business partners as well.

The difficulty in reporting caused by message based architecture also makes it difficult for the enterprise to measure the efficiency of its processes and their sub-process. Asynchronous messaging, with its indeterminate transmission of information, means a company may not be able to easily measure the interval between each sub-process, e.g. the time between Scheduling Production and the Manufacturing of a Product, and so easily measure the efficiency of their operations.

Finally, asynchronous messaging may provide an enterprise with an ability to model and simulate processes. That is, since information flows can be readily estimated through enterprises with asynchronous messaging, and processes can be easily modeled from those flows, asynchronous messaging modeling provides the potential to model and simulate processes. That potential is not realized with present technology, however. Moreover, since as described above, enterprises lack information on the processes they have implemented, the enterprises are handicapped in their ability to modify those processes or plan new processes. A modeling and simulation tool, demonstrating processes, sub-processes and their activity or granular detail level would be extremely helpful, and would give the enterprise an opportunity to assemble, test, adjust, and simulate processes and their details.

Accordingly, it is an object of the present invention to provide a tool for simulating message based architectures.

It is a further object of the present invention to provide monitoring capabilities for enterprise processes.

BRIEF DESCRIPTION OF THE DRAWINGS

FIG. 1 shows a view of a process.

FIG. 2 shows a view of a process of a preferred embodiment.

FIG. 3 shows a screen of a preferred embodiment.

FIG. 4 shows a screen of a preferred embodiment.

FIG. 5 shows a screen of a preferred embodiment.

FIG. 6 shows a partial view of a preferred embodiment.

FIG. 7 shows a partial view of a preferred embodiment.

FIG. 8 shows a partial view of a preferred embodiment.

FIG. 9 shows a partial view of a preferred embodiment.

FIG. 10 shows a partial view of a preferred embodiment.

US 7,062,749 B2

3

SUMMARY OF THE INVENTION

The present invention comprises apparatus and systems for measuring, monitoring, tracking and simulating enterprise communications and processes in an asynchronous messaging environment. For each original message sent within a process, sub-process or activity, the preferred embodiments of the present invention send a separate monitoring message containing data from the central message repository or database. This data may include date, time, customer number, materials, quantity, amount, or other information, and be copied from the original message. Other embodiments may add data to the monitoring message aside from that contained in the original message.

This central message repository or database is comprised of information passing through the enterprise. In effect, the database provides a collection point or an "end point" for the asynchronous communications, and so allows the flexibility of asynchronous communications to be combined with the precision of synchronous communications. The database can be reviewed in any number of ways. For example, the database can be queried to obtain specific information about that particular order or customer or could be examined across larger time spans such as days, weeks, or months, to gauge trends or performance. Of course, some preferred embodiments may wish to create mirror databases or other databases that can be used in various ways.

An enterprise's information flow can also be readily modeled and simulated through creating new process, sub-process and/or activities or altering existing process, sub-process or activities. The information flows from those creations or alterations can be collected in one or more databases and examined as desired.

DETAILED DESCRIPTION OF THE PREFERRED EMBODIMENTS

FIG. 1 shows a sample process, Order to Cash, which is comprised of various sub-processes: Receive Order Inquiry, Provide Customer Quotation, Create Customer Outline Agreement, Create Sales Order, Schedule Production, Manufacture Product, Ship Product and Invoice Customer. The dashed line arrows connecting the sub-processes are the communication paths between the sub-processes. In the example shown in the figure, the sub-processes actually communicate through a messaging broker, such as an IBM MQSeries component, and the paths to and from the component are identified identically. This messaging broker permits certain sophisticated messaging uses, such as message queuing, some data translation, etc.

A messaging component is added to the messaging broker, through methods known in the art. This messaging component creates a "monitoring" message for each original message received by the broker. This monitoring message contains, in this embodiment, specific data generated from the original messages passing between the sub-processes. The monitoring message with its data is then sent from the messaging broker to a central database repository or database (the terms "repository" or "database" are used interchangeably throughout.)

The messaging component may be, in some embodiments, or may not be, in other embodiments, provided by the messaging broker. For example, IBM's MQSeries messaging broker provides a component that can be configured to perform a copying function for the messages it receives, and so create monitoring messages for the messages it receives.

4

The specific data contained in the monitoring messages (in this embodiment, generated from the original messages passing between the sub-processes) is organized into data fields. Those data fields are path specific in this embodiment. For example, assume a customer calls the enterprise (Widget Co.) whose process is shown in FIG. 1 and asks whether or not Widget Co. has a certain product (Type A Widgets.) That customer request will begin the Receive Order Inquiry sub-process which will end with the generation of a Receive Order Inquiry message traveling to the Provide Customer Quotation sub-process through the messaging broker component. When the messaging broker receives the message on Path A, it will create a monitoring message, and send the monitoring message to the central database repository, as shown in FIG. 2. In this embodiment, the data contained in the monitoring message is generated from the message on Path A. Other preferred embodiments may alter or add data to the monitoring messages aside from that contained in the original message.

The monitoring message contains, in this embodiment, specific data fields. (Of course, other embodiments may have different data fields.) Those data fields are:

FIELDS	IDENTIFIERS
PROCESS IDENTIFIER	ProID,
SUB-PROCESS IDENTIFIER	SbProID,
CUSTOMER NUMBER	Custno,
PART NUMBER	Partno,
QUANTITY	Qty,
DATE	Date,
TIME	Time

The first field, the PROCESS IDENTIFIER field, provides the identifier for the process, for example, the value "Order to Cash" because the monitoring message is being created within the Order to Cash process. The second field, the SUB-PROCESS IDENTIFIER field, provides the identifier for the sub-process, for example, the value "Inquiry" because the monitoring message is being created within the Inquiry sub-process. This embodiment prepopulates these PROCESS IDENTIFIER and SUB-PROCESS IDENTIFIER fields, with the appropriate values.

The CUSTOMER NUMBER field is assigned to the particular customer generating the inquiry. The PART NUMBER field is the identifier for the particular part and the QUANTITY for the particular quantity. DATE and TIME are the data and time the message is generated. Other message fields for other paths of this embodiment are shown in Table 1. Of course, some, all or none of these fields may be present in other embodiments, as well as other fields as desired. For example, one or more ACTIVITY IDENTIFIER fields may be present in monitoring messages in other embodiments.

The monitoring message data populates one information flow or transaction record ("transaction record.") As monitoring messages progress through any given process and/or sub-process, the transaction record is updated. Once the monitoring messages complete the transaction record, all of the information needed to measure that transaction through the process is contained in one record in the central message database. (Of course, if the monitoring messages do not fully populate the transaction record, e.g., the transaction is aborted in mid process, then these abandoned records may be made available as well with an indication that they were abandoned.)

US 7,062,749 B2

5

The central message database can be reviewed in any number of ways, in order to measure, monitor and track enterprise communications and processes, e.g., to provide information or generate reports. Using the central message database to provide information or generate reports “off loads” the information access or reporting processes from the applications that generate messages initially, e.g., sub-processes such as those seen in FIG. 1. This off loading relieves some of the monitoring pressure from the source applications so that, for example, any queries that might have been made to the source applications and interfere with or slow down the operation of the source applications can now be made through the central message database.

The information retrieved from the central message database may include, but is not limited to, information about any particular order or customer, information about process efficiency, “snapshot” or time slice information, information across time spans such as days, weeks, or months, information to gauge trends or performance, etc. Also, in some embodiments, a “real-time” tool may be used to track the progress of transaction records and/or processes and use distribution methods such as broadcasting, WAP, etc. to provide the information to users. For example, if a process such as pipeline capacity for oil and natural gas transmissions is implemented and monitored through an embodiment of the present invention, the central message database will constantly broadcast unused pipeline capacity, which information in turn can be used to sell, trade or barter that unused capacity. As another example, information about an enterprise’s processes can be made available over an intranet, extranet, the Internet, etc. to business partners or other entities. One example would be providing information to stock analysts so that they could track any particular enterprise’s productivity or other areas of interest. Another example would be providing information to actual or potential business partners to check production capacity, shipping capacity, or other areas of interest. In some embodiments, with regard to external entities, communication channels between the external entities and the enterprise might well be established, so that central message databases exist on both ends of the communication channel.

The central message database allows for broader analysis of trends that may include: time between sub-processes, variances by customer, variances by order amount, bottlenecks in the process, etc. For example, it would be possible to determine how many orders stood between Order and Invoice. This may allow for the acceleration of some orders so they could be booked by quarter close. For example, a vendor bottleneck may be identified in the course of review of the processes, sub-processes and/or activities. For example, seasonal variations in processes, sub-processes and/or activities may be identified as well.

Of course, some embodiments may create mirror databases and/or generate other databases that can be used by various entities. For example, an enterprise may create a number of central message databases which could track processes, sub-processes and/or activities in whole or part. These databases could also be combined as desired.

Monitoring message database(s) may be used, in some embodiments, in various ways, either in addition to or instead of central message database(s.) For example, a monitoring message database or a central message database may be used to generate messages and feedback to the processes, sub-processes, activities and/or applications, as well as to users and/or administrators (herein generally “users.”) Various messages transmitted from sub-process applications such as error messages would generate special

6

monitoring messages which would be added to a message monitoring database. Other events, exceptions, triggers and thresholds, could be tracked as well in various embodiments and be used to signal conditions, problems, etc. by various methods such as “flagged” or specially designated messages or other indicators.

Access to the database(s) is, in the preferred embodiments, on a secured or authorized basis, with different users obtaining different levels of access to the data in the database.

FIG. 3 shows a screen shot of an example of a preferred embodiment where access was made available to a customer over a corporate extranet. The screen shot is of a report, generated through an XML link to the central message database, of that particular customer’s orders. In the preferred embodiments, the customer has the option to “drill down” through this screen to other screens for further detail. So, for example, FIG. 4 shows a result of one such operation, where the customer had drilled down from the screen of FIG. 3. Of course, these records may vary depending on the status of the transaction, that is, whether the transaction is in the middle of the process, at the beginning of the process, etc. Furthermore, other reporting options may be seen depending on the embodiments. Additionally, in some embodiments the user may have the option to drill down further into or past these levels if desired.

The preferred embodiments of the present invention also provide a simulation module for business processes. The simulation module makes possible simulation of new processes, their sub-processes and the activities that make up the sub-processes. This provides the enterprise or other user with the opportunity to assemble, test, adjust, and simulate processes before they are integrated into the enterprise.

The simulation module of the preferred embodiments provides the ability to assemble simulated processes in two primary ways. The first primary way is through provision of a toolkit or palette of predetermined sub-processes to the user. The user can then choose from that palette of sub-processes to form a process for an organization, which is then used in the simulation as is explained in further detail below.

The second primary method of assembling processes is to provide the user with activities, which are the most granular construct of a sub-process. Additionally, more sophisticated users will be given the opportunity to assemble their own activities. Either or both options of this second primary method can be offered in various embodiments. Additionally, the first and second primary methods can be combined in certain embodiments as well.

The preferred embodiments permit use of discrete activities among sub-processes, perhaps in an object oriented format, in order to save time and increase productivity. These activities can then be connected to form one or more sub-processes, which in turn can be connected to form one or more processes. The ability to create additional sub-processes would allow for the company to add their unique sub-processes to the palette.

It should be noted that in other embodiments, the simulation module may be constructed in other ways. For example, preconfigured, industry-specific processes may be supplied that can be altered and/or provided with enterprise specifics.

The simulation model is contained, in the preferred embodiments, on a corporate intranet or extranet. The underlying assumption of the simulation model in the preferred embodiments is that the completion of each sub-process will generate a message. So, for example, if a process such as that

US 7,062,749 B2

7

of FIG. 1 is simulated, the completion of the first sub-process will generate a message to be sent to the next sub-process, the completion of the next sub-process will generate a message that will be sent to the next sub-process, and so on.

FIG. 5 shows a process development environment screen for an example process called "Order" of the simulation module. Sub-processes Inquiry, Quote, Agreement, Order, Schedule, Manufacture, Ship and Invoice have been joined together to comprise this process. The sub-processes, in this example, are predetermined and their activities are predetermined. The input and output queue names are identified where appropriate. For example, the output queue name in the Inquiry sub-process is INQUIRY_OUT. That output queue then feeds data into the input queue of the Quote sub-process. (These are analogous to Path A in FIG. 1.) The base delay provides the initial time of a sub-process. For example, the base delay for the Quote Sub-process is 1 or a time increment of 1. In contrast the Manufacture Sub-process base delay is 48, so that the time increment for the Manufacture Sub-process is 48. The Current Variation shows the Increase/Decrease Variation set by the slider, permitting an increase or decrease in the latency per process and thus permits the user to see the downstream effect of altering each sub-process time. (Other embodiments may use different apparatus and methods as known in the art to vary the latency of the sub-process.) In this example, the total time of the process is obtained by adding each base delay of each sub-process, however, each sub-process may not affect the other in a geometric or logarithmic progression. For example, varying the base delay by one time increment of the Quote sub-process may not lead to an exact one time increment variation in the Scheduling sub-process.

FIGS. 6 through 9 are examples of tools that are used in this embodiment to construct sub-process modules such as those used in FIG. 5. For example, FIG. 6 shows the properties of the Agreement sub-process module, which are the process, the sub-process and the application used in the sub-process. The process and sub-process are predetermined in this module. The user has the option of setting the application alternative of the sub-process to one or more predetermined alternatives. These alternatives would be used, for example, when a new application might be used to provide output from the sub-process.

FIG. 7 shows a message queue construction tool for the sub-process identified in FIG. 6. This tool, which may be another option combined with the process tool of FIG. 6 or some other tool in various embodiments, or may be stand-alone in other embodiments, provides the ability to select a queue manager (a process that manages different message queues in various machines or applications), input queue and output queue for the particular sub-process being simulated. Each of these options, queue manager, input queue and output queue, can be changed by using the arrows to access a drop-down menu of predetermined alternatives. Once the alternatives are chosen, the module can be saved. Of course, in other embodiments non-predetermined alternatives may be used.

FIG. 8 shows an application construction tool, which can be used to select the applications used on either end of the queue or path. Here, there are two separate targets, one external, with a single monitoring message being sent to a central message database, before the source message is split and sent to both target applications. FIG. 9 shows the particular data fields or points that may be captured in the monitoring message. These are selected by highlighting the preferred fields in this embodiment.

8

Other alternatives are possible for other embodiments of the simulation module. For example, the embodiments discussed above have some alternatives as predetermined, which makes the construction of sub-process modules more convenient. In other embodiments non-predetermined alternatives may be used. Moreover, any desired processes that are not defined in predetermined modules can be developed and made available to the user. For example, a tool such as that shown in FIG. 10 provides the ability to alter the process, the sub-process, and the application, by using the arrows to access a drop-down menu of predetermined alternatives, thus facilitating creation of new processes, sub-processes and/or activities. Other embodiments may use an "open ended" format to allow the creation of new processes and sub-processes and/or activities.

The simulation module is, in the preferred embodiments, either stand-alone or contained as part of a monitoring apparatus and/or system as had been described above. If the latter, then "real-time" data and processes, sub-processes and activities can be used in the simulation apparatus and/or process. The simulator module permits processes and sub-processes to be defined, simulated, and refined before modifying existent systems or implementing new systems.

The above description and the views and material depicted by the figures are for purposes of illustration only and are not intended to be, and should not be construed as, limitations on the invention.

Moreover, certain modifications or alternatives may suggest themselves to those skilled in the art upon reading of this specification, all of which are intended to be within the spirit and scope of the present invention as defined in the attached claims.

TABLE 1

PATH	FIELDS	IDENTIFIERS
B	PROCESS IDENTIFIER SUBPROCESS IDENTIFIER CUSTOMER NUMBER MATTER NUMBER QUOTE NUMBER QUANTITY PRICE AMOUNT DATE TIME	Order to cash, quote, custno, matno, quote num, qty, price, amt, date, time
C	PROCESS IDENTIFIER SUBPROCESS IDENTIFIER CUSTOMER NUMBER MATTER NUMBER QUOTE NUMBER QUANTITY PRICE AMOUNT DATE TIME	Order to cash, Agreement, custno, matno, quote num, qty, price, amt, date, time
D	PROCESS IDENTIFIER SUBPROCESS IDENTIFIER ORDER NUMBER QUOTE NUMBER CUSTOMER NUMBER MATTER NUMBER QUANTITY PRICE AMOUNT DATE TIME	Order to cash, order, ordernum, quote num, custno, matno, qty, price, amt, date, time
E	PROCESS IDENTIFIER SUBPROCESS IDENTIFIER ORDER NUMBER QUOTE NUMBER PRODUCTION NUMBER PRODUCTION DATE	Order to cash, schedule, ordernum, quote num, production Number, Production date,

TABLE 1-continued

PATH	FIELDS	IDENTIFIERS
	PRODUCTION LOCATION	production location,
	PRODUCTION STATUS	production status,
	CUSTOMER NUMBER	custno,
	MATTER NUMBER	matno,
	QUANTITY	qty,
	PRICE	price,
	AMOUNT	amt,
	DATE	date,
	TIME	time
F	PROCESS IDENTIFIER	Order to cash,
	SUBPROCESS IDENTIFIER	mfg,
	ORDER NUMBER	ordernum,
	QUOTE NUMBER	quote num,
	PRODUCTION NUMBER	production Number,
	PRODUCTION DATE	Production date,
	PRODUCTION LOCATION	Production location,
	PRODUCTION STATUS	Production status,
	CUSTOMER NUMBER	custno,
	MATTER NUMBER	matno,
	QUANTITY	qty,
	PRICE	price,
	AMOUNT	amt,
	DATE	date,
	TIME	time
G	PROCESS IDENTIFIER	Order to cash,
	SUBPROCESS IDENTIFIER	ship,
	ORDER NUMBER	ordernum,
	QUOTE NUMBER	quote num,
	PRODUCTION NUMBER	production Number,
	PRODUCTION DATE	Production date,
	PRODUCTION LOCATION	production location,
	PRODUCTION STATUS	production status,
	CUSTOMER NUMBER	custno,
	SHIPPING DATE	ship date,
	MATTER NUMBER	matno,
	QUANTITY	qty,
	PRICE	price,
	AMOUNT	amt,
	DATE	date,
	TIME	time
H	PROCESS IDENTIFIER	Order to cash,
	SUBPROCESS IDENTIFIER	invoice,
	ORDER NUMBER	ordernum,
	QUOTE NUMBER	quote num,
	CUSTOMER NUMBER	custno,
	SHIPPING DATE	ship date,
	MATTER NUMBER	matno,
	QUANTITY	qty,
	PRICE	price,
	AMOUNT	amt,
	DATE	date,
	TIME	time

We claim:

1. A computerized method for use in an asynchronous messaging environment, wherein said messaging environment comprises at least one original message comprised of original message data, comprising:
 - providing, through a monitoring message, at least part of said original message data to a central message repository;
 - populating a transaction record in said central message repository with said original message data provided by said monitoring message;
 - wherein said original message data comprises the status of an activity.
2. A method as in claim 1 further comprising reviewing data collected in said transaction record.
3. A method as in claim 1 wherein said original message data comprises at least one field of data selected from the group consisting of date data, time data, customer number data, materials data, quantity data and amount data.

4. A method as in claim 1 wherein said original message data comprises at least one field selected from the group consisting of PROCESS IDENTIFIER, SUB-PROCESS IDENTIFIER, ACTIVITY IDENTIFIER, CUSTOMER NUMBER, PART NUMBER, QUANTITY, DATE and TIME.
5. A method as in claim 1 wherein said original message data comprises at least one field selected from the group consisting of ProID, SbProID, Custno, Partno, Qty, Date and Time.
6. A method as in claim 1 further comprising providing the status of a process by providing access to said central message repository.
7. A method as in claim 1 further comprising adding, to said monitoring message, data other than said original message data.
8. A method as in claim 1 further comprising updating said transaction record.
9. A method as in claim 8 further comprising updating said transaction record by:
 - providing, through a second monitoring message, a second original message data to said transaction record; and,
 - populating said transaction record with said second original message data provided by said second monitoring message.
10. A method as in claim 1 further comprising completing a process.
11. A method as in claim 10 further comprising completing said transaction record.
12. A method as in claim 1 further comprising aborting a process.
13. A method as in claim 12 further comprising providing, in said transaction record, an indication that the record has been abandoned.
14. A central message repository created by the method of claim 1.
15. A transaction record created by the method of claim 1.
16. A method as in claim 1 wherein said status of a process is a simulated process.
17. A method as in claim 1 wherein said original message data is simulated original message data.
18. A method as in claim 1 further comprising providing the status of a sub process by providing access to said central message repository.
19. A method as in claim 1 further comprising providing the status of an activity by providing access to said central message repository.
20. A method as in claim 1 wherein said status of a sub process is a simulated process.
21. A method as in claim 1 wherein said status of an activity is a simulated process.
22. A computerized method for use in an asynchronous messaging environment, wherein said messaging environment comprises at least one original message comprised of original message data, comprising:
 - monitoring a process, which is comprised of at least a first and second sub process, by generating original message data from each of said first and second sub process;
 - transmitting said original message data from said first sub process, via a first monitoring message, to a central message repository;
 - storing said original message data from said first sub process, in a transaction record in said central message repository;

US 7,062,749 B2

11

transmitting said original message data from said second sub process, via a second monitoring message, to said central message repository; and, storing said original message data from said second sub process, in said transaction record in said central message repository; wherein said original message data comprises the status of said sub processes.

23. A method as in claim 22 further comprising determining the status of said process.

24. A method as in claim 22 wherein said original message data from each of said first and second sub processes comprises a sub process specific set of data.

25. A method as in claim 22 wherein said first monitoring message further comprises altered original message data.

26. A method as in claim 22 wherein said first monitoring message further comprises data added to said original message data.

27. A method as in claim 22 further comprising reviewing said central message repository.

28. A method as in claim 27 wherein reviewing said central message repository further comprises reviewing information from the group consisting of order information, customer information, process efficiency information, snapshot information, time slice information, daily information, weekly information, monthly information, trend information and performance information.

29. A method as in claim 22 further comprising distributing process progress information in real time.

30. A method as in claim 29 further comprising distributing said process progress information through broadcasting.

31. A method as in claim 29 further comprising distributing said process progress information through the Internet.

32. A method as in claim 29 further comprising distributing said process progress information through Wireless Application Protocol.

33. A method as in claim 29 further comprising distributing said process progress information through an intranet.

34. A method as in claim 29 further comprising distributing said process progress information through an extranet.

35. A method as in claim 22 further comprising analyzing said central message repository in order to determine a process trend.

36. A method as in claim 35 wherein said process trend is selected from the group consisting of: time between sub-processes, variances by customer, variances by order amount, bottlenecks and seasonal variations.

37. A method as in claim 36 wherein orders may be accelerated as a result of said analysis.

38. A method as in claim 22 further comprising providing a monitoring message database.

39. A method as in claim 22 further comprising providing a report via an XML link to said central message repository.

40. A method as in claim 22 wherein said second monitoring message further comprises altered original message data.

41. A method as in claim 22 wherein said second monitoring message further comprises date added to said original message data.

42. An apparatus for use in an asynchronous messaging environment, wherein said messaging environment comprises at least one original message comprised of original message data, comprising:

means for providing, through a monitoring message, at least part of said original message data to a central message repository;

12

means for populating a transaction record in said central message repository with said original message data provided by said monitoring message; wherein said original message data comprises the status of a.

43. An apparatus as in claim 42 further comprising means for reviewing data collected in said transaction record.

44. An apparatus as in claim 42 further comprising means for broadcasting data collected in said transaction record.

45. An apparatus as in claim 42 further comprising means for providing the status of a process by providing access to said central message repository.

46. An apparatus as in claim 42 further comprising means for adding, to said monitoring message, data other than said original message data.

47. An apparatus as in claim 42 further comprising means for providing the status of a sub process by providing access to said central message repository.

48. An apparatus as in claim 42 further comprising means for providing the status of an activity by providing access to said central message repository.

49. An apparatus for use in an asynchronous messaging environment, wherein said messaging environment comprises at least one original message comprised of original message data, comprising:

means for monitoring a process, which is comprised of at least a first and second sub process, by generating original message data from each of said first and second sub process;

means for transmitting said original message data from said first sub process, via a first monitoring message, to a central message repository;

means for storing said original message data from said first sub process, in a transaction record in said central message repository;

means for transmitting said original message data from said second sub process, via a second monitoring message, to said central message repository; and,

means for storing said original message data from said second sub process, in said transaction record in said central message repository;

wherein said original message data comprises the status of said sub processes.

50. An apparatus as in claim 49 further comprising means for reviewing said central message repository.

51. An apparatus as in claim 49 further comprising means for distributing process progress information through broadcasting.

52. An apparatus as in claim 49 further comprising means for providing a monitoring message database.

53. An apparatus as in claim 49 further comprising means for providing a report via an XML link to said central message repository.

54. An apparatus as in claim 49 further comprising means for distributing said process progress information through Wireless Application Protocol.

55. A computerized method for use in an asynchronous messaging environment, wherein said messaging environment comprises at least one original message comprised of original message data, comprising:

providing, through a monitoring message, at least part of said original message data to a central message repository;

populating a transaction record in said central message repository with said original message data provided by said monitoring message;

US 7,062,749 B2

13

wherein said original message data comprises the status of a process.

56. A computerized method for use in an asynchronous messaging environment, wherein said messaging environment comprises at least one original message comprised of original message data, comprising: 5

providing, through a monitoring message, at least part of said original message data to a central message repository;

populating a transaction record in said central message repository with said original message data provided by said monitoring message; 10

wherein said original message data comprises the status of a sub process.

57. An apparatus for use in an asynchronous messaging environment, wherein said messaging environment comprises at least one original message comprised of original message data, comprising: 15

means for providing, through a monitoring message, at least part of said original message data to a central message repository; 20

14

means for populating a transaction record in said central message repository with said original message data provided by said monitoring message;

wherein said original message data comprises the status of a sub process.

58. An apparatus for use in an asynchronous messaging environment, wherein said messaging environment comprises at least one original message comprised of original message data, comprising: 10

means for providing, through a monitoring message, at least part of said original message data to a central message repository;

means for populating a transaction record in said central message repository with said original message data provided by said monitoring message;

wherein said original message data comprises the status of an activity.

* * * * *

EXHIBIT B

(12) **United States Patent**
Cyr et al.

(10) **Patent No.:** **US 7,603,674 B2**
 (45) **Date of Patent:** ***Oct. 13, 2009**

(54) **APPARATUS AND SYSTEMS FOR MEASURING, MONITORING, TRACKING AND SIMULATING ENTERPRISE COMMUNICATIONS AND PROCESSES**

(75) Inventors: **Vincent R. Cyr**, Glen Mills, PA (US);
Kenneth Fritz, Glen Mills, PA (US)

(73) Assignee: **YYZ, LLC**

(*) Notice: Subject to any disclaimer, the term of this patent is extended or adjusted under 35 U.S.C. 154(b) by 272 days.

This patent is subject to a terminal disclaimer.

(21) Appl. No.: **11/398,133**

(22) Filed: **Apr. 5, 2006**

(65) **Prior Publication Data**

US 2006/0200804 A1 Sep. 7, 2006

Related U.S. Application Data

(63) Continuation of application No. 09/737,494, filed on Dec. 15, 2000, now Pat. No. 7,062,749.

(51) **Int. Cl.**
G06F 13/00 (2006.01)

(52) **U.S. Cl.** **719/313; 709/217; 707/1; 707/10**

(58) **Field of Classification Search** **717/103; 705/9; 709/231, 227, 202, 206, 217; 719/314, 719/315, 316, 313; 707/3, 10, 1**
 See application file for complete search history.

(56) **References Cited**

U.S. PATENT DOCUMENTS

- 5,404,501 A 4/1995 Carr et al.
- 5,887,167 A 3/1999 Sutton
- 5,949,998 A 9/1999 Fowlow et al.
- 5,960,200 A 9/1999 Eager et al.

- 6,018,627 A 1/2000 Iyengar et al.
- 6,041,306 A 3/2000 Du et al.
- 6,065,009 A 5/2000 Leymann et al.
- 6,092,102 A 7/2000 Wagner
- 6,122,633 A 9/2000 Leymann et al.
- 6,278,977 B1 8/2001 Agrawal et al.
- 6,405,266 B1 * 6/2002 Bass et al. 719/328
- 6,415,297 B1 7/2002 Leymann et al.
- 6,445,774 B1 * 9/2002 Kidder et al. 379/9.03
- 6,460,175 B1 10/2002 Ferri et al.
- 6,466,935 B1 10/2002 Stuart
- 6,487,548 B1 * 11/2002 Leymann et al. 707/3
- 6,501,950 B1 12/2002 Smith et al.
- 6,510,429 B1 1/2003 Todd
- 6,529,932 B1 3/2003 Dadiomov et al.
- 6,543,047 B1 4/2003 Vrhel et al.

(Continued)

OTHER PUBLICATIONS

"A Performance Study of Client-Broker-Server Systems", Omotunde Adebayo et al, ACM, Nov. 1997, pp. 1-15.*

(Continued)

Primary Examiner—Andy Ho

(57) **ABSTRACT**

The present invention comprises apparatus and systems for measuring, monitoring, tracking and simulating enterprise communications and processes. A central message repository or database is constructed, comprised of monitoring messages sent from process messaging systems. The database may then be accessed or queried as desired. A simulation tool assists in reviewing present and proposed processes and sub-processes before modifying existent systems or creating new systems.

173 Claims, 6 Drawing Sheets

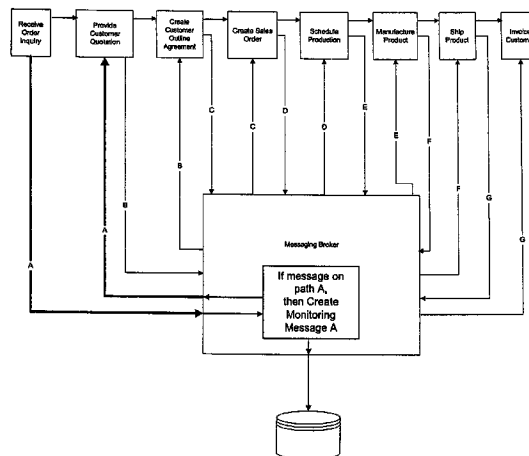

US 7,603,674 B2

Page 2

U.S. PATENT DOCUMENTS

6,553,438 B1 4/2003 Coffman et al.
 6,601,233 B1 7/2003 Underwood
 6,662,355 B1 12/2003 Caswell et al.
 6,671,728 B1* 12/2003 Mayberry 709/227
 6,681,245 B1 1/2004 Sasagawa
 6,725,445 B1 4/2004 Leymann et al.
 6,728,947 B1 4/2004 Bengston
 6,757,710 B2 6/2004 Reed
 6,789,252 B1 9/2004 Burke et al.
 6,901,430 B1 5/2005 Smith
 6,943,681 B2 9/2005 Rezvani et al.
 7,057,752 B1* 6/2006 Klotz, Jr. 358/1.15

OTHER PUBLICATIONS

“A Publish/Subscribe CORBA Persistent State Service Prototype”,
 ACM, Apr. 2000, pp. 231-255.*
 Adaptive Plug-andPlay Components for Evolutionary Software
 Development, Mira Mezini et al, ACM, 1998, pp. 97-116.*
 Wide Workflow Development Methodology, L. Baresi et al, ACM,
 Mar. 1999, pp. 19-28.*
 “Implementing SAP R/3 How to Introduce a Large System into a
 Large Organization,” pp. 1-73, N.H. Bancroft et al., 1997.
 “SAP An Executive Comprehensive Guide,” Grant Norris et al., pp.
 1-13, 1998.
 Windows NT Server Operating System, Microsoft Message Queuing
 Services, Microsoft, 1997, pp. 1-38.

Messaging & Queuing Using the MQI, burnie Blakey et al., Jun. 26,
 1995, Whole Book.
 Building Distributed Applications with Message Queing
 Middleware, Peter Houston, Microsoft Corp., Mar. 1998, 7 pages.
 “Special Issue on TP Monitors and Distributed Transaction Manage-
 ment,” Ron Obermarck et al., Data Engineering, Mar. 1994, vol. 17,
 No. 1, IEEE Computer Society, 32 pages.
 “Remote Queues: Exposing Message Queues for Optimization and
 Atomicity,” E.A. Brewer et al., MCM, 1995, pp. 42-53.
 Cummings, Enterprise Integration with Workflow Management,
 Nov. 1, 1999.
 Ebbers, et al, Image and Workflow Library, Apr. 1999.
 Van De Putte, et al, Business Integration Solutions with MQ Series
 Intergrator, Aug. 2000.
 Stegmaier, et al, Image and Workflow Library, Feb. 1998.
 Eller, et al, Image and Workflow Library, Oct. 1997.
 Van Den Enden, et al, A Case Study in Application Integration, Oct.
 16, 2000.
 Cummings, Enterprise Integration with Asynchronous Messaging
 Services, Oct. 6, 1999.
 IBM, Software Announcement MQSeries Workflow 3.2. Adds Sup-
 port for e-business and New Platforms, Jun. 15, 1999.
 Leymann, et al, Production Workflow, excerpts, 2000.
 Alonso, et al, Exotica/FMQM, Aug. 1995.
 Alonso, et al, Distributed Data Management, 1997.

* cited by examiner

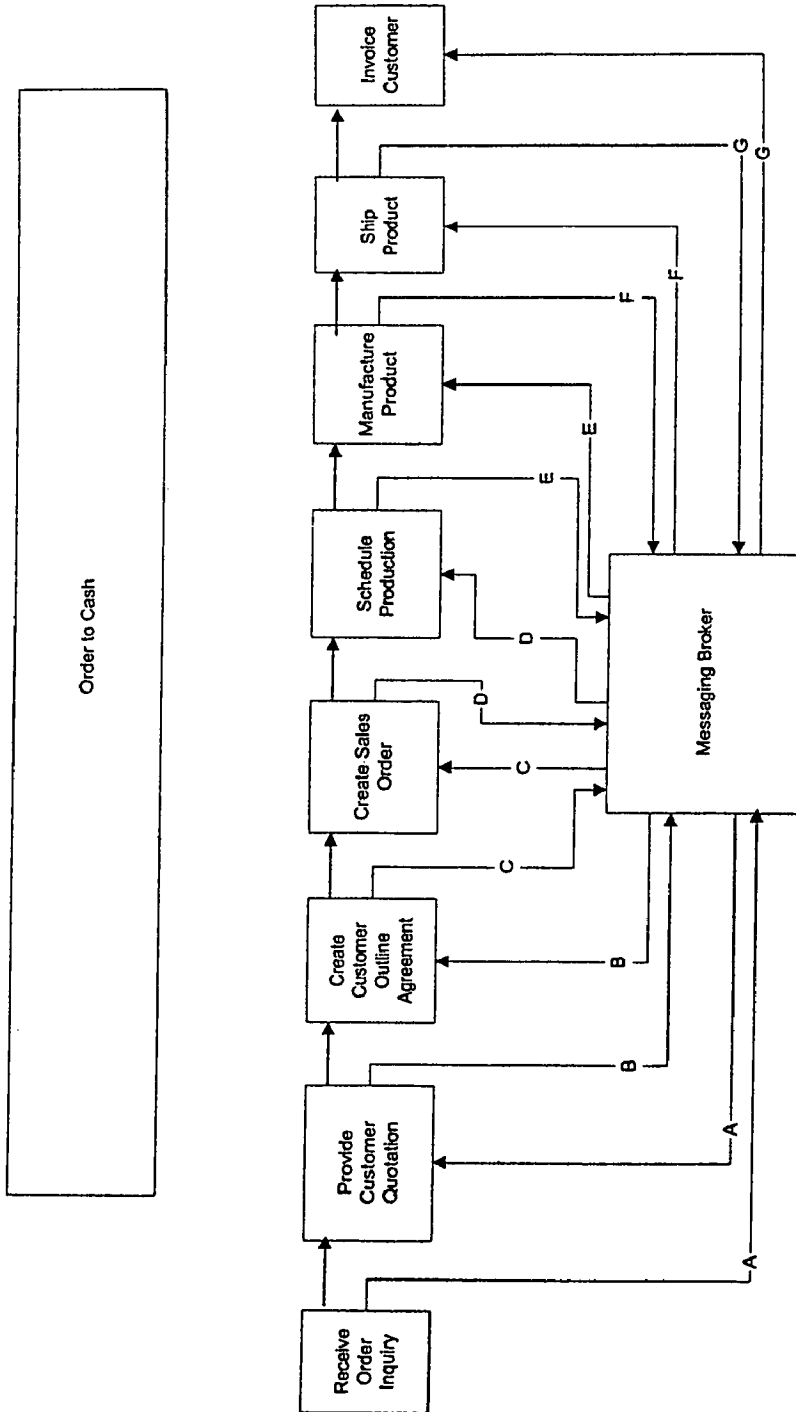

Figure 1

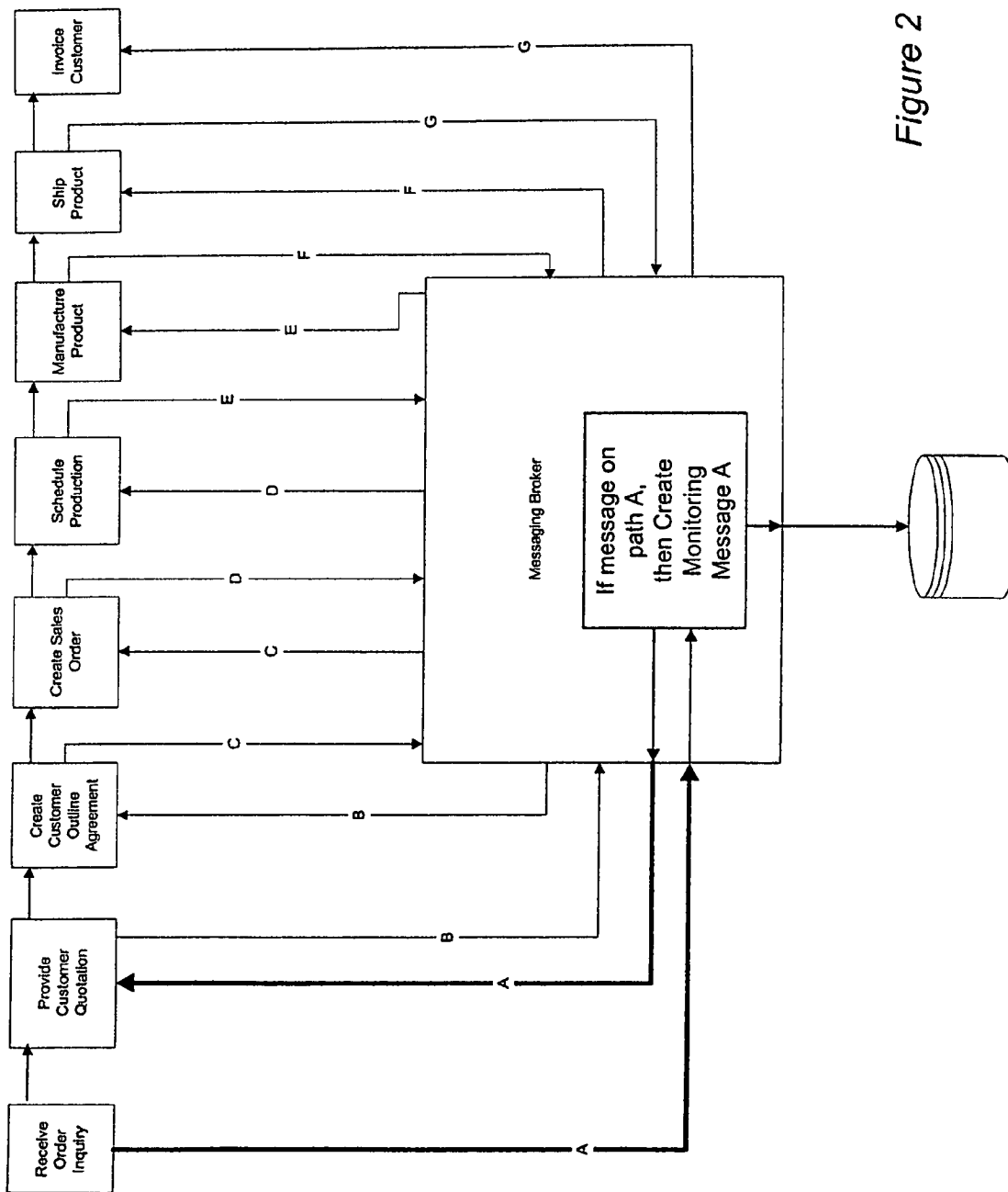

Figure 2

U.S. Patent

Oct. 13, 2009

Sheet 3 of 6

US 7,603,674 B2

Summary Of Orders

Your Information

Customer Number	Company	Location
5000	Dow Chemical	Midland, MI

Current Orders, Quotes, and Inquiries

Click on an order to view its detailed status and history

Date	Transaction ID	Order Number	Current Status
3/27/2000	<u>0003</u>	800000	INVOICE
3/29/2000	2102	839400	MANUFACTURE
3/31/2000	2204	940302	ORDER

Figure 3

Order History and Tracking Information

Inquiry created 04/18/2000 at 10:18

Your Information

Customer Number	Company	Location
5000	Dow Chemical	Midland, MI

Current Order Status - Transaction 003/Order 800000

 **INVOICE**

Invoice Date: 3/31/00

Order Detail

Material Name	Material Number	Unit of Measure	Quantity	Price Each
Widget	800003	BOX	2	2.00

Order History









INQUIRY					
	Date	Time	Quote Number		
	3/28/2000	21:00	200001		
QUOTE					
	Date	Time			
	3/28/2000	22:15			
AGREEMENT					
	Date	Time			
	3/27/2000	08:15			
ORDER					
	Date	Time	Order Number		
	3/27/2000	09:00	800000		
SCHEDULE					
	Date	Time			
	3/27/2000	12:00			
MANUFACTURE					
	Date	Time	Production Number	Production Location	Status
	3/29/2000	11:34	410000	LOCAL	NA
SHIP					
	Date	Time	Shipping Method	Tracking Number	
	3/31/2000	21:00	UPS	1Z4505646909G	
INVOICE					
	Date	Time	Order Number		
	3/31/2000	21:00	800000		

Figure 4

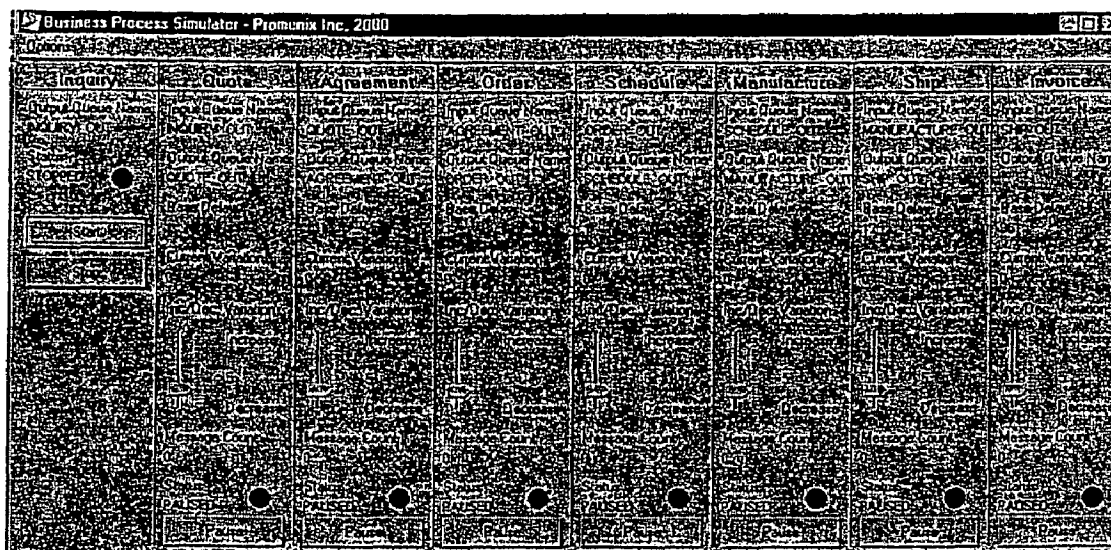

Figure 5

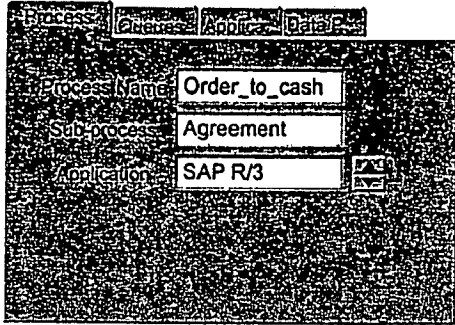

Figure 6

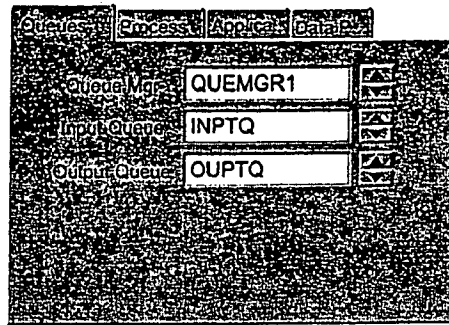

Figure 7

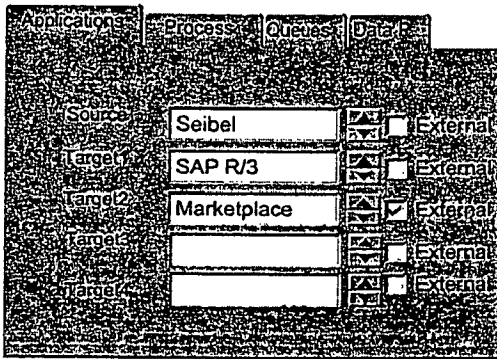

Figure 8

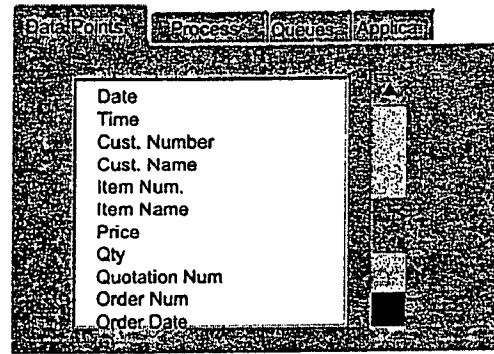

Figure 9

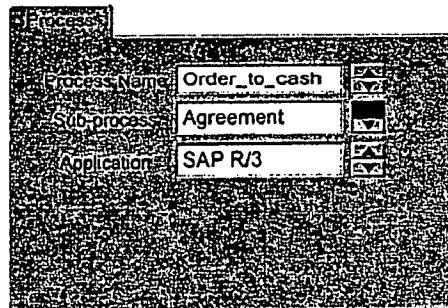

Figure 10

US 7,603,674 B2

1

**APPARATUS AND SYSTEMS FOR
MEASURING, MONITORING, TRACKING
AND SIMULATING ENTERPRISE
COMMUNICATIONS AND PROCESSES**

CROSS REFERENCE TO RELATED
APPLICATION

This application is a continuation of and claims the benefit of U.S. patent application Ser. No. 09/737,494 filed Dec. 15, 2000, entitled Apparatus and Methods for Isolating and Reviewing Data from Multiple Sources, now issued U.S. Pat. No. 7,062,749.

The present invention relates to apparatus and systems for measuring, monitoring, tracking and simulating enterprise communications and processes. More particularly, the present invention relates to computer-based apparatus and systems for measuring, monitoring, tracking and simulating enterprise communications and processes in an asynchronous messaging environment.

BACKGROUND OF THE INVENTION

The activities of a business or enterprise can be grouped into processes. Processes are business operations that are separated as desired and usually occur across business units. For example, the process of taking orders and turning those orders into revenue may be known as Order to Cash. The processes are comprised of sub-processes. For example, Order to Cash may be broken down into sub-processes such as Receive Order Inquiry, Provide Customer Quotation, Create Customer Outline Agreement, Create Sales Order, Schedule Production, Manufacture Product, Ship Product and Invoice Customer. Each sub-process may in turn be broken down into discrete activities such as providing customer number, entering that customer number, establishing pricing, determining a shipping date, etc.

The processes, sub-processes and activities operate, in part, by communicating information. For example, users may communicate through email. As another example, applications may communicate amongst themselves through electronic data interchange ("EDI") and other similar services. Communication occurs horizontally, that is, among a process, sub-process and activities, as well as vertically, that is, between processes, sub-processes and activities.

Whether communications occur horizontally or vertically, among applications or users, communications are increasingly asynchronous or message based. That is, enterprise communications were formerly primarily synchronous, or connection oriented, in which a connection is established with prior coordination between communication end points with data then being transmitted over the connection. Enterprise communications are now increasingly asynchronous, or connectionless, transmitting data without prior coordination between communication end points, such as through "event based" communications which use messages to move data instead of large files.

Asynchronous or message based communications permit loosely coupled connections among and between systems because the end points do not have to be prepared to receive the data when the message is transmitted. Loosely coupled connections permit more flexibility in assembling processes. Flexibility in assembling processes is desirable in order to permit quick reaction to changing business conditions: if a particular sub-process or activity becomes unusable, the process can be reassembled with a new sub-process or activity. For example, if a Manufacture Product sub-process in the

2

Order to Cash process at Widget Co. enterprise has a specific factory identified to manufacture the product and that factory has a fire or other disaster, making it unusable, Widget Co. will need to substitute a new factory. The ripple effect of that substitution among all of Widget Co.'s processes will change any number of parameters. A loosely coupled asynchronous connection among Widget Co.'s processes provides rapid substitution of the new factory for the old because the end points of communication to the new factory do not have to be predetermined before communications begin with the new factory. Thus, the flexibility of the asynchronous message based communication has permitted quick response to changing business conditions.

Despite this flexibility, asynchronous or message based communications are problematic because of their loosely coupled nature. At any given time, precise information on the progress of the processes is difficult to obtain—messages may be in transit and not instantly locatable. For example, if a customer calls for the status of an order, an enterprise customer service representative may be able to determine nothing more than the fact that the order has been received and that the scheduled ship date is X. There is often no ability to drill down into the information levels and review the status in more granularity, such as the location of the good, the manufacturing status, etc., because the information required to review that status is in transit and unable to be reviewed.

Of course, if the enterprise lacks the ability to access status information, business partners of the enterprise will similarly lack that ability. Thus, asynchronous communications may well increase inefficiency among business partners as well.

The difficulty in reporting caused by message based architecture also makes it difficult for the enterprise to measure the efficiency of its processes and their sub-process. Asynchronous messaging, with its indeterminate transmission of information, means a company may not be able to easily measure the interval between each sub-process, e.g. the time between Scheduling Production and the Manufacturing of a Product, and so easily measure the efficiency of their operations.

Finally, asynchronous messaging may provide an enterprise with an ability to model and simulate processes. That is, since information flows can be readily estimated through enterprises with asynchronous messaging, and processes can be easily modeled from those flows, asynchronous messaging modeling provides the potential to model and simulate processes. That potential is not realized with present technology, however. Moreover, since as described above, enterprises lack information on the processes they have implemented, the enterprises are handicapped in their ability to modify those processes or plan new processes. A modeling and simulation tool, demonstrating processes, sub-processes and their activity or granular detail level would be extremely helpful, and would give the enterprise an opportunity to assemble, test, adjust, and simulate processes and their details.

Accordingly, it is an object of the present invention to provide a tool for simulating message based architectures.

It is a further object of the present invention to provide monitoring capabilities for enterprise processes.

BRIEF DESCRIPTION OF THE DRAWINGS

- FIG. 1 shows a view of a process.
 FIG. 2 shows a view of a process of a preferred embodiment.
 FIG. 3 shows a screen of a preferred embodiment.
 FIG. 4 shows a screen of a preferred embodiment.
 FIG. 5 shows a screen of a preferred embodiment.
 FIG. 6 shows a partial view of a preferred embodiment.

US 7,603,674 B2

3

FIG. 7 shows a partial view of a preferred embodiment.
 FIG. 8 shows a partial view of a preferred embodiment.
 FIG. 9 shows a partial view of a preferred embodiment.
 FIG. 10 shows a partial view of a preferred embodiment.

SUMMARY OF THE INVENTION

The present invention comprises apparatus and systems for measuring, monitoring, tracking and simulating enterprise communications and processes in an asynchronous messaging environment. For each original message sent within a process, sub-process or activity, the preferred embodiments of the present invention send a separate monitoring message containing data from the central message repository or database. This data may include date, time, customer number, materials, quantity, amount, or other information, and be copied from the original message. Other embodiments may add data to the monitoring message aside from that contained in the original message.

This central message repository or database is comprised of information passing through the enterprise. In effect, the database provides a collection point or an "end point" for the asynchronous communications, and so allows the flexibility of asynchronous communications to be combined with the precision of synchronous communications. The database can be reviewed in any number of ways. For example, the database can be queried to obtain specific information about that particular order or customer or could be examined across larger time spans such as days, weeks, or months, to gauge trends or performance. Of course, some preferred embodiments may wish to create mirror databases or other databases that can be used in various ways.

An enterprise's information flow can also be readily modeled and simulated through creating new process, sub-process and/or activities or altering existing process, sub-process or activities. The information flows from those creations or alterations can be collected in one or more databases and examined as desired.

DETAILED DESCRIPTION OF THE PREFERRED EMBODIMENTS

FIG. 1 shows a sample process, Order to Cash, which is comprised of various sub-processes: Receive Order Inquiry, Provide Customer Quotation, Create Customer Outline Agreement, Create Sales Order, Schedule Production, Manufacture Product, Ship Product and Invoice Customer. The dashed line arrows connecting the sub-processes are the communication paths between the sub-processes. In the example shown in the figure, the sub-processes actually communicate through a messaging broker, such as an IBM MQSeries component, and the paths to and from the component are identified identically. This messaging broker permits certain sophisticated messaging uses, such as message queuing, some data translation, etc.

A messaging component is added to the messaging broker, through methods known in the art. This messaging component creates a "monitoring" message for each original message received by the broker. This monitoring message contains, in this embodiment, specific data generated from the original messages passing between the sub-processes. The monitoring message with its data is then sent from the messaging broker to a central database repository or database (the terms "repository" or "database" are used interchangeably throughout.)

The messaging component may be, in some embodiments, or may not be, in other embodiments, provided by the mes-

4

saging broker. For example, IBM's MQSeries messaging broker provides a component that can be configured to perform a copying function for the messages it receives, and so create monitoring messages for the messages it receives.

The specific data contained in the monitoring messages (in this embodiment, this data is copied from the original messages passing between the sub-processes) is organized into data fields. Those data fields are path specific in this embodiment. For example, assume a customer calls the enterprise (Widget Co.) whose process is shown in FIG. 1 and asks whether or not Widget Co. has a certain product (Type A Widgets.) That customer request will begin the Receive Order Inquiry sub-process which will end with the generation of a Receive Order Inquiry message traveling to the Provide Customer Quotation sub-process through the messaging broker component. When the messaging broker receives the message on Path A, it will create a monitoring message, and send the monitoring message to the central database repository, as shown in FIG. 2. In this embodiment, the data contained in the monitoring message is generated from the message on Path A. Other preferred embodiments may alter or add data to the monitoring messages aside from that contained in the original message.

The monitoring message contains, in this embodiment, specific data fields. (Of course, other embodiments may have different data fields.) Those data fields are:

FIELDS	IDENTIFIERS
PROCESS IDENTIFIER	ProID,
SUB-PROCESS IDENTIFIER	SbProID,
CUSTOMER NUMBER	Custno,
PART NUMBER	Partno,
QUANTITY	Qty,
DATE	Date,
TIME	Time

The first field, the PROCESS IDENTIFIER field, provides the identifier for the process, for example, the value "Order to Cash" because the monitoring message is being created within the Order to Cash process. The second field, the SUB-PROCESS IDENTIFIER field, provides the identifier for the sub-process, for example, the value "Inquiry" because the monitoring message is being created within the Inquiry sub-process. This embodiment prepopulates these PROCESS IDENTIFIER and SUB-PROCESS IDENTIFIER fields, with the appropriate values.

The CUSTOMER NUMBER field is assigned to the particular customer generating the inquiry. The PART NUMBER field is the identifier for the particular part and the QUANTITY for the particular quantity. DATE and TIME are the data and time the message is generated. Other message fields for other paths of this embodiment are shown in Table 1. Of course, some, all or none of these fields may be present in other embodiments, as well as other fields as desired. For example, one or more ACTIVITY IDENTIFIER fields may be present in monitoring messages in other embodiments.

The monitoring message data populates one information flow or transaction record ("transaction record.") As monitoring messages progress through any given process and/or sub-process, the transaction record is updated. Once the monitoring messages complete the transaction record, all of the information needed to measure that transaction through the process is contained in one record in the central message database. (Of course, if the monitoring messages do not fully populate the transaction record, e.g., the transaction is

US 7,603,674 B2

5

aborted in mid process, then these abandoned records may be made available as well with an indication that they were abandoned.)

The central message database can be reviewed in any number of ways, in order to measure, monitor and track enterprise communications and processes, e.g., to provide information or generate reports. Using the central message database to provide information or generate reports “off loads” the information access or reporting processes from the applications that generate messages initially, e.g., sub-processes such as those seen in FIG. 1. This off loading relieves some of the monitoring pressure from the source applications so that, for example, any queries that might have been made to the source applications and interfere with or slow down the operation of the source applications can now be made through the central message database.

The information retrieved from the central message database may include, but is not limited to, information about any particular order or customer, information about process efficiency, “snapshot” or time slice information, information across time spans such as days, weeks, or months, information to gauge trends or performance, etc. Also, in some embodiments, a “real-time” tool may be used to track the progress of transaction records and/or processes and use distribution methods such as broadcasting, WAP, etc. to provide the information to users. For example, if a process such as pipeline capacity for oil and natural gas transmissions is implemented and monitored through an embodiment of the present invention, the central message database will constantly broadcast unused pipeline capacity, which information in turn can be used to sell, trade or barter that unused capacity. As another example, information about an enterprise’s processes can be made available over an intranet, extranet, the Internet, etc. to business partners or other entities. One example would be providing information to stock analysts so that they could track any particular enterprise’s productivity or other areas of interest. Another example would be providing information to actual or potential business partners to check production capacity, shipping capacity, or other areas of interest. In some embodiments, with regard to external entities, communication channels between the external entities and the enterprise might well be established, so that central message databases exist on both ends of the communication channel.

The central message database allows for broader analysis of trends that may include: time between sub-processes, variances by customer, variances by order amount, bottlenecks in the process, etc. For example, it would be possible to determine how many orders stood between Order and Invoice. This may allow for the acceleration of some orders so they could be booked by quarter close. For example, a vendor bottleneck may be identified in the course of review of the processes, sub-processes and/or activities. For example, seasonal variations in processes, sub-processes and/or activities may be identified as well.

Of course, some embodiments may create mirror databases and/or generate other databases that can be used by various entities. For example, an enterprise may create a number of central message databases which could track processes, sub-processes and/or activities in whole or part. These databases could also be combined as desired.

Monitoring message database(s) may be used, in some embodiments, in various ways, either in addition to or instead of central message database(s.) For example, a monitoring message database or a central message database may be used to generate messages and feedback to the processes, sub-processes, activities and/or applications, as well as to users

6

and/or administrators (herein generally “users.”) Various messages transmitted from sub-process applications such as error messages would generate special monitoring messages which would be added to a message monitoring database. Other events, exceptions, triggers and thresholds, could be tracked as well in various embodiments and be used to signal conditions, problems, etc. by various methods such as “flagged” or specially designated messages or other indicators.

Access to the database(s) is, in the preferred embodiments, on a secured or authorized basis, with different users obtaining different levels of access to the data in the database.

FIG. 3 shows a screen shot of an example of a preferred embodiment where access was made available to a customer over a corporate extranet. The screen shot is of a report, generated through an XML link to the central message database, of that particular customer’s orders. In the preferred embodiments, the customer has the option to “drill down” through this screen to other screens for further detail. So, for example, FIG. 4 shows a result of one such operation, where the customer had drilled down from the screen of FIG. 3. Of course, these records may vary depending on the status of the transaction, that is, whether the transaction is in the middle of the process, at the beginning of the process, etc. Furthermore, other reporting options may be seen depending on the embodiments. Additionally, in some embodiments the user may have the option to drill down further into or past these levels if desired.

The preferred embodiments of the present invention also provide a simulation module for business processes. The simulation module makes possible simulation of new processes, their sub-processes and the activities that make up the sub-processes. This provides the enterprise or other user with the opportunity to assemble, test, adjust, and simulate processes before they are integrated into the enterprise.

The simulation module of the preferred embodiments provides the ability to assemble simulated processes in two primary ways. The first primary way is through provision of a toolkit or palette of predetermined sub-processes to the user. The user can then choose from that palette of sub-processes to form a process for an organization, which is then used in the simulation as is explained in further detail below.

The second primary method of assembling processes is to provide the user with activities, which are the most granular construct of a sub-process. Additionally, more sophisticated users will be given the opportunity to assemble their own activities. Either or both options of this second primary method can be offered in various embodiments. Additionally, the first and second primary methods can be combined in certain embodiments as well.

The preferred embodiments permit use of discrete activities among sub-processes, perhaps in an object oriented format, in order to save time and increase productivity. These activities can then be connected to form one or more sub-processes, which in turn can be connected to form one or more processes. The ability to create additional sub-processes would allow for the company to add their unique sub-processes to the palette.

It should be noted that in other embodiments, the simulation module may be constructed in other ways. For example, preconfigured, industry-specific processes may be supplied that can be altered and/or provided with enterprise specifics.

The simulation model is contained, in the preferred embodiments, on a corporate intranet or extranet. The underlying assumption of the simulation model in the preferred embodiments is that the completion of each sub-process will generate a message. So, for example, if a process such as that

US 7,603,674 B2

7

of FIG. 1 is simulated, the completion of the first sub-process will generate a message to be sent to the next sub-process, the completion of the next sub-process will generate a message that will be sent to the next sub-process, and so on.

FIG. 5 shows a process development environment screen for an example process called "Order" of the simulation module. Sub-processes Inquiry, Quote, Agreement, Order, Schedule, Manufacture, Ship and Invoice have been joined together to comprise this process. The sub-processes, in this example, are predetermined and their activities are predetermined. The input and output queue names are identified where appropriate. For example, the output queue name in the Inquiry sub-process is INQUIRY_OUT. That output queue then feeds data into the input queue of the Quote sub-process. (These are analogous to Path A in FIG. 1.) The base delay provides the initial time of a sub-process. For example, the base delay for the Quote Sub-process is 1 or a time increment of 1. In contrast the Manufacture Sub-process base delay is 48, so that the time increment for the Manufacture Sub-process is 48. The Current Variation shows the Increase/Decrease Variation set by the slider, permitting an increase or decrease in the latency per process and thus permits the user to see the downstream effect of altering each sub-process time. (Other embodiments may use different apparatus and methods as known in the art to vary the latency of the sub-process.) In this example, the total time of the process is obtained by adding each base delay of each sub-process, however, each sub-process may not affect the other in a geometric or logarithmic progression. For example, varying the base delay by one time increment of the Quote sub-process may not lead to an exact one time increment variation in the Scheduling sub-process.

FIGS. 6 through 9 are examples of tools that are used in this embodiment to construct sub-process modules such as those used in FIG. 5. For example, FIG. 6 shows the properties of the Agreement sub-process module, which are the process, the sub-process and the application used in the sub-process. The process and sub-process are predetermined in this module. The user has the option of setting the application alternative of the sub-process to one or more predetermined alternatives. These alternatives would be used, for example, when a new application might be used to provide output from the sub-process.

FIG. 7 shows a message queue construction tool for the sub-process identified in FIG. 6. This tool, which may be another option combined with the process tool of FIG. 6 or some other tool in various embodiments, or may be stand-alone in other embodiments, provides the ability to select a queue manager (a process that manages different message queues in various machines or applications), input queue and output queue for the particular sub-process being simulated. Each of these options, queue manager, input queue and output queue, can be changed by using the arrows to access a drop-down menu of predetermined alternatives. Once the alternatives are chosen, the module can be saved. Of course, in other embodiments non-predetermined alternatives may be used.

FIG. 8 shows an application construction tool, which can be used to select the applications used on either end of the queue or path. Here, there are two separate targets, one external, with a single monitoring message being sent to a central message database, before the source message is split and sent to both target applications. FIG. 9 shows the particular data fields or points that may be captured in the monitoring message. These are selected by highlighting the preferred fields in this embodiment.

Other alternatives are possible for other embodiments of the simulation module. For example, the embodiments discussed above have some alternatives as predetermined, which

8

makes the construction of sub-process modules more convenient. In other embodiments non-predetermined alternatives may be used. Moreover, any desired processes that are not defined in predetermined modules can be developed and made available to the user. For example, a tool such as that shown in FIG. 10 provides the ability to alter the process, the sub-process, and the application, by using the arrows to access a drop-down menu of predetermined alternatives, thus facilitating creation of new processes, sub-processes and/or activities. Other embodiments may use an "open ended" format to allow the creation of new processes and sub-processes and/or activities.

The simulation module is, in the preferred embodiments, either stand-alone or contained as part of a monitoring apparatus and/or system as had been described above. If the latter, then "real-time" data and processes, sub-processes and activities can be used in the simulation apparatus and/or process. The simulator module permits processes and sub-processes to be defined, simulated, and refined before modifying existent systems or implementing new systems.

The above description and the views and material depicted by the figures are for purposes of illustration only and are not intended to be, and should not be construed as, limitations on the invention.

Moreover, certain modifications or alternatives may suggest themselves to those skilled in the art upon reading of this specification, all of which are intended to be within the spirit and scope of the present invention as defined in the attached claims.

TABLE 1

PATH	FIELDS	IDENTIFIERS
B	PROCESS IDENTIFIER SUBPROCESS IDENTIFIER CUSTOMER NUMBER MATTER NUMBER QUOTE NUMBER QUANTITY PRICE AMOUNT DATE TIME	Order to cash, quote, custno, matno, quote num, qty, price, amt, date, time
C	PROCESS IDENTIFIER SUBPROCESS IDENTIFIER CUSTOMER NUMBER MATTER NUMBER QUOTE NUMBER QUANTITY PRICE AMOUNT DATE TIME	Order to cash, Agreement, custno, matno, quote num, qty, price, amt, date, time
D	PROCESS IDENTIFIER SUBPROCESS IDENTIFIER ORDER NUMBER QUOTE NUMBER CUSTOMER NUMBER MATTER NUMBER QUANTITY PRICE AMOUNT DATE TIME	Order to cash, order, ordernum, quote num, custno, matno, qty, price, amt, date, time
E	PROCESS IDENTIFIER SUBPROCESS IDENTIFIER ORDER NUMBER QUOTE NUMBER PRODUCTION NUMBER PRODUCTION DATE PRODUCTION LOCATION PRODUCTION STATUS CUSTOMER NUMBER	Order to cash, schedule, ordernum, quote num, production Number, Production date, production location, production status, custno,

TABLE 1-continued

PATH	FIELDS	IDENTIFIERS
	MATTER NUMBER	matno,
	QUANTITY	qty,
	PRICE	price,
	AMOUNT	amt,
	DATE	date,
	TIME	time
F	PROCESS IDENTIFIER	Order to cash,
	SUBPROCESS IDENTIFIER	mfg,
	ORDER NUMBER	ordernum,
	QUOTE NUMBER	quote num,
	PRODUCTION NUMBER	production Number,
	PRODUCTION DATE	Production date,
	PRODUCTION LOCATION	Production location,
	PRODUCTION STATUS	Production status,
	CUSTOMER NUMBER	custno,
	MATTER NUMBER	matno,
	QUANTITY	qty,
	PRICE	price,
	AMOUNT	amt,
	DATE	date,
	TIME	time
G	PROCESS IDENTIFIER	Order to cash,
	SUBPROCESS IDENTIFIER	ship,
	ORDER NUMBER	ordernum,
	QUOTE NUMBER	quote num,
	PRODUCTION NUMBER	production Number,
	PRODUCTION DATE	Production date,
	PRODUCTION LOCATION	production location,
	PRODUCTION STATUS	production status,
	CUSTOMER NUMBER	custno,
	SHIPPING DATE	ship date,
	MATTER NUMBER	matno,
	QUANTITY	qty,
	PRICE	price,
	AMOUNT	amt,
	DATE	date,
	TIME	time
H	PROCESS IDENTIFIER	Order to cash,
	SUBPROCESS IDENTIFIER	invoice,
	ORDER NUMBER	ordernum,
	QUOTE NUMBER	quote num,
	CUSTOMER NUMBER	custno,
	SHIPPING DATE	ship date,
	MATTER NUMBER	matno,
	QUANTITY	qty,
	PRICE	price,
	AMOUNT	amt,
	DATE	date,
	TIME	time

We claim:

1. A computerized method for use in an asynchronous messaging environment, wherein said messaging environment comprises at least one original message comprised of original message data, comprising:

providing, through a monitoring message, at least part of said original message data to a central message repository;

populating a transaction record in said central message repository with said original message data provided by said monitoring message wherein said original message data comprises status information of at least one action selected from the group consisting of activity, sub process and process; and,

retrieving information from the central message repository.

2. A method as in claim 1 wherein said retrieving information from the central message repository comprises retrieving information about an order from the central message repository.

3. A method as in claim 1 wherein said retrieving information from the central message repository comprises retrieving information about a customer from the central message repository.

4. A method as in claim 1 wherein said retrieving information from the central message repository comprises retrieving process efficiency information from the central message repository.

5. A method as in claim 1 wherein said retrieving information from the central message repository comprises retrieving time slice information from the central message repository.

6. A method as in claim 1 wherein said retrieving information from the central message repository comprises retrieving information across a time span from the central message repository.

7. A method as in claim 6 wherein said time span is selected from the group consisting of at least one day, at least one week, and at least one month.

8. A method as in claim 1 wherein said retrieving information from the central message repository comprises retrieving information to gauge trends from the central message repository.

9. A method as in claim 1 wherein said retrieving information from the central message repository comprises retrieving information to gauge performance from the central message repository.

10. A method as in claim 1 wherein said retrieving information from the central message repository comprises retrieving information across a time span from the central message repository to gauge trends.

11. A method as in claim 10 wherein said time span is selected from the group consisting of at least one day, at least one week, and at least one month.

12. A method as in claim 1 wherein said retrieving information from the central message repository comprises retrieving information across a time span from the central message repository to gauge performance.

13. A method as in claim 12 wherein said time span is selected from the group consisting of at least one day, at least one week, and at least one month.

14. A method as in claim 1 wherein said retrieving information from the central message repository comprises retrieving information about process efficiency.

15. A method as in claim 1 wherein said original message data comprises a data field.

16. A method as in claim 15 wherein said data field is path specific.

17. A method as in claim 1 wherein said original message data is generated from at least one action selected from the group consisting of activity, sub process and process, and wherein said action provides data which is used as a data field within said monitoring message.

18. A method as in claim 1 wherein said retrieving information from the central message repository comprises retrieving information in order to measure, monitor and track enterprise communications and processes.

19. A method as in claim 1 wherein said retrieving information from the central message repository comprises broadcasting unused pipeline capacity.

20. A method as in claim 1 wherein retrieving said information from the central message repository provides an alternative to retrieving original message data from an application that had originally generated said original message data.

21. A method as in claim 1 further comprising relieving monitoring pressure from a source application.

22. A method as in claim 1 further comprising providing a duplicate of said central message repository.

US 7,603,674 B2

11

23. A method as in claim 22 further comprising providing said duplicate to an external entity, with a communication channel established between said central message repository and said duplicate of said central message repository.

24. A method as in claim 1 further comprising providing a mirror repository of said central message repository.

25. A method as in claim 24 wherein said mirror repository is used by an external entity.

26. A method as in claim 25 wherein said mirror repository tracks processes, sub-processes and/or activities in whole or part.

27. A method as in claim 24 wherein, if more than one mirror repository is used, said repositories are combined.

28. A method as in claim 24 wherein said mirror repository is used either in addition to or instead of said central message repository.

29. A method as in claim 24 wherein said mirror repository or said central message repository may be used to generate messages and/or feedback to the group consisting of processes, sub-processes, activities or applications.

30. A method as in claim 24 wherein said mirror repository or said central message repository may be used to generate messages and/or feedback to users.

31. A method as in claim 30 wherein said messages comprise error messages.

32. A method as in claim 30 wherein said messages comprise event messages.

33. A method as in claim 30 wherein said messages comprise exception messages.

34. A method as in claim 30 wherein said messages comprise trigger messages.

35. A method as in claim 30 wherein said messages comprise threshold messages.

36. A method as in claim 30 wherein said messages comprise flagged indicators.

37. A method as in claim 30 wherein said messages comprise specially designated messages.

38. A method as in claim 1 wherein said retrieving information from the central message repository further comprises retrieving information from the central message repository on a secure basis.

39. A method as in claim 38 wherein said retrieving information from the central message repository on a secure basis further comprises a tiered secure basis, with a user obtaining retrieval rights according to the user's security classification.

40. A method as in claim 1 wherein said retrieving information from the central message repository further comprises permitting a user to retrieve information over a corporate extranet.

41. A method as in claim 1 further comprising providing a report.

42. A method as in claim 41 further comprising providing said report through an XML link to said central message repository.

43. A method as in claim 42 further comprising displaying said report.

44. A method as in claim 40 wherein said user comprises a customer, and said permitting a user to retrieve information over a corporate extranet further comprises permitting said customer to retrieve information concerning said customer's orders.

45. A method as in claim 43 wherein said display provides an option to drill down through said display for further detail.

46. A computerized method for use in an asynchronous messaging environment, wherein said messaging environment comprises at least one original message comprised of original message data, comprising:

12

providing, through a monitoring message, at least part of said original message data to a central message repository;

populating a transaction record in said central message repository with said original message data provided by said monitoring message wherein said original message data comprises status information of at least one action selected from the group consisting of activity, sub process and process; and,

distributing information from the central message repository using a real-time tool which tracks the progress of transaction records and/or processes.

47. A method as in claim 46 wherein said information is distributed using a distribution method selected from the group consisting of an intranet, an extranet, and the Internet.

48. A method as in claim 46 wherein said information is distributed to business partners.

49. A method as in claim 48 wherein said information is distributed to actual or potential business partners to check production capacity, shipping capacity, or other areas of interest.

50. A method as in claim 46 wherein said information is distributed to stock analysts to track any particular enterprise's productivity or other areas of interest.

51. A computerized method for use in an asynchronous messaging environment, wherein said messaging environment comprises at least one original message comprised of original message data, comprising:

providing, through a monitoring message, at least part of said original message data to a central message repository;

populating a transaction record in said central message repository with said original message data provided by said monitoring message;

reviewing data collected in said transaction record; wherein said original message data comprises status information of a process and/or sub process.

52. A method as in claim 51 wherein said original message data comprises at least one field of data selected from the group consisting of date data, time data, customer number data, materials data, quantity data and amount data.

53. A method as in claim 51 wherein said original message data comprises at least one field selected from the group consisting of PROCESS IDENTIFIER, SUB-PROCESS IDENTIFIER, ACTIVITY IDENTIFIER, CUSTOMER NUMBER, PART NUMBER, QUANTITY, DATE and TIME.

54. A method as in claim 51 wherein said original message data comprises at least one field selected from the group consisting of ProID, SbProID, Custno, Partno, Qty, Date and Time.

55. A method as in claim 51 further comprising providing the status of a process by providing access to said central message repository.

56. A method as in claim 51 further comprising adding, to said monitoring message, data other than said original message data.

57. A method as in claim 51 further comprising updating said transaction record.

58. A method as in claim 57 further comprising updating said transaction record by:

providing, through a second monitoring message, a second original message data to said transaction record; and,

populating said transaction record with said second original message data provided by said second monitoring message.

US 7,603,674 B2

13

59. A method as in claim 51 further comprising completing a process.

60. A method as in claim 51 further comprising completing said transaction record.

61. A method as in claim 51 further comprising aborting a process.

62. A method as in claim 61 further comprising providing, in said transaction record, an indication that the process has been aborted.

63. A central message repository created by the method of claim 51.

64. A transaction record created by the method of claim 51.

65. A method as in claim 51 wherein said process is a simulated process.

66. A method as in claim 51 wherein said sub process is a simulated sub process.

67. A method as in claim 51 wherein said original message data is simulated original message data.

68. A method as in claim 51 further comprising providing the status of a sub process by providing access to said central message repository.

69. A method as in claim 51 further comprising providing the status of an activity by providing access to said central message repository.

70. A computerized method for use in an asynchronous messaging environment, wherein said messaging environment comprises at least one original message comprised of original message data, comprising:

monitoring a sub process, which is comprised of at least a

first and second activity, by generating original message data from each of said first and second activities;

transmitting said original message data from said first activity, via a first monitoring message, to a central message repository;

storing said original message data from said first activity, in

a transaction record in said central message repository;

transmitting said original message data from said second activity, via a second monitoring message, to said central message repository; and,

storing said original message data from said second activity, in said transaction record in said central message repository;

wherein said original message data comprises the status of said activity.

71. A method as in claim 70 further comprising determining the status of said sub process.

72. A method as in claim 70 wherein said original message data from each of said first and second activities comprises an activity specific set of data.

73. A method as in claim 70 wherein said first monitoring message further comprises altered original message data.

74. A method as in claim 70 wherein said first monitoring message further comprises data added to said original message data.

75. A method as in claim 70 further comprising reviewing said central message repository.

76. A method as in claim 75 wherein reviewing said central message repository further comprises reviewing information from the group consisting essentially of order information, customer information, process efficiency information, snapshot information, time slice information, daily information, weekly information, monthly information, trend information and performance information.

77. A method as in claim 70 further comprising distributing process progress information in real time.

78. A method as in claim 70 further comprising distributing said process progress information through broadcasting.

14

79. A method as in claim 70 further comprising distributing said process progress information through the Internet.

80. A method as in claim 70 further comprising analyzing said central message repository in order to determine a process trend.

81. A method as in claim 80 wherein said process trend is selected from the group consisting of: time between sub-processes; variances by customer, variances by order amount, bottlenecks and seasonal variations.

82. A method as in claim 81 wherein orders may be accelerated as a result of said analysis.

83. A method as in claim 70 further comprising providing a monitoring message repository.

84. A method as in claim 70 further comprising providing a report via an XML link to said central message repository.

85. A method as in claim 70 wherein said second monitoring message further comprises altered original message data.

86. A method as in claim 70 wherein said second monitoring message further comprises data added to said original message data.

87. A method as in claim 70 further comprising distributing said process progress information through Wireless Application Protocol.

88. A method as in claim 70 further comprising distributing said process progress information through an intranet.

89. A method as in claim 70 further comprising distributing said process progress information through an extranet.

90. An apparatus for use in an asynchronous messaging environment in a communications system or systems wherein said messaging environment comprises at least one original message comprised of original message data, the apparatus comprising:

means for providing, through a monitoring message, at least part of said original message data to a central message repository;

means for populating a transaction record in said central message repository with said original message data provided by said monitoring message wherein said original message data comprises status information of at least one action selected from the group consisting of activity, sub process and process; and,

means for retrieving information from the central message repository.

91. An apparatus as in claim 90 wherein said means for retrieving information from the central message repository comprises means for retrieving information about an order from the central message repository.

92. An apparatus as in claim 90 wherein said means for retrieving information from the central message repository comprises means for retrieving information about a customer from the central message repository.

93. An apparatus as in claim 90 wherein said means for retrieving information from the central message repository comprises means for retrieving process efficiency information from the central message repository.

94. An apparatus as in claim 90 wherein said means for retrieving information from the central message repository comprises means for retrieving time slice information from the central message repository.

95. An apparatus as in claim 90 wherein said means for retrieving information from the central message repository comprises means for retrieving information across a time span from the central message repository.

96. An apparatus as in claim 95 wherein said time span is selected from the group consisting of at least one day, at least one week, and at least one month.

US 7,603,674 B2

15

97. An apparatus as in claim 90 wherein said means for retrieving information from the central message repository comprises means for retrieving information to gauge trends from the central message repository.

98. An apparatus as in claim 90 wherein said means for retrieving information from the central message repository comprises means for retrieving information to gauge performance from the central message repository.

99. An apparatus as in claim 90 wherein said means for retrieving information from the central message repository comprises means for retrieving information across a time span from the central message repository to gauge trends.

100. An apparatus as in claim 99 wherein said time span is selected from the group consisting of at least one day, at least one week, and at least one month.

101. An apparatus as in claim 90 wherein said means for retrieving information from the central message repository comprises means for retrieving information across a time span from the central message repository to gauge performance.

102. An apparatus as in claim 101 wherein said time span is selected from the group consisting of at least one day, at least one week, and at least one month.

103. An apparatus as in claim 90 wherein said means for retrieving information from the central message repository comprises means for retrieving information about process efficiency.

104. An apparatus as in claim 90 wherein said original message data comprises a data field.

105. An apparatus as in claim 104 wherein said data field is path specific.

106. An apparatus as in claim 90 wherein said original message data is generated from at least one action selected from the group consisting of activity, sub process and process an sub process, or process, and wherein said action provides data which is used as a data field within said monitoring message.

107. An apparatus as in claim 90 wherein said means for retrieving information from the central message repository comprises means for retrieving information in order to measure, monitor and/or track enterprise communications and processes.

108. An apparatus as in claim 90 wherein said means for retrieving information from the central message repository comprises broadcasting unused pipeline capacity.

109. An apparatus as in claim 90 wherein said means for retrieving said information from the central message repository provides an alternative to means for retrieving original message data from an application that had originally generated said original message data.

110. An apparatus as in claim 90 further comprising means for relieving monitoring pressure from a source application.

111. An apparatus as in claim 90 further comprising means for providing a duplicate of said central message repository.

112. An apparatus as in claim 111 further comprising means for providing said duplicate to an external entity, with a communication channel established between said central message repository and said duplicate of said central message repository.

113. An apparatus as in claim 90 further comprising means for providing a mirror repository of said central message repository.

114. An apparatus as in claim 113 wherein said mirror repository is used by an external entity.

115. An apparatus as in claim 113 wherein said mirror repository tracks processes, sub-processes and/or activities in whole or part.

16

116. An apparatus as in claim 113 wherein, if more than one minor repository is used, said repositories are combined.

117. An apparatus as in claim 113 wherein said mirror repository is used either in addition to or instead of said central message repository.

118. An apparatus as in claim 113 wherein said mirror repository or said central message repository may be used to generate messages and/or feedback to the group consisting of processes, sub-processes, activities or applications.

119. An apparatus as in claim 113 wherein said mirror repository or said central message repository may be used to generate messages and/or feedback to users.

120. An apparatus as in claim 119 wherein said messages comprise error messages.

121. An apparatus as in claim 119 wherein said messages comprise event messages.

122. An apparatus as in claim 119 wherein said messages comprise exception messages.

123. An apparatus as in claim 119 wherein said messages comprise trigger messages.

124. An apparatus as in claim 119 wherein said messages comprise threshold messages.

125. An apparatus as in claim 119 wherein said messages comprise flagged indicators.

126. An apparatus as in claim 119 wherein said messages comprise specially designated messages.

127. An apparatus as in claim 90 wherein said means for retrieving information from the central message repository further comprises retrieving information from the central message repository on a secure basis.

128. An apparatus as in claim 127 wherein said means for retrieving information from the central message repository on a secure basis further comprises a tiered secure basis, with a user obtaining retrieval rights according to the user's security classification.

129. An apparatus as in claim 90 wherein said means for retrieving information from the central message repository further comprises means for permitting a user to retrieve information over a corporate extranet.

130. An apparatus as in claim 90 further comprising means for providing a report.

131. An apparatus as in claim 130 further comprising means for providing said report through an XML link to said central message repository.

132. An apparatus as in claim 130 further comprising means for displaying said report.

133. An apparatus as in claim 129 wherein said user comprises a customer, and said means for permitting a user to retrieve information over a corporate extranet further comprises means for permitting said customer to retrieve information concerning said customer's orders.

134. An apparatus as in claim 132 wherein said means for displaying said report provides an option to drill down through a display generated by said means for displaying said report for further detail.

135. An apparatus for use in an asynchronous messaging environment in a communication system or systems, wherein said messaging environment comprises at least one original message comprised of original message data, the apparatus comprising:

means for providing, though a monitoring message, at least part of said original message data to a central message repository;

means for populating a transaction record in said central message repository with said original message data provided by said monitoring message wherein said original message data comprises status information of at least

US 7,603,674 B2

17

one action selected from the group consisting of activity, sub process and process; and, means for distributing information from the central message repository using a real-time tool which tracks the progress of transaction records and/or processes.

136. An apparatus as in claim **135** wherein said means for distributing information comprises a means for distributing information selected from the group consisting of an intranet, an extranet, and the Internet.

137. An apparatus as in claim **136** wherein said information is distributed to business partners.

138. An apparatus as in claim **137** wherein said information is distributed to actual or potential business partners to check production capacity, shipping capacity, or other areas of interest.

139. An apparatus as in claim **136** wherein said information is distributed to stock analysts to track any particular enterprise's productivity or other areas of interest.

140. An apparatus for use in an asynchronous messaging environment in a communication system or systems, wherein said messaging environment comprises at least one original message comprised of original message data, the apparatus comprising:

means for providing, through a monitoring message, at least part of said original message data to a central message repository;

means for populating a transaction record in said central message repository with said original message data provided by said monitoring message; and,

means for updating said transaction record; wherein said original message data comprises status information of a process and/or sub process.

141. An apparatus as in claim **140** wherein said original message data comprises at least one field of data selected from the group consisting of date data, time data, customer number data, materials data, quantity data and amount data.

142. An apparatus as in claim **140** wherein said original message data comprises at least one field selected from the group consisting of PROCESS IDENTIFIER, SUB-PROCESS IDENTIFIER, ACTIVITY IDENTIFIER, CUSTOMER NUMBER, PART NUMBER, QUANTITY, DATE and TIME.

143. An apparatus as in claim **140** wherein said original message data comprises at least one field selected from the group consisting of ProID, SbProID, Custno, Partno, Qty, Date and Time.

144. An apparatus as in claim **140** further comprising updating said transaction record by:

means for providing, through a second monitoring message, a second original message data to said transaction record; and,

means for populating said transaction record with said second original message data provided by said second monitoring message.

145. An apparatus as in claim **140** further comprising completing a process.

146. An apparatus as in claim **140** further comprising completing said transaction record.

147. An apparatus as in claim **140** further comprising aborting a process.

148. An apparatus as in claim **140** further comprising providing, in said transaction record, an indication that the record has been abandoned.

149. A central message repository created by the method of claim **140**.

150. A transaction record created by the method of claim **140**.

18

151. An apparatus as in claim **140** wherein said process is a simulated process.

152. An apparatus as in claim **140** wherein said sub process is a simulated sub process.

153. An apparatus as in claim **140** wherein said original message data is simulated original message data.

154. An apparatus for use in an asynchronous messaging environment in a communication system or systems, wherein said messaging environment comprises at least one original message comprised of original message data, the apparatus comprising:

means for monitoring a sub process, which is comprised of at least a first and second activity, by generating original message data from each of said first and second activities;

means for transmitting said original message data from said first activity, via a first monitoring message, to a central message repository;

means for storing said original message data from said first activity, in a transaction record in said central message repository;

means for transmitting said original message data from said second activity, via a second monitoring message, to said central message repository; and,

means for storing said original message data from said second activity, in said transaction record in said central message repository;

wherein said original message data comprises the status of said activity.

155. An apparatus as in claim **154** further comprising determining the status of said sub process.

156. An apparatus as in claim **154** wherein said original message data from each of said first and second activities comprises an activity specific set of data.

157. An apparatus as in claim **155** wherein said first monitoring message further comprises altered original message data.

158. An apparatus as in claim **155** wherein said first monitoring message further comprises data added to said original message data.

159. An apparatus as in claim **155** further comprising means for reviewing said central message repository.

160. An apparatus as in claim **159** wherein reviewing said central message repository further comprises reviewing information from the group consisting essentially of order information, customer information, process efficiency information, snapshot information, time slice information, daily information, weekly information, monthly information, trend information and performance information.

161. An apparatus as in claim **155** further comprising distributing process progress information in real time.

162. An apparatus as in claim **161** further comprising distributing said process progress information through broadcasting.

163. An apparatus as in claim **161** further comprising distributing said process progress information through the Internet.

164. An apparatus as in claim **155** further comprising analyzing said central message repository in order to determine a process trend.

165. An apparatus as in claim **154** wherein said process trend is selected from the group consisting of: time between sub-processes, variances by customer, variances by order amount, bottlenecks and seasonal variations.

166. An apparatus as in claim **165** wherein orders may be accelerated as a result of said analysis.

US 7,603,674 B2

19

167. An apparatus as in claim 155 further comprising providing a monitoring message repository.

168. An apparatus as in claim 155 further comprising providing a report via an XML link to said central message repository.

169. An apparatus as in claim 155 wherein said second monitoring message further comprises altered original message data.

170. An apparatus as in claim 155 wherein said second monitoring message further comprises data added to said original message data.

20

171. An apparatus as in claim 155 further comprising distributing said process progress information through Wireless Application Protocol.

172. An apparatus as in claim 155 further comprising distributing said process progress information through an intranet.

173. An apparatus as in claim 155 further comprising distributing said process progress information through an extranet.

* * * * *