

**IN THE UNITED STATES DISTRICT COURT  
FOR THE EASTERN DISTRICT OF TEXAS  
(MARSHALL DIVISION)**

**BISHOP DISPLAY TECH LLC,**

**Plaintiff,**

v.

**HEESUNG ELECTRONICS LTD.,**

**Defendant.**

§  
§  
§  
§  
§  
§  
§  
§  
§  
§  
§  
§  
§  
§  
§

**C.A. No. 2:24-cv-87**

**JURY TRIAL DEMANDED**

**PLAINTIFF’S ORIGINAL COMPLAINT FOR PATENT INFRINGEMENT**

Plaintiff Bishop Display Tech LLC (“Bishop” or “Plaintiff”) files this Original Complaint against Defendant Heesung Electronics Ltd. (“Heesung” or “Defendant”) for infringement of U.S. Patent No. 6,819,377 (the “’377 patent”), U.S. Patent No. 6,822,706 (the “’706 patent”), U.S. Patent No. 7,583,347 (the “’347 patent”), and U.S. Patent No. 7,414,682 (the “’682 patent”) (collectively, the “Asserted Patents”).

**THE PARTIES**

1. Plaintiff is a Texas limited liability company with its principal place of business in the Eastern District of Texas.
2. On information and belief, Heesung Electronics Ltd. is a corporation organized under the laws of Korea. Its principal place of business is at 63, Seongseogongdan-ro 11-gil, Daiseo-gu, Daegu, Korea (704-230).
3. Defendant is engaged (including, as relevant, in the past) in making, using, selling, offering for sale, and/or importing, and/or inducing its respective subsidiaries, affiliates, distributors, suppliers, retail partners, and customers in the making, using, selling, offering for sale,

and/or importing throughout the United States, including within this District, the following products accused of infringement (the “Accused Products”):

- Heesung liquid crystal modules comprising thin-film transistor liquid crystal displays (“TFT-LCDs”) (collectively, “LCMs”);
- Heesung TFT-LCDs; and
- Products comprising Heesung TFT-LCDs or LCMs.

4. On information and belief, Heesung, including its respective U.S. based employees, agents, distributors, affiliates, retail partners, and customers (which act as part of a global network and supply chain of overseas sales and manufacturing subsidiaries), have operated as agents of one another and vicariously as parts of the same business group to work in concert together and enter into agreements that are nearer than arm’s length. Heesung and its U.S.-based employees, agents, distributors, affiliates, retail partners, and/or customers, individually and/or in concert, conduct business (and have conducted business) in the United States, including importing, distributing, offering to sell, and selling the Accused Products that incorporate devices, systems, and processes that infringed the Asserted Patents in Texas and this District. *See Trois v. Apple Tree Auction Center, Inc.*, 882 F.3d 485, 490 (5th Cir. 2018) (“A defendant may be subject to personal jurisdiction because of the activities of its agent within the forum state....”); *see also Cephalon, Inc. v. Watson Pharmaceuticals, Inc.*, 629 F. Supp. 2d 338, 348 (D. Del. 2009) (“The agency theory may be applied not only to parents and subsidiaries, but also to companies that are ‘two arms of the same business group,’ operate in concert with each other, and enter into agreements with each other that are nearer than arm’s length.”).

5. On information and belief, LG Electronics Inc. (“LGE”) is a publicly traded corporation organized under the laws of Korea. Its principal place of business is at LG Twin Tower 128, Yeoui-daero, Yeongdeungpo-gu, 07336, Seoul, South Korea.

6. On information and belief, LG Electronics U.S.A., Inc. (“LGEUS”), is a Delaware corporation with a principal place of business at 111 Sylvan Avenue, North Building, Englewood Cliffs, New Jersey 07632. LGEUS is a wholly-owned subsidiary of LGE, and has regular and established places of business within this District at 2153-2155 Eagle Pkwy, Fort Worth, TX 76177 and 14901 Beach St, Fort Worth, TX 76177.

7. On information and belief, LG Display Co., Ltd. (“LGD”) is a corporation organized under the laws of Korea. Its principal place of business is at LG Twin Tower 128, Yeoui-daero, Yeongdeungpo-gu, 07336, Seoul, South Korea.

8. Through offers to sell, sales, imports, distributions, and other related agreements to transfer ownership of Defendant’s Accused Products by and/or to affiliates, distributors, subsidiaries, suppliers, retail partners, customers, and/or agents, Defendant is operating in (and has operated in) and maintaining (and maintained) a significant business presence in the U.S. and/or through its U.S. subsidiaries or agents, Defendant has done (and does) business in the U.S., the state of Texas, and in the Eastern District of Texas.

**JURISDICTION AND VENUE**

9. Plaintiff incorporates paragraphs 1 through 8 herein by reference.

10. This action arises under the patent laws of the United States, namely 35 U.S.C. §§ 271, 281, and 284-285, among others.

11. This Court has subject matter jurisdiction pursuant to 28 U.S.C. §§ 1331 and 1338(a).

12. Venue is proper for Heesung in this District pursuant to 28 U.S.C. §§ 1391(c). Heesung is a foreign entity and may be sued in any judicial district under 28 U.S.C. § 1391(c)(3).

13. This Court has general and specific personal jurisdiction over the Defendant pursuant to due process and/or the Texas Long Arm Statute because, inter alia, (i) the Defendant has done and continues to do business in Texas and/or (ii) the Defendant has, directly and through intermediaries, distributors, agents, and/or others committed and continues to commit acts of patent infringement in the State of Texas, including making, using, offering to sell, and/or selling Accused Products in Texas, and/or importing Accused Products into Texas, including by Internet sales and/or sales via retail and wholesale stores, inducing others to commit acts of patent infringement in Texas, and/or committing at least a portion of any other infringements alleged herein. Defendant has placed, and is continuing to place, infringing products into the stream of commerce, via established distribution channels, with the knowledge and/or understanding that such products are sold in Texas, including in this District. Defendant has derived substantial revenues from its infringing acts occurring within Texas and within this District. Defendant has substantial business in this State and District (including, as relevant, in the past), including: (A) conducting at least part of its infringing activities alleged herein; and (B) regularly doing or soliciting business, engaging in other persistent conduct, and/or deriving substantial revenue from infringing goods offered for sale, sold, and/or imported, and services provided to Texas residents vicariously through and/or in concert with its respective alter egos, intermediaries, agents, distributors, importers, customers, subsidiaries, and/or consumers.

14. This Court has personal jurisdiction over Defendant, directly or through agents, intermediaries, distributors, importers, customers, subsidiaries, and/or consumers. Through direction and control (including, as relevant, in the past) of such subsidiaries, affiliates,

distributors, retail partners, agents, and/or customers, Defendant has committed acts of direct and/or indirect patent infringement within Texas, and elsewhere within the United States, giving rise to this action and/or have established minimum contacts with Texas such that personal jurisdiction over Defendant would not offend traditional notions of fair play and substantial justice. Upon information and belief, Defendant compensates its U.S.-based subsidiaries and/or agents for their sales support services in the United States. As such, Defendant has a direct financial interest in its U.S.-based subsidiaries and/or agents, and vice versa.

15. Personal jurisdiction is proper because Defendant has committed acts of infringement in this District. This Court has personal jurisdiction over Defendant because, *inter alia*, this action arises from activities Defendant purposefully directed towards the State of Texas and this District.

16. Exercising personal jurisdiction over Defendant in this District would not be unreasonable given Defendant's contacts in this District, the interest in this District of resolving disputes related to products sold herein, and the harm that would occur to Plaintiff who resides in this District.

17. In addition, Defendant has knowingly induced infringement within this District by advertising, marketing, offering for sale and/or selling devices pre-loaded with infringing functionality within this District, to consumers, customers, manufacturers, distributors, resellers, partners, end users, and/or LGE, LGEUS, and/or LGD, and providing instructions, user manuals, advertising, and/or marketing materials which facilitate, direct or encourage the use of infringing functionality with knowledge thereof.

18. Personal jurisdiction also exists specifically over Defendant because Defendant, directly or through affiliates, subsidiaries, agents, and/or intermediaries, transact business (or have

transacted business) in this State or purposefully directed business at this State by making, importing, offering to sell, selling, and/or having sold infringing products within this State and District or purposefully directed at this State or District.

19. To the extent Heesung is not subject to jurisdiction in any state's court of general jurisdiction, exercising jurisdiction over Heesung in this State and this District would be consistent with due process and this State's long-arm statute and under national contacts in light of the facts alleged in this Complaint.

20. In addition, Heesung, directly or through affiliates, subsidiaries, agents, and/or intermediaries, have placed infringing products into the stream of commerce knowing they would be sold and used in Texas, and economically benefit from the retail sale of infringing products in this State, including in this District.

21. Defendant has advertised its infringing products to customers in Texas and this District through its website.

22. On information and belief, Heesung controls (or has controlled) or otherwise directs (or directed) and authorizes (or authorized) all activities of its U.S.-based agents and/or sales and/or distribution subsidiaries. Such directed and authorized activities include the U.S.-based subsidiaries' and/or agents having used, offered for sale, sold, and/or imported the Accused Products, their components, processes, and/or products containing the same that incorporated the fundamental technologies and claims of the Asserted Patents. Heesung's U.S.-based sales and/or distribution subsidiaries and/or agents were authorized to import, distribute, sell, or offer for sale the Accused Products on behalf of Heesung. For example, Heesung researched, designed, developed, and manufactured the Accused Products, and then directed its U.S.-based sales subsidiaries, distributors, agents, and/or others to import, distribute, offer for sale, and sell the

Accused Products in the United States. *See, e.g., United States v. Hui Hsiung*, 778 F.3d 738, 743 (9th Cir. 2015) (finding that the sale of infringing products to third parties rather than for direct import into the U.S. did not “place [defendants’] conduct beyond the reach of United States law [or] escape culpability under the rubric of extraterritoriality”). Thus, Heesung conducted infringing activities, and Heesung’s U.S.-based sales subsidiaries and/or distributors and/or agents conducted infringing activities on behalf of Heesung.

23. On information and belief, Heesung’s U.S.-based sales and/or distribution subsidiaries’ and/or agents’ presence (including in the past) in the United States gave Heesung substantially the same business advantages that it would have enjoyed if Heesung conducted its business through its own offices or paid agents. Heesung’s U.S.-based sales subsidiaries and/or distributors and/or agents were authorized to import, distribute, sell, and offer for sale Heesung’s products, including the Accused Products, as well as their components and processes related to the same, on behalf of Heesung. For example, Heesung’s U.S.-based sales subsidiaries and/or agents operated within Heesung’s global network and supply chain of sales. In the U.S., including within the Eastern District of Texas, the Accused Products, as well as their components and processes related to the same, were imported, distributed, offered for sale, and/or sold.

24. Via Heesung’s alter egos, agents, intermediaries, distributors, importers, customers, subsidiaries, and/or consumers that maintained a business presence, operating in, and/or residing in the U.S., Heesung’s products, including products and processes accused of infringing the Asserted Patents, are or have been widely distributed and sold in Texas including within this District. *See Litecubes, LLC v. Northern Light Products, Inc.*, 523 F.3d 1353, 1369-70 (Fed. Cir. 2008) (“[T]he sale [for purposes of § 271] occurred at the location of the buyer.”); *see also Semcon IP Inc. v. Kyocera Corp.*, No. 2:18-cv-00197-JRG, 2019 WL 1979930, at \*3 (E.D. Tex. May 3,

2019) (denying accused infringer's motion to dismiss because plaintiff sufficiently plead that purchases of infringing products outside of the United States for importation into and sales to customers in the U.S. may constitute an offer to sell under § 271(a)).

25. On information and belief, Heesung has placed infringing products and/or products that practiced infringing processes into the stream of commerce via established distribution channels comprising at least its subsidiaries, affiliates, distributors, and/or agents or customers, with the knowledge and/or intent that those products were imported, used, offered for sale, and sold in the United States and Texas, including in this District. As a result, Heesung has, vicariously through and/or in concert with alter egos, agents, intermediaries, distributors, affiliates, importers, customers, subsidiaries, and/or consumers, placed the Accused Products into the stream of commerce via established distribution channels with the knowledge and/or intent that those products were sold and continue to be sold in the United States and Texas, including in this District.

26. For example, and on information and belief, Heesung imports, and/or has imported and/or shipped infringing Accused Products into the United States through and with its supply chain partner and/or customer LGE (including, but not limited to, LGE subsidiaries and/or affiliates and/or agents, such as LX International (America), Inc). Such Accused Products are directed to this District and available for purchase in this District via retailers, such as Best Buy. Also by way of example, and on information and belief, Heesung has (and has had) U.S. based employees that work in connection with the Accused Products, including, but not limited to, engineers who have identified Heesung as an "LG Partner."

27. In the alternative, the Court has personal jurisdiction over Heesung under Federal Rule of Civil Procedure 4(k)(2), because the claims for patent infringement in this action arise



under federal law, Heesung is not subject to the jurisdiction of the courts of general jurisdiction of any state and exercising jurisdiction over Heesung is consistent with the U.S. Constitution.

**COUNT I**  
**(Infringement of U.S. Patent No. 6,819,377)**

28. Plaintiff incorporates paragraphs 1 through 27 herein by reference.

29. This cause of action arises under the patent laws of the United States, and in particular, 35 U.S.C. §§ 271, *et seq.*

30. Plaintiff is the owner of the '377 patent with all substantial rights to the '377 patent including the exclusive right to enforce, sue, and recover damages for past infringement.

31. The '377 patent is valid, enforceable and was duly issued in full compliance with Title 35 of the United States Code.

**DIRECT INFRINGEMENT (35 U.S.C. §271(a))**

32. Heesung has infringed literally, and/or under the Doctrine of Equivalents, one or more claims of the '377 patent in this District and elsewhere in Texas and the United States.

33. Heesung directly infringed the '377 patent via 35 U.S.C. § 271(a) by having made, offered for sale, sold, used, tested, and/or imported those Accused Products, their components and processes, and/or products containing the same that incorporate the fundamental technologies and claims of the '377 patent. For example, Heesung, either by itself and/or via an agent, directly infringed the '377 patent by offering for sale, selling, and/or importing those Accused Products, their components and processes, and/or products containing the same that incorporate the fundamental technologies and claims of the '377 patent, to and/or via its alter egos, agents, intermediaries, distributors, importers, customers, subsidiaries, and/or consumers. Furthermore, on information and belief, Heesung sold and made some Accused Products outside of the United States, delivered those products to its customers, agents, distributors, and/or subsidiaries in the

United States, or in the case that it delivered the Accused Products outside of the United States it did so intending and/or knowing that those products were destined for the United States and/or designed those products for sale in the United States, thereby directly infringing the '377 patent. *See, e.g., Lake Cherokee Hard Drive Techs., L.L.C. v. Marvell Semiconductor, Inc.*, 964 F. Supp. 2d 653, 658 (E.D. Tex. 2013).

34. For example, Heesung infringed claim 1 of the '377 patent. The products accused of infringing the '377 patent comprise a liquid crystal display device. For example, LG's TV model no. 49SM8600PUA includes Heesung LCM model no. HC49EQH-SLXA1-211X, which includes an LGD LCD (model no. not identified on device), such that each comprises a liquid crystal display device:



35. The products accused of infringing the '377 patent comprise a liquid crystal panel comprising liquid crystal cells, a first plate disposed on a displaying side of the cells, and a second

plate disposed on a reverse side of the cells. For example, an examination of LGD's TFT-LCD included in Heesung LCM model no. HC49EQH-SLXA1-211X demonstrates this:

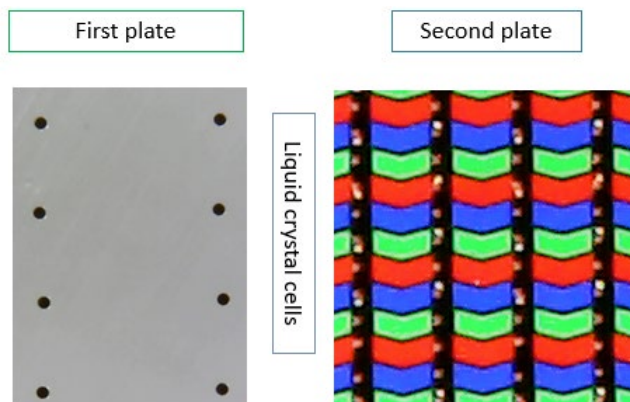

36. The products accused of infringing the '377 patent comprise a liquid crystal driver electrically connected with the liquid crystal panel through a circuit pattern. For example, examination of LGD's TFT-LCD included in Heesung LCM model no. HC49EQH-SLXA1-211X demonstrates this:

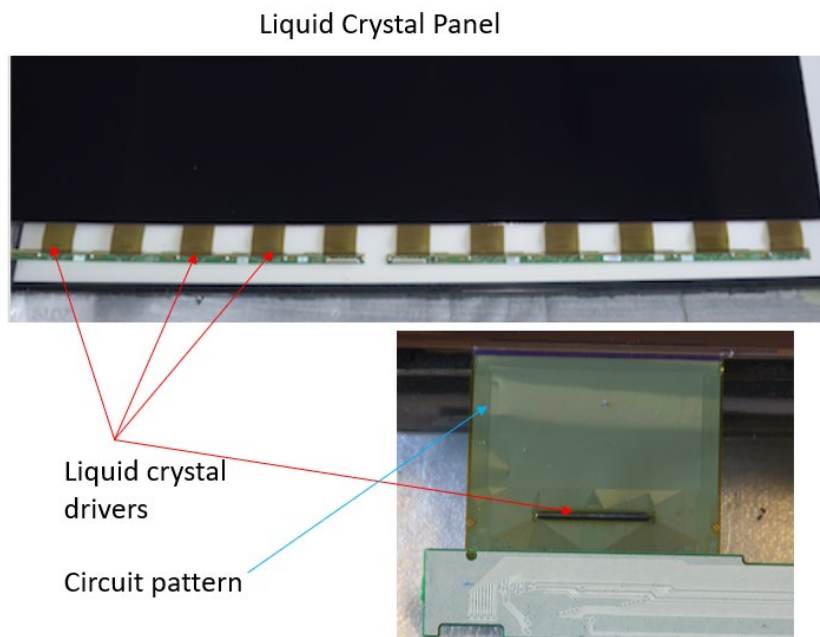

37. The products accused of infringing the '377 patent comprise a light shielding material disposed adjacent said liquid crystal driver so as to prevent an outer light from being incident to said liquid crystal driver. An examination of LGD's TFT-LCD included in Heesung LCM model no. HC49EQH-SLXA1-211X demonstrates this:

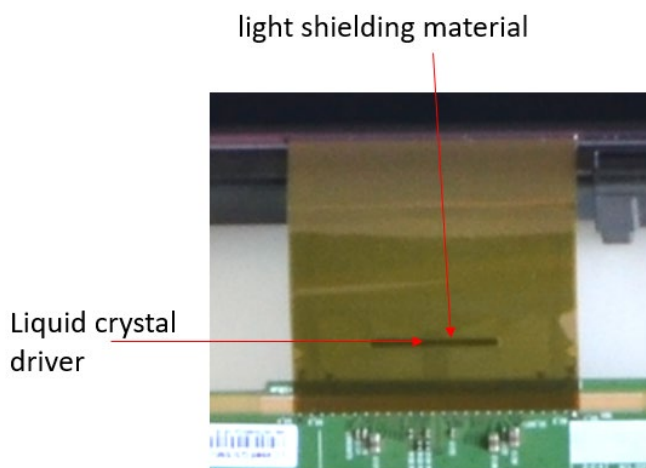

38. The products accused of infringing the '377 patent comprise a film carrier comprising said circuit pattern formed on a resin film. For example, an examination of LGD's TFT-LCD included in Heesung LCM model no. HC49EQH-SLXA1-211X demonstrates this:

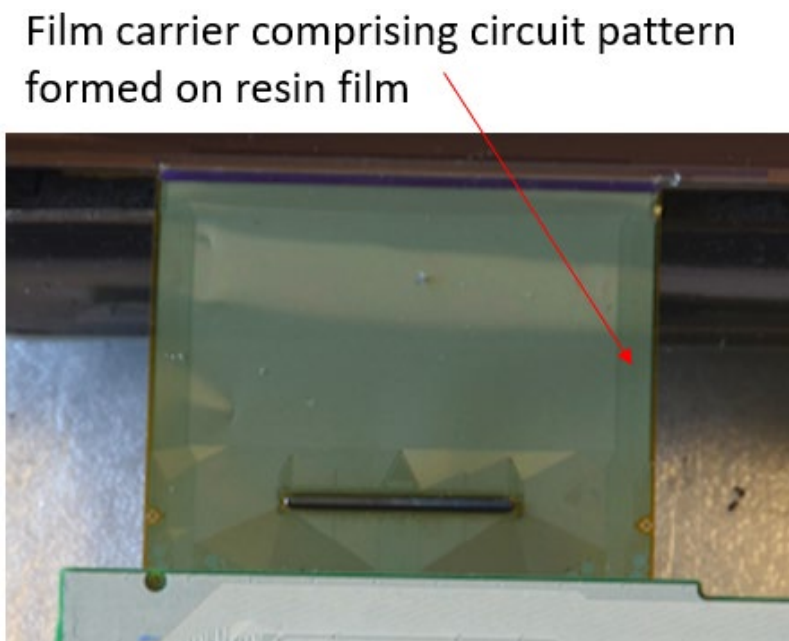

39. The products accused of infringing the '377 patent are configured such that the liquid crystal driver is mounted on the liquid crystal panel by a light shielding resin disposed on said liquid crystal panel so as to cover one end of the film carrier and a side surface of said liquid crystal driver. For example, an examination of LGD's TFT-LCD included in Heesung LCM model no. HC49EQH-SLXA1-211X demonstrates this:

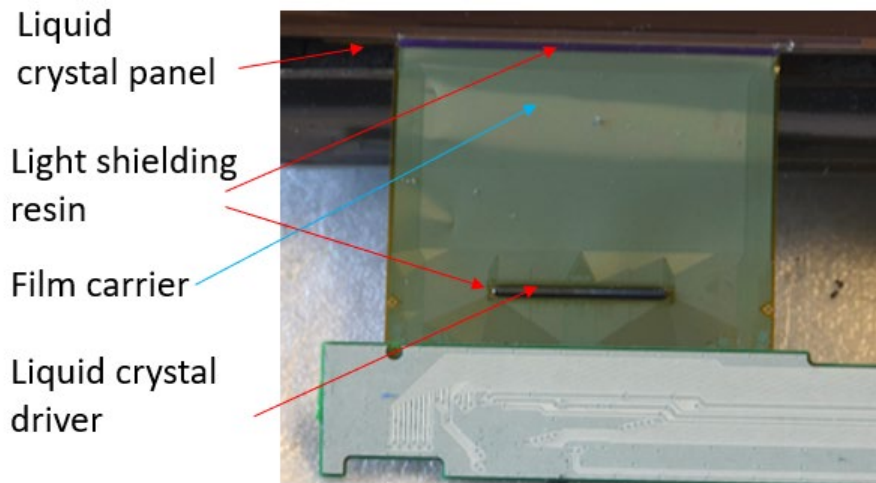

40. Plaintiff has been damaged as a result of Defendant's infringing conduct described in this Count. Defendant is, thus, liable to Plaintiff in an amount that adequately compensates Plaintiff for Defendant's infringements, which, by law, cannot be less than a reasonable royalty, together with interest and costs as fixed by this Court under 35 U.S.C. § 284.

41. Plaintiff has complied with the requirements of 35 U.S.C. § 287, to the extent necessary and/or applicable, and is entitled to collect pre- and post-filing damages for Defendant's infringements of the '377 patent.

**COUNT II**  
**(Infringement of U.S. Patent No. 6,822,706)**

42. Plaintiff incorporates paragraphs 1 through 41 herein by reference.

43. This cause of action arises under the patent laws of the United States, and in particular, 35 U.S.C. §§ 271, *et seq.*

44. Plaintiff is the owner of the '706 patent with all substantial rights to the '706 patent including the exclusive right to enforce, sue, and recover damages for past infringement.

45. The '706 patent is valid, enforceable and was duly issued in full compliance with Title 35 of the United States Code.

**DIRECT INFRINGEMENT (35 U.S.C. §271(a))**

46. Heesung has infringed literally, and/or under the Doctrine of Equivalents, one or more claims of the '706 patent in this District and elsewhere in Texas and the United States.

47. Heesung directly infringed the '706 patent via 35 U.S.C. § 271(a) by having made, offered for sale, sold, used, tested, and/or imported those Accused Products, their components and processes, and/or products containing the same that incorporate the fundamental technologies and claims of the '706 patent. For example, Heesung, either by itself and/or via an agent, directly infringed the '706 patent by offering for sale, selling, and/or importing those Accused Products, their components and processes, and/or products containing the same that incorporate the fundamental technologies and claims of the '706 patent, to and/or via its alter egos, agents, intermediaries, distributors, importers, customers, subsidiaries, and/or consumers. Furthermore, on information and belief, Heesung sold and made some Accused Products outside of the United States, delivered those products to its customers, agents, distributors, and/or subsidiaries in the United States, or in the case that it delivered the Accused Products outside of the United States it did so intending and/or knowing that those products were destined for the United States and/or designed those products for sale in the United States, thereby directly infringing the '706 patent.

See, e.g., *Lake Cherokee Hard Drive Techs., L.L.C. v. Marvell Semiconductor, Inc.*, 964 F. Supp. 2d 653, 658 (E.D. Tex. 2013).

48. For example, Heesung infringed claim 1 of the '706 patent. The products accused of infringing the '706 patent comprise a liquid crystal display device. For example, LG's TV model no. 49SM8600PUA includes Heesung LCM model no. HC49EQH-SLXA1-211X, which includes an LGD LCD (model no. not identified on device), such that each comprises a liquid crystal display device:

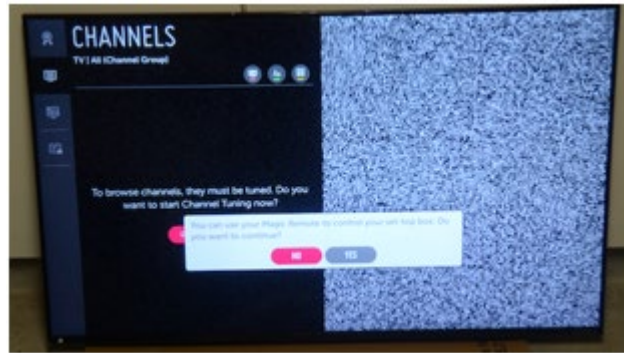

49. The products accused of infringing the '706 patent comprise a liquid crystal device comprising liquid crystal cells, a first plate disposed on a displaying side of the cells, and a second plate disposed on a reverse side of the cells. For example, an examination of LGD's TFT-LCD included in Heesung LCM model no. HC49EQH-SLXA1-211X demonstrates this:

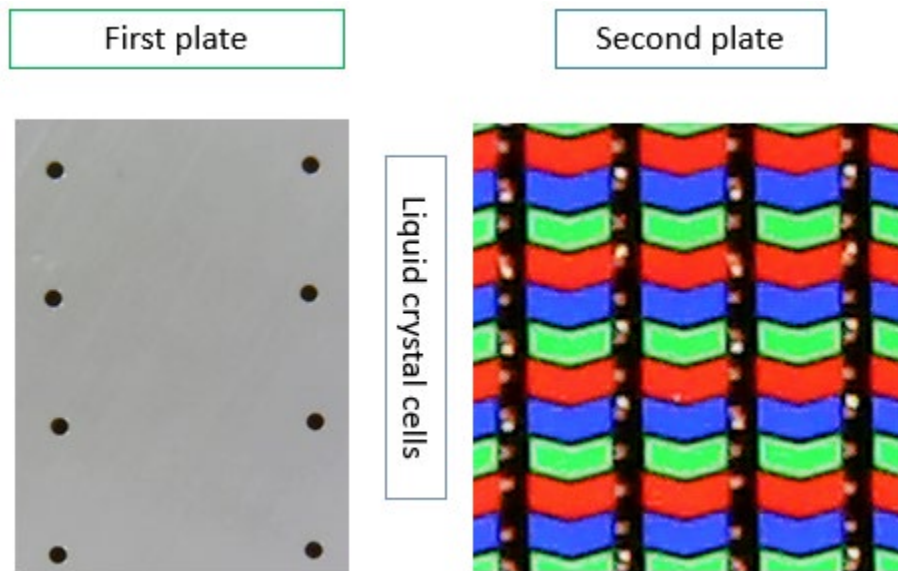

50. The products accused of infringing the '706 patent comprise a liquid crystal driver electrically connected with the liquid crystal panel through a circuit pattern. For example, an examination of LGD's TFT-LCD included in Heesung LCM model no. HC49EQH-SLXA1-211X demonstrates this:

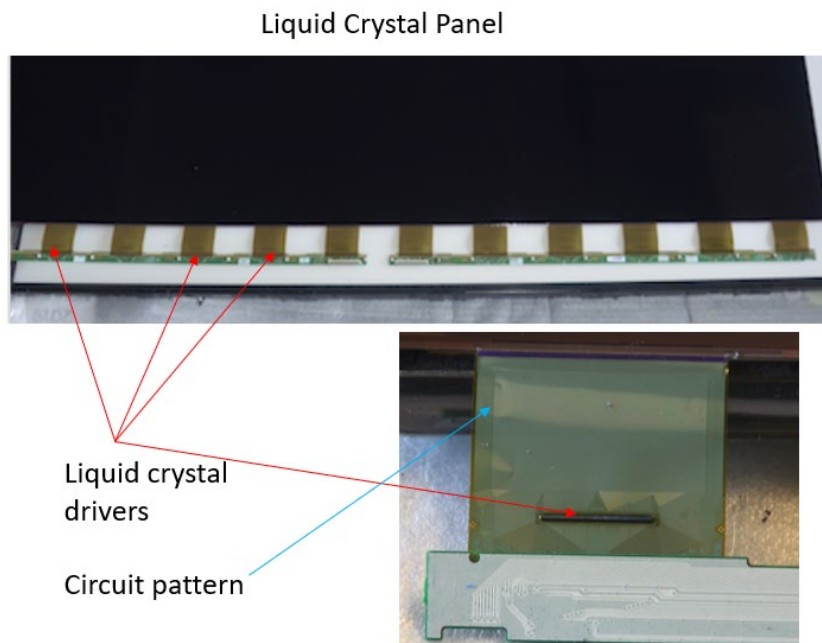



51. The products accused of infringing the '706 patent comprise a first light shielding material disposed adjacent a face of said liquid crystal driver so as to prevent an outer light from being incident to said liquid crystal driver. For example, an examination of LGD's TFT-LCD included in Heesung LCM model no. HC49EQH-SLXA1-211X demonstrates this:

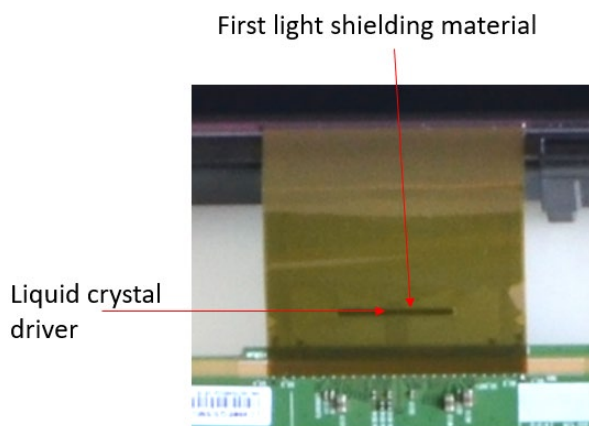

52. The products accused of infringing the '706 patent comprise a second light shielding material disposed adjacent an opposite face of said liquid crystal driver so as to prevent an outer light from being incident to said liquid crystal driver. For example, an examination of LGD's TFT-LCD included in Heesung LCM model no. HC49EQH-SLXA1-211X demonstrates this:

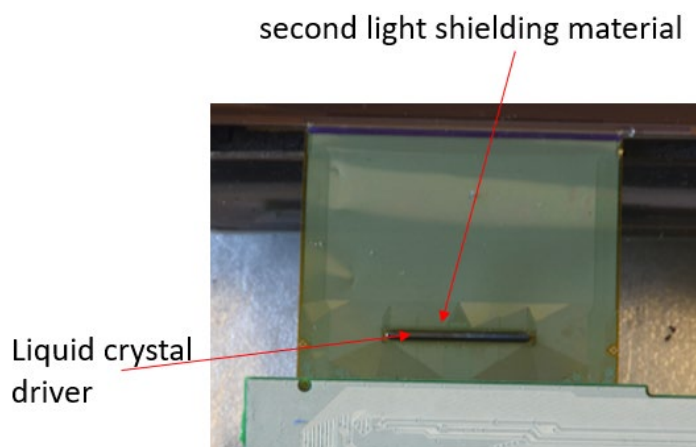

53. The products accused of infringing the '706 patent comprise a diffusion sheet located adjacent said liquid crystal display panel. An examination of Heesung LCM model no. HC49EQH-SLXA1-211X, which includes the LGD LCD (model no. not identified on device), demonstrates this:

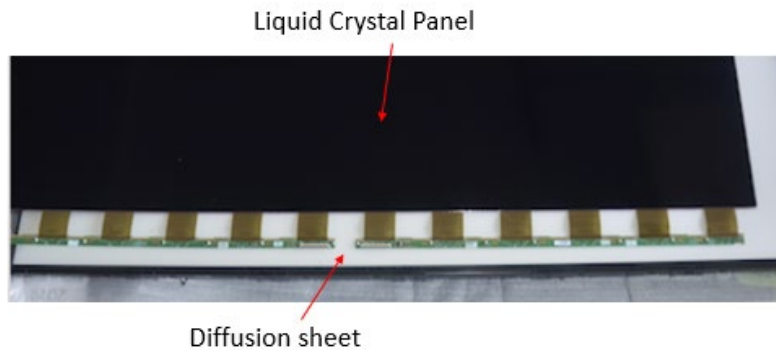

54. The products accused of infringing the '706 patent are configured such that the diffusion sheet comprises a light absorbing area and a light absorbing area located on the outer periphery thereof, the light diffusing area serving to diffuse illumination light from a light source to the liquid crystal display panel, and the light absorbing area serving to absorb the extraneous light incident on said liquid crystal driver. For example, an examination of Heesung LCM model no. HC49EQH-SLXA1-211X, which includes the LGD LCD (model no. not identified on device), demonstrates this:

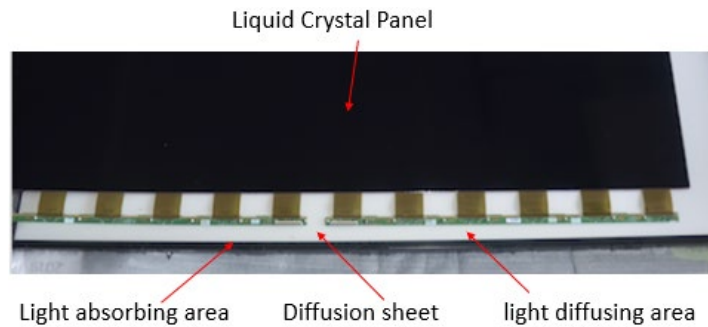

55. At a minimum, LGE, LGEUS, and LGD have known about the '706 patent since at least February 8, 2017, when LGD received notice of their infringement from a former patent owner Godo Kaisha IP Bridge 1, and at least by March 7, 2017 when LGD replied to the notice letter. Moreover, Heesung, based on information and belief, was on notice of the '706 patent from at least the foregoing dates as a result of indemnity, contractual, and/or its business relationship with LGE, LGEUS, and/or LGD and did, as a result, receive actual or constructive notice and/or knowledge of the '706 patent. On information and belief, display manufacturers, such as LGE and LGD, once placed on notice of infringement, would, as prudent businesses, provide that same notice to suppliers and component suppliers.<sup>1</sup>

#### **INDIRECT INFRINGEMENT (35 U.S.C. §271(b))**

56. On information and belief, since at least the above-mentioned dates when Heesung was on notice of its infringement, Heesung actively induced, under U.S.C. § 271(b), distributors, retailers, customers, subsidiaries, importers, testing outfits, and/or consumers to directly infringe one or more claims of the '706 patent by making, using, offering for sale, selling, and/or importing the Accused Products. Since at least the notice provided on the above-mentioned dates, Heesung did so with knowledge, or with willful blindness of the fact, that the induced acts constitute infringement of the '706 patent. Heesung has caused and/or intended to cause, and took affirmative steps to induce infringement by distributors, retailers, customers, subsidiaries, importers, testing

---

<sup>1</sup> See e.g., *Nat'l Inst. for Strategic Tech. Acquisition & Commercialization v. Nissan of N. Am.*, No. 11-11039, 2012 U.S. Dist. LEXIS 117941, at \*14 (E.D. Mich. Aug. 21, 2012) (“Defendants argue the sheer implausibility of an automotive supplier informing its customers that it is supplying infringing products to them. Without a fully developed factual record however, the court cannot conclude that it is unreasonable to infer that defendants Toyota and Nissan received pre-suit knowledge of the patents-in-suit from their suppliers. A reasonable inference can be made that a supplier of an accused infringing instrumentality, with direct notice of the patents-in-suit, discussed said patents and the likelihood of infringement of these patents with its customers. It is also a reasonable inference that a Japanese parent company, Honda Motor Company, which received NISTAC's letter concerning the patents-in-suit, would communicate with its United States subsidiary, American Honda, about these patents and potential infringement thereof.”).

outfits, and/or consumers by at least, inter alia, creating advertisements that promote the infringing use of the Accused Products, creating and/or maintaining established distribution channels for the Accused Products into and within the United States, manufacturing the Accused Products in conformity with U.S. laws and regulations, distributing or making available instructions or manuals for these products to purchasers and prospective buyers, testing and certifying features related to infringing features in the Accused Products, and/or providing technical support, replacement parts, or services for these products to these purchasers in the United States. As just one example, Heesung actively induced distributors, retailers, customers, subsidiaries, importers, testing outfits, and/or consumers that have purchased, imported, used, offered for sale, and/or sold Accused Products in the U.S. by marking the Accused Products with UL Solutions labels indicating compliance with U.S. laws and regulations for the Accused Products destined and intended to be sold in the U.S. <https://marks.ul.com/about/ul-listing-and-classification-marks/appearance-and-significance/marks-for-north-america/>. In another example, Heesung actively induced distributors, retailers, customers, subsidiaries, importers, testing outfits, and/or consumers that have purchased, imported, used, offered for sale, and/or sold to include the accused Heesung TFT-LCDs and/or LCMs that already comply with U.S. laws and regulations via UL Solutions in accused end products (e.g., TVs, monitors, laptops, tablets, mobile phones) because it allows for such entities to streamline the UL Solutions certification process for such end products if the Heesung TFT-LCD and/or LCMs have already been certified by UL Solutions. <https://marks.ul.com/about/ul-listing-and-classification-marks/appearance-and-significance/marks-for-north-america/>.

57. On information and belief, despite having knowledge of the '706 patent and its infringement, Heesung specifically intended for others to import and sell products accused of

infringing the '706 patent. For example, Heesung specifically intended for its U.S.-based subsidiaries or customers to import and sell products accused of infringing the '706 patent. On information and belief, Heesung instructed and encouraged the importers or customers to import and/or sell products accused of infringing the '706 patent. On information and belief, the purchase and sale agreements between Heesung and the importers or customers provide such instruction and/or encouragement. Further, on information and belief, Heesung's U.S.-based subsidiaries, affiliates, employees, agents, and/or related companies existed for inter alia, the purpose of importing and selling products accused of infringing the '706 patent in the United States.

58. Upon information and belief, despite having knowledge of the '706 patent and knowledge that each was directly and/or indirectly infringing one or more claims of the '706 patent, Heesung nevertheless continued its infringing conduct and disregarded an objectively high likelihood of infringement. Heesung's infringing activities relative to the '706 patent have been willful, wanton, malicious, in bad-faith, deliberate, consciously wrongful, flagrant, and an egregious case of misconduct beyond typical infringement such that Plaintiff is entitled under 35 U.S.C. § 284 to enhanced damages up to three times the amount found or assessed.

59. Plaintiff has been damaged as a result of Defendant's infringing conduct described in this Court. Defendant is, thus, liable to Plaintiff in an amount that adequately compensates Plaintiff for Defendant's infringements, which, by law, cannot be less than a reasonable royalty, together with interest and costs as fixed by this Court under 35 U.S.C. § 284.

60. Plaintiff has complied with the requirements of 35 U.S.C. § 287, to the extent necessary and/or applicable, and is entitled to collect pre- and post-filing damages for Defendant's infringements of the '706 patent.

**COUNT III**  
**(Infringement of U.S. Patent No. 7,583,347)**

61. Plaintiff incorporates paragraphs 1 through 60 herein by reference.

62. This cause of action arises under the patent laws of the United States, and in particular, 35 U.S.C. §§ 271, *et seq.*

63. Plaintiff is the owner of the '347 patent with all substantial rights to the '347 patent including the exclusive right to enforce, sue, and recover damages for past infringement.

64. The '347 patent is valid, enforceable and was duly issued in full compliance with Title 35 of the United States Code.

**DIRECT INFRINGEMENT (35 U.S.C. §271(a))**

65. Heesung has infringed literally, and/or under the Doctrine of Equivalents, one or more claims of the '347 patent in this District and elsewhere in Texas and the United States.

66. Heesung directly infringed the '347 patent via 35 U.S.C. § 271(a) by having made, offered for sale, sold, used, tested, and/or imported those Accused Products, their components and processes, and/or products containing the same that incorporate the fundamental technologies and claims of the '347 patent. For example, Heesung, either by itself and/or via an agent, directly infringed the '347 patent by offering for sale, selling, and/or importing those Accused Products, their components and processes, and/or products containing the same that incorporate the fundamental technologies and claims of the '347 patent, to and/or via its alter egos, agents, intermediaries, distributors, importers, customers, subsidiaries, and/or consumers. Furthermore, on information and belief, Heesung sold and made some Accused Products outside of the United States, delivered those products to its customers, agents, distributors, and/or subsidiaries in the United States, or in the case that it delivered the Accused Products outside of the United States it did so intending and/or knowing that those products were destined for the United States and/or

designed those products for sale in the United States, thereby directly infringing the '347 patent. *See, e.g., Lake Cherokee Hard Drive Techs., L.L.C. v. Marvell Semiconductor, Inc.*, 964 F. Supp. 2d 653, 658 (E.D. Tex. 2013).

67. For example, Heesung infringed claim 1 of the '347 patent. The products accused of infringing the '347 patent comprise a liquid crystal display. For example, LG's TV model no. 49SM8600PUA includes Heesung LCM model no. HC49EQH-SLXA1-211X, which includes an LGD LCD (model no. not identified on device), such that each comprises a liquid crystal display:

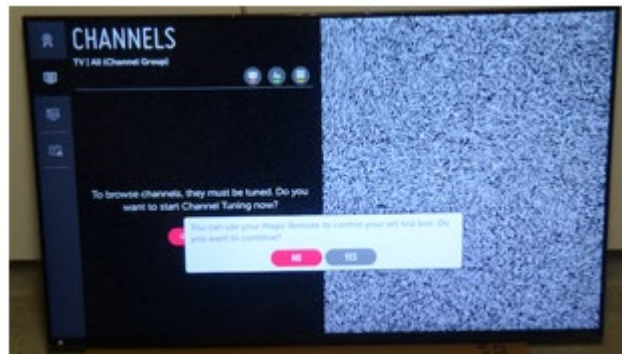

68. The products accused of infringing the '347 patent comprise a liquid crystal panel including an array substrate having an upper surface on which a common electrode, a pixel electrode, a scanning signal line, a video signal line, and a semiconductor switching device are formed, an opposing substrate disposed so as to be opposite to the upper surface of the array substrate, and a liquid crystal layer disposed between the array substrate and the opposing substrate. For example, an examination of LGD's TFT-LCD included in Heesung LCM model no. HC49EQH-SLXA1-211X demonstrates this:

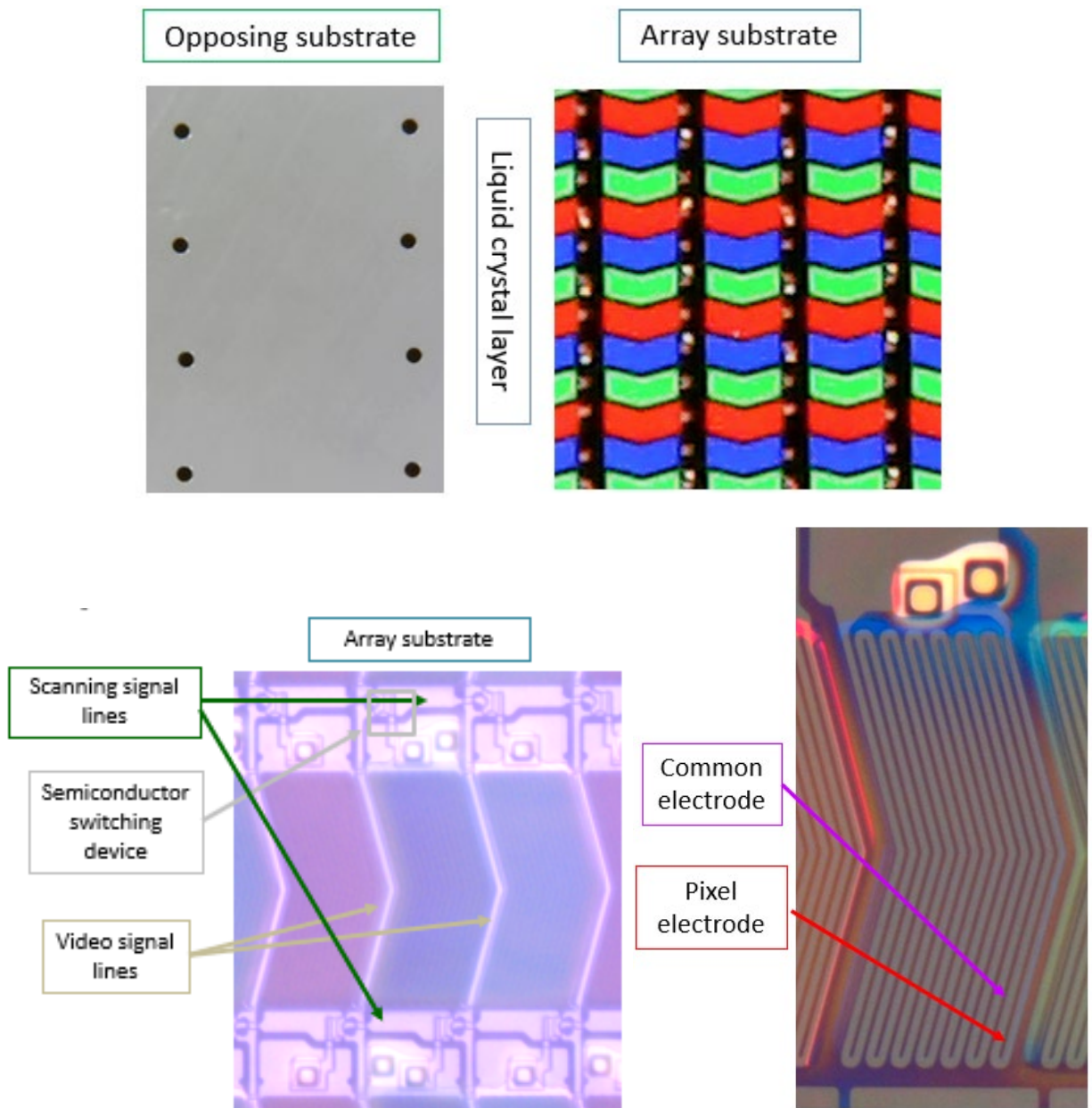

69. The products accused of infringing the '347 patent comprise a reflecting face formed below the liquid crystal panel, wherein a light reflected on the reflecting face is transmitted through the liquid crystal panel. The configuration of the products accused of infringing the '347 patent is such that light reflected on the reflecting face is transmitted through the liquid crystal panel (the reflecting face is beneath the diffuser in the below illustration). For example, an



examination of Heesung LCM model no. HC49EQH-SLXA1-211X, which includes the LGD LCD (model no. not identified on device), demonstrates this:

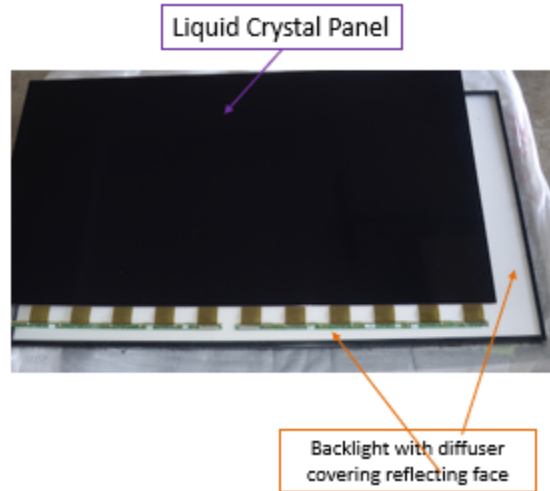

70. The products accused of infringing the '347 patent are configured such that at least one electrode of the common electrode and the pixel electrode is constituted by an electrode portion and a wiring portion. For example, the pixel electrode is constituted by an electrode portion and a wiring portion. For example, an examination of LGD's TFT-LCD included in Heesung LCM model no. HC49EQH-SLXA1-211X demonstrates this:

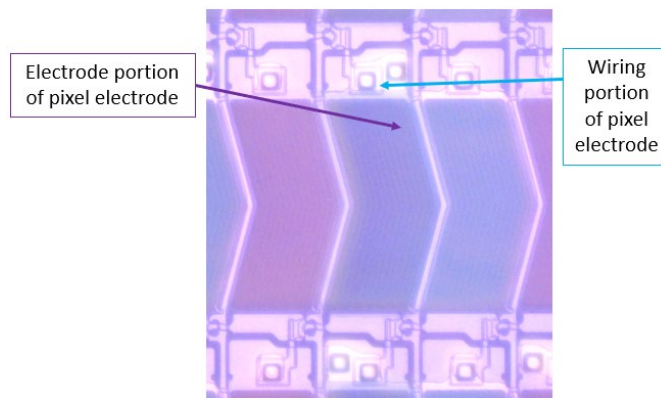

71. The products accused of infringing the '347 patent are configured such that the electrode portion is at least partially constituted by a transparent electric conductor. For example,

the pixel electrode portion is at least partially constituted by a transparent electric conductor. For example, an examination of LGD's TFT-LCD included in Heesung LCM model no. HC49EQH-SLXA1-211X demonstrates this:

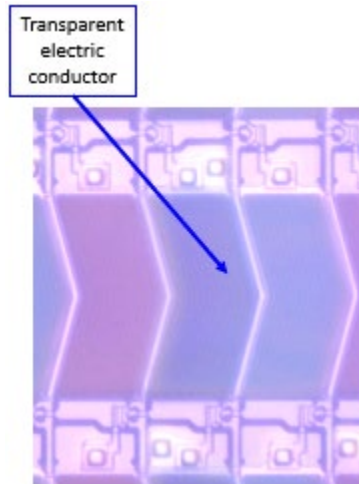

72. The products accused of infringing the '347 patent are configured such that the pixel electrode portion is formed in a layer separated by an insulating layer from a layer in which the scanning signal line is formed, and the pixel wiring portion is formed in the layer in which the scanning signal line is formed. For example, an examination of LGD's TFT-LCD included in Heesung LCM model no. HC49EQH-SLXA1-211X demonstrates this:

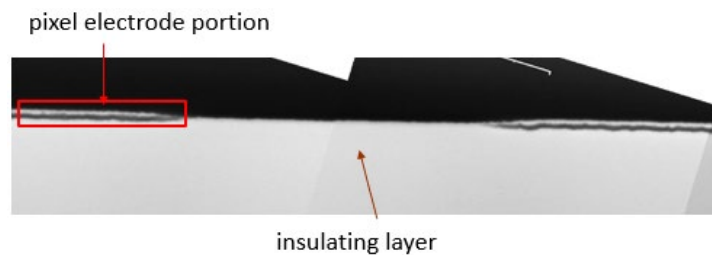

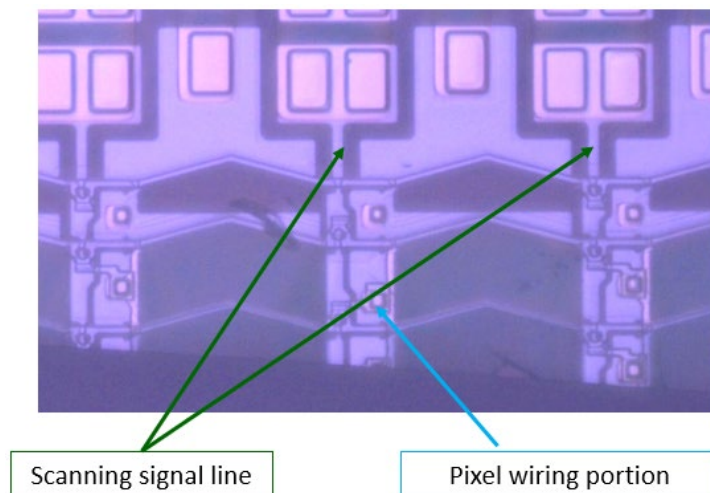

73. At a minimum, LGE, LGEUS, and LGD have known about the '347 patent since at least July 29, 2020, when LGD received notice of their infringement. Furthermore, LGE, LGEUS, and LGD have known about the '347 patent since at least July 29, 2020, when LGE received notice of their infringement. Moreover, Heesung, based on information and belief, was on notice of the '347 patent from at least the foregoing dates as a result of indemnity, contractual, and/or its business relationship with LGE, LGEUS, and/or LGD and did, as a result, receive actual or constructive notice and/or knowledge of the '347 patent. On information and belief, display manufacturers, such as LGE and LGD, once placed on notice of infringement, would, as prudent businesses, provide that same notice to suppliers and component suppliers.<sup>2</sup>

#### **INDIRECT INFRINGEMENT (35 U.S.C. §271(b))**

74. On information and belief, since at least the above-mentioned dates when Heesung was on notice of its infringement, Heesung actively induced, under U.S.C. § 271(b), distributors, retailers, customers, subsidiaries, importers, testing outfits, and/or consumers to directly infringe one or more claims of the '347 patent by making, using, offering for sale, selling, and/or importing the Accused Products. Since at least the notice provided on the above-mentioned dates, Heesung

<sup>2</sup> See FN 1, *supra*.

did so with knowledge, or with willful blindness of the fact, that the induced acts constitute infringement of the '347 patent. Heesung has caused and/or intended to cause, and took affirmative steps to induce infringement by distributors, retailers, customers, subsidiaries, importers, testing outfits, and/or consumers by at least, inter alia, creating advertisements that promote the infringing use of the Accused Products, creating and/or maintaining established distribution channels for the Accused Products into and within the United States, manufacturing the Accused Products in conformity with U.S. laws and regulations, distributing or making available instructions or manuals for these products to purchasers and prospective buyers, testing and certifying features related to infringing features in the Accused Products, and/or providing technical support, replacement parts, or services for these products to these purchasers in the United States. As just one example, Heesung actively induced distributors, retailers, customers, subsidiaries, importers, testing outfits, and/or consumers that have purchased, imported, used, offered for sale, and/or sold Accused Products in the U.S. by marking the Accused Products with UL Solutions labels indicating compliance with U.S. laws and regulations for the Accused Products destined and intended to be sold in the U.S. <https://marks.ul.com/about/ul-listing-and-classification-marks/appearance-and-significance/marks-for-north-america/>. In another example, Heesung actively induced distributors, retailers, customers, subsidiaries, importers, testing outfits, and/or consumers that have purchased, imported, used, offered for sale, and/or sold to include the accused Heesung TFT-LCDs and/or LCMs that already comply with U.S. laws and regulations via UL Solutions in accused end products (e.g., TVs, monitors, laptops, tablets, mobile phones) because it allows for such entities to streamline the UL Solutions certification process for such end products if the Heesung TFT-LCD and/or LCMs have already been certified by UL Solutions.

<https://marks.ul.com/about/ul-listing-and-classification-marks/appearance-and-significance/marks-for-north-america/>.

75. On information and belief, despite having knowledge of the '347 patent and its infringement, Heesung specifically intended for others to import and sell products accused of infringing the '347 patent. For example, Heesung specifically intended for its U.S.-based subsidiaries or customers to import and sell products accused of infringing the '347 patent. On information and belief, Heesung instructed and encouraged the importers or customers to import and/or sell products accused of infringing the '347 patent. On information and belief, the purchase and sale agreements between Heesung and the importers or customers provide such instruction and/or encouragement. Further, on information and belief, Heesung's U.S.-based subsidiaries, affiliates, employees, agents, and/or related companies existed for inter alia, the purpose of importing and selling products accused of infringing the '347 patent in the United States.

76. Upon information and belief, despite having knowledge of the '347 patent and knowledge that each was directly and/or indirectly infringing one or more claims of the '347 patent, Heesung nevertheless continued its infringing conduct and disregarded an objectively high likelihood of infringement. Heesung's infringing activities relative to the '347 patent have been willful, wanton, malicious, in bad-faith, deliberate, consciously wrongful, flagrant, and an egregious case of misconduct beyond typical infringement such that Plaintiff is entitled under 35 U.S.C. § 284 to enhanced damages up to three times the amount found or assessed.

77. Plaintiff has been damaged as a result of Defendant's infringing conduct described in this Court. Defendant is, thus, liable to Plaintiff in an amount that adequately compensates Plaintiff for Defendant's infringements, which, by law, cannot be less than a reasonable royalty, together with interest and costs as fixed by this Court under 35 U.S.C. § 284.

78. Plaintiff has complied with the requirements of 35 U.S.C. § 287, to the extent necessary and/or applicable, and is entitled to collect pre- and post-filing damages for Defendant's infringements of the '347 patent.

**COUNT IV**  
**(Infringement of U.S. Patent No. 7,414,682)**

79. Plaintiff incorporates paragraphs 1 through 78 herein by reference.

80. This cause of action arises under the patent laws of the United States, and in particular, 35 U.S.C. §§ 271, *et seq.*

81. Plaintiff is the owner of the '682 patent with all substantial rights to the '682 patent including the exclusive right to enforce, sue, and recover damages for past infringement.

82. The '682 patent is valid, enforceable and was duly issued in full compliance with Title 35 of the United States Code.

**DIRECT INFRINGEMENT (35 U.S.C. §271(a))**

83. Heesung has infringed literally, and/or under the Doctrine of Equivalents, one or more claims of the '682 patent in this District and elsewhere in Texas and the United States.

84. Heesung directly infringed the '682 patent via 35 U.S.C. § 271(a) by having made, offered for sale, sold, used, tested, and/or imported those Accused Products, their components and processes, and/or products containing the same that incorporate the fundamental technologies and claims of the '682 patent. For example, Heesung, either by itself and/or via an agent, directly infringed the '682 patent by offering for sale, selling, and/or importing those Accused Products, their components and processes, and/or products containing the same that incorporate the fundamental technologies and claims of the '682 patent, to and/or via its alter egos, agents, intermediaries, distributors, importers, customers, subsidiaries, and/or consumers. Furthermore, on information and belief, Heesung sold and made some Accused Products outside of the United

States, delivered those products to its customers, agents, distributors, and/or subsidiaries in the United States, or in the case that it delivered the Accused Products outside of the United States it did so intending and/or knowing that those products were destined for the United States and/or designed those products for sale in the United States, thereby directly infringing the '682 patent. *See, e.g., Lake Cherokee Hard Drive Techs., L.L.C. v. Marvell Semiconductor, Inc.*, 964 F. Supp. 2d 653, 658 (E.D. Tex. 2013).

85. Heesung infringed claim 7 of the '682 patent. The products accused of infringing the '682 patent comprise a liquid crystal display of transversal electric field type. For example, LG's TV model no. 49SM8600PUA includes Heesung LCM model no. HC49EQH-SLXA1-211X, which includes an LGD LCD (model no. not identified on device), such that each comprises a liquid crystal display of transversal electric field type:

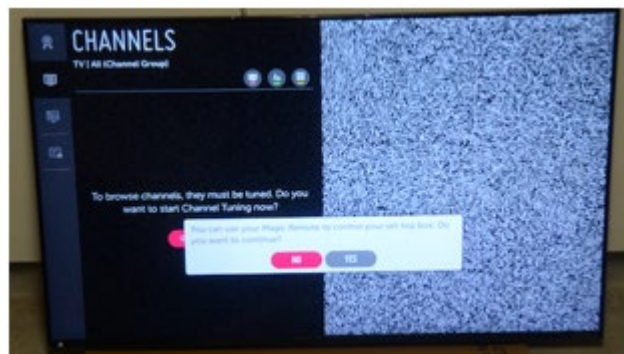

86. The products accused of infringing the '682 patent comprise a liquid crystal panel in which liquid crystal is retained between a pair of substrates. For example, an examination of

LGD's TFT-LCD included in Heesung LCM model no. HC49EQH-SLXA1-211X demonstrates this:

Liquid crystal panel

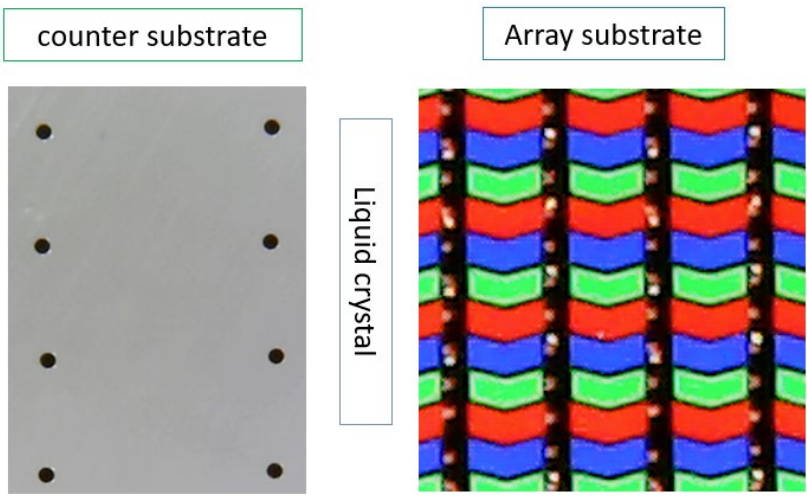

87. The products accused of infringing the '682 patent comprise a plurality of scanning signal lines and a plurality of video signal lines formed so as to define a plurality of pixels in a matrix on an inner surface of one of the pair of substrates. For example, an examination of LGD's TFT-LCD included in Heesung LCM model no. HC49EQH-SLXA1-211X demonstrates this:



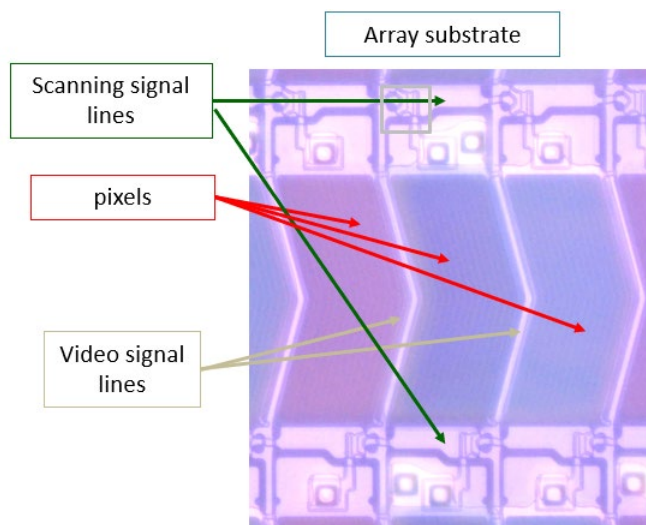

88. The products accused of infringing the '682 patent comprise a pixel electrode and a common electrode formed opposite to each other in each pixel in a plan view. For example, an examination of LGD's TFT-LCD included in Heesung LCM model no. HC49EQH-SLXA1-211X demonstrates this:

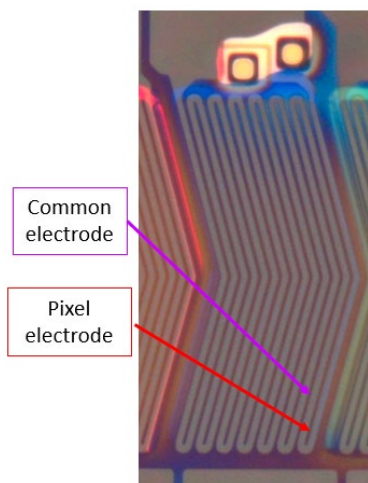

89. The products accused of infringing the '682 patent are configured such that an image is displayed on the liquid crystal panel by inputting a video signal from the video signal line into the pixel electrode while sequentially selecting the pixel through the scanning signal line. For

example, an examination of LGD's TFT-LCD included in Heesung LCM model no. HC49EQH-SLXA1-211X demonstrates this:

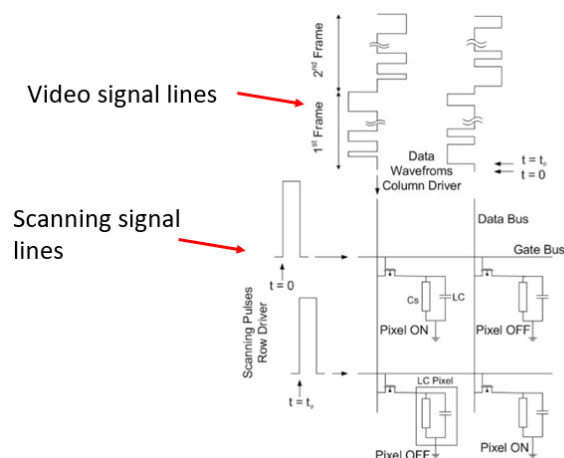
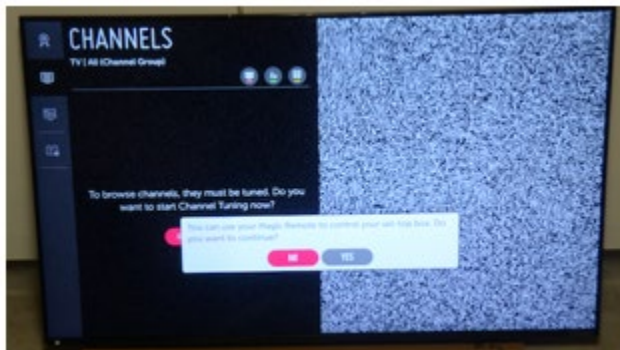

<https://www.intechopen.com/books/new-developments-in-liquid-crystals/active-matrix-liquid-crystal-displays-operation-electronics-and-analog-circuits-design>

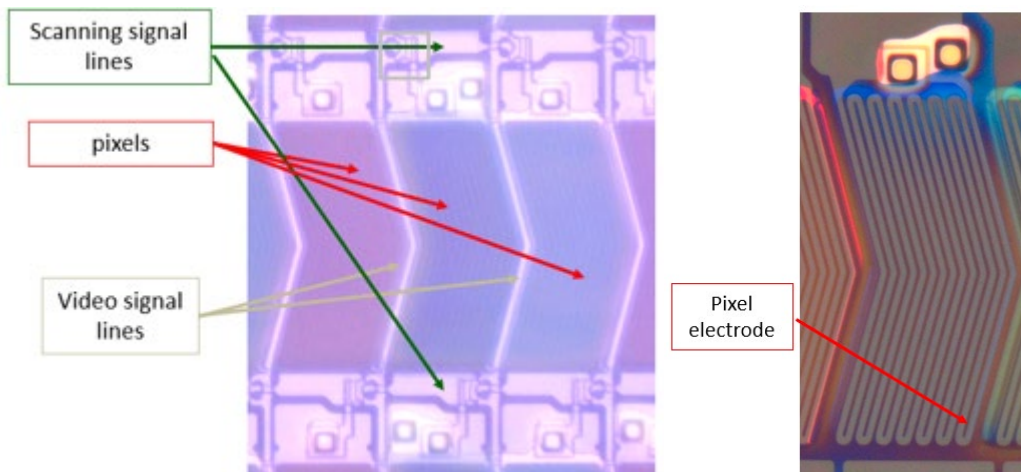

90. The products accused of infringing the '682 patent are configured such that at least one of the scanning signal lines, the video signal lines, the pixel electrode, or the common electrode is at least partially constituted by a light-transmitting conductive layer and a light-non-transmitting conductive layer. For example, an examination of LGD's TFT-LCD included in Heesung LCM model no. HC49EQH-SLXA1-211X demonstrates that the pixel electrode is at least partially constituted by a light-transmitting conductive layer and a light-non-transmitting conductive layer:

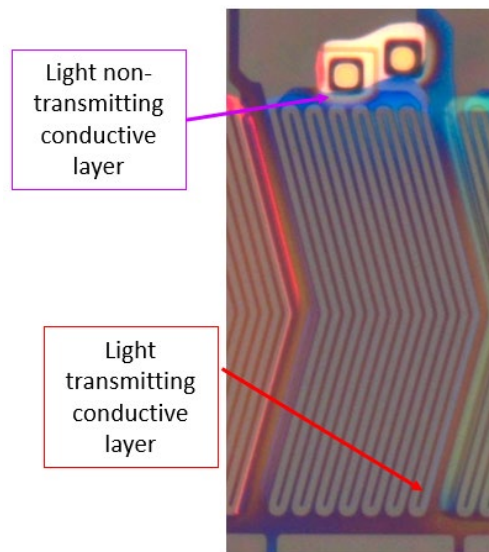

91. The products accused of infringing the '682 patent are configured such that a width of the light-transmitting conductive layer is wider than a width of the light-non-transmitting layer. For example, an examination of LGD's TFT-LCD included in Heesung LCM model no. HC49EQH-SLXA1-211X demonstrates this:

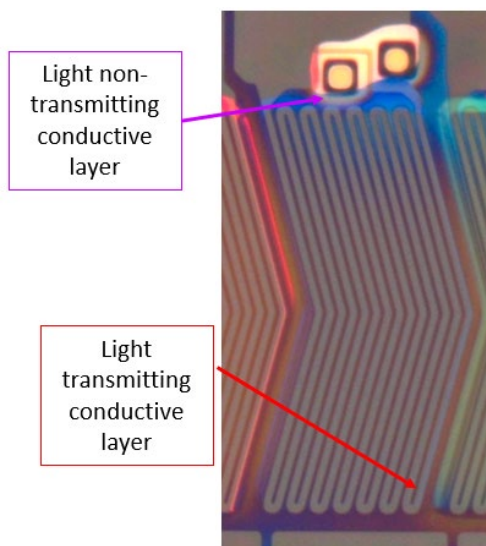

92. At a minimum, LGE, LGEUS, and LGD have known about the '682 patent since at least February 8, 2017, when LGD received notice of their infringement from a former patent owner Godo Kaisha IP Bridge 1, and at least by March 7, 2017 when LGD replied to the notice letter. In addition, LGE, LGEUS, and LGD have known about the '682 patent since at least July 29, 2020, when LGD again received notice of their infringement. Furthermore, LGE, LGEUS, and LGD have known about the '682 patent since at least July 29, 2020, when LGE received notice of their infringement. Moreover, Heesung, based on information and belief, was on notice of the '682 patent from at least the foregoing dates as a result of indemnity, contractual, and/or its business relationship with LGE, LGEUS, and/or LGD and did, as a result, receive actual or constructive notice and/or knowledge of the '682 patent. On information and belief, display manufacturers, such as LGE and LGD, once placed on notice of infringement, would, as prudent businesses, provide that same notice to suppliers and component suppliers.<sup>3</sup>

---

<sup>3</sup> See FN 1, *supra*.

**INDIRECT INFRINGEMENT (35 U.S.C. §271(b))**

93. On information and belief, since at least the above-mentioned dates when Heesung was on notice of its infringement, Heesung actively induced, under U.S.C. § 271(b), distributors, retailers, customers, subsidiaries, importers, testing outfits, and/or consumers to directly infringe one or more claims of the '682 patent by making, using, offering for sale, selling, and/or importing the Accused Products. Since at least the notice provided on the above-mentioned dates, Heesung did so with knowledge, or with willful blindness of the fact, that the induced acts constitute infringement of the '682 patent. Heesung has caused and/or intended to cause, and took affirmative steps to induce infringement by distributors, retailers, customers, subsidiaries, importers, testing outfits, and/or consumers by at least, inter alia, creating advertisements that promote the infringing use of the Accused Products, creating and/or maintaining established distribution channels for the Accused Products into and within the United States, manufacturing the Accused Products in conformity with U.S. laws and regulations, distributing or making available instructions or manuals for these products to purchasers and prospective buyers, testing and certifying features related to infringing features in the Accused Products, and/or providing technical support, replacement parts, or services for these products to these purchasers in the United States. As just one example, Heesung actively induced distributors, retailers, customers, subsidiaries, importers, testing outfits, and/or consumers that have purchased, imported, used, offered for sale, and/or sold Accused Products in the U.S. by marking the Accused Products with UL Solutions labels indicating compliance with U.S. laws and regulations for the Accused Products destined and intended to be sold in the U.S. <https://marks.ul.com/about/ul-listing-and-classification-marks/appearance-and-significance/marks-for-north-america/>. In another example, Heesung actively induced distributors, retailers, customers, subsidiaries, importers, testing outfits, and/or

consumers that have purchased, imported, used, offered for sale, and/or sold to include the accused Heesung TFT-LCDs and/or LCMs that already comply with U.S. laws and regulations via UL Solutions in accused end products (e.g., TVs, monitors, laptops, tablets, mobile phones) because it allows for such entities to streamline the UL Solutions certification process for such end products if the Heesung TFT-LCD and/or LCMs have already been certified by UL Solutions. <https://marks.ul.com/about/ul-listing-and-classification-marks/appearance-and-significance/marks-for-north-america/>.

94. On information and belief, despite having knowledge of the '682 patent and its infringement, Heesung specifically intended for others to import and sell products accused of infringing the '682 patent. For example, Heesung specifically intended for its U.S.-based subsidiaries or customers to import and sell products accused of infringing the '682 patent. On information and belief, Heesung instructed and encouraged the importers or customers to import and/or sell products accused of infringing the '682 patent. On information and belief, the purchase and sale agreements between Heesung and the importers or customers provide such instruction and/or encouragement. Further, on information and belief, Heesung's U.S.-based subsidiaries, affiliates, employees, agents, and/or related companies existed for inter alia, the purpose of importing and selling products accused of infringing the '682 patent in the United States.

95. Upon information and belief, despite having knowledge of the '682 patent and knowledge that each was directly and/or indirectly infringing one or more claims of the '682 patent, Heesung nevertheless continued its infringing conduct and disregarded an objectively high likelihood of infringement. Heesung's infringing activities relative to the '682 patent have been willful, wanton, malicious, in bad-faith, deliberate, consciously wrongful, flagrant, and an

egregious case of misconduct beyond typical infringement such that Plaintiff is entitled under 35 U.S.C. § 284 to enhanced damages up to three times the amount found or assessed.

96. Plaintiff has been damaged as a result of Defendant's infringing conduct described in this Court. Defendant is, thus, liable to Plaintiff in an amount that adequately compensates Plaintiff for Defendant's infringements, which, by law, cannot be less than a reasonable royalty, together with interest and costs as fixed by this Court under 35 U.S.C. § 284.

97. Plaintiff has complied with the requirements of 35 U.S.C. § 287, to the extent necessary and/or applicable, and is entitled to collect pre- and post-filing damages for Defendant's infringements of the '682 patent.

### **CONCLUSION**

98. Plaintiff is entitled to recover from Defendant the damages sustained by Plaintiff as a result of the Defendant's wrongful acts in an amount subject to proof at trial, which, by law, cannot be less than a reasonable royalty, together with interest and costs as fixed by this Court.

99. Plaintiff has incurred and will incur attorneys' fees, costs, and expenses in the prosecution of this action. The circumstances of this dispute may give rise to an exceptional case within the meaning of 35 U.S.C. § 285, and Plaintiff is entitled to recover its reasonable and necessary attorneys' fees, costs, and expenses.

### **JURY DEMAND**

Plaintiff requests a trial by jury pursuant to Rule 38 of the Federal Rules of Civil Procedure.

### **PRAYER FOR RELIEF**

Plaintiff asks that the Court find in its favor and against Defendant and that the Court grant Plaintiff the following relief:

1. A judgment that Defendant has infringed the Asserted Patents as alleged herein, directly and/or indirectly by way of inducing infringement of such patents;
2. A judgment for an accounting of all damages sustained by Plaintiff as a result of the acts of infringement by Defendant;
3. A judgment and order requiring Defendant to pay Plaintiff damages under 35 U.S.C. § 284, including up to treble damages as provided by 35 U.S.C. § 284, and any royalties determined to be appropriate;
4. A judgment and order requiring Defendant to pay Plaintiff pre-judgment and post-judgment interest on the damages awarded;
5. A judgment and order finding this to be an exceptional case and requiring Defendant to pay the costs of this action (including all disbursements) and attorneys' fees as provided by 35 U.S.C. § 285; and
6. Such other and further relief as the Court deems just and equitable.



Dated: February 8, 2024

Respectfully submitted,

/s/ Patrick J. Conroy

Patrick J. Conroy

Texas Bar No. 24012448

Justin Kimble

Texas Bar No. 24036909

T. William Kennedy Jr.

Texas Bar No. 24055771

Jon Rastegar

Texas Bar No. 24064043

**Nelson Bumgardner Conroy PC**

2727 North Harwood Street

Suite 250

Dallas, TX 75201

Tel: (214) 446-4950

pat@nelbum.com

justin@nelbum.com

bill@nelbum.com

jon@nelbum.com

John P. Murphy

Texas Bar No. 24056024

**Nelson Bumgardner Conroy PC**

3131 W 7th St

Suite 300

Fort Worth, TX 76107

Tel: (817) 806-3808

murphy@nelbum.com

Attorneys for Plaintiff

**BISHOP DISPLAY TECH LLC**