

**IN THE UNITED STATES DISTRICT COURT
FOR THE EASTERN DISTRICT OF TEXAS
MARSHALL DIVISION**

LONGHORN AUTOMOTIVE GROUP LLC,

Plaintiff,

v.

VOLVO CAR CORPORATION and AB
VOLVO,

Defendants.

Case No. 2:24-cv-

JURY TRIAL DEMANDED

COMPLAINT FOR PATENT INFRINGEMENT

Plaintiff Longhorn Automotive Group LLC (“LAG” or “Plaintiff”) for its Complaint for patent infringement against Defendants Volvo Car Corporation (“Volvo Car”) and AB Volvo (“AB Volvo”) (collectively, “Volvo” or “Defendants”) alleges as follows:

THE PARTIES

1. LAG is a limited liability company organized and existing under the laws of the State of Texas, with its principal place of business located at 104 E. Houston Street, Marshall, Texas 75670.

2. Upon information and belief, Defendant Volvo Car is a Swedish corporation with its principal place of business located at VAK Building, Assar Gabrielssons väg, Göteborg , SE-405 31, Sweden. Volvo is one of the largest car manufacturers and sellers in the world and in the United States. Upon information and belief, Volvo Car does business in Texas and in the Eastern District of Texas, directly or through intermediaries.

3. Upon information and belief, Defendant AB Volvo (“AB Volvo”) is a Swedish company with its principal place of business located at Gropegårdsgatan 2, 417 10 Göteborg,

Sweden. Upon information and belief, AB Volvo manufactures, imports, and distributes of Volvo and Mack-branded vehicles. Upon information and belief, AB Volvo manufactures and assembles, both in the United States and internationally, Volvo and Mack-branded vehicles. Upon information and belief, AB Volvo does business in Texas and in the Eastern District of Texas, directly or through intermediaries.

JURISDICTION

4. This is an action for patent infringement arising under the patent laws of the United States, 35 U.S.C. §§ 1, *et seq.* This Court has jurisdiction over this action pursuant to 28 U.S.C. §§ 1331 and 1338(a).

5. This Court has personal jurisdiction over Defendants. Defendants regularly conducts business and has committed acts of patent infringement and/or has induced acts of patent infringement by others in this Judicial District and/or has contributed to patent infringement by others in this Judicial District, the State of Texas, and elsewhere in the United States.

6. Venue is proper in this Judicial District pursuant to 28 U.S.C. § 1391 because, among other things, Defendants are not residents in the United States, and thus may be sued in any judicial district pursuant to 28 U.S.C. § 1391(c)(3).

7. Defendants are subject to this Court's jurisdiction pursuant to due process and/or the Texas Long Arm Statute due at least to their substantial business in this State and Judicial District, including (a) at least part of its past infringing activities, (b) regularly doing or soliciting business in Texas, and/or (c) engaging in persistent conduct and/or deriving substantial revenue from goods and services provided to customers in Texas.

PATENTS-IN-SUIT

8. On August 19, 2014, the United States Patent and Trademark Office duly and legally issued U.S. Patent No. 8,810,803 (the “’803 Patent”) entitled “Lens System”. A true and correct copy of the ’803 Patent is available at: <https://patentimages.storage.googleapis.com/b8/ee/03/9912346a786072/US8810803.pdf>.

9. On July 26, 2011, the United States Patent and Trademark Office duly and legally issued U.S. Patent No. 7,987,002 (the “’002 Patent”) entitled “Arrangement for Distributed Measurement System for Measurement and Simulation in Distributed Control Systems”. A true and correct copy of the ’002 Patent is available at: <https://patentimages.storage.googleapis.com/2e/7c/c3/eaf362f9a8faf3/US7987002.pdf>.

10. On April 7, 2009, the United States Patent and Trademark Office duly and legally issued U.S. Patent No. 7,513,238 (the “’238 Patent”) entitled “Directly Injecting Internal Combustion Engine.” A true and correct copy of the ’238 Patent is available at: <https://patentimages.storage.googleapis.com/23/6c/e0/5d3e6ec82760c9/US7513238.pdf>.

11. On September 11, 2012, the United States Patent and Trademark Office duly and legally issued U.S. Patent No. 8,265,353 (the “’353 Patent”) entitled “Method of Reconstructing an Image Acquired Using Several Imagery Modes.” A true and correct copy of the ’353 Patent is available at: <https://patentimages.storage.googleapis.com/c3/ee/14/9676306bcc9887/US8265353.pdf>.

12. On December 27, 2011, the United States Patent and Trademark Office duly and legally issued U.S. Patent No. 8,085,192 (the “’192 Patent”) entitled “Device, System and Method for Controlling and Storing Sensitive Information on a GPS Device”. A true and correct copy of the ’192 Patent is available at: <https://patentimages.storage.googleapis.com/55/8f/0d/14facb235e78ec/US8085192.pdf>.

13. LAG is the sole and exclusive owner of all right, title, and interest in the '803 Patent, the '002 Patent, the '238 Patent, the '353 Patent, and the '192 Patent (collectively, the "Patents-in-Suit") and holds the exclusive right to take all actions necessary to enforce its rights to the Patents-in-Suit, including the filing of this patent infringement lawsuit. LAG also has the right to recover all damages for past, present, and future infringement of the Patents-in-Suit and to seek injunctive relief as appropriate under the law.

14. LAG has at all times complied with the marking provisions of 35 U.S.C. § 287 with respect to the Patents-in-Suit.

FACTUAL ALLEGATIONS

15. The '803 Patent generally relates to a plurality of lenses used for focusing and projecting the light in plurality of directions. Such patterns include those generated by systems from an emitted light source. These patterns may be analyzed by computers to identify and determine aspects of the light patterns. The technology described in the '803 Patent was developed by inventor Matt Bell. For example, this technology is implemented in Volvo's headlight systems included in personal vehicles, in all trims and configurations, such as the EX90, C40 Recharge, XC40 Recharge, EX30, EX 90 Recharge, XC60 Recharge, XC90, XC60, XC40, S90 Recharge, S60 Recharge, S90, S60, V60 Recharge, V90 Cross Country, V60 Cross Country, VNR 300, VNR 400, VNR 640, VNR 660, VNL 300, VNL 400, VNL 740, VNL 760, VNL 860, VNX 300, VNX 400, VNX 740, VHD 300 AB, VHD 300 AF, VHD 400 AB, VHD 400 AF, VAH 300, VAH 400, and VAH 600, among other vehicles (collectively, the "Accused Vehicles").

16. The '002 Patent generally relates to a monitoring system with plurality of monitoring units communicating with a first interface in a first protocol which in turn is connected to a distributed control systems using a second protocol. The technology described in the '002

Patent was developed by inventor Lars-Berno Fredriksson. For example, this technology is implemented in Vol Cars App system, and all previous versions and iterations, included with personal vehicles, in all trims and configurations, including the Accused Vehicles.

17. The '238 Patent generally relates to novel direct injection in internal combustion engines where the shapes of the piston allow for early or late injection to optimize the direct injection. The technology described in the '238 Patent was developed by inventors Ruediger Pfaff, Martin Schnabel, and Joachim Suess at Daimler AG. For example, this technology is implemented in Volvo internal combustion engines included in Volvo vehicles, in all trims and configurations, including certain Accused Vehicles.

18. The '353 Patent generally relates to measuring a mobile object using a plurality of imaging techniques in synchronization to provide video images of an object's state. The technology described in the '353 Patent was developed by Stéphane Bonnet and Pierre Grangeat. For example, this technology is implemented in Volvo's driver assistance systems, including IntelliSafe Assist, and all previous versions and iterations, in all trims and configurations, including the Accused Vehicles.

19. Volvo has infringed and is continuing to infringe the Patents-in-Suit by one or more of making, using, selling, offering to sell, and/or importing, and by actively inducing others to make, use, sell, offer to sell, and/or importing commercial and personal vehicles (including, but not limited to, commercial and personal vehicles), which are used or tested by Volvo and its direct or indirect customers or users in the United States.

COUNT I
(Infringement of the '803 Patent)

20. Paragraphs 1 through 18 are incorporated by reference as if fully set forth herein.

21. LAG has not licensed or otherwise authorized Defendants to make, use, offer for

sale, sell, or import any products that embody the inventions of the '803 Patent.

22. Defendants have and continue to directly infringe the '803 Patent, either literally or under the doctrine of equivalents, without authority and in violation of 35 U.S.C. § 271, by one or more of making, using, offering to sell, selling, and/or importing into the United States products that satisfy each and every limitation of one or more claims of the '803 Patent. Such products include, but are not limited to, Volvo's headlight system, included in personal vehicles, in all trims and configurations, such as the Volvo XC60, among other vehicles.

23. For example, Defendants have and continue to directly infringe at least claim 15 of the '803 Patent by making, using, offering to sell, selling, and/or importing the Accused Vehicles into the United States that include LED headlights, or equivalent thereof, such as the Volvo XC60, among other products.

24. The Volvo XC60 comprises a system for projecting a pattern of light (e.g., through incorporation LED Headlights):

Lighting control

Updated 03/22/2023

The different lighting controls are used to control both exterior and interior lighting. The left-hand stalk switch activates and adjusts the exterior lighting. You can both activate and adjust the exterior and interior lighting via the centre display.



¹ <https://www.volvocars.com/en-th/support/car/xc60/article/cbe5f6a89224f644c0a80151088cb4cc>.

Active Bending Lights*

Updated 2023-03-22

Active Bending Lights (ABL) are designed to help provide extra illumination in curves and intersections. Depending on equipment level, vehicles with LED^[1] headlights* may be equipped with Active Bending Lights.

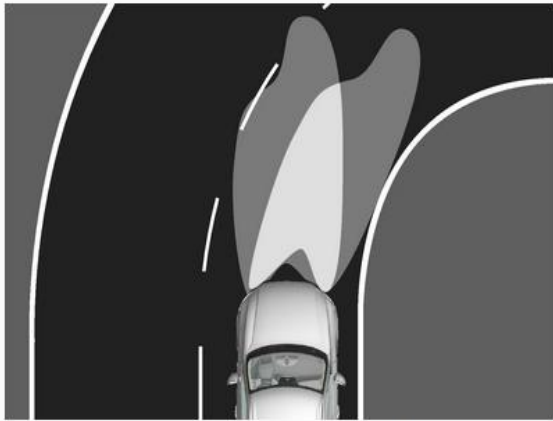

Headlight pattern without Active Bending Lights (left), and with (right).

2

² <https://www.volvocars.com/en-ca/support/car/xc60/article/dfd5d5bd9b0dd7dfc0a8015108eaf009>.

Active main beam

Updated 03/22/2023

Active main beam uses the camera sensor in the upper edge of the windscreen. The camera sensor registers the headlamp beams from oncoming traffic or the rear lights of vehicles ahead, and then switches from main beam to dipped beam.



³

25. The Volvo XC60 comprises a light source (e.g., the LED lights) including a plurality of emitters configured to emit light:

³ <https://www.volvocars.com/en-th/support/car/xc60/article/49650512961fc833c0a8015115586acb>.

Active Bending Lights *

Updated 2023-03-22

Active Bending Lights (ABL) are designed to help provide extra illumination in curves and intersections. Depending on equipment level, vehicles with LED^[1] headlights* may be equipped with Active Bending Lights.

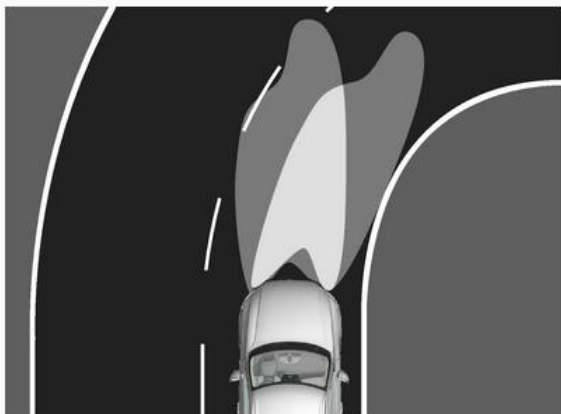

Headlight pattern without Active Bending Lights (left), and with (right).

4

26. The Volvo XC60 comprises a cluster of lenses (e.g., combination of different lights in each headlight), each lens included in the cluster of lenses being configured to receive the emitted light from each of the plurality of emitters:

Adaptive functionality*

The active main beam has adaptive functionality^[1]. In this case, unlike what happens during conventional dimming, the light beam continues to illuminate with main beam on both sides of oncoming traffic or vehicles ahead – only the part of the light beam that points directly to the vehicle is dimmed.

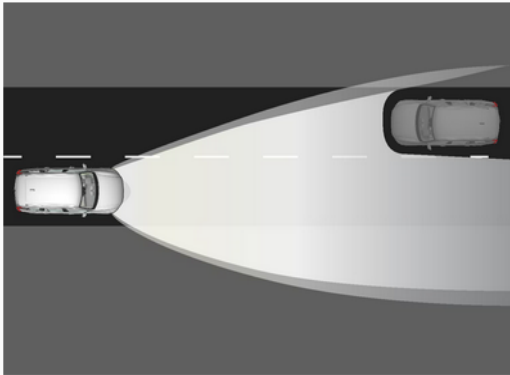

Adaptive functionality: Dipped beam directly towards oncoming vehicle, but continued main beam on both sides of the vehicle.

5

⁵ <https://www.volvocars.com/en-th/support/car/xc60/article/49650512961fc833c0a8015115586acb>.

Lighting control

Updated 03/22/2023

The different lighting controls are used to control both exterior and interior lighting. The left-hand stalk switch activates and adjusts the exterior lighting. You can both activate and adjust the exterior and interior lighting via the centre display.



⁶

27. The Volvo XC60 comprises a condenser lens (e.g., a primary optic mirror) located between said light source (e.g., LEDs) and said cluster of lenses, the condenser lens (e.g., outer lenses) concentrating light from each of the plurality of emitters towards a center of the cluster of lenses:

⁶ <https://www.volvocars.com/en-th/support/car/xc60/article/cbe5f6a89224f644c0a80151088cb4cc>.

Active main beam

Updated 03/22/2023

Active main beam uses the camera sensor in the upper edge of the windscreen. The camera sensor registers the headlamp beams from oncoming traffic or the rear lights of vehicles ahead, and then switches from main beam to dipped beam.



7

⁷ <https://www.volvocars.com/en-th/support/car/xc60/article/49650512961fc833c0a8015115586acb>.

Lighting control

Updated 03/22/2023

The different lighting controls are used to control both exterior and interior lighting. The left-hand stalk switch activates and adjusts the exterior lighting. You can both activate and adjust the exterior and interior lighting via the centre display.



8

28. Defendants have and continue to indirectly infringe one or more claims of the '803 Patent by knowingly and intentionally inducing others, including Volvo customers and end-users, to directly infringe, either literally or under the doctrine of equivalents, by making, using, offering to sell, selling, and/or importing into the United States products that include infringing technology.

29. Defendants, with knowledge that these products, or the use thereof, infringe the '803 Patent at least as of the date of this Complaint, knowingly and intentionally induced, and continue to knowingly and intentionally induce, direct infringement of the '803 Patent by providing these products to customers and end-users for use in an infringing manner. Alternatively, on information and belief, Defendants have adopted a policy of not reviewing the

⁸ <https://www.volvocars.com/en-th/support/car/xc60/article/cbe5f6a89224f644c0a80151088cb4cc>.

patents of others, including specifically those related to Defendants' specific industry, thereby remaining willfully blind to the Patent-in-Suit at least as early as the issuance of the Patent-in-Suit.

30. Defendants have and continue to induce infringement by others, including customers and end-users, with the intent to cause infringing acts by others or, in the alternative, with the belief that there was a high probability that others, including end-users, infringe the '803 Patent, but while remaining willfully blind to the infringement. Defendants have and continue to induce infringement by its customers and end-users by supplying them with instructions on how to operate the infringing technology in an infringing manner, while also making publicly available information on the infringing technology via Defendants' websites, product literature and packaging, and other publications.⁹

31. LAG has suffered damages as a result of Defendants' direct and indirect infringement of the '803 Patent in an amount to be proved at trial.

32. LAG has suffered, and will continue to suffer, irreparable harm as a result of Defendants' infringement of the '803 Patent, for which there is no adequate remedy at law, unless Defendants' infringement is enjoined by this Court.

COUNT II
(Infringement of the '002 Patent)

33. Paragraphs 1 through 18 are incorporated by reference as if fully set forth herein.

34. LAG has not licensed or otherwise authorized Defendants to make, use, offer for sale, sell, or import any products that embody the inventions of the '002 Patent.

35. Defendants have and continue to infringe the '002 Patent, either literally or under the doctrine of equivalents, without authority and in violation of 35 U.S.C. § 271, by one or more

⁹ See Volvo XC60 Owner's Manual and other materials, available at: <https://volvo.custhelp.com/app/manuals/ownersmanualinfo>.

of making, using, offering to sell, selling, and/or importing into the United States products that satisfy each and every limitation of one or more claims of the '002 Patent. Such products include, but are not limited to, Volvo Cars App, included in vehicles, in all trims and configurations, including the Accused Vehicles, such as the Volvo XC40.

36. For example, Defendants have and continue to directly infringe at least Claim 15 of the '002 Patent by making, using, offering to sell, selling, and/or importing into the United States products that include Volvo Cars App, such as the Volvo XC40, among other vehicles.

37. The Volvo XC40 comprises a monitoring system (e.g., through the implementation of the Volvo Cars App either Ericsson Connected Vehicle Cloud servers):

What is the Volvo Cars app? 

The Volvo Cars app is a service that simplifies your everyday life and helps you get more from your Volvo. Content and functions are optimized for your particular car and services. The app offers information, manuals, support, service booking and for the connected car, car status and remote control of useful vehicle functions.

10

What is included in the Volvo Cars app? 

The Volvo Cars app includes information and manuals for your car, support when you need it and shortcuts for service booking. For those with a connected car/Volvo Cars subscription, a range of remote services is also available. Please note that app content and functionality depend on your car and the services available in your area. Your Volvo retailer can provide more details.

11

Is the Volvo Cars app replacing the Volvo On Call app? 

Yes, the Volvo On Call app has changed name and is now called the Volvo Cars app. The app is continuously being developed and refined and we will add many exciting and useful functions and content as this happens.

12

¹⁰ <https://www.volvocars.com/us/v/volvo-cars-app>.

¹¹ *Id.*

¹² *Id.*



13

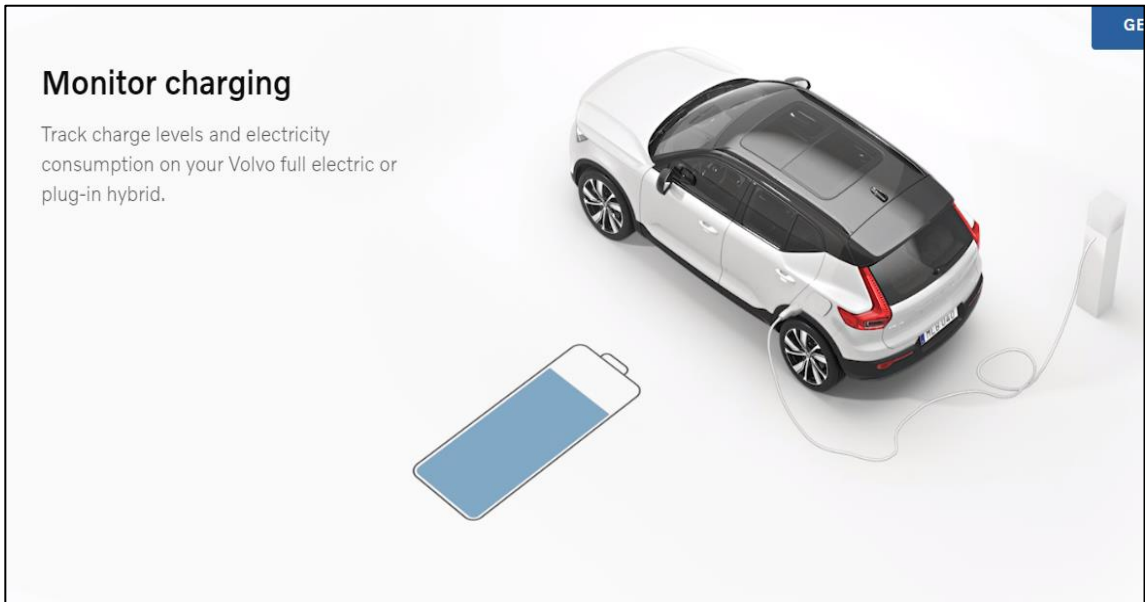

14

¹³ <https://www.youtube.com/watch?v=v9tvnLZoxMk&t=16s>.

¹⁴ <https://www.volvocars.com/us/v/volvo-cars-app>.



Control interior climate

Remotely start, stop or set a timer for pre-heating and cooling.

15

Lock and unlock

Use your phone to remotely lock and unlock your Volvo and enjoy increased security.



16

¹⁵ *Id.*

¹⁶ *Id.*

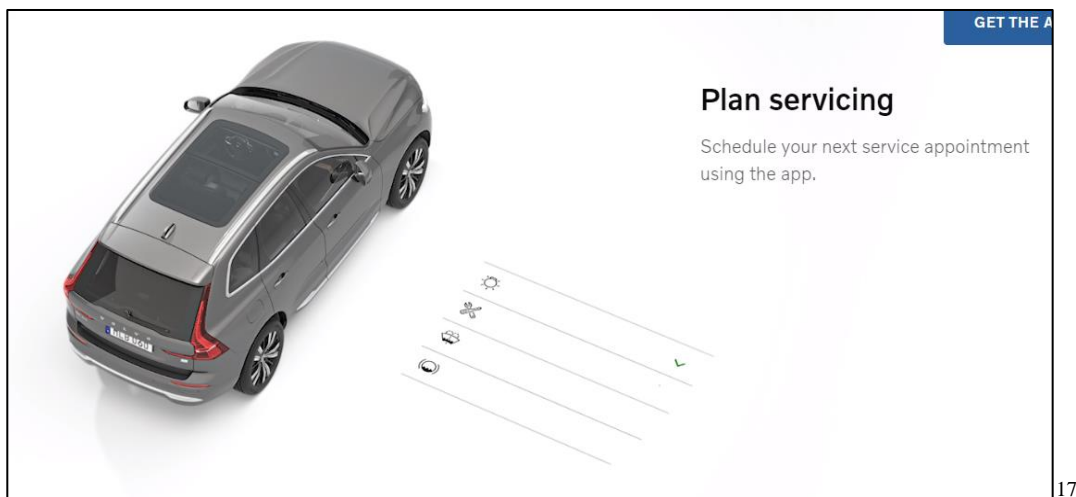

38. The Volvo XC40 comprises a plurality of monitoring units (e.g., the Volvo Cars App with Ericsson Connected Vehicle Cloud server) configured to communicate with at least one interface unit (e.g., the telematics control unit (TCU)) using a first protocol (e.g., a cellular network), wherein the at least one interface unit is communicably connected to a distributed control system (e.g., the vehicle's electronic control modules (ECUs), such as the Body Control Module (BCM) or Engine Control Module (ECM)), and the at least one interface unit is further configured to receive data values from the distributed control system using a second protocol (e.g., CAN communication):

Ericsson (NASDAQ: ERIC) has been selected by Volvo Car Group (Volvo Cars) to provide the industrialized Ericsson Connected Vehicle Cloud (CVC) platform to further enable its digital vehicle services in more than 120 markets worldwide for the next five years.

18

¹⁷ *Id.*

¹⁸ <https://www.ericsson.com/en/press-releases/2018/11/ericsson-and-volvo-cars-sign-five-year-connected-vehicle-cloud-worldwide-deal>.

The deal – which will enable Volvo Cars to provide car owners and drivers with its latest developments in connected car digital services such as automation, fleet management, telematics, navigation, and infotainment – is the largest to date for Ericsson Connected Vehicle Cloud.

19

Engine Control Module (ECM). CONTROL UNIT, EXCH

Part Number: 36003329

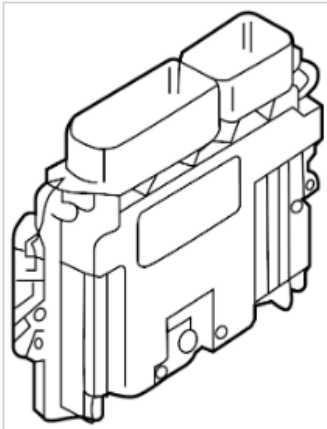

ECC. Engine Control Computer. Engine Control Unit (ECU). General Purpose Embedded Control Unit. Powertrain Control Module. Control System, Fuel Supply. Control Unit, (Exchange). A module in a vehicle used to monitor and control many components of the vehicle's engine management system.

CONTROL UNIT, EXCH

Fits XC40 (2018 - 2024)

CH -109045. CH -151858. CH -183002. CH -277658. CH -870511. CH 1-. CH 899000-999999. EXCH FOR 31459638. FC 19; CH -754570, FC 22; CH -785783, FC 25; CH -785783. FC 21; CH -495320, FC 22; CH -495552, FC 25; CH -495552. FC 21; CH -84372, FC 25; CH -84372, FC 36; CH -63578. FC 21; CH -94577, FC 22; CH -94495. FC 21; CH 899000-999999, FC 25; CH 899000-999999, FC 36; CH 899000-999999. FC 25; CH -224836, FC 35; CH -190273, FC 70; CH -224836.



11 people have looked at this part recently

20

¹⁹ *Id.*

²⁰ https://usparts.volvocars.com/p/Volvo__XC40/Engine-Control-Module-ECM-CONTROL-UNIT--EXCH/97592607/36003329.html.

Bracket. ATM. CHINA. TCAM Telematic and VGM VEHILCE Gateway. Vehicle Connectivity Module (VCM).
 Part Number: 32210507

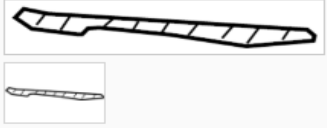

BRACKET
 Fits C40, XC40

FC 19; CH 490310-, FC 22; CH 489304-, FC 25; CH 489304-. Variant code: CB04 and XAOE. Variant code: XAOE.

DIAGRAMS AND KITS	<p>Vehicle Connectivity Module </p> <p>#12</p> <p>Vehicle Connectivity Module. FC 19; CH 490310-, FC 22; CH 489304-, FC 25; CH 489304-. CHINA. ATM. Variant code: CB04 and XAOE.</p>
WHAT THIS FITS	
ATTACHMENTS	
PRODUCT TYPES	

21

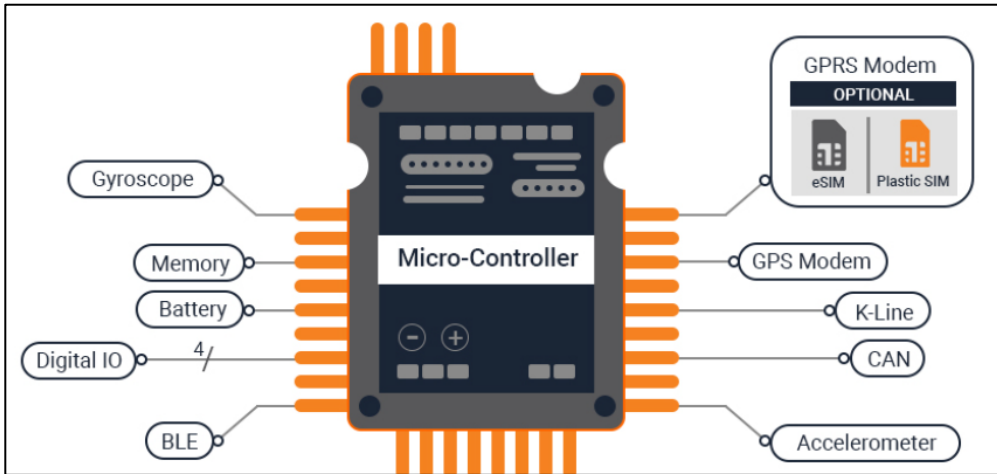

22

²¹ *Id.*

²² <https://www.embitel.com/blog/embedded-blog/tech-behind-telematics-explained-how-does-a-vehicle-telematics-solution-work>.

- A **CAN Bus** module that manages all the communication with the vehicle ECUs. Many of the commercially available telematics devices also support OBD II, MOST, LIN interfaces. The TCU communicates with the vehicle ECUs through CAN bus and fetches crucial information such as engine performance, vehicle speed, data from the Tire Pressure measuring Sensors, etc. A telematics system may also use K/Line bus to alert the user about theft (by notifying the user if the vehicle is switched on by anyone), or to enable remote locking and unlocking of the vehicle.

23

39. The Volvo XC40 comprises a plurality of monitoring units configured to communicate with at least one interface unit using a first protocol, wherein the at least one interface unit is communicably connected to a distributed control system, and the at least one interface unit is further configured to receive data values from the distributed control system using a second protocol; wherein the plurality of monitoring units comprises at least one complex monitoring unit (e.g., the Volvo cloud server platform) and at least one basic monitoring unit (e.g., the Volvo Cars App with remote services):

Volvo Cars app

Updated 2023-03-22

With the Volvo Cars app, you can maintain contact with your vehicle through a number of app functions.^[1]

You can, for example, lock or unlock the vehicle and start the climate system in the vehicle before departure.^[2]

24

²³ *Id.*

²⁴ <https://www.volvocars.com/en-ca/support/car/xc40-mild-hybrid/article/100584eb8cf71df6c0a801511d02c630>.

Remote Start of the vehicle using the Volvo Cars app

Updated 2023-03-22

With the Volvo Cars app, the vehicle's engine can be started remotely to warm up or cool down the vehicle to a comfortable temperature.^[1]

First, make sure it is permissible under local environmental regulations and laws to start the vehicle in its present location.

The vehicle can be started from the climate function in the  tab. Enter when you plan to start driving (in number of minutes, 1-15, from the current time). Confirm that you want to start the vehicle and verify your identify using your phone's unlock method (PIN code, password, pattern, TouchID, FaceID, etc.).

It may also be possible to select 30 minutes^[2]. In that case, only the climate system starts and not the engine. Read more about Remote Start of the climate system in the separate section.

It is possible to activate the function in the Volvo Cars app twice in succession. After that, the vehicle has to be started with the key before you can activate the function via the app again.

When the vehicle is remote-started, functions such as heating for the seats, door mirror and rear window will also be activated.

25

²⁵ <https://www.volvocars.com/en-ca/support/car/xc40-mild-hybrid/article/420b402a0886c141c0a801511699ad33>.

Remote Start of the climate system using the Volvo Cars app

Updated 2023-03-22

If the vehicle is equipped with the climate package*, you can start the climate system immediately or enter a time at which you will use the vehicle.^[1] If you choose to enter a time, the climate system will start automatically to heat up the passenger compartment before departure.

Direct-starting the climate system

Start the climate system from the climate function in the  tab. Enter when you plan to start driving (in number of minutes from the current time). When 30 minutes is selected, only the climate system will start to warm up the passenger compartment. If 1-15 minutes is selected, there is also the option to remote-start the engine to help the vehicle more quickly reach a comfortable temperature. Read more about Remote Start of the vehicle in the separate section.

Setting climate system timers

A timer can be set to automatically start the climate system to warm up the passenger compartment before departure. You can choose a time, date, day of the week and whether the setting should be repeated every week. Up to 8 different timers can be set.

Timers are set from the climate function in the  tab.

26

40. The Volvo XC40 comprises a plurality of monitoring units configured to communicate with at least one interface unit using a first protocol, wherein the at least one interface unit is communicably connected to a distributed control system, and the at least one interface unit is further configured to receive data values from the distributed control system using a second protocol; wherein the at least one complex monitoring unit (e.g., the Volvo cloud server platform) is configured to receive a plurality of data values (e.g., engine performance, vehicle speed, and other data) from the at least one interface unit (e.g., the TCU) using the first protocol (e.g., cellular and/or Bluetooth) and to generate programmatic instructions for the at least one basic monitoring unit (e.g., the Volvo Cars App):

Ericsson (NASDAQ: ERIC) has been selected by Volvo Car Group (Volvo Cars) to provide the industrialized Ericsson Connected Vehicle Cloud (CVC) platform to further enable its digital vehicle services in more than 120 markets worldwide for the next five years.

27

The deal – which will enable Volvo Cars to provide car owners and drivers with its latest developments in connected car digital services such as automation, fleet management, telematics, navigation, and infotainment – is the largest to date for Ericsson Connected Vehicle Cloud.

28

Volvo Cars app

Updated 2023-03-22

With the Volvo Cars app, you can maintain contact with your vehicle through a number of app functions.^[1]

You can, for example, lock or unlock the vehicle and start the climate system in the vehicle before departure.^[2]

29

²⁷ <https://www.ericsson.com/en/press-releases/2018/11/ericsson-and-volvo-cars-sign-five-year-connected-vehicle-cloud-worldwide-deal>.

²⁸ *Id.*

²⁹ <https://www.volvocars.com/en-ca/support/car/xc40-mild-hybrid/article/100584eb8cf71df6c0a801511d02c630>.

Remote Start of the vehicle using the Volvo Cars app

Updated 2023-03-22

With the Volvo Cars app, the vehicle's engine can be started remotely to warm up or cool down the vehicle to a comfortable temperature.^[1]

First, make sure it is permissible under local environmental regulations and laws to start the vehicle in its present location.

The vehicle can be started from the climate function in the  tab. Enter when you plan to start driving (in number of minutes, 1-15, from the current time). Confirm that you want to start the vehicle and verify your identity using your phone's unlock method (PIN code, password, pattern, TouchID, FaceID, etc.).

It may also be possible to select 30 minutes^[2]. In that case, only the climate system starts and not the engine. Read more about Remote Start of the climate system in the separate section.

It is possible to activate the function in the Volvo Cars app twice in succession. After that, the vehicle has to be started with the key before you can activate the function via the app again.

When the vehicle is remote-started, functions such as heating for the seats, door mirror and rear window will also be activated.

30

41. The Volvo XC40 comprises a plurality of monitoring units configured to communicate with at least one interface unit using a first protocol, wherein the at least one interface unit is communicably connected to a distributed control system, and the at least one interface unit is further configured to receive data values from the distributed control system using a second protocol; wherein the at least one basic monitoring unit (e.g., the Volvo Cars app) is configured to receive the programmatic instructions (e.g., vehicle status data) and in response thereto to receive a subset of the plurality of data values from the at least one interface unit (e.g., TCU) using the first protocol (e.g., cellular):

³⁰ <https://www.volvocars.com/en-ca/support/car/xc40-mild-hybrid/article/420b402a0886c141c0a801511699ad33>.

Volvo Cars app

Updated 2023-03-22

With the Volvo Cars app, you can maintain contact with your vehicle through a number of app functions.^[1]

You can, for example, lock or unlock the vehicle and start the climate system in the vehicle before departure.^[2]

31

Remote Start of the climate system using the Volvo Cars app

Updated 2023-03-22

If the vehicle is equipped with the climate package*, you can start the climate system immediately or enter a time at which you will use the vehicle.^[1] If you choose to enter a time, the climate system will start automatically to heat up the passenger compartment before departure.

Direct-starting the climate system

Start the climate system from the climate function in the  tab. Enter when you plan to start driving (in number of minutes from the current time). When 30 minutes is selected, only the climate system will start to warm up the passenger compartment. If 1-15 minutes is selected, there is also the option to remote-start the engine to help the vehicle more quickly reach a comfortable temperature. Read more about Remote Start of the vehicle in the separate section.

Setting climate system timers

A timer can be set to automatically start the climate system to warm up the passenger compartment before departure. You can choose a time, date, day of the week and whether the setting should be repeated every week. Up to 8 different timers can be set.

Timers are set from the climate function in the  tab.

32

Tire Pressure Monitoring System (TPMS)

TPMS uses sensors mounted in the tire valves to check inflation pressure levels. When the vehicle is moving at a speed of approximately 20 mph (30 km/h) or faster, these sensors transmit inflation pressure data to a receiver located in the vehicle.

33

³¹ <https://www.volvocars.com/en-ca/support/car/xc40-mild-hybrid/article/100584eb8cf71df6c0a801511d02c630>.

³² <https://www.volvocars.com/en-ca/support/car/xc40-mild-hybrid/article/420b402a0886c141c0a801511699ad33>.

³³ https://volvo.custhelp.com/app/answers/detail/a_id/9362/~/tire-pressure-monitoring-system-%28tpms%29.

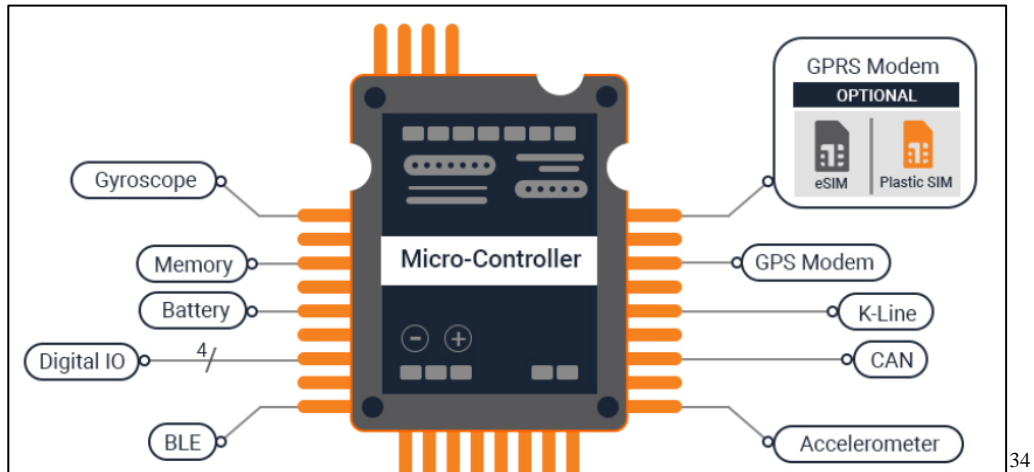

34

- A **CAN Bus** module that manages all the communication with the vehicle ECUs. Many of the commercially available telematics devices also support OBD II, MOST, LIN interfaces. The TCU communicates with the vehicle ECUs through CAN bus and fetches crucial information such as engine performance, vehicle speed, data from the Tire Pressure measuring Sensors, etc. A telematics system may also use K/Line bus to alert the user about theft (by notifying the user if the vehicle is switched on by anyone), or to enable remote locking and unlocking of the vehicle.

35

42. Defendants have and continue to indirectly infringe one or more claims of the '002 Patent by knowingly and intentionally inducing others, including Volvo customers and end-users, to directly infringe, either literally or under the doctrine of equivalents, by making, using, offering to sell, selling, and/or importing into the United States products that include infringing technology.

43. Defendants, with knowledge that these products, or the use thereof, infringe the '002 Patent at least as of the date of this Complaint, knowingly and intentionally induced, and continue to knowingly and intentionally induce, direct infringement of the '002 Patent by providing these products to customers and end-users for use in an infringing manner.

³⁴ <https://www.embitel.com/blog/embedded-blog/tech-behind-telematics-explained-how-does-a-vehicle-telematics-solution-work>.

³⁵ *Id.*

Alternatively, on information and belief, Defendants have adopted a policy of not reviewing the patents of others, including specifically those related to Defendants' specific industry, thereby remaining willfully blind to the Patents-in-Suit at least as early as the issuance of the Patents-in-Suit.

44. Defendants have and continue to induce infringement by others, including customers and end-users, with the intent to cause infringing acts by others or, in the alternative, with the belief that there was a high probability that others, including end-users, infringe the '002 Patent, but while remaining willfully blind to the infringement. Defendants have and continue to induce infringement by their customers and end-users by supplying them with instructions on how to operate the infringing technology in an infringing manner, while also making publicly available information on the infringing technology via Defendants' websites, product literature and packaging, and other publications.³⁶

45. LAG has suffered damages as a result of Defendants' direct and indirect infringement of the '002 Patent in an amount to be proved at trial.

46. LAG has suffered, and will continue to suffer, irreparable harm as a result of Defendants' infringement of the '002 Patent, for which there is no adequate remedy at law, unless Defendants' infringement is enjoined by this Court.

COUNT III
(Infringement of the '238 Patent)

47. Paragraphs 1 through 18 are incorporated by reference as if fully set forth herein.

48. LAG has not licensed or otherwise authorized Defendants to make, use, offer for sale, sell, or import any products that embody the inventions of the '238 Patent.

³⁶ See Volvo XC40 Owner's Manual and other materials, available at: <https://volvo.custhelp.com/app/manuals/ownersmanualinfo>.

49. Defendants have and continue to infringe the '238 Patent, either literally or under the doctrine of equivalents, without authority and in violation of 35 U.S.C. § 271, by one or more of making, using, offering to sell, selling, and/or importing into the United States products that satisfy each and every limitation of one or more claims of the '238 Patent. Such products include, but are not limited to, Volvo vehicles with direct injection engines, in all trims and configurations, including the Accused Vehicles, such as the D13TC Engine Family, direct injection diesel engine, in the Volvo VAH 600.

50. For example, Defendants have and continue to directly infringe at least Claim 1 of the '238 Patent by making, using, offering to sell, selling, and/or importing into the United States products that include Volvo vehicles with direct injection engines, in all trims and configurations, including the Accused Vehicles, such as the D13TC Engine Family, direct injection diesel engine, in the Volvo VAH 600.

51. The Volvo VAH 600 comprises a directly injecting internal combustion engine (e.g., Volvo's D13TC Engine Family, direct injection diesel engine), comprising at least one cylinder which has a combustion space (e.g., combustion chambers in the six cylinder engine):



37

Engine Specifications

Type
Direct Injection Diesel

Compression Ratio
18:1

Number of Cylinders
6, In-Line

Firing order
1-5-3-6-2-4

Bore & Stroke
5.16" x 6.22" [131mm x 158mm]

Engine Break Retarding Power
500 HP [372 kW] @ 2200 RPM

Displacement
780 [13L]

Dry Weight (Approx)
2635lbs [1195kg]

38

52. The Volvo VAH 600 comprises a directly injecting internal combustion engine, comprising at least one cylinder which has a combustion space in which a piston executes an oscillating movement (e.g., piston movement is oscillatory, increasing pressure and temperature in preparation for combustion, aided by injectors to maximize the benefits of higher fuel pressure), and an injection nozzle for injection of fuel into the combustion space:

³⁷ <https://www.volvotrucks.us/trucks/powertrain/d13tc/>.

³⁸ *Id.*

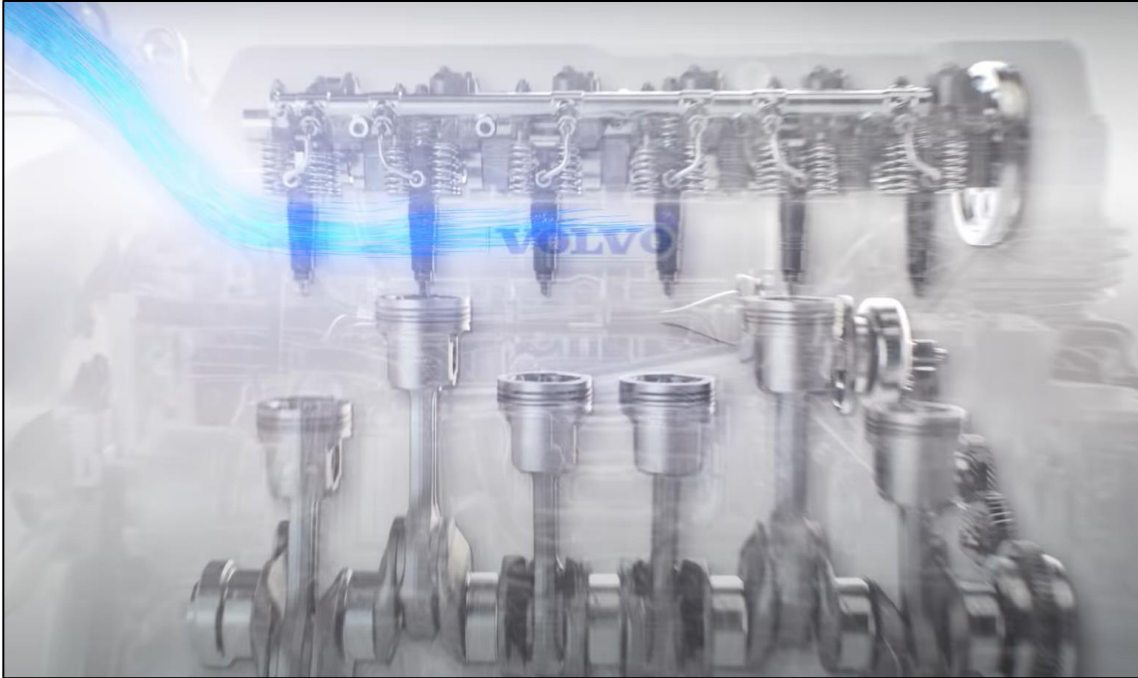

39



40

³⁹ <https://www.youtube.com/watch?v=j7eeU7KbnG0>.

⁴⁰ *Id.*

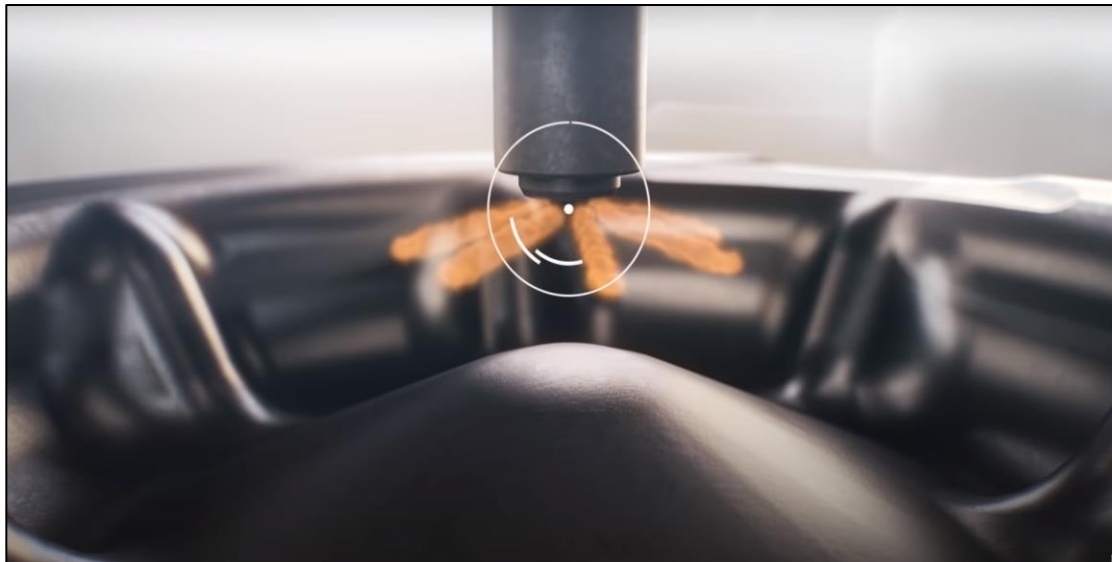

41

53. The Volvo VAH 600 comprises a directly injecting internal combustion engine, comprising at least one cylinder which has a combustion space in which a piston executes an oscillating movement, and an injection nozzle for injection of fuel into the combustion space wherein the piston has a piston recess, which, in a central region thereof, has an elevation extending in a cylinder head direction (e.g., the top of the cylinder with a recess shape), and a surface of the piston recess adjoining the elevation in a recess edge direction is connected to the elevation via a radius:

⁴¹ *Id.*

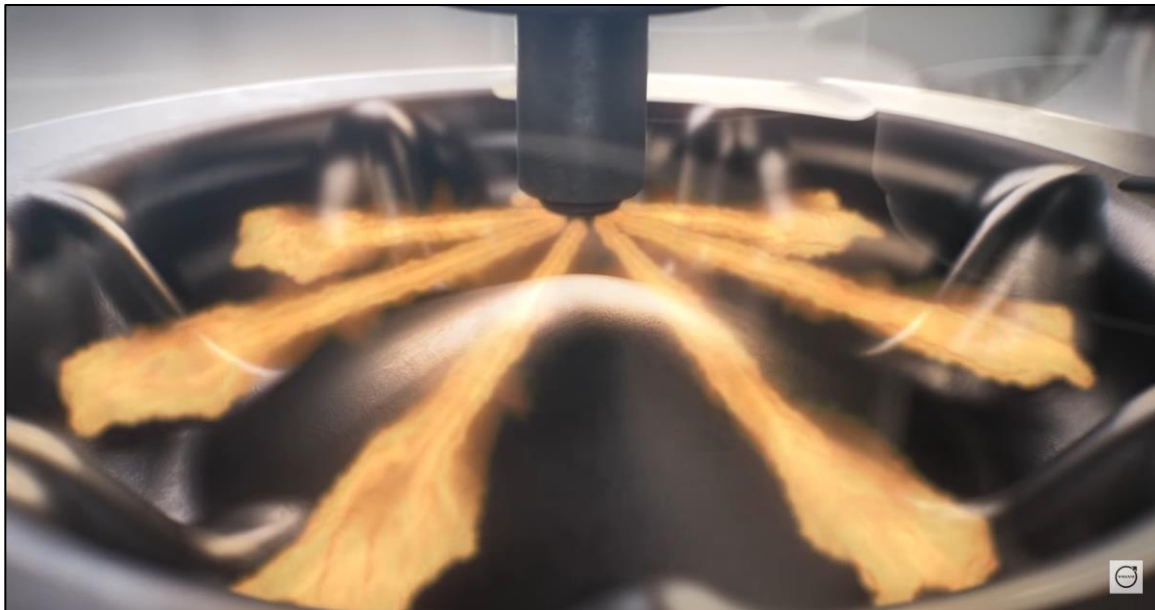

42

54. The Volvo VAH 600 comprises a directly injecting internal combustion engine, comprising at least one cylinder which has a combustion space in which a piston executes an oscillating movement, and an injection nozzle for injection of fuel into the combustion space wherein the piston has a piston recess, which, in a central region thereof, has an elevation extending in a cylinder head direction, and a surface of the piston recess adjoining the elevation in a recess edge direction is connected to the elevation via a radius so that an injection jet impinging the surface and injected as early as possible is distributed both in an elevation direction and in the recess edge direction, and the surface is substantially planar and has an ascending gradient in the recess edge direction such that an injection jet injected as late as possible impinges onto the surface, the last-mentioned injection jet being distributed both in the elevation direction and in the recess edge direction:

⁴² <https://www.youtube.com/watch?v=j7eeU7KbnG0>.

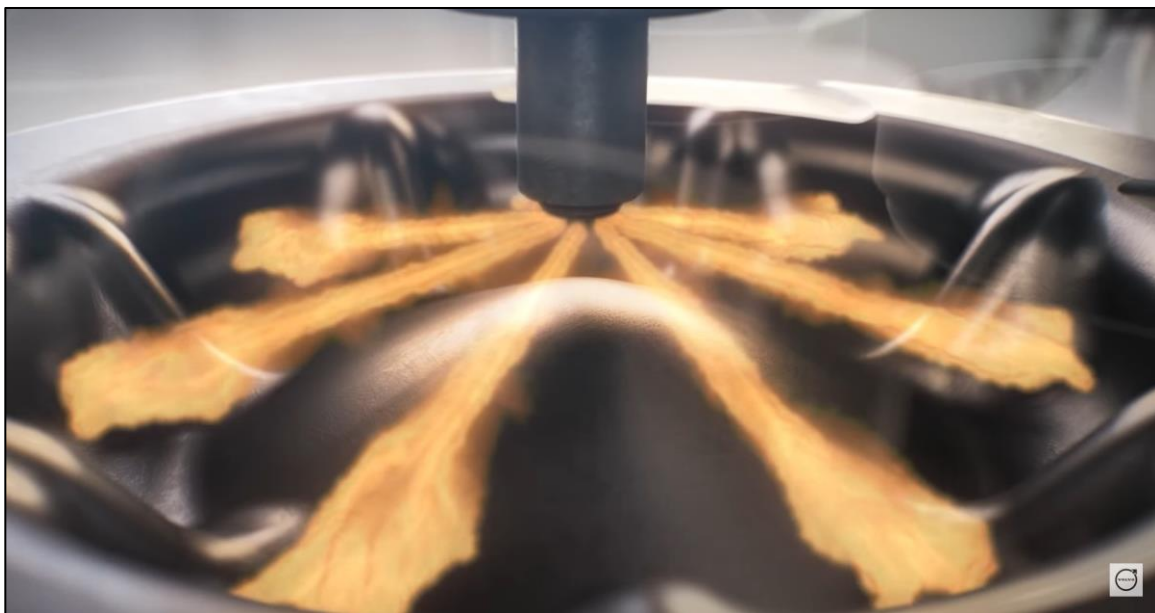

43

55. Defendants have and continue to indirectly infringe one or more claims of the '238 Patent by knowingly and intentionally inducing others, including Volvo customers and end-users, to directly infringe, either literally or under the doctrine of equivalents, by making, using, offering to sell, selling, and/or importing into the United States products that include infringing technology.

56. Defendants, with knowledge that these products, or the use thereof, infringe the '238 Patent at least as of the date of this Complaint, knowingly and intentionally induced, and continue to knowingly and intentionally induce, direct infringement of the '238 Patent by providing these products to customers and end-users for use in an infringing manner. Alternatively, on information and belief, Defendants have adopted a policy of not reviewing the patents of others, including specifically those related to Defendants' specific industry, thereby remaining willfully blind to the Patents-in-Suit at least as early as the issuance of the Patents-in-Suit.

57. Defendants have and continue to induce infringement by others, including

⁴³ <https://www.youtube.com/watch?v=j7eeU7KbnG0>.

customers and end-users, with the intent to cause infringing acts by others or, in the alternative, with the belief that there was a high probability that others, including end-users, infringe the '238 Patent, but while remaining willfully blind to the infringement. Defendants have and continue to induce infringement by their customers and end-users by supplying them with instructions on how to operate the infringing technology in an infringing manner, while also making publicly available information on the infringing technology via Defendants' websites, product literature and packaging, and other publications.⁴⁴

58. LAG has suffered damages as a result of Defendants' direct and indirect infringement of the '238 Patent in an amount to be proved at trial.

59. LAG has suffered, and will continue to suffer, irreparable harm as a result of Defendants' infringement of the '238 Patent, for which there is no adequate remedy at law, unless Defendants' infringement is enjoined by this Court.

COUNT IV
(Infringement of the '353 Patent)

60. Paragraphs 1 through 18 are incorporated by reference as if fully set forth herein.

61. LAG has not licensed or otherwise authorized Defendants to make, use, offer for sale, sell, or import any products that embody the inventions of the '353 Patent.

62. Defendants have and continue to infringe the '353 Patent, either literally or under the doctrine of equivalents, without authority and in violation of 35 U.S.C. § 271, by one or more of making, using, offering to sell, selling, and/or importing into the United States products that satisfy each and every limitation of one or more claims of the '353 Patent. Such products include, but are not limited to, Volvo's IntelliSafe Assist system, included in vehicles, in all trims and

⁴⁴ See Product Literature for the Volvo VAH 600, available at: <https://www.volvotrucks.us/trucks/vah/>.

configurations, including the Accused Vehicles, such as the Volvo XC90

63. For example, Defendants have and continue to directly infringe at least Claim 1 of the '353 Patent by making, using, offering to sell, selling, and/or importing into the United States products that include IntelliSafe Assist system, such as the Volvo XC90.

64. The Volvo XC90 performs a method of forming an image of a mobile object:

"IntelliSafe Assist" makes it easier and safer to drive where you want the road to take you. "IntelliSafe Assist" consists of "Adaptive Cruise Control" (ACC), "Pilot Assist", "Distance Alert" and "Lane Keeping Aid".

45

A bird's eye view of the car

The all-new XC90 also features a 360° Surround View that gives the driver a bird's eye view of the area surrounding the car

This bird's eye view is enabled by four concealed fish-eye cameras – one integrated into the front, one integrated in each of the door mirrors and one fitted above the rear license plate.

The 360° Surround View also gives the driver comfortable access to other views of the surrounding area such as front, rear and side views.

"The 360° Surround View is exceptionally useful in situations where the driver's direct view is obstructed, such as leaving a tight driveway with obstacles on the sides or when reversing towards a trailer or caravan," says Dr. Peter Mertens. "360° Surround View also provides great support during parking, for instance when you want to make sure that all parts of the car are within the lines of a parking spot."

46

IntelliSafe Assist is the new name grouping for the following features, which make use of the camera and radar integrated behind the windshield:

47

Park Assist Pilot is an evolution of the system currently offered on the S60 and V60. It adds four front and two side sensors to Park Assist and can take over the steering completely when parking (the driver stays in control of the accelerator, brakes and transmission shifting). The system makes parking extremely easy and can steer the car into parallel and perpendicular parking spaces.

48

⁴⁵ [https://accessories.volvocars.com/en-us/XC90\(16-\)/Accessories/Document/VCC-515670/2016](https://accessories.volvocars.com/en-us/XC90(16-)/Accessories/Document/VCC-515670/2016).

⁴⁶ <https://www.media.volvocars.com/us/en-us/media/pressreleases/148124/all-new-xc90-innovative-intellisafe-solutions-make-tricky-parking-and-tight-maneuvers-safer-and-easi>.

⁴⁷ <https://www.media.volvocars.com/us/en-us/media/pressreleases/163169/model-overview-2016-volvo-xc90>.

⁴⁸ *Id.*

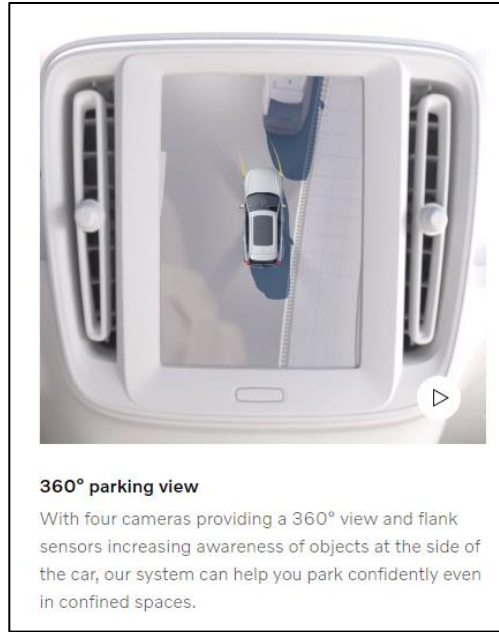

⁴⁹ <https://www.volvocars.com/us/cars/xc90/features/>.

⁵⁰ <https://www.media.volvocars.com/global/en-us/media/photos/136808/intellisafe-in-spa-monitoring-360-around-the-car>.

In cars developed on the new Scalable Product Architecture (SPA), camera and radar technologies are extended to detect more objects around the car and to offer support at higher speeds and in more situation. The sensors used by the collision-avoiding solutions are also part of the extended range of features that makes the drive more enjoyable by simplifying complex traffic situations.

51

65. The Volvo XC90 performs a method of obtaining a plurality of first images (e.g., images the 360-degree image cameras) of the mobile object using a first imaging technique (e.g., 360-degree image camera processing) while obtaining a plurality of first measurements corresponding to movements of the mobile object using a first sensor system, the first sensor system (e.g., ultrasonic sensors) being independent from the first imaging technique:



52

⁵¹ *Id.*

⁵² <https://www.volvocarscincinnati.com/volvo-driver-assistance-system.htm>.



53

Sensor technologies

Volvo Cars is developing a holistic solution that generates exact positioning and a complete 360° view of the car's surroundings. This is achieved by a combination of multiple radars, cameras and laser sensors. A redundant network of computers processes the information, generating a real-time map of moving and stationary objects in the environment.

Precise positioning is based on this surround information together with GPS and a high definition 3D digital map that is continuously updated with real-time data. The system is reliable enough to work without requiring driver supervision.

54

High definition 3D digital map

A high definition 3D digital map is the tool used to provide the vehicle with information about the surroundings, e.g. altitude, road curvature, number of lanes, geometry of tunnels, guard rails, signs, exits, etc. The position geometry is in many cases at centimetre level.

55

⁵³ <https://www.volvocars.com/us/cars/xc90/features/>.

⁵⁴ <https://www.media.volvocars.com/global/en-us/media/pressreleases/158276/volvo-cars-presents-a-unique-solution-for-integrating-self-driving-cars-into-real-traffic>.

⁵⁵ *Id.*

A personal parking valet

Our Park Assist Pilot can park your car for you. With a press of the button it scans the parking slot using ultrasonic sensors. You control the speed and direction while the car steers for you.

56

Front park assist is included with the optional Park Assist Pilot. Four ultrasonic sensors integrated into the lower front grilles measure the distance to obstacles just over 2.5 feet (0.8 m) during speeds under 6 mph (10 km/h). The distance to each sensor is displayed graphically on the center display. A warning tone alerts the driver as the XC90 gets closer to an object. At 11.8 inches (0.3 m) the sound becomes constant.

57

Ultrasonic sensors

Twelve ultrasonic sensors around the car are used to identify objects close to the vehicle and support autonomous drive at low speeds.

The sensors are based on the technology used for current park assist functions enhanced with advanced signal processing.

A typical example of when this technology is useful is for detecting unexpected situations, such as pedestrians or hazards on the road close to the car.

58

⁵⁶ <https://www.volvocarsnorthmiami.com/intellisafe.htm>.

⁵⁷ <https://www.media.volvocars.com/us/en-us/media/pressreleases/163169/model-overview-2016-volvo-xc90>.

⁵⁸ <https://www.media.volvocars.com/global/en-us/media/pressreleases/158276/volvo-cars-presents-a-unique-solution-for-integrating-self-driving-cars-into-real-traffic>.

Ultrasonic sensors detect the parking space

The parking manoeuvre is based on information from twelve ultrasonic sensors around the car. When the driver activates the Park Assist Pilot in a parallel parking situation, the sensors start to scan the side of the car for empty parking slots. When a parking slot measuring a minimum of 1.2 times the car's length is detected, the driver is notified by an audible signal and a message in the instrument cluster. In a bay parking situation, the slot needs to be the width of the car plus one metre.

The display then guides the driver step by step via texts and animations in the instrument cluster until the car is parked.

59

66. The Volvo XC90 performs a method of associating the plurality of first images (e.g., images from the 360-degree cameras) with first movement states of the mobile object using the first measurements (e.g., data from ultrasonic sensors):

Ultrasonic sensors detect the parking space

The parking manoeuvre is based on information from twelve ultrasonic sensors around the car. When the driver activates the Park Assist Pilot in a parallel parking situation, the sensors start to scan the side of the car for empty parking slots. When a parking slot measuring a minimum of 1.2 times the car's length is detected, the driver is notified by an audible signal and a message in the instrument cluster. In a bay parking situation, the slot needs to be the width of the car plus one metre.

The display then guides the driver step by step via texts and animations in the instrument cluster until the car is parked.

60

⁵⁹ <https://www.media.volvocars.com/global/en-us/media/pressreleases/148124/all-new-xc90-innovative-intellisafe-solutions-make-tricky-parking-and-tight-manoeuvres-easy-and-safe>.

⁶⁰ <https://www.media.volvocars.com/global/en-us/media/pressreleases/148124/all-new-xc90-innovative-intellisafe-solutions-make-tricky-parking-and-tight-manoeuvres-easy-and-safe>.

IntelliSafe parking. The IntelliSafe support technologies include an extended Park Assist Pilot, which now also offers automatic reversing into a parking bay as well as entering and exiting a parallel parking spot. The XC90 can also display a digitally created bird's-eye view of the 360° area around the car on the large center screen.

The further-developed Park Assist Pilot facilitates both parallel and bay parking by taking over and operating the steering wheel while the driver handles the gearbox and controls the car's speed.



The park assist function expresses audible and visible output to help the driver to determine the distance to stationary and moving objects during parking. The system uses four front and four rear ultrasonic sensors positioned symmetrically left to right on the front and rear bumper. Additional four sensors are positioned at the front and rear wheel housing to scan the side of the vehicle. Click to enlarge.



A 360° Surround view gives the driver a bird's-eye view, an overview of the surrounding area, seen from a point above the car. The bird's-eye view is enabled by four concealed fish-eye cameras—one integrated into the front, one integrated in each of the door mirrors and one fitted above the rear number plate. The image illustrates the bird view in the touch screen. Click to enlarge.

The parking maneuver is based on information from twelve ultrasonic sensors around the car. When the driver activates the Park Assist Pilot in a parallel parking situation, the sensors start to scan the side of the car for empty parking slots. When a parking slot measuring a minimum of 1.2 times the car's length is detected, the driver is notified by an audible signal and a message in the instrument cluster. In a bay parking situation, the slot needs to be the width of the car plus one meter.

61

67. The Volvo XC90 performs a method of obtaining a plurality of second images of the mobile object using a second imaging technique (e.g., images from the front camera image processing) while obtaining a plurality of second measurements corresponding to movements of the mobile object using a second sensor system (e.g. radar sensors), the second sensor system being independent from the second imaging technique:

⁶¹ <https://www.greencarcongress.com/2014/07/20140722-xc90.html>.



The front-facing camera and radar in the all-new XC90 is located in the upper part of the windshield, integrated behind the rear-view mirror. This feature is used in various active safety systems e.g. City Safety, Driver Alert Control, Road Sign Information and ACC with Queue Assist.

62

Sensor technologies

Volvo Cars is developing a holistic solution that generates exact positioning and a complete 360° view of the car's surroundings. This is achieved by a combination of multiple radars, cameras and laser sensors. A redundant network of computers processes the information, generating a real-time map of moving and stationary objects in the environment.

Precise positioning is based on this surround information together with GPS and a high definition 3D digital map that is continuously updated with real-time data. The system is reliable enough to work without requiring driver supervision.

63

Combined radar and camera

The combined 76 GHz frequency-modulated continuous wave radar and camera placed in the windshield is the same as that in the all-new XC90. This system reads traffic signs and the road's curvature and can detect objects on the road such as other road users.

64

Trifocal camera

In addition, a trifocal camera placed behind the upper part of the windshield is three cameras in one, providing a broad 140° view, a 45° view and a long-range, yet narrow, 34° view for improved depth perception and distant-object detection. The camera can spot suddenly appearing pedestrians and other unexpected road hazards.

65

⁶² <https://www.media.volvocars.com/us/en-us/media/photos/148213/camera-and-radar>.

⁶³ <https://www.media.volvocars.com/global/en-us/media/pressreleases/158276/volvo-cars-presents-a-unique-solution-for-integrating-self-driving-cars-into-real-traffic>.

⁶⁴ *Id.*

⁶⁵ *Id.*

"IntelliSafe Assist" makes it easier and safer to drive where you want the road to take you. "IntelliSafe Assist" consists of "Adaptive Cruise Control" (ACC), "Pilot Assist", "Distance Alert" and "Lane Keeping Aid".

66

Pilot Assist function – Adaptive Cruise Control is supplemented by new Pilot Assist. This means the XC90 can keep the set speed and distance to a vehicle in front, and also support the driver in keeping the car within the lane. It relieves the driver from the need to constantly adapt the speed to the vehicle in front and adjust the steering to keep within the lane in low speed traffic.

- Occurs at "queue speeds" below 30 mph (50 km/h).
- This is achieved by means of the camera and radar in the windshield, which monitor the car's position in relation to visible lane markings and a vehicle in front, as well as light steering adjustments, if the car is coming close to passing a lane marking without the indicator being used.
- Will keep the car's position in its lane by using light steering torque, in relation to visible lane markings and a vehicle in front of it. Driver must have his hands on the steering wheel.
- If Pilot Assist is not activated under 30 mph (50 km/h), Adaptive Cruise Control will still keep the speed and distance to the vehicle in front, but there will be no steering corrections.

67

68. The Volvo XC90 performs a method of associating the plurality of second images (e.g., images from the front camera) with second movement states of the mobile object using the first measurements (e.g., the radar data with the ultrasonic sensor data).

69. The Volvo XC90 performs a method of forming an image of the mobile object based on said plurality of first images (e.g., images from the 360-degree cameras), said associated plurality of first movement measurements, and said first movement states (e.g., from the ultrasonic sensors) and on said plurality of second images (e.g., from the front camera), said associated plurality of second movement measurements, and said second movement states (e.g., from the radar sensors), wherein the first imaging technique (e.g., the 360-degree cameras) is different from

⁶⁶ [https://accessories.volvocars.com/en-us/XC90\(16-\)/Accessories/Document/VCC-515670/2016](https://accessories.volvocars.com/en-us/XC90(16-)/Accessories/Document/VCC-515670/2016).

⁶⁷ <https://www.media.volvocars.com/us/en-us/media/pressreleases/163169/model-overview-2016-volvo-xc90>.

the second imaging technique (e.g., the front camera):

On the new XC90, an additional level of parking support is available with the 360-degree camera. With this new option, the driver can see a bird's eye view of the car's surroundings (up to 6 mph or 10 km/h) via a virtual picture of the car on the center screen display. The birds-eye view is generated by four hidden cameras located in the lower part of the front Volvo badge, both side mirrors and the tailgate.

68



The front-facing camera and radar in the all-new XC90 is located in the upper part of the windscreen, integrated behind the rear-view mirror. This feature is used in various active safety systems e.g. City Safety, Driver Alert Control, Road Sign Information and ACC with Queue Assist.

69

Trifocal camera

In addition, a trifocal camera placed behind the upper part of the windscreen is three cameras in one, providing a broad 140° view, a 45° view and a long-range, yet narrow, 34° view for improved depth perception and distant-object detection. The camera can spot suddenly appearing pedestrians and other unexpected road hazards.

70

70. Defendants have and continue to indirectly infringe one or more claims of the '353 Patent by knowingly and intentionally inducing others, including Volvo customers and end-users, to directly infringe, either literally or under the doctrine of equivalents, by making, using, offering to sell, selling, and/or importing into the United States products that include infringing technology.

71. Defendants, with knowledge that these products, or the use thereof, infringe the

⁶⁸ <https://www.media.volvocars.com/us/en-us/media/pressreleases/163169/model-overview-2016-volvo-xc90>.

⁶⁹ <https://www.media.volvocars.com/us/en-us/media/photos/148213/camera-and-radar>.

⁷⁰ *Id.*

'353 Patent at least as of the date of this Complaint, knowingly and intentionally induced, and continue to knowingly and intentionally induce, direct infringement of the '353 Patent by providing these products to customers and end-users for use in an infringing manner. Alternatively, on information and belief, Defendants have adopted a policy of not reviewing the patents of others, including specifically those related to Defendants' specific industry, thereby remaining willfully blind to the Patents-in-Suit at least as early as the issuance of the Patents-in-Suit.

72. Defendants have and continue to induce infringement by others, including customers and end-users, with the intent to cause infringing acts by others or, in the alternative, with the belief that there was a high probability that others, including end-users, infringe the '353 Patent, but while remaining willfully blind to the infringement. Defendants have and continue to induce infringement by their customers and end-users by supplying them with instructions on how to operate the infringing technology in an infringing manner, while also making publicly available information on the infringing technology via Defendants' websites, product literature and packaging, and other publications.⁷¹

73. LAG has suffered damages as a result of Defendants' direct and indirect infringement of the '353 Patent in an amount to be proved at trial.

74. LAG has suffered, and will continue to suffer, irreparable harm as a result of Defendants' infringement of the '353 Patent, for which there is no adequate remedy at law, unless Defendants' infringement is enjoined by this Court.

DEMAND FOR JURY TRIAL

⁷¹ See Volvo XC90 Owner's Manual and other materials, available at: <https://volvo.custhelp.com/app/manuals/ownersmanualinfo>.

Plaintiff hereby demands a jury for all issues so triable.

PRAYER FOR RELIEF

WHEREFORE, LAG prays for relief against Defendants as follows:

- a. Entry of judgment declaring that Defendants have directly and/or indirectly infringed one or more claims of the Patents-in-Suit;
- b. An order pursuant to 35 U.S.C. § 283 permanently enjoining Defendants, their officers, agents, servants, employees, attorneys, and those persons in active concert or participation with them, from further acts of infringement of the Patents-in-Suit;
- c. An order awarding damages sufficient to compensate LAG for Defendants' infringement of the Patents-in-Suit, but in no event less than a reasonable royalty, together with interest and costs;
- d. Entry of judgment declaring that this case is exceptional and awarding LAG its costs and reasonable attorney fees under 35 U.S.C. § 285; and
- e. Such other and further relief as the Court deems just and proper.

Dated: July 30, 2024

Respectfully submitted,

/s/ Vincent J. Rubino, III

Alfred R. Fabricant

NY Bar No. 2219392

Email: ffabricant@fabricantllp.com

Peter Lambrianakos

NY Bar No. 2894392

Email: plambrianakos@fabricantllp.com

Vincent J. Rubino, III

NY Bar No. 4557435

Email: vrubino@fabricantllp.com

FABRICANT LLP

411 Theodore Fremd Road, Suite 206 South

Rye, NY 10580

Telephone: (212) 257-5797

Facsimile: (212) 257-5796

John Andrew Rubino
NY Bar No. 5020797
Email: jarubino@rubinoip.com
Michael Mondelli III
NY Bar No. 5805114
Email: mmondelli@rubinoip.com
RUBINO IP
51 J.F.K. Parkway
Short Hills, NJ, 07079
Telephone: (201) 341-9445
Facsimile: (973) 535-0921

***ATTORNEYS FOR PLAINTIFF,
LONGHORN AUTOMOTIVE
TECHNOLIGES LLC***