

IN THE UNITED STATES DISTRICT COURT
FOR THE SOUTHERN DISTRICT OF NEW YORK

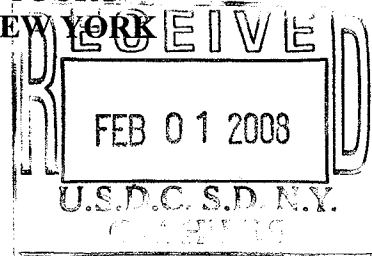

 PICTURE PATENTS, LLC,)
)
 Plaintiff,)
)
 v.)
)
 TERRA HOLDINGS, LLC,)
 HALSTEAD PROPERTY, LLC)
 BROWN HARRIS STEVENS, LLC)
)
 Defendants.)

Civil Case No. 07cv5465
 FIRST AMENDED COMPLAINT
 JURY TRIAL DEMAND

FIRST AMENDED COMPLAINT

Plaintiff Picture Patents LLC (hereinafter referred to as "Picture Patents") by and through undersigned counsel hereby brings this First Amended Complaint against Defendants Terra Holdings, LLC, Halstead Property, LLC and Brown Harris Stevens, LLC (hereinafter referred to collectively as "Terra Holdings" or "Defendants"), and alleges as follows:

THE PARTIES, JURISDICTION AND VENUE

1. Plaintiff Picture Patents, LLC is a limited liability company organized and existing under the laws of the State of Delaware, having a principal place of business at 325 Riverside Drive, New York, NY 10025. Picture Patents, LLC is a registered foreign limited liability company in the State of New York and is doing business in this State and District.

2. Upon information and belief, Terra Holdings, LLC ("Terra Holdings") is a limited liability company organized and existing under the laws of the State of New York, having a principal place of business located at 770 Lexington Avenue, 4th Floor, New York, New York, 10021 and has been and is doing business in the State of New York and within this District.

“Tweeter”) and Buy.com, Inc. (hereinafter referred to as “Buy.com”), (hereinafter referred to collectively as “Defendants”), and alleges as follows:

THE PARTIES, JURISDICTION AND VENUE

1. Plaintiff Picture Patents, LLC is a limited liability company organized and existing under the laws of the State of Delaware, having a principal place of business at 325 Riverside Drive, New York, NY 10025. Picture Patents, LLC is a registered foreign limited liability company in the State of New York and is doing business in this State and District.

2. Upon information and belief, Aeropostale, Inc. is a corporation organized and existing under the laws of the State of Delaware, having a principal place of business located at 112 West, 34th Street, 22nd Floor, New York, NY 10120. Upon information and belief, Aeropostale is also a registered foreign corporation in the State of New York. Aeropostale has been and is doing business in the State of New York and within this District, with a regular and established place of business located at 112 West, 34th Street, 22nd Floor, New York, NY 10120.

3. Upon information and belief, Dick’s Sporting Goods, Inc. is a corporation organized and existing under the laws of the State of Delaware, having a principal place of business located at 300 Industry Drive, Pittsburgh, PA 15275. Upon information and belief, Dick’s Sporting Goods is also a registered foreign corporation in the State of New York and Dick’s Sporting Goods has been and is doing business in the State of New York and within this District. Dick’s Sporting Goods may be served with process through its registered agent Corporation Service Company, 80 State Street, Albany, NY 12207-2543.

4. Upon information and belief, Bath & Body Works, LLC is a limited liability company organized and existing under the laws of the State of Delaware, having a principal

place of business located at 7 Limited Parkway E, Reynoldsburg, OH 43065-5300. Upon information and belief, Bath & Body Works is also a registered foreign limited liability company in the State of New York and Bath & Body Works has been and is doing business in the State of New York and within this District. Bath & Body Works may be served with process through its registered agent CT Corporation System, 111 Eighth Avenue, New York, NY 10011.

5. Upon information and belief, The Charlotte Russe, Inc. is a corporation organized and existing under the laws of the State of New York, having a principal place of business located at 103 Combs Avenue, New York, NY 11598. Upon information and belief, Charlotte Russe has been and is doing business in the State of New York and within this District.

6. Upon information and belief, GSI Commerce Solutions, Inc. is a corporation organized and existing under the laws of the State of Pennsylvania, having a principal place of business located at 935 First Avenue, King of Prussia, PA 19406. Upon information and belief, GSI is also a registered foreign corporation in the State of New York and GSI has been and is doing business in the State of New York and within this District. GSI may be served with process through the New York Department of State at 935 First Avenue, King of Prussia, PA 19406.

7. Upon information and belief, National Basketball Association, Inc. is a not-for profit corporation organized and existing under the laws of the State of New York, having a principal place of business located at Olympic Tower, 645 5th Avenue, New York, NY 10022. Upon information and belief, NBA has been and is doing business in the State of New York and within this District.

8. Upon information and belief, Major League Baseball Enterprises, Inc. is a corporation organized and existing under the laws of the State of New York, having a principal

place of business located at 245 Park Avenue, New York, NY 10167. Upon information and belief, MLB has been and is doing business in the State of New York and within this District.

9. Upon information and belief, Linens 'n Things, Inc. is a corporation having a principal place of business located at 6 Brighton Road, Clifton, NJ 07015. Upon information and belief, Linens 'n Things has been and is doing business in the State of New York and within this District.

10. Upon information and belief, Tweeter Home Entertainment Group, Inc. is a corporation having a principal place of business located at 40 Pequot Way, Canton, MA 02021. Upon information and belief, Tweeter has been and is doing business in the State of New York and within this District.

11. Upon information and belief, Buy.com, Inc. is a corporation having a principal place of business located at 85 Enterprise Suite 100, Aliso Viejo, CA 92656. Upon information and belief, Buy.com has been and is doing business in the State of New York and within this District.

12. This action for infringement arises under the patent laws of the United States, including 35 U.S.C. §§ 271, 281 and 283-85, et seq.

13. This Court has jurisdiction over the subject matter of this action on at least the following grounds:

- a. 28 U.S.C. § 1331, this being a civil action arising under the laws of the United States;
- b. 28 U.S.C. § 1337(a), this being a civil action arising under an Act of Congress regulating commerce and protecting trade and commerce; and

- c. 28 U.S.C. § 1338(a), this being a civil action arising under an Act of Congress relating to patent rights.

14. This Court has personal jurisdiction over Defendants because, *inter alia*, upon information and belief, Defendants have conducted and at the time of the filing of this Complaint are conducting business in this State and District and otherwise has committed acts in this State and in this District that are the subjects of and/or related to the claims set forth herein.

15. Venue is properly laid in this Court under the provisions of 28 U.S.C. §§ 1391 and 1400(b).

CLAIMS FOR PATENT INFRINGEMENT

16. On August 21, 2001, United States Patent No. 6,278,455 (“the ’455 patent”) was duly and legally issued for a “Pictorial Interface For Accessing Information In An Electronic File System.” A true and correct copy of the ’455 patent is attached hereto as Exhibit “A” and made a part hereof.

17. Picture Patents, LLC is the owner, by assignment, of all right, title, and interest in the ’455 patent. Picture Patents has the right to bring and maintain the present action.

18. Upon information and belief, Aeropostale manufactures, makes, has made, uses, sells and/or offers for sale devices and/or services that infringe claims in the ’455 patent. Aeropostale is infringing directly, by inducement, and/or by contributing to the infringement of the ’455 patent by offering, providing, using and operating services through one or more websites, including but not limited to the “www.aeropostale.com” web site, including but not limited to providing a pictorial interface on said websites that permits access of electronic files. Aeropostale has committed these acts of infringement throughout the United States, including in this judicial district.

19. Upon information and belief, Aeropostale has committed acts of willful infringement as it had notice of the '455 patent and notice that it was infringing the '455 patent when it was served with the original complaint alleging infringement, and to date, Aeropostale has not removed the infringing material off of its website and it continues to infringe the '455 patent.

20. Plaintiff has been damaged as a result of Aeropostale's infringing conduct.

21. Upon information and belief, Dick's Sporting Goods manufactures, makes, has made, uses, sells and/or offers for sale devices and/or services that infringe claims in the '455 patent. Dick's Sporting Goods is infringing directly, by inducement, and/or by contributing to the infringement of the '455 patent by offering, providing, using and operating services through one or more websites, including but not limited to the "www.dickssportinggoods.com" web site, including but not limited to providing a pictorial interface on said websites that permits access of electronic files. Dick's Sporting Goods has committed these acts of infringement throughout the United States, including in this judicial district.

22. Plaintiff has been damaged as a result of Dick's Sporting Goods' infringing conduct.

23. Upon information and belief, Bath & Body Works manufactures, makes, has made, uses, sells and/or offers for sale devices and/or services that infringe claims in the '455 patent. Bath & Body Works is infringing directly, by inducement, and/or by contributing to the infringement of the '455 patent by offering, providing, using and operating services through one or more websites, including but not limited to the "www.bathandbodyworks.com," web site, including but not limited to providing a pictorial interface on said websites that permits access of

electronic files. Bath & Body Works has committed these acts of infringement throughout the United States, including in this judicial district.

24. Plaintiff has been damaged as a result of Bath & Body Works' infringing conduct.

25. Upon information and belief, Charlotte Russe manufactures, makes, has made, uses, sells and/or offers for sale devices and/or services that infringe claims in the '455 patent. Charlotte Russe is infringing directly, by inducement, and/or by contributing to the infringement of the '455 patent by offering, providing, using and operating services through one or more websites, including but not limited to the "www.charlotterusse.com," web site, including but not limited to providing a pictorial interface on said websites that permits access of electronic files. Charlotte Russe has committed these acts of infringement throughout the United States, including in this judicial district.

26. Plaintiff has been damaged as a result of Charlotte Russe's infringing conduct.

27. Upon information and belief, GSI manufactures, makes, has made, uses, sells and/or offers for sale devices and/or services that infringe claims in the '455 patent. GSI is infringing directly, by inducement, and/or by contributing to the infringement of the '455 patent by offering, providing, using and operating services through one or more websites, including but not limited to the "www.fogdog.com," web site, including but not limited to providing a pictorial interface on said websites that permits access of electronic files. GSI has committed these acts of infringement throughout the United States, including in this judicial district.

28. Upon information and belief, GSI has been and is inducing the direct infringement of the '455 patent by the other defendants named herein.

29. Upon information and belief, GSI has committed acts of willful infringement as it had notice of the '455 patent and notice that it was infringing the '455 patent when it was given

notice by Aeropostale, and to date, GSI has not removed the infringing material off of its website and it continues to infringe the '455 patent.

30. Plaintiff has been damaged as a result of GSI's infringing conduct.

31. Upon information and belief, NBA manufactures, makes, has made, uses, sells and/or offers for sale devices and/or services that infringe claims in the '455 patent. NBA is infringing directly, by inducement, and/or by contributing to the infringement of the '455 patent by offering, providing, using and operating services through one or more websites, including but not limited to the "www.nba.com," web site, including but not limited to providing a pictorial interface on said websites that permits access of electronic files. NBA has committed these acts of infringement throughout the United States, including in this judicial district.

32. Plaintiff has been damaged as a result of NBA's infringing conduct.

33. Upon information and belief, MLB manufactures, makes, has made, uses, sells and/or offers for sale devices and/or services that infringe claims in the '455 patent. MLB is infringing directly, by inducement, and/or by contributing to the infringement of the '455 patent by offering, providing, using and operating services through one or more websites, including but not limited to the "<http://mlb.mlb.com>," web site, including but not limited to providing a pictorial interface on said websites that permits access of electronic files. MLB has committed these acts of infringement throughout the United States, including in this judicial district.

34. Plaintiff has been damaged as a result of MLB's infringing conduct.

35. Upon information and belief, Linens 'n Things manufactures, makes, has made, uses, sells and/or offers for sale devices and/or services that infringe claims in the '455 patent. Linens 'n Things is infringing directly, by inducement, and/or by contributing to the infringement of the '455 patent by offering, providing, using and operating services through one

or more websites, including but not limited to the "www.lnt.com," web site, including but not limited to providing a pictorial interface on said websites that permits access of electronic files. Linens 'n Things has committed these acts of infringement throughout the United States, including in this judicial district.

36. Plaintiff has been damaged as a result of Linens 'n Things' infringing conduct.

37. Upon information and belief, Tweeter manufactures, makes, has made, uses, sells and/or offers for sale devices and/or services that infringe claims in the '455 patent. Tweeter is infringing directly, by inducement, and/or by contributing to the infringement of the '455 patent by offering, providing, using and operating services through one or more websites, including but not limited to the "www.tweeter.com," web site, including but not limited to providing a pictorial interface on said websites that permits access of electronic files. Tweeter has committed these acts of infringement throughout the United States, including in this judicial district.

38. Plaintiff has been damaged as a result of Tweeter's infringing conduct.

39. Upon information and belief, Buy.com manufactures, makes, has made, uses, sells and/or offers for sale devices and/or services that infringe claims in the '455 patent. Buy.com is infringing directly, by inducement, and/or by contributing to the infringement of the '455 patent by offering, providing, using and operating services through one or more websites, including but not limited to the "www.buy.com," web site, including but not limited to providing a pictorial interface on said websites that permits access of electronic files. Buy.com has committed these acts of infringement throughout the United States, including in this judicial district.

40. Plaintiff has been damaged as a result of Buy.com's infringing conduct.

JURY DEMAND

41. Plaintiff hereby requests a trial by jury pursuant to Rule 38 of the Federal Rules of Civil Procedure.

PRAYER

42. WHEREFORE, Plaintiff respectfully requests that the Court find in its favor and against Defendants and the Court enter a judgment or order granting Plaintiff the following relief:

- a. That one or more claims of United States Patent No. 6,278,455 have been infringed, either literally and/or under the doctrine of equivalents, by Defendants and/or by others to whose infringement has been contributed to by Defendants and/or by others whose infringement has been induced by Defendants;
- b. That Defendants account for and pay to Plaintiff damages caused by Defendants' infringing activities complained of herein;
- c. That Plaintiff be granted pre-judgment and post-judgment interest at the maximum rate allowable by law on the damages caused by reason of Defendants' infringing activities complained of herein;
- d. That Plaintiff be awarded costs;
- e. That the infringement of Defendants Aeropostale, Inc. and GSI Commerce Solutions, Inc. be declared willful;
- f. That Plaintiff be granted additional damages up to three times the amount found or assessed as authorized by 28 U.S.C. §284 against Defendants Aeropostale, Inc. and GSI Commerce Solutions, Inc.;

- g. That Defendants be permanently enjoined from any conduct or activity that infringes United States Patent No. 6,278,455; and
- h. That Plaintiff be granted such other and further relief, both legal and equitable, as the Court may deem is just and proper under the circumstances.

Respectfully submitted this 1st day of February, 2008.

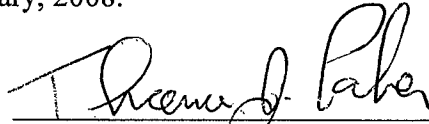

Thomas J. Parker (Bar No. TP-7219)
ALSTON & BIRD LLP
90 Park Avenue
New York, NY 10016
(212) 210-9400

ATTORNEYS FOR PLAINTIFF
Picture Patents, LLC

Exhibit A

(12) **United States Patent**
Baker

(10) **Patent No.: US 6,278,455 B1**
 (45) **Date of Patent: *Aug. 21, 2001**

(54) **PICTORIAL INTERFACE FOR ACCESSING INFORMATION IN AN ELECTRONIC FILE SYSTEM**

(76) **Inventor: Michelle Baker, 325 Riverside Dr., Apt #123, New York, NY (US) 10025**

(*) **Notice:** Subject to any disclaimer, the term of this patent is extended or adjusted under 35 U.S.C. 154(b) by 0 days.

This patent is subject to a terminal disclaimer.

(21) **Appl. No.: 09/459,934**

(22) **Filed: Dec. 13, 1999**

Related U.S. Application Data

(63) Continuation of application No. 09/003,553, filed on Jan. 6, 1998, now Pat. No. 6,002,401, which is a continuation of application No. 08/316,518, filed on Sep. 30, 1994, now Pat. No. 5,715,416.

(51) **Int. Cl.⁷ G06F 3/14**

(52) **U.S. Cl. 345/349; 345/335; 345/473**

(58) **Field of Search 345/348, 349, 345/350, 351, 346, 356, 357, 335, 977, 968, 302, 113, 115, 121, 473, 435**

(56) **References Cited**

U.S. PATENT DOCUMENTS

4,601,003	*	7/1986	Yoneyama et al.	345/351
5,021,976	*	6/1991	Wexelblat et al.	345/356
5,241,671	*	8/1993	Reed et al.	707/104
5,347,628	*	9/1994	Brewer et al.	345/351
5,349,658	*	9/1994	O'Rourke et al.	345/349
5,361,173	*	11/1994	Ishii et al.	360/27
5,394,521	*	2/1995	Henderson, Jr. et al.	345/346
5,442,736	*	8/1995	Cummins	345/434
5,479,602	*	12/1995	Baecker et al.	345/349
5,524,195	*	6/1996	Clanton, III et al.	345/327
5,657,462	*	8/1997	Brouwer et al.	345/336
5,682,469	*	10/1997	Linnett et al.	345/473

OTHER PUBLICATIONS

The Complete HyperCard 2.0 Handbook, 3rd Edition, Danny Goodman, Aug. 1990, pp. 165-168; 170-172; 313-319; and 400-402.

* cited by examiner

Primary Examiner—Crescelle N. dela Torre
(74) Attorney, Agent, or Firm—David P. Gordon; David S. Jacobson; Thomas A. Gallagher

(57) **ABSTRACT**

A pictorial user interface for accessing information in an electronic file system provides a pictorial image which is linked to a file directory and which identifies the file directory. Objects in the pictorial image are icons linked to file objects and an animated character is overlaid on the pictorial image. User input causes movement of the animated character relative to the pictorial image. Input from the user is preferably through a limited input device such as a gamepad controller, a mouse, or by using a limited number of keys on a normal keyboard. Input signals are mapped according to keycode identical command sets, context arguments and selection arguments. Commands that can be invoked by the user include operating system commands, pictorial object commands, and interface utility commands. Using the pictorial object commands, the user can configure the interface so that different pictures and icons are associated with different directories and files. Commands are executed with a prologue animation and an epilogue animation. The prologue animation provides feedback as to the nature of the command being executed. The epilogue animation provides feedback as to the results of the command. Animations may include actions of the animated character or the behaviour of a selected icon, or both. The interface may be applied as an overlay to virtually any operating system.

11 Claims, 18 Drawing Sheets

Microfiche Appendix Included
 (1 Microfiche, 81 Pages)



FIG. 1

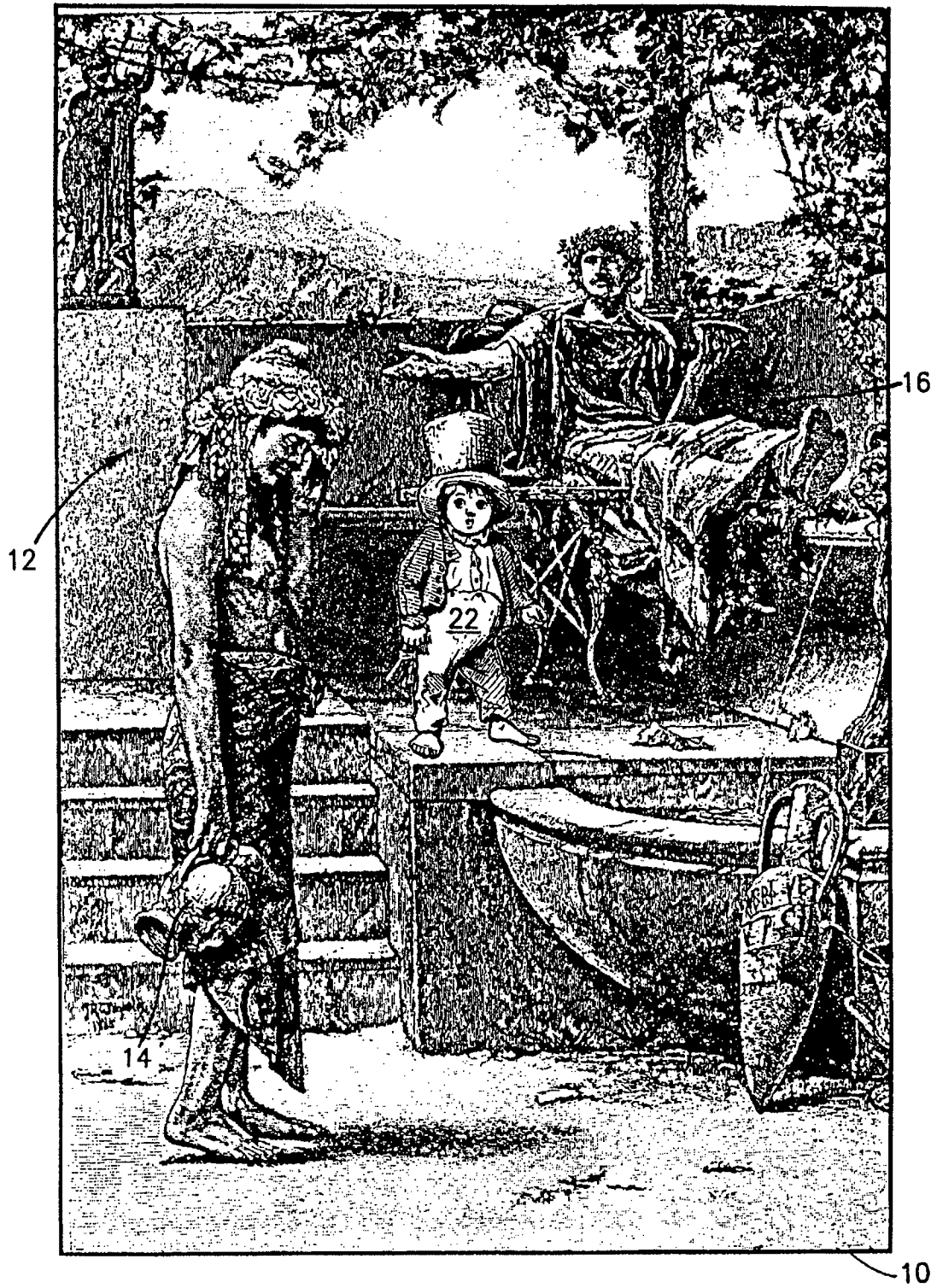

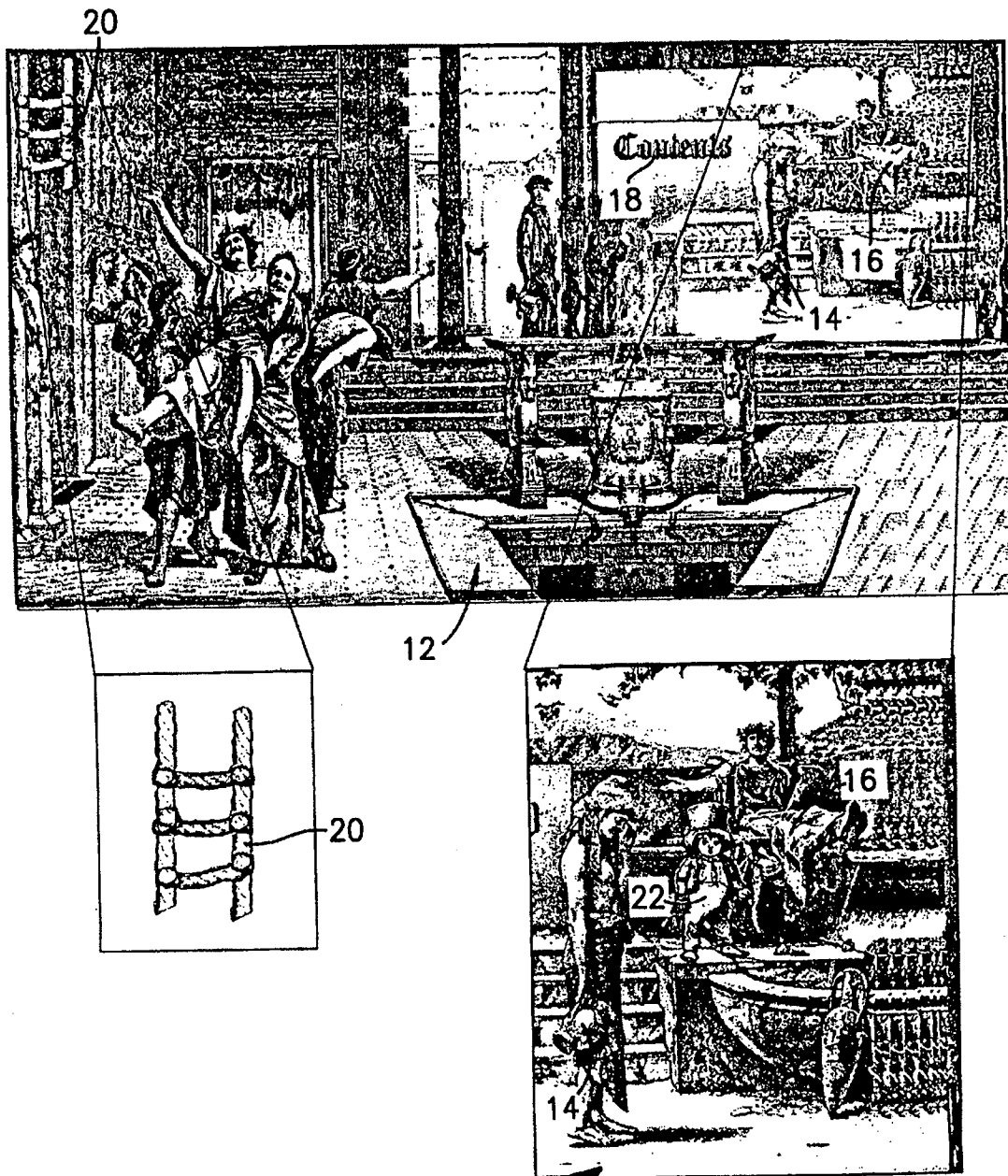

FIG. 1a

FIG. 2a

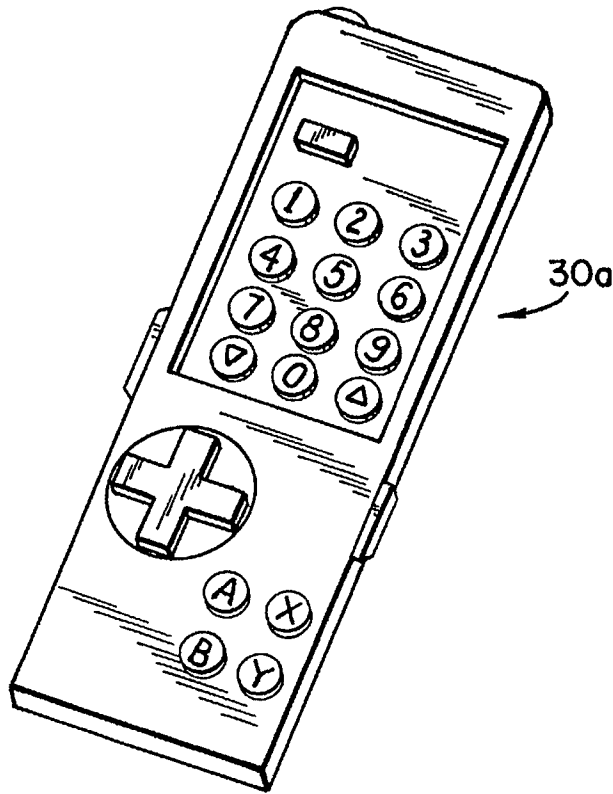

FIG. 2

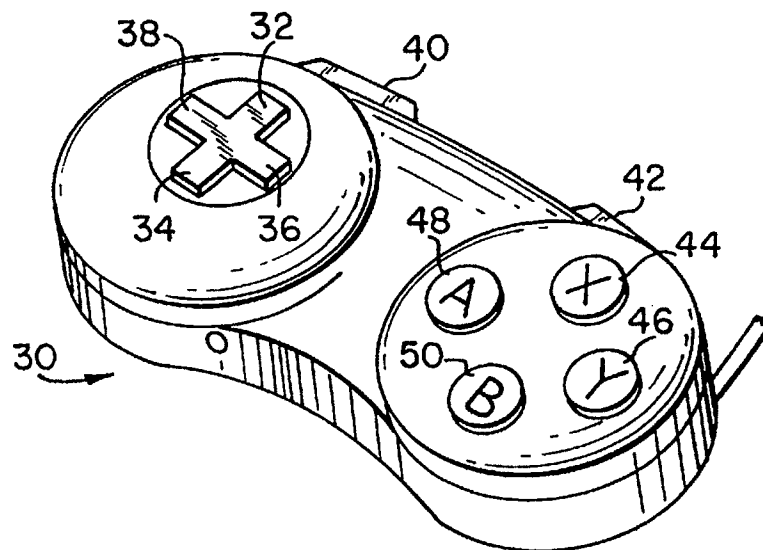



FIG. 3



FIG. 3a



FIG. 3b



FIG. 3c

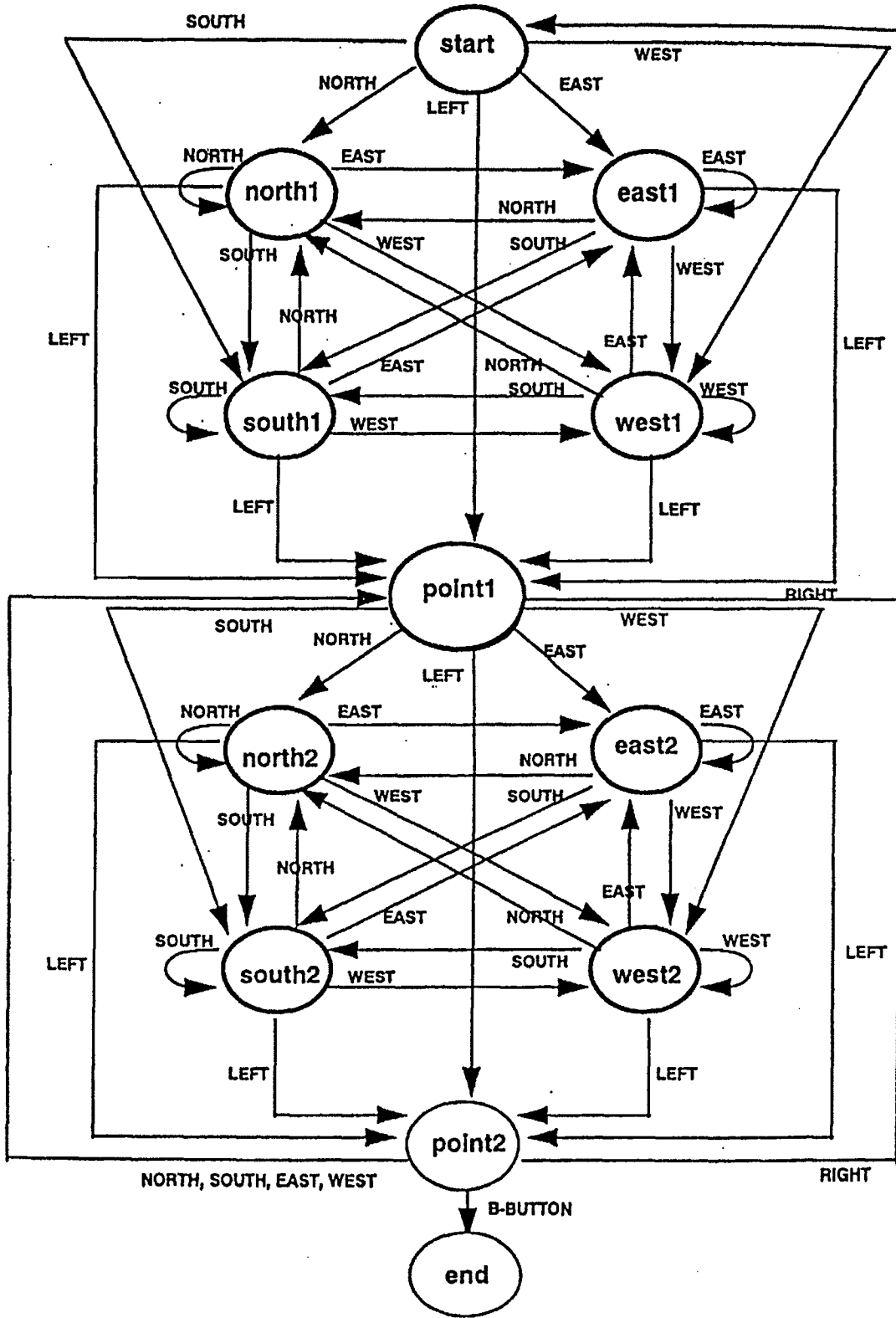

FIG. 3d

FIG. 3e

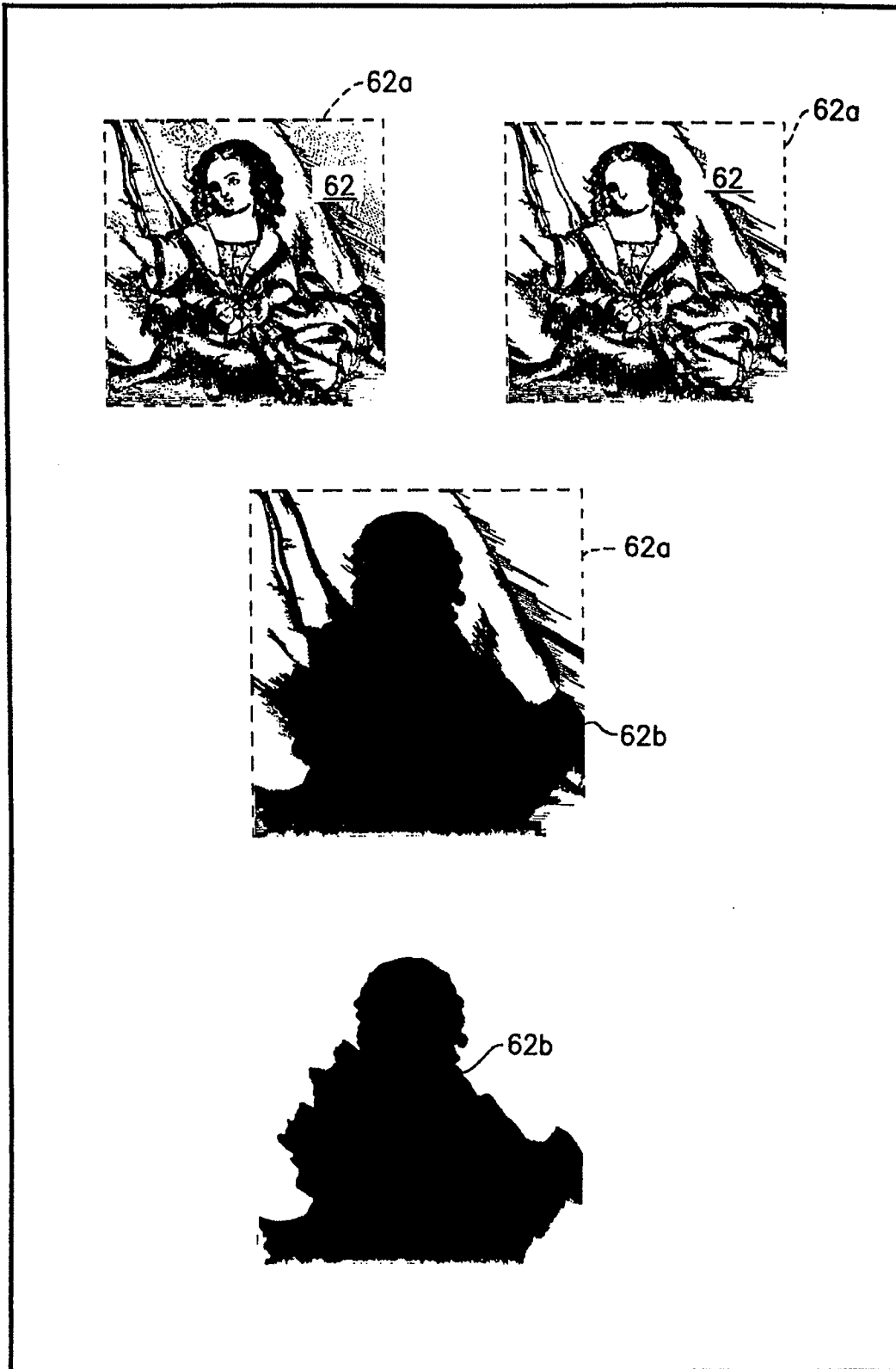
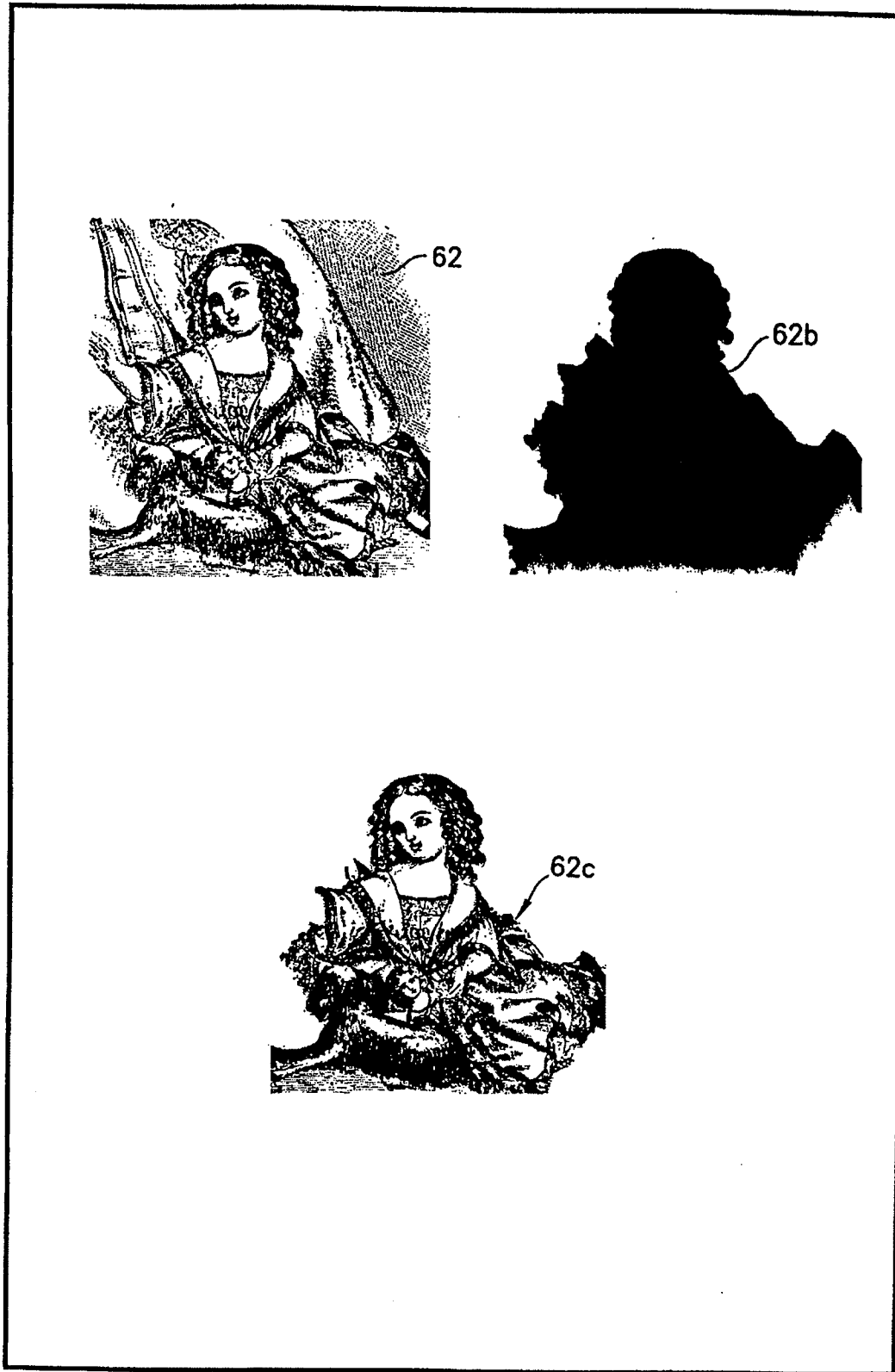

FIG. 3f



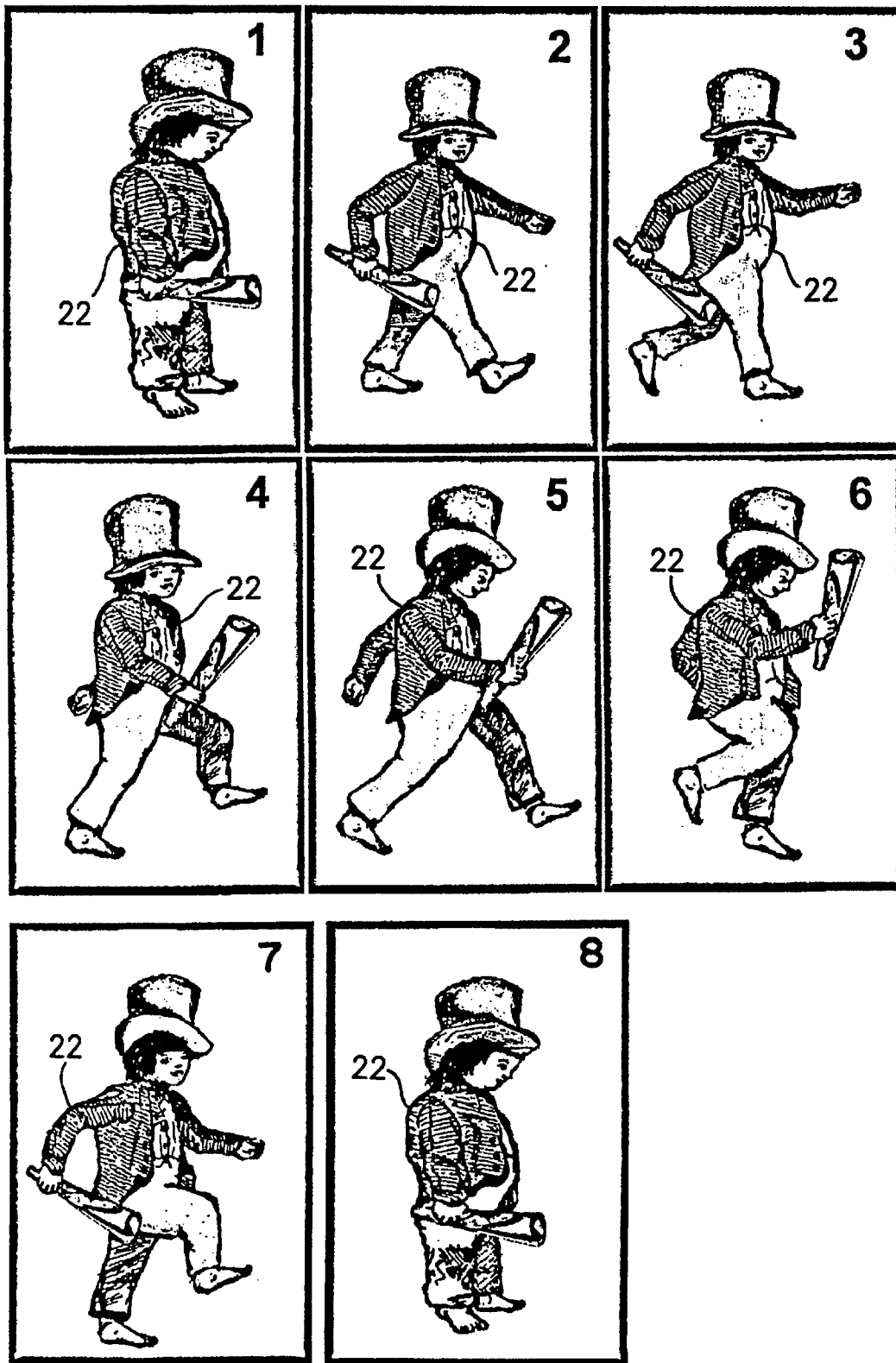

FIG. 4

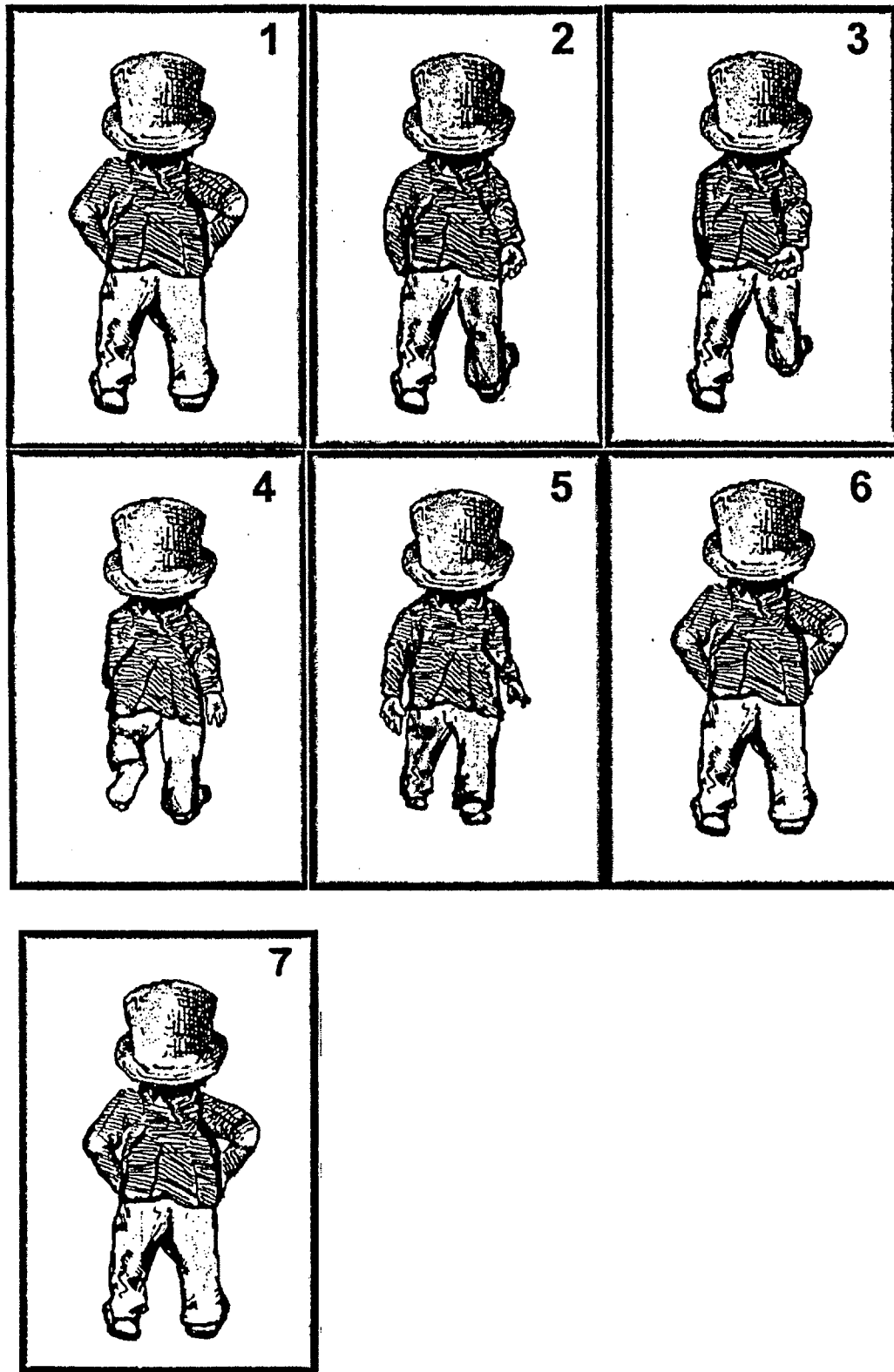

FIG. 4a

FIG. 4b

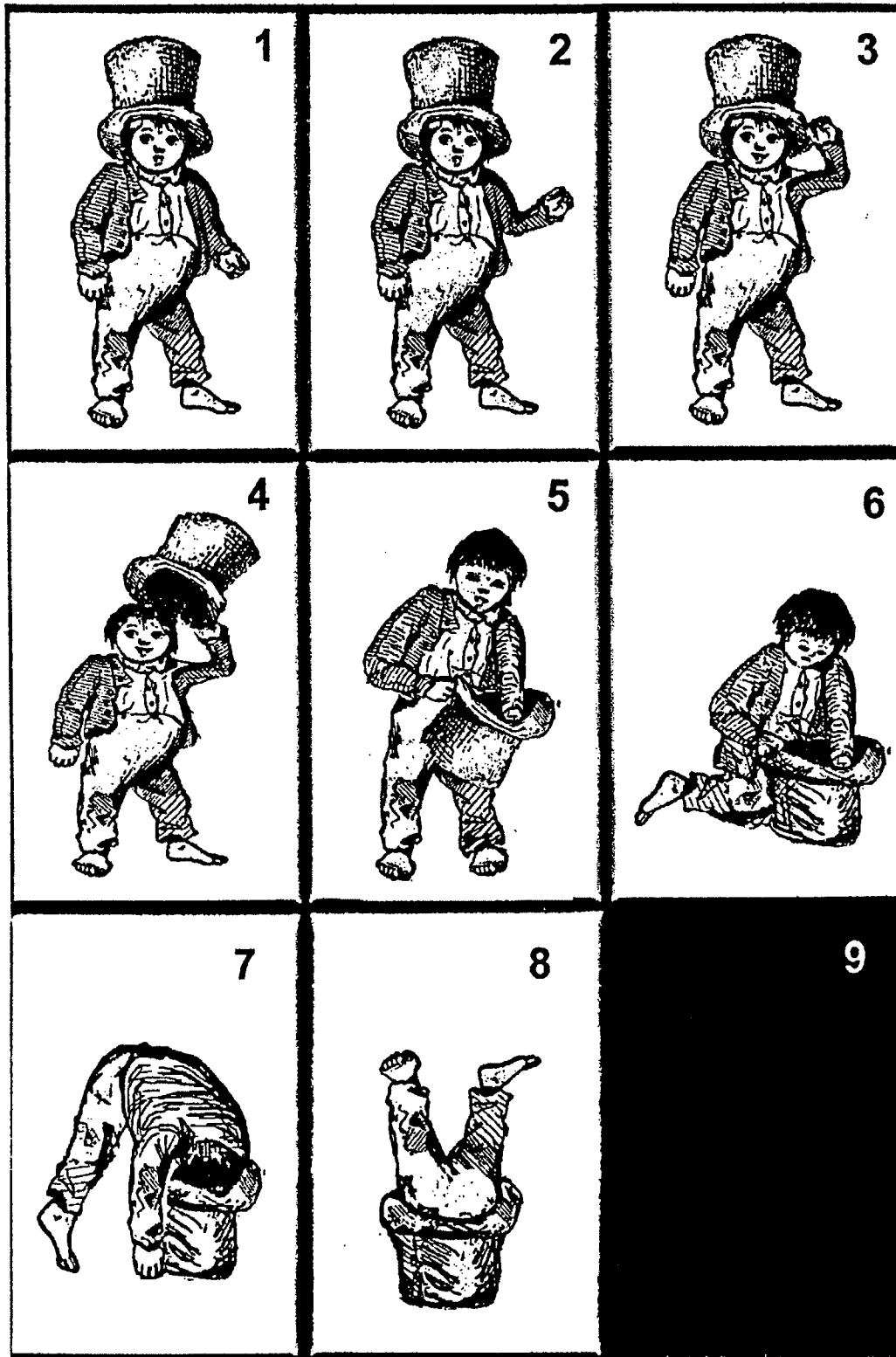
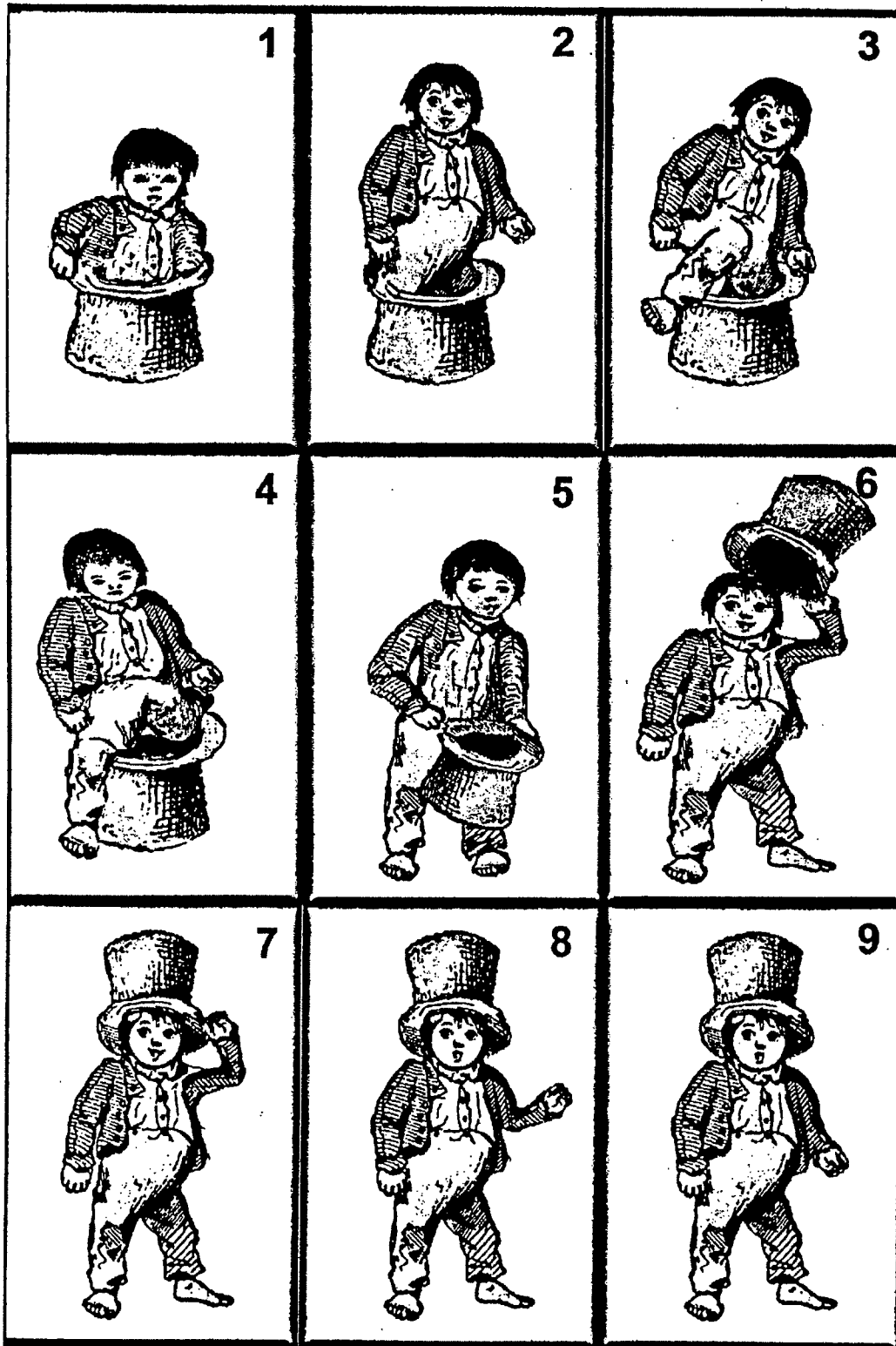

FIG. 4c



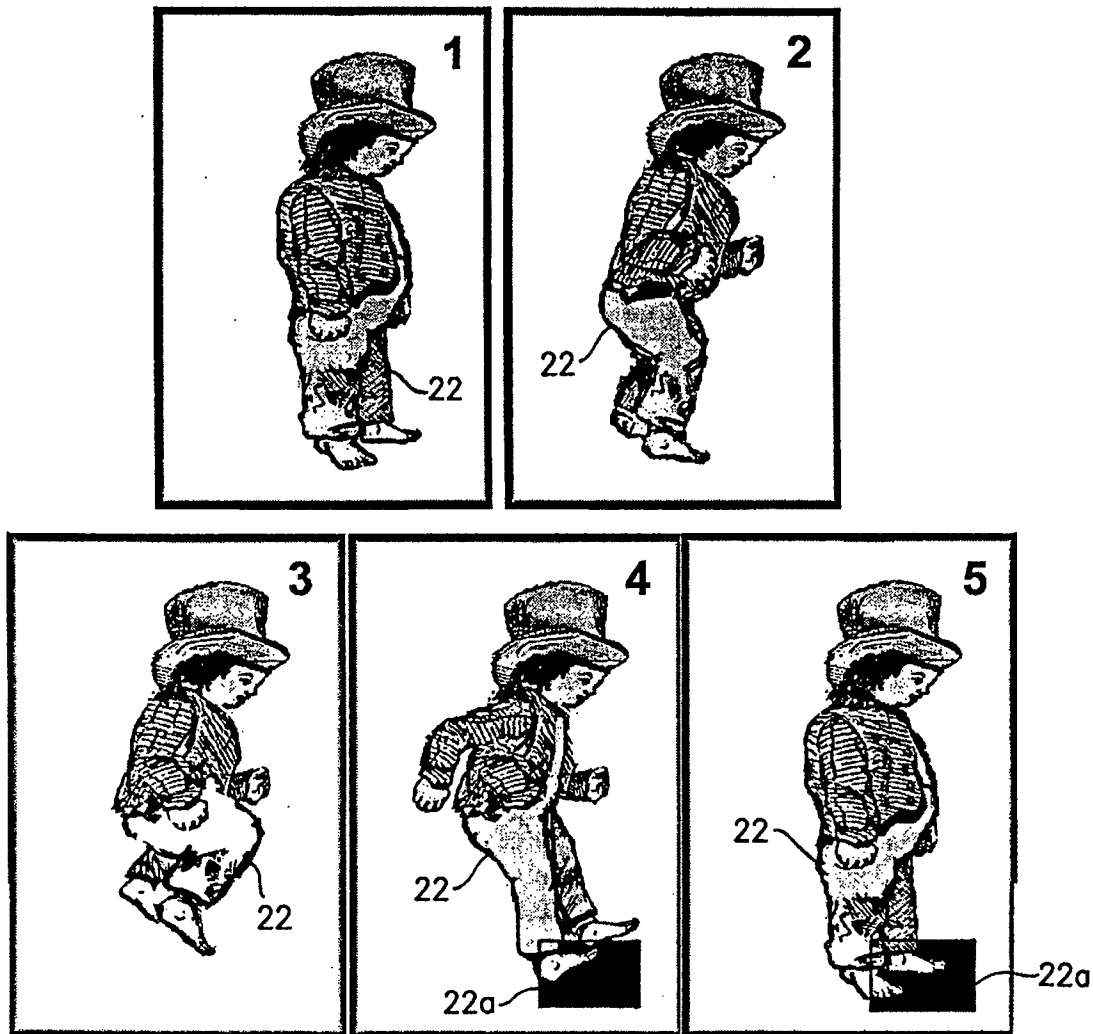
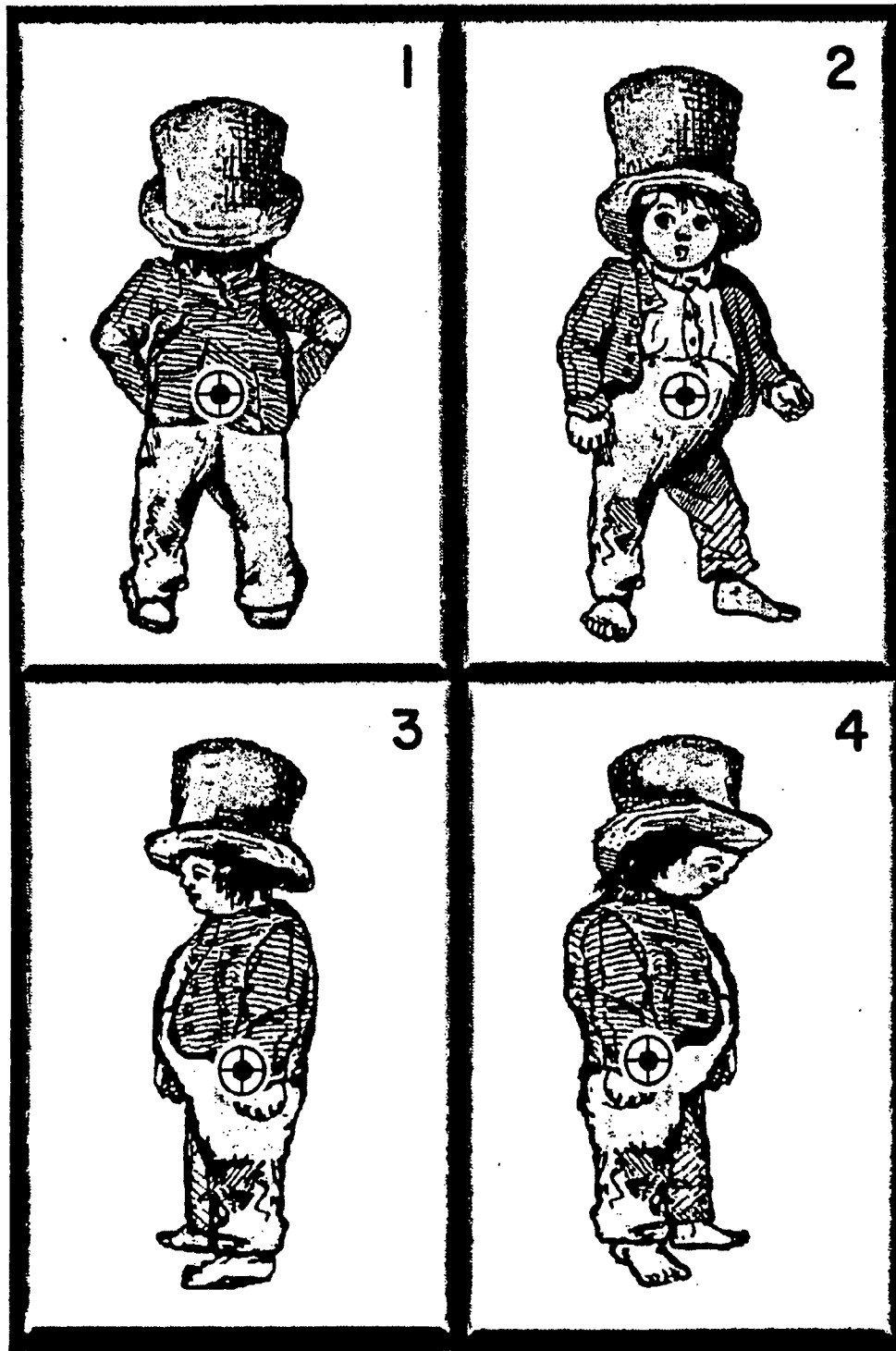

FIG. 4d

FIG. 5



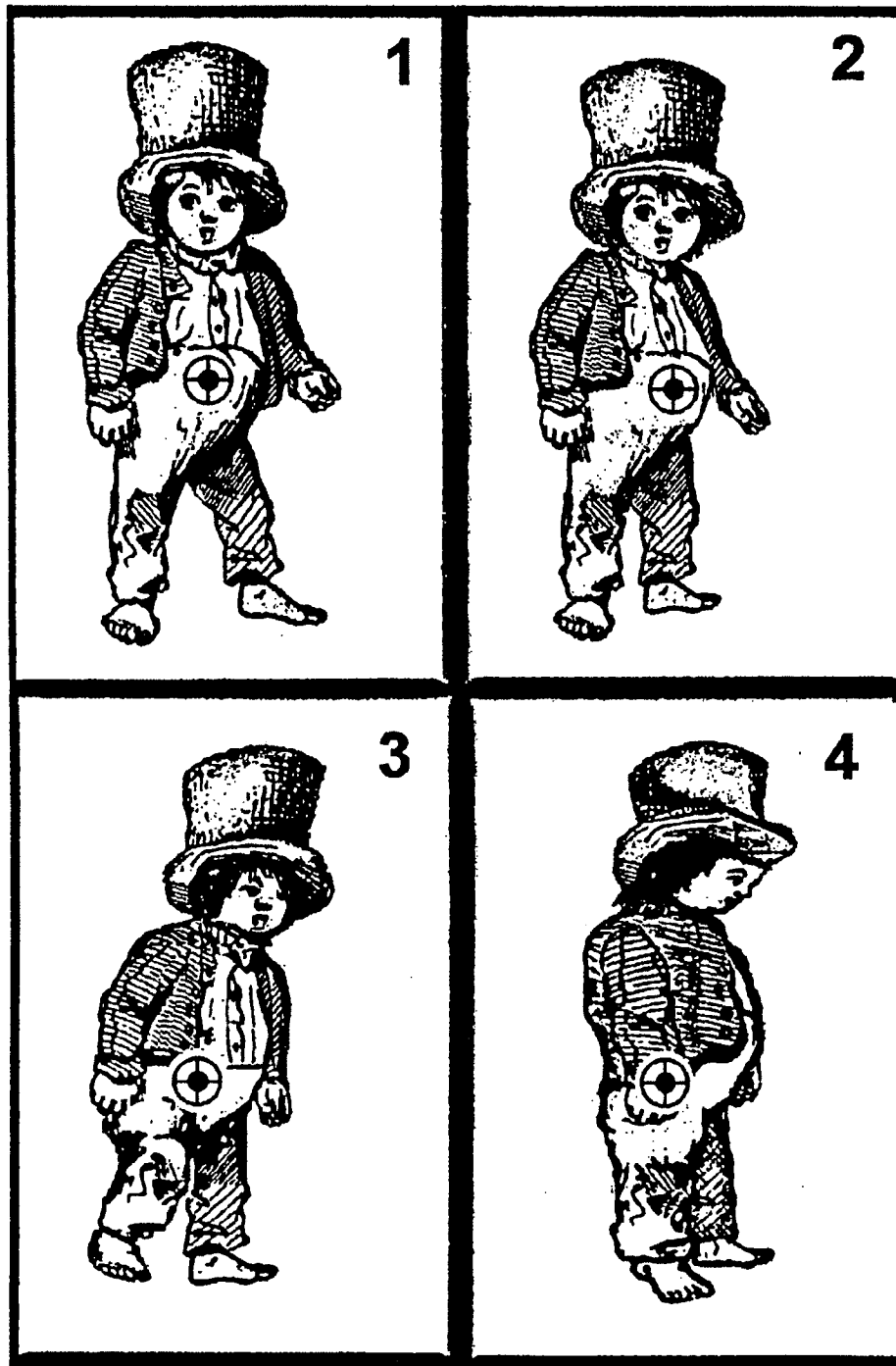

FIG. 5a