

1 BRETT J. WILLIAMSON (S.B. #145235)
bwilliamson@omm.com
2 GEOFFREY H. YOST (S.B. #159687)
gyost@omm.com
3 O'MELVENY & MYERS LLP
610 Newport Center Drive, 17th Floor
4 Newport Beach, CA 92660
Telephone: (949) 760-9600
5 Facsimile: (949) 823-6994

6 OF COUNSEL:

7 WILLIAM C. NORVELL, JR.
wcnorvell@bmpllp.com
8 SCOTT D. MARRS
smarrs@bmpllp.com
9 BEIRNE, MAYNARD & PARSONS L.L.P.
1300 Post Oak Boulevard, Suite 2500
10 Houston, Texas 77056
Telephone: (713) 623-0887
11 Facsimile: (713) 960-1527

12 Attorneys for Plaintiff
13 Richard A. Williamson, on behalf of and as
14 Trustee for At Home Bondholders'
Liquidating Trust

15 **UNITED STATES DISTRICT COURT**
16 **CENTRAL DISTRICT OF CALIFORNIA**
17 **WESTERN DIVISION**

19 RICHARD A. WILLIAMSON, ON
20 BEHALF OF AND AS TRUSTEE
21 FOR AT HOME BONDHOLDERS'
LIQUIDATING TRUST,

22 Plaintiff,

23 v.

24 BLACKBOARD INC.;
25 ELLUMINATE USA, INC.; and
WIMBA, INC.

26 Defendants.
27
28

CV12-04335-JAK(Ex)
Case No.

**COMPLAINT FOR PATENT
INFRINGEMENT**

JURY TRIAL DEMANDED

2012 MAY 18 PM 2:01
U.S. DISTRICT COURT
CENTRAL DISTRICT OF CALIFORNIA
WESTERN DIVISION

FILED

1 Plaintiff Richard A. Williamson, on behalf of and as Trustee for At Home
2 Bondholders' Liquidating Trust ("Plaintiff" or "At Home") alleges as follows:

3 **I. PARTIES AND SERVICE**

4 1. Plaintiff is Trustee of a liquidating trust formed under the confirmed
5 plan of reorganization for At Home Corporation in connection with its bankruptcy
6 filing on September 28, 2001, Case No. 01-32495-TC, in the United States
7 Bankruptcy Court for the Northern District of California, San Francisco Division.
8 Plaintiff's address is: Richard A. Williamson, Trustee of At Home Bondholders'
9 Liquidating Trust, Flemming Zulack Williamson Zauderer LLP, One Liberty Plaza,
10 New York, New York 10006-1404.

11 2. On information and belief, **Blackboard Inc.** is a Delaware corporation
12 with its principal place of business at 650 Massachusetts Avenue N.W., 6th Floor,
13 Washington, D.C. 20001-3796.

14 3. On information and belief, **Elluminate USA, Inc.** is a Delaware
15 corporation with its principal place of business at 4305 Hacienda Drive, Suite 520,
16 Pleasanton, California 94588. On information and belief, Elluminate USA, Inc.
17 was acquired by Blackboard Inc. on July 7, 2010.

18 4. On information and belief, **Wimba, Inc.** is a Delaware corporation
19 with its principal place of business at 10 East 40th St., Floor 11, New York, New
20 York 10016. On information and belief, Wimba, Inc. was acquired by Blackboard
21 Inc. on July 7, 2010.

22 5. Each of the defendants is hereafter collectively referred to as
23 Blackboard Defendants.

24 **II. JURISDICTION AND VENUE**

25 6. This action is for patent infringement under the Patent Laws of the
26 United States of America, 35 U.S.C. §§ 1 *et seq.*, including 35 U.S.C. § 271(a)-(c).
27 This Court has subject matter jurisdiction under 28 U.S.C. §§ 1331 (Federal
28

1 Question) and 1338(a) (Patents) because this is a civil action for patent
2 infringement arising under the United States patent statutes.

3 7. The Court has personal jurisdiction over Blackboard Defendants
4 because, upon information and belief, Blackboard Defendants have done business
5 in this judicial district, have continuous and systematic contacts within this district,
6 have committed and continue to commit acts of patent infringement in this judicial
7 district, and have harmed and continue to harm At Home in this judicial district by,
8 among other things, using infringing systems and/or methods in this judicial district
9 and/or offering for sale and selling classroom environment and streaming data
10 modules in this judicial district.

11 8. Venue is proper pursuant to 28 U.S.C. §§ 1391 and 1400 because,
12 among other reasons, Blackboard Defendants are subject to personal jurisdiction
13 and have committed acts of patent infringement in this judicial district.

14 9. On March 23, 2011, Plaintiff filed a complaint in this Court, styled
15 *Williamson v. Citrix Online, LLC et al.*, No. 2:11-cv-02409-AHM-JEM (C.D. Cal.),
16 against several entities, including Blackboard Defendants. In that litigation, the
17 Court entered a Scheduling and Case Management Order (D.I. 178) (Aug. 29,
18 2011) and a protective order (D.I. 213) (Jan. 25, 2012). Plaintiff and Blackboard
19 Defendants exchanged significant volumes of written discovery and document
20 productions, and Blackboard Defendants deposed the inventor of the '840 Patent.

21 10. On May 9, 2012, Plaintiff and Blackboard Defendants reached an
22 agreement to dismiss their claims and counterclaims against one another without
23 prejudice and that Plaintiff would file a new complaint in this venue against
24 Blackboard Defendants containing the same claims. On the same date, Blackboard
25 Defendants filed the corresponding Stipulation Of Dismissal Without Prejudice As
26 To Blackboard, Wimba, And Elluminate (D.I. 234).

27
28

1 **V. COUNT I – INFRINGEMENT OF THE '840 PATENT**

2 21. At Home restates and re-alleges each of the allegations contained in
3 paragraphs 1-20 of this Complaint, and incorporates them herein.

4 22. As set forth more fully below, Blackboard Defendants have infringed
5 and continue to infringe—directly, contributorily, and/or by active inducement—
6 one or more claims of the '840 patent by manufacturing, importing, offering to sell,
7 selling, supplying, causing to be supplied, using, and/or causing to be used systems
8 and/or methods that embody or practice the inventions claimed in the '840 patent
9 without authority and in violation of 35 U.S.C. § 271.

10 23. Blackboard Defendants have infringed and continue to infringe—
11 directly, contributorily, and/or by active inducement—one or more claims of the
12 '840 patent by manufacturing, importing, offering to sell, selling, supplying,
13 causing to be supplied, using, and/or causing to be used systems and/or methods
14 that embody or practice the inventions claimed in the '840 patent. For example,
15 Blackboard Defendants directly infringe the '840 patent by operating their server(s)
16 and/or database(s) to sell products and/or services related to web-based control,
17 classroom environment, and streaming data modules, or alternatively, indirectly
18 infringe the '840 patent by contributing to and/or actively inducing others to
19 operate server(s) and/or database(s) to sell products and/or services related to web-
20 based control, classroom environment, and streaming data modules. These
21 products and/or services, including, for example, Blackboard Collaborate,
22 Elluminate *Live!*, Wimba Classroom, Elluminate *Plan!*, Blackboard Collaborate
23 enterprise instant messaging, and Wimba Pronto, among others, infringe one or
24 more claims of the '840 patent. Blackboard Defendants are liable for their
25 infringement of the '840 patent pursuant to 35 U.S.C. § 271.

26 24. Blackboard Defendants' acts of infringement have caused damage to
27 At Home, and At Home is entitled to recover from Blackboard Defendants the
28 damages—in the form of a reasonable royalty—that At Home has sustained as a

1 result of the infringing acts. Moreover, Blackboard Defendants' infringement of
2 the '840 patent will continue to damage At Home, causing irreparable harm, unless
3 such infringement is enjoined.

4 25. Upon information and belief, Blackboard Defendants' infringement of
5 the '840 patent is willful and deliberate, entitling At Home to increased damages
6 under 35 U.S.C. § 284 and to attorneys' fees and costs incurred in prosecuting this
7 action under 35 U.S.C. § 285.

8 **VI. PRAYER FOR RELIEF**

9 At Home prays for the following judgment and relief:

10 A. Judgment that Blackboard Defendants have infringed the '840 patent;

11 B. An award of preliminary and permanent injunctions enjoining
12 Blackboard Defendants and their agents, servants, officers, directors, employees,
13 and persons or entities acting in concert with Blackboard Defendants from
14 infringing directly or indirectly, inducing others to infringe, and/or contributing to
15 the infringement of the '840 patent;

16 C. An award to At Home for the damages necessary to compensate it for
17 Blackboard Defendants' infringement of the '840 patent pursuant to 35 U.S.C. §
18 284;

19 D. An award to At Home of enhanced damages for the willful
20 infringement of the '840 patent pursuant to 35 U.S.C. § 284;

21 E. An award to At Home of its attorneys' fees, costs, expert witness fees,
22 and expenses incurred by it in connection with this action pursuant to 35 U.S.C.
23 § 285;

24 F. Pre-judgment and post-judgment interest; and

25 G. Any other and further relief, both general and special, at law or in
26 equity, to which At Home is entitled.

27 **REQUEST FOR JURY TRIAL**

28 Pursuant to Rule 38(b) of the Federal Rules of Civil Procedure, At Home

1 hereby demands a trial by jury of all issues in this action.

2

3

Dated: May 18, 2012

4

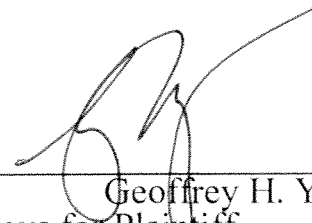
By: 
Geoffrey H. Yost
Attorneys for Plaintiff
Richard A. Williamson, on behalf of
and as Trustee for At Home
Bondholders' Liquidating Trust

5

6

7

8

9

10 OF COUNSEL:

11 WILLIAM C. NORVELL, JR.
12 wcnorvell@bmpllp.com
13 SCOTT D. MARRS
14 smarrs@bmpllp.com
15 BEIRNE, MAYNARD & PARSONS L.L.P.
16 1300 Post Oak Boulevard, Suite 2500
Houston, Texas 77056
Telephone: (713) 623-0887
Facsimile: (713) 960-1527

17

18

19

20

21

22

23

24

25

26

27

28

EXHIBIT A

United States Patent [19]

[11] **Patent Number:** **6,155,840**

Sallette

[45] **Date of Patent:** **Dec. 5, 2000**

[54] **SYSTEM AND METHOD FOR DISTRIBUTED LEARNING**

Primary Examiner—Jessica J. Harrison
Assistant Examiner—Chanda Harris
Attorney, Agent, or Firm—Fenwick & West LLP

[75] Inventor: **Alfred V. Sallette**, San Jose, Calif.

[57] **ABSTRACT**

[73] Assignee: **At Home Corporation**, Redwood City, Calif.

A system and method for distributed learning that includes a distributed learning server coupled to presenter and audience computer systems via a network such as the Internet. The distributed learning server includes control, classroom environment, and streaming data modules. The control module controls interactions between the presenter and audience computer systems, controls the operation of the classroom environment and streaming data modules, and authenticates the users of the presenter computer systems. The control module also allows the presenter to set up a presentation and pre-select streaming data sources that will be used in the presentation. The classroom environment module provides a classroom metaphor having a podium and rows of seats to the presenter and audience computer systems. The streaming data module allows multiple streaming data feeds, such as digital video, to be sent from one computer system coupled to the distributed learning server to the other computer systems. The presenter and audience computer systems are preferably industry-standard computer systems executing JAVA-compatible web browsers connected to the distributed learning server. The presenter computer system displays a content selection region for selecting among data feeds, a first streaming media region for showing a first selected data feed, and a second streaming media region for showing a second selected data feed. The audience member computer system displays a presentation/feedback region for viewing presentation text and providing feedback to the presenter and first and second streaming media regions for viewing the data feeds selected by the presenter.

[21] Appl. No.: **09/156,335**

[22] Filed: **Sep. 18, 1998**

[51] **Int. Cl.**⁷ **G09B 7/00**

[52] **U.S. Cl.** **434/323; 434/350; 434/362; 709/204; 709/203; 709/219; 709/231**

[58] **Field of Search** **434/350, 118, 434/362, 323, 345, 302, 328, 146; 709/1, 203, 204, 219, 231; 706/927; 707/502, 501**

[56] **References Cited**

U.S. PATENT DOCUMENTS

| | | | |
|-----------|---------|-------------------|-------------|
| 4,715,818 | 12/1987 | Shapiro et al. | 434/118 X |
| 4,785,472 | 11/1988 | Shapiro | 379/96 X |
| 5,002,491 | 3/1991 | Abrahamson et al. | 434/322 X |
| 5,295,836 | 3/1994 | Ryu et al. | 434/335 X |
| 5,318,450 | 6/1994 | Carver | 434/336 X |
| 5,347,306 | 9/1994 | Nitta | 348/15 X |
| 5,601,436 | 2/1997 | Sudman et al. | 434/307 R X |
| 5,727,950 | 3/1998 | Cook et al. | 434/350 |
| 5,782,642 | 7/1998 | Goren | 434/307 R X |
| 6,021,119 | 2/2000 | Derks et al. | 434/350 X |
| 6,064,856 | 6/2000 | Lee et al. | 434/350 X |
| 6,065,042 | 5/2000 | Reimer et al. | 709/203 X |
| 6,070,185 | 5/2000 | Anupam et al. | 709/204 X |
| 6,078,948 | 6/2000 | Podgorny | 709/204 X |

24 Claims, 7 Drawing Sheets

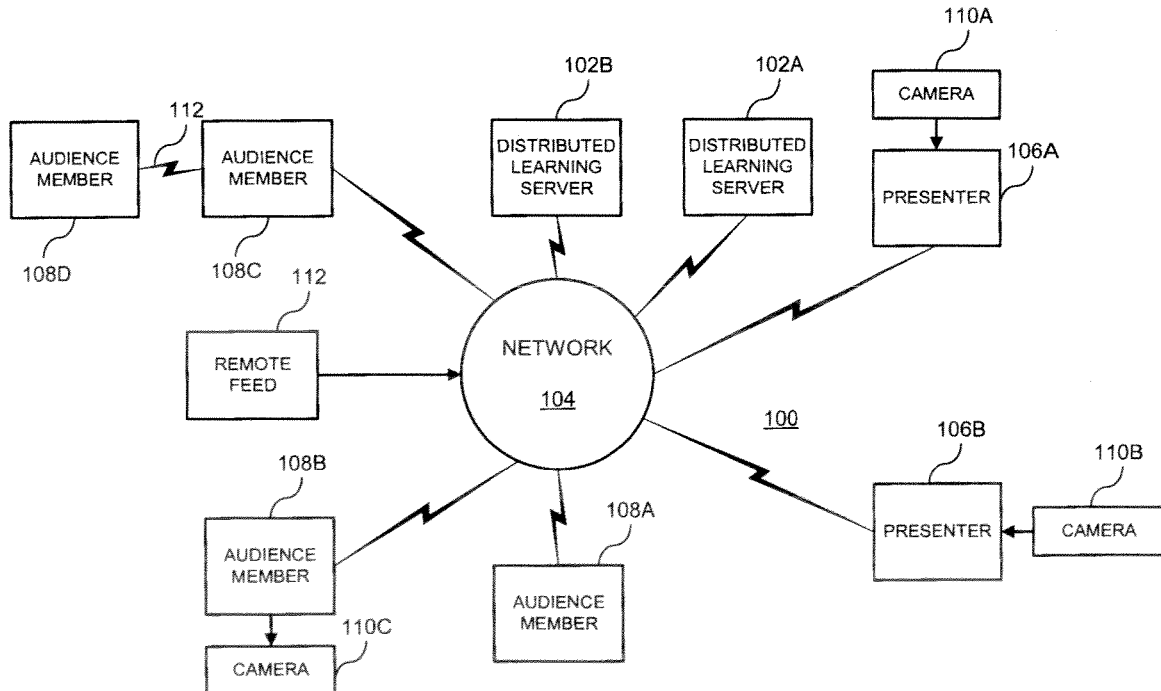

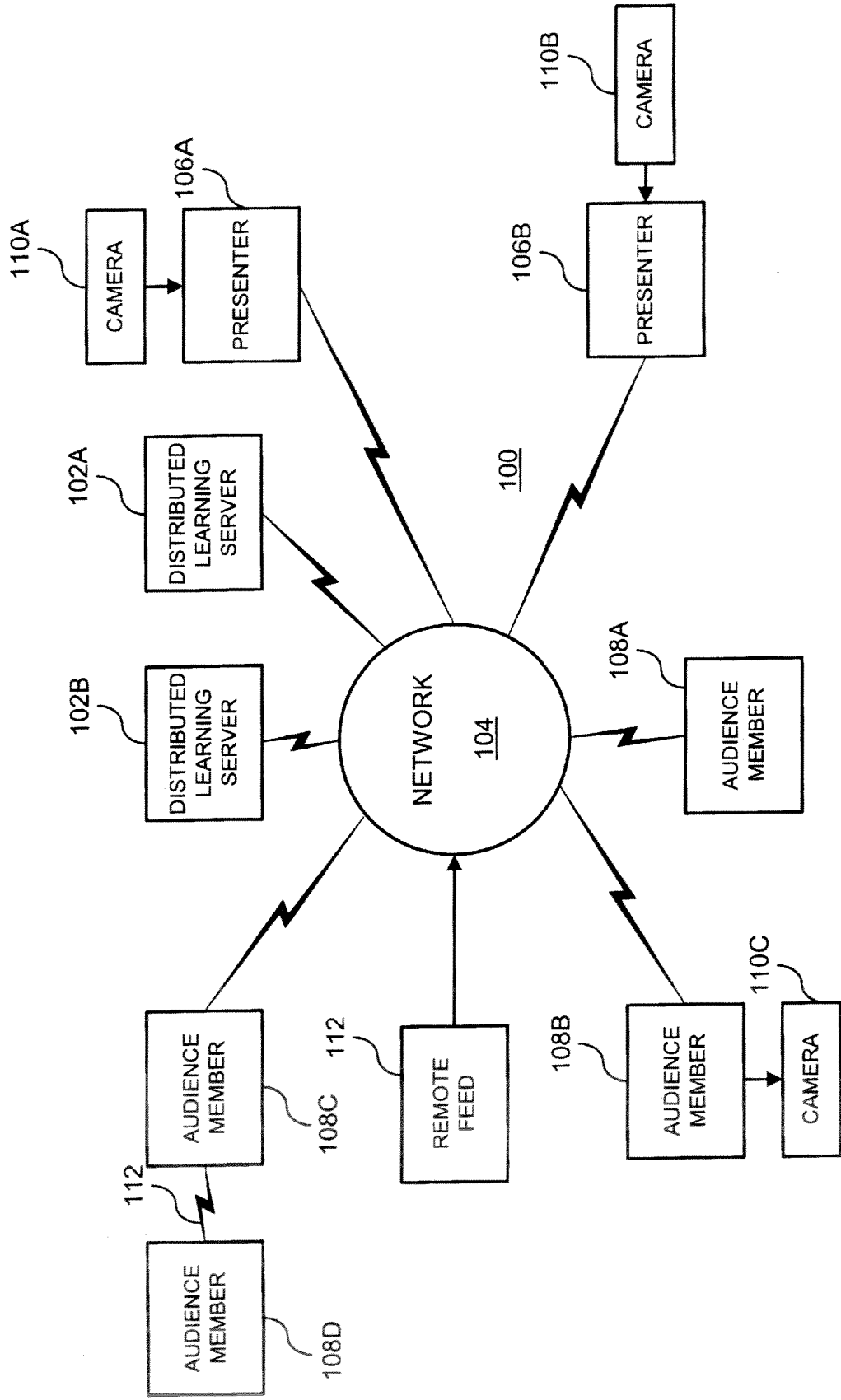

FIG. 1

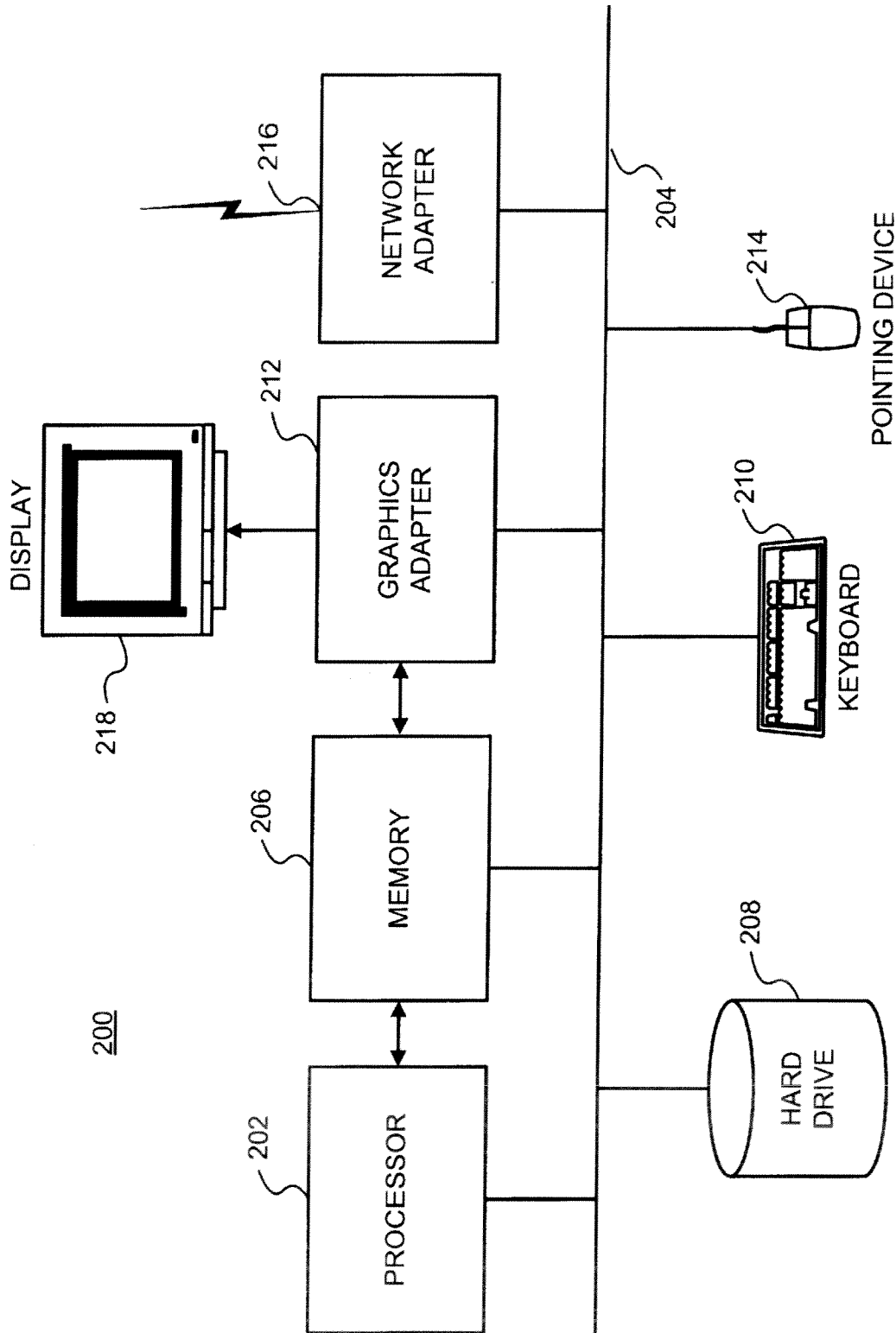

FIG. 2

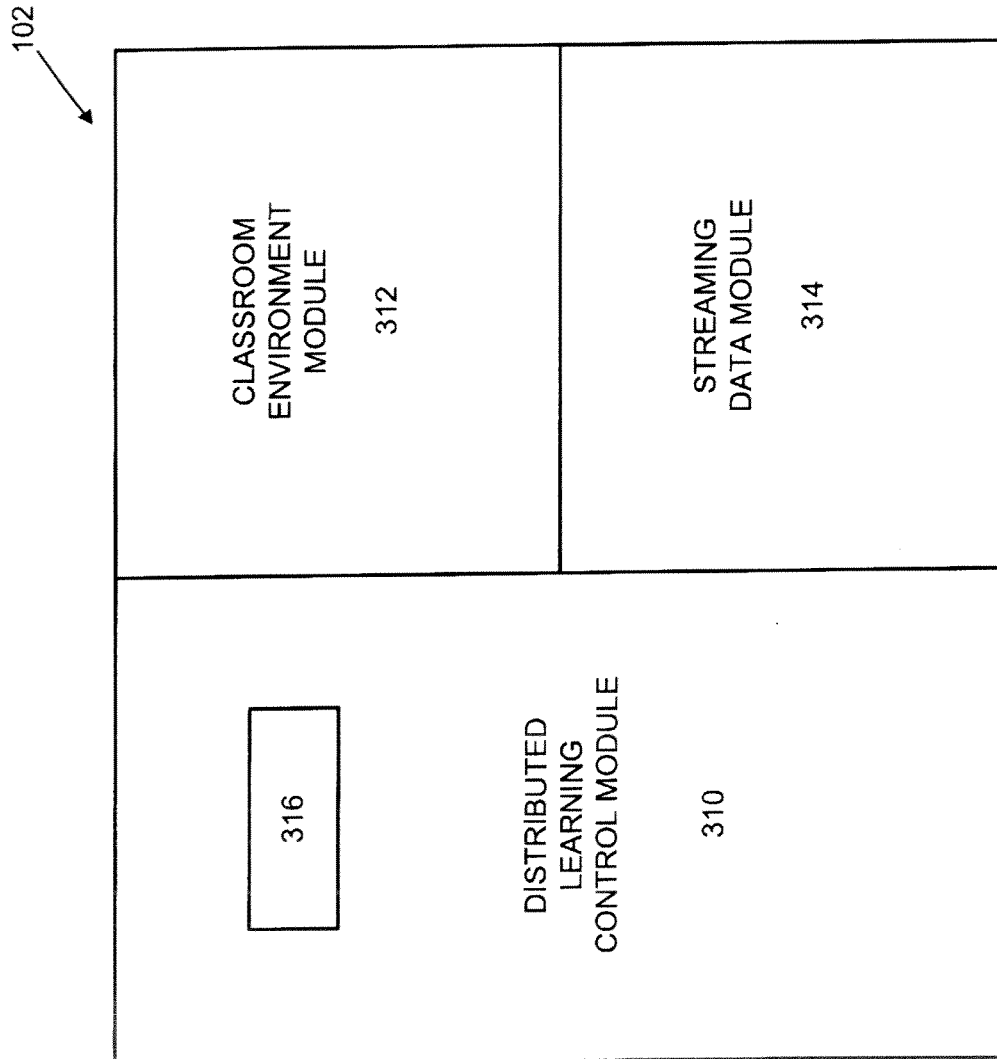

FIG.3

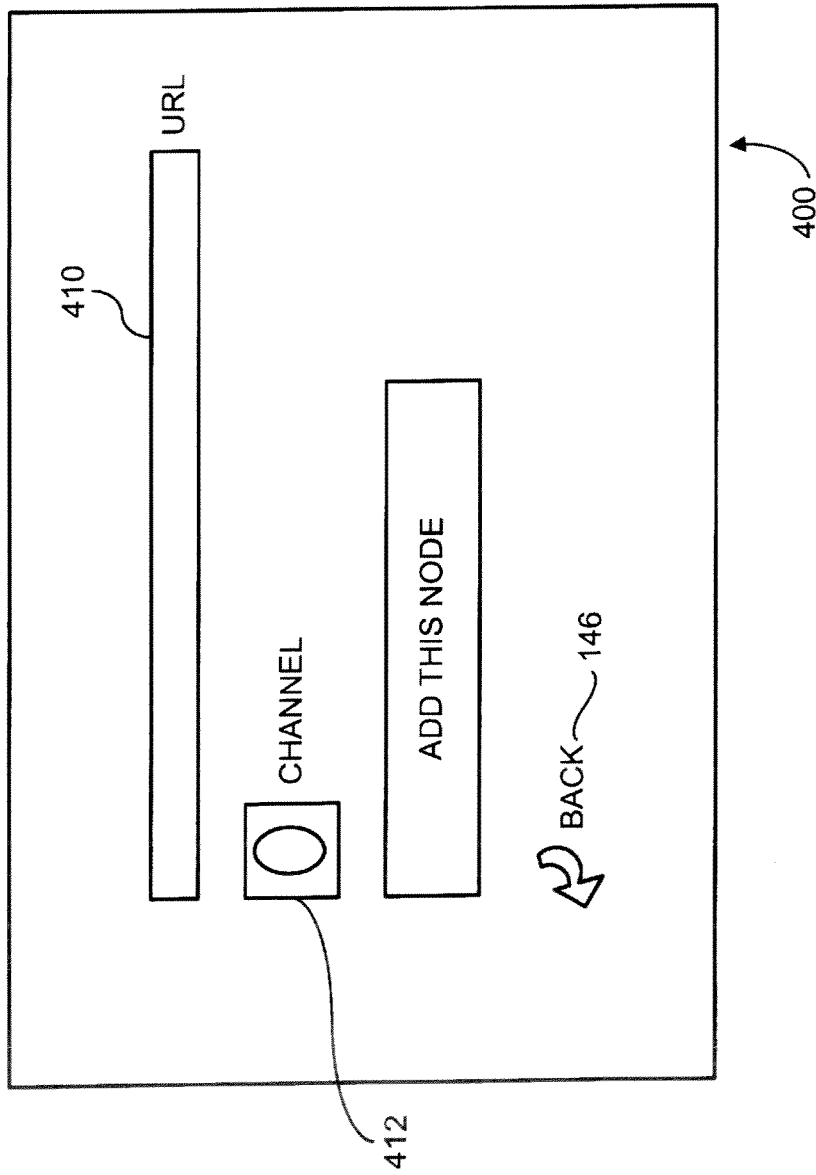

FIG. 4

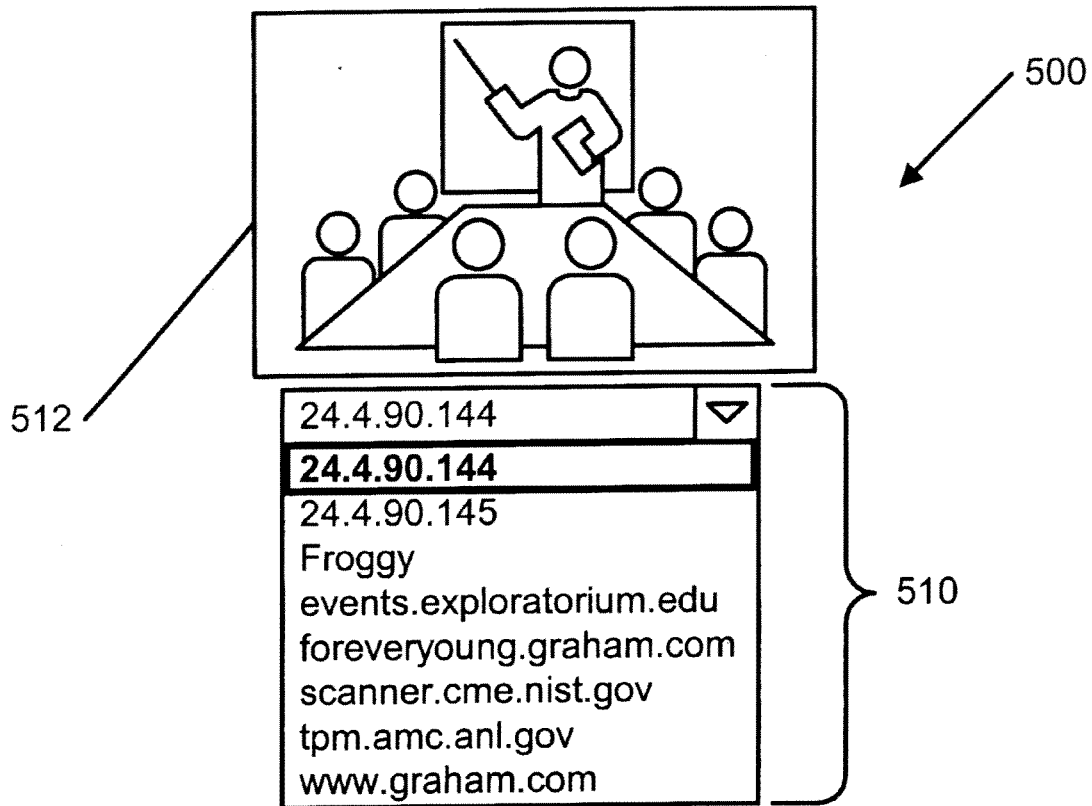

FIG. 5

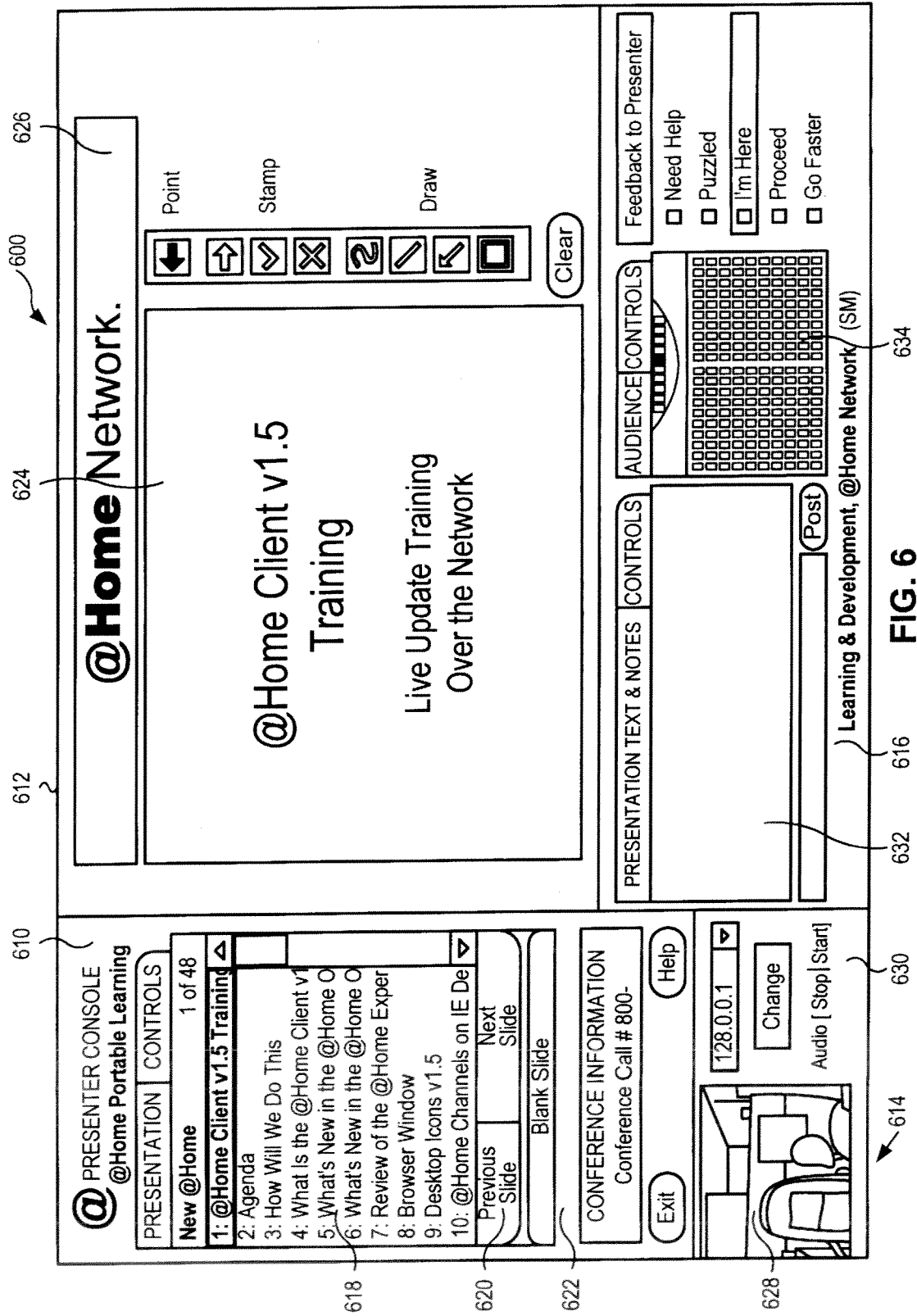
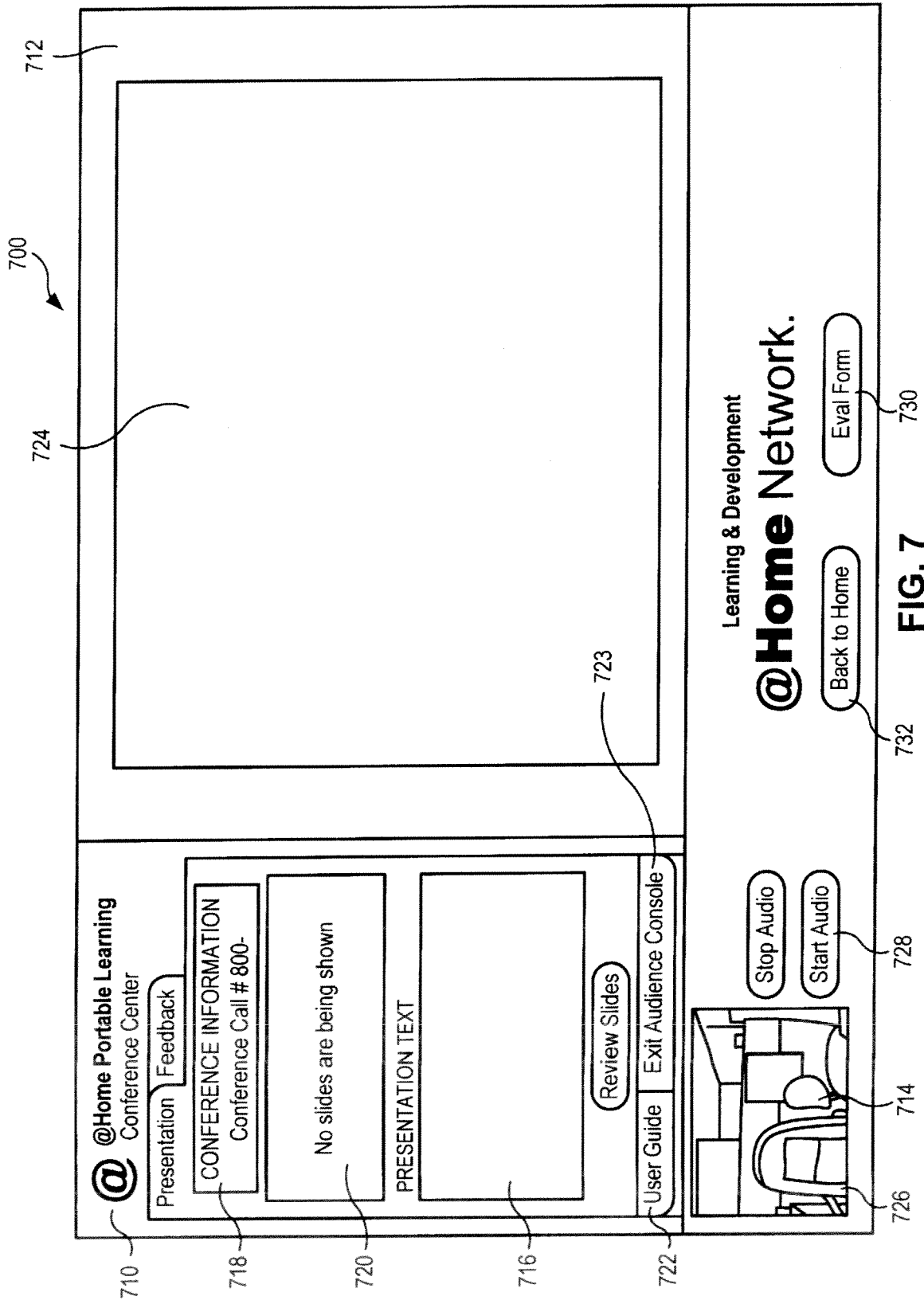

FIG. 6



6,155,840

1

SYSTEM AND METHOD FOR DISTRIBUTED LEARNING

BACKGROUND

1. Field of the Invention

This invention pertains in general to teaching and collaborative learning and in particular to a method and system for providing distributed skill-based training through the use of multiple streaming video feeds and data sharing over a network such as the Internet.

2. Background of the Invention

This present invention pertains to distributed skill-based training. Distributed training may occur in multiple locations simultaneously, like when a teacher teaches to multiple remote classrooms, or may occur in multiple locations independently, like when a user manual is released to the public. Often, such training is event-driven because it results from the occurrence of an event, like the completion of a project, that triggers a need to train people with certain skills. For example, once a software product is completed and released, there is typically a need to train people, including salespeople, technical support people, and users with the skills necessary to perform their roles. In another example, when a construction project, like the building of a dam or an airplane, is completed, there is a need to train people how to use the constructed asset.

Conventional training methods include providing manuals and/or classroom instruction. Manuals can be easily distributed to many people scattered in different locations. However, manuals are often not as effective as classroom instruction because the material may be boring and there is a lack of audience member-teacher-classroom interaction. Classroom instruction may be effective, but it is often difficult, costly, and inconvenient to arrange for many people from disparate locations to meet together for a training session.

To solve the problem of bringing people together, complex technologies have been developed to facilitate distributed learning. One such technology uses satellite broadcasts or other closed-circuit links to provide two-way video and audio communication between a teacher at a broadcast center with audience members at one or more remote classrooms. However, this solution is less than ideal because it requires specialized hardware to be present at the teacher's location and at each classroom.

Other solutions use specialized software programs executing on computer systems in an attempt to simulate the classroom experience. Since the software is specialized, each audience member must have access to the software and a network connection before connecting to the "classroom." This software is often expensive, resulting in a high cost to the audience member. In addition, the software may introduce compatibility and support problems.

Moreover, these solutions require the teachers and audience members to engage in unusual behavior that detracts from the learning experience. For example, some solutions do not support full-duplex communications and require the teachers and audience members to use a "walkie-talkie-" like communication interface.

Likewise, the audience members must devote time to learning the communications tools instead of learning the intended skills. All of the above-described problems are barriers to natural communication between the teachers and the audience members and often result in decreased learning. In order to provide an effective lesson, the teacher must be

2

an expert with the teaching tools in addition to the subject matter of the training.

Accordingly, there is a need for a system and method for distributed skills-based training that provides the benefits of classroom interaction without the detrimental effects of complicated hardware or software, or the costs and inconvenience of convening in a separate place.

SUMMARY OF THE INVENTION

The above needs are met by a distributed learning system that uses industry-standard computer hardware and software linked by a network like the Internet to provide a classroom- or auditorium-like metaphor to at least one presenter and at least one audience member. The distributed learning system can simultaneously support up to thousands of participants. The presenter uses a presenter computer system and the audience member uses an audience member computer system. Each of these computer systems is linked to at least one distributed learning server via the network.

The distributed learning server includes distributed learning control modules, classroom environment modules, and streaming data modules. Distributed learning control modules control the interactions between the other modules and the various presenter and audience computer systems coupled to the distributed learning server. In addition, distributed learning control modules provide security by authenticating the presenter and, if necessary, audience members. Distributed learning control modules also allow the presenter to pre-select sources of streaming data, such as digital video feeds, that will be used in the presentation. The pre-selected sources may be sources that are coupled to a presenter or audience member computer system or sources that are connected to the network through another means.

Classroom environment modules provide a classroom- or auditorium-like metaphor to the participants coupled to the distributed learning server. The classroom metaphor preferably provides a map of the classroom showing the relative relationships among presenters and audience members. The presenter can elicit feedback from the audience by asking questions, and the audience members can indicate responses by activating color-coded icons. In addition, audience members can "chat" among themselves or with presenters by exchanging text messages. The classroom environment modules also give the presenter the ability to control the content that appears on the audience members' computer systems.

The streaming data modules provide one or more streaming data feeds from the selected sources to the presenter and audience computer systems. In one embodiment, a digital video camera at the presenter computer system provides a streaming video image of the presenter to the distributed learning server. Upon the direction of the presenter, the streaming data module provides the video feed to the audience members' computer systems. If the presenter selects a different streaming data source, the presenter and the audience members' computer systems receive the different streaming data source.

The presenter and audience member computer systems are preferably industry-standard personal computer systems capable of browsing the World Wide Web on the Internet, executing JAVA instructions, and receiving data from the distributed learning server. The browser creates a display on the computer system that is divided into several different regions. The presenter computer system preferably displays content selection, first streaming media, second streaming media, and feedback regions. The content selection region

includes a tool allowing the presenter to select the streaming feed that appears in the first streaming media region and is sent to the audience member computer systems. Similarly, the second streaming media region includes a second streaming media content selection tool controlling the content shown in a second streaming media region. Preferably, the second streaming media feed uses less network bandwidth than the first streaming media window and may be used to support video feeds that would use prohibitively high bandwidth if sent at the same data rate as the first streaming media region. The feedback region preferably displays a graphical representation of the classroom and indicates feedback provided by the audience members.

The audience member computer system display preferably includes presentation/feedback, first streaming media, and second streaming media regions. The presentation/feedback region displays textual information provided by the presenter or another audience member. In addition, the presentation/feedback region displays feedback tools that the audience member can use to provide feedback to the presenter. The first and second streaming media regions display the content that the presenter selects using the first and second streaming media selection tools.

Preferably, the displays on the presenter and audience computer systems have a fixed browser window size and a minimum display resolution. In this manner, each type of participant can be assured of having an identical display. Such uniformity enhances the learning experience because it allows the participants to focus on the presentation, rather than concern themselves with the particularities of the computer system.

BRIEF DESCRIPTION OF THE DRAWINGS

FIG. 1 is a block diagram illustrating a typical hardware environment for executing a distributed learning system according to an embodiment of the present invention;

FIG. 2 is a high-level block diagram illustrating a typical computer system for implementing a distributed learning server and presenter and audience member computer systems;

FIG. 3 is a block diagram illustrating the functional units of the distributed learning server according to an embodiment of the present invention;

FIG. 4 illustrates a representative display according to an embodiment of the present invention for allowing a presenter to select a source of data;

FIG. 5 illustrates a representative display according to an embodiment of the present invention for allowing a presenter to view the selected sources of data;

FIG. 6 illustrates an exemplary screen display on the presenter computer system; and

FIG. 7 illustrates an exemplary screen display on the audience member computer system.

DETAILED DESCRIPTION OF THE PREFERRED EMBODIMENT

FIG. 1 is a block diagram illustrating a typical hardware environment for executing a distributed learning system **100** according to an embodiment of the present invention. One or more distributed learning servers (DLS) **102A–B** are coupled to a network **104** in addition to one or more presenter computer systems **106A–B**. Although only two DLS **102A–B** are shown in FIG. 1, it should be understood that there can be any practical number of DLS working either separately or in tandem to provide the functionality

described herein. Likewise, although only two presenter computer systems **106A–B** are illustrated in FIG. 1, it should be understood that there can be any practical number of presenters and associated presenter computer systems **106**. Similarly, four audience member computer systems **108A–D** are shown coupled to the network **104**, although there can also be any practical number of audience members and associated audience member computer systems **108**. The audience members and presenters are collectively referred to as the “participants.”

The network **104** is preferably the Internet. However, any local or wide area network may be used to support the distributed learning system as **100** described herein. In addition, the network **104** may be a dedicated subset of the Internet having specialized hardware allowing high-speed uni- or bi-directional communication.

FIG. 2 is a high-level block diagram illustrating a typical computer system **200** for implementing the DLS **102**, presenter **106**, and audience member **108** computer systems. FIG. 2 illustrates a processor **202** coupled to a bus **204**. Also coupled to the bus **204** are a memory **206**, a storage device **208**, a keyboard **210**, a graphics adapter **212**, a pointing device **214**, and a network adapter **216**. A display **218** is coupled to the graphics adapter **212**. The processor **202** may be any general-purpose processor such as an INTEL® x86 compatible or SUN MICROSYSTEMS SPARC® central processing unit (CPU). The storage device **208** may be any device capable of holding large amounts of data, like a hard drive, compact disk read-only memory (CD-ROM), DVD, or some form of removable storage device. The memory **206** holds instructions and data used by the processor **202**. The pointing device **214** may be a mouse, track ball, light pen, touch-sensitive display, or other type of pointing device and is used in combination with the keyboard **210** to input data into the computer system **200**. The graphics adapter **212** displays images and other information on the display **218**. The network adapter **216** couples the computer system **200** to the network **104** and may be, for example, a token-ring, Ethernet, or digital subscriber line adapter or a cable or high-speed analog modem.

As understood in the art, the functionality of the DLS **102**, presenter **106**, and audience member **108** computer systems described below may be performed by software or hardware modules within the computer systems. The modules according to one embodiment are software programs stored on the storage device **208**, loaded into the memory **206**, and executed by the processor **202**. Moreover, the presenter **106** and audience member **108** computer systems are distinguished primarily by use. The computer systems may be substantially identical and be used for different roles at different times.

The DLS **102** acts as the server for the distributed learning system **100** and relays information transmitted among the presenter **106** and audience member **108** computer systems. As illustrated in FIG. 1, multiple DLS **102** may be coupled to the network **104**. In one embodiment, the DLS **102** work together to provide distributed learning to multiple participants engaged in a single distributed learning session. In this embodiment, the processing load may be shared among the DLS **102** through the use of a load-balancing algorithm or similar technique. In another embodiment, the DLS **102** support multiple simultaneous distributed learning sessions. In this embodiment, each DLS **102A–B** may support a single distributed learning session or a plurality of concurrent distributed learning sessions.

The presenter computer system **106** is used by the presenter to communicate with the audience members and

6,155,840

5

control information that appears on the audience member computer systems **108**. A video camera **110** is preferably coupled to the presenter computer system **106** and provides a real time streaming digital video feed from the presenter to the DLS **102**. Another input device reproducing a digital feed may be coupled to the presenter computer system **106** in addition to or in place of the video camera, including, for example, an oscilloscope, an electron scanning microscope, a microphone, or any other device providing a live or pre-recorded output that can be converted to digital data.

Similarly, an audience member uses the audience member computer system **108** to receive the presentation from the presenter and communicate with the presenter and other audience members. The audience member computer systems **108** may be organized as a local area network **112** sharing a common link to the network **104**. In FIG. 1, for example, audience member computer systems **108C** and **108D** are linked in a local area network **112**. This configuration may be used, for example, when a classroom of linked computers is assembled at a location remote from the presenter. In addition, a video camera **110C** or input device may also be coupled to a student computer system **108B**.

Zero or more remote feeds **112** are also coupled to the network **104**. As used herein, the term "remote" means that the device or feed is not connected to the network **104** through a presenter **106** or audience member **108** computer system. A remote feed **112** may be a video camera providing a digital feed similar the camera **110** coupled to the presenter computer system **106** or the remote feed **112** may be some other form of live or pre-recorded streaming data. The remote feed **112** may be coupled to the network **104** through another computer system or through some other form of addressable network interface **104**.

FIG. 3 is a block diagram illustrating the functional units of the DLS **102**, including a distributed learning control module (DLCM) **310**, a classroom environment module **312**, and a streaming data module **314**. The DLCM **310** controls the communications among the various computer systems **106**, **108** in the distributed learning system **100** and manages the other modules in the DLS **102**. A preferred embodiment of the DLCM **310** executes an operating system like MICROSOFT WINDOWS NT® or SUN MICROSYSTEMS SOLARIS® 2.x and uses a hypertext transport protocol (HTTP)-based web server, like NETSCAPE ENTERPRISE SERVER 2.0 or the APACHE web server, to receive and respond to requests for data from the other computer systems **106**, **108**.

In addition, the DLCM **310** preferably includes software written in JAVASCRIPT and C++ providing auto-sensing capabilities for verifying that the participants' computer systems **106**, **108** meet the hardware and software requirements for participating in the distributed learning session. For example, the auto-sensing capabilities determine whether the participants' computer systems **106**, **108** support the correct display settings, browser and JAVA versions, and needed bandwidth. Moreover, the DLCM **310** software preferably provides the participants' computer systems **106**, **108** with the instructions for creating the properly-sized program windows and controls the content displayed therein. The DLCM **310** also includes authentication services for providing security to the participants and provides a presenter with streaming media selection functionality to enable configuring streaming media networks in an ad hoc fashion. The capabilities and controls supplied by the DLCM **310** are described in more detail below.

The classroom environment module **312** provides a classroom- or auditorium-like metaphor to the presenter and

6

audience members coupled to the DLS **102**, and a preferred embodiment of the classroom environment module **312** uses the PLACEWARE™ software product manufactured by PlaceWare, Inc., Mountain View, Calif. As used herein, the term "classroom" refers to an at least partially virtual space in which participants can interact. For example, in one embodiment the classroom environment module **312** provides a virtual room having a "podium" and "rows of seats." One or more presenters typically "stand" at the podium while the audience members "sit" in the seats. The classroom environment module **312** provides the presenter and audience member computer systems with a map of the virtual classroom, and identifies the locations of the presenters and audience members on the map. The audience members communicate with each other and the presenter by either changing the color of their seat on the map, or by passing messages to selected people in the room. In addition, the classroom environment module **312** provides advanced audience member feedback, including the ability to take instant polls of the audience members and graphically display the results to the presenters and audience members.

Moreover, the classroom environment module **312** provides the presenters with control over the information that appears on the audience members' computer systems. For example, a presenter may provide a MICROSOFT POWERPOINT® slide presentation to the audience members. Similarly, the presenter may cause the audience members to view a particular Internet web page. In addition, the presenter may draw over the displayed material and have the drawings appear on the audience members' computer systems in real time. This control is described in more detail below.

In addition to the control provided by the classroom environment module **312**, the streaming data module **314** provides one or more streaming data feeds to the presenter **106** and audience member **108** computer systems. As used herein, "streaming" refers to serial or parallel transmission of digital data between two computers by transmitting sequences of live or pre-recorded bit packets. A preferred embodiment of the streaming data module **314** uses the GTS Audio and Video Servers from Graham Technology Solutions, Inc., Cupertino, Calif. The streaming data module **314** receives streaming data, including video and audio data, from a computer system **106**, **108** or remote feed **112** coupled to the network **104** and provides it to the other computer systems **106**, **108**.

In one embodiment, the DLS **102** provides the presenter with administration tools allowing the presenter to configure a presentation. For example, the web pages allow the presenter to provide presentation materials that a participant can print out or review ahead of the scheduled session, a title for the presentation, information such as the phone number for the audio portion of the presentation, and any other information necessary to schedule and conduct the presentation. Preferably, a security module **316** within the DLCM **310** authenticates the presenter through the use of a login/password pair or some other technique to ensure that the presenter has sufficient security clearance to perform these actions.

In a preferred embodiment of the present invention, the administration pages of the DLS **102** also allow the presenter to pre-select the sources of data that will be used in the presentation. For example, the presenter may wish to pre-select a camera **110** coupled to the presenter's computer system **106** as a video source for the presentation. Alternatively, the presenter may wish to pre-select a source of data from one or more remote live or pre-recorded feeds **112**.

FIG. 4 illustrates a representative display 400 displayed on the presenter computer system 106 under direction of the DLCM 310 according to an embodiment of the present invention for allowing a presenter to define and select a source of data. The display 400 includes an "address" field 410 for allowing the presenter to submit the address on the network 104 of the source of data. In a preferred embodiment, the address is in the form of an Internet Protocol address or Domain Name System (DNS) name specifying a location of the source of data on the Internet. In an alternative embodiment, the address may be a numeric, nickname or shortened address whose meaning is understood by the DLS 100 to refer to a particular source of data. The display 400 also includes a "channel" field 414 allowing the presenter to select a channel of a multichannel source of data. Once the presenter has properly identified the source of data, the presenter selects the "add this node" button 414 to post the data to the DLS 102. Then, the presenter may select the "back" link 416 to return to the other administration tools.

FIG. 5 illustrates a representative display 500 displayed on the presenter computer system 106 under direction of the DLCM 310 according to an embodiment of the present invention for allowing a presenter to view the selected sources of data. The display 500 includes a list box 510 listing the sources of data that were previously selected via the display 400 illustrated in FIG. 4. A media window 512 displays the current feed received from the source of data selected in the list box 510. In the representative display 500 of FIG. 5, the source of data having the address "24.4.90.144" is selected in the list box 510 and the data from that source, a video stream, is displayed in the media window 512. By using this display 500, the presenter can preview the pre-selected sources of data before starting the presentation.

FIG. 6 illustrates an exemplary display 600 on the presenter 106 computer system and FIG. 7 illustrates an exemplary display 700 on an audience member 108 computer system. Both the presenter 106 and audience member computer systems preferably execute a JAVA®-enabled web browser or operating system, like NETSCAPE COMMUNICATOR®, MICROSOFT INTERNET EXPLORER®, or MICROSOFT WINDOWS 98. In each computer system 106, 108, the browser or operating system connects to the DLS 102, receives data in the form of hypertext markup language (HTML) instructions and JAVA code, and creates the illustrated display. The illustrated display represents a preferred embodiment of the present invention, although variations in the placement and function of displayed elements are possible.

In a preferred embodiment of the present invention, the display 600 on the presenter computer system has a fixed height and width, which in one embodiment is 1024x768 pixels. Fixing the size of the presenter display 600 assures that presenters have a reliable, stable, and consistent user interface, which results in improved ease of use for the presenter. The display 600 is preferably divided into separate regions of fixed size by browser frames, window borders, or another graphical border demarcation.

The content selection region 610 of the presenter is preferably located at the upper-left area of the display 600. The presenter uses this region 610 to control the content visible at the presenter 106 and audience member 108 computer systems in the first streaming media region 612. Within the content selection region 610 are a content selection list box 618, a classroom control window 620, and a classroom information window 622. The content selection list box 618 contains a list of possible sources for the first

media region 612. For example, the list box 618 may contain a list of video feeds pre-selected using the administration tools as described above with respect to FIGS. 4 and 5, web sites, or slides available to the presenter. When a particular item is selected from the content selection list box 618, the content is displayed in the first media region 612, 712 of the presenter 106 and audience member 108 computer systems.

The classroom information window 622 provides information about the presentation currently in progress. For example, in a preferred embodiment of the present invention, the audio portion of the presentation is carried over a telephone network separate from the network 104 carrying the other data. In this embodiment, the window 622 may provide a telephone number that a participant can call to hear the audio portion of the presentation. In an alternative embodiment where audio is transmitted over the network 104, the window may provide a telephone number that a participant can call should that participant's computer system lack audio capabilities or the window may provide other information.

The first media region 612 is preferably located at the upper-right area of the display and preferably contains the first media window 624 and the first media window controls 626. The first media window 624 displays the content selected in the content selection list box 618. As mentioned above, the displayed content may include a video feed, a slide show, a web page, a white board with real-time updates, or some other form of graphical information. In the embodiment where the displayed content is generated at the presenter's computer system 106, the content is preferably displayed in the window 624 as it is sent to the DLS 102 for distribution to the other computer systems coupled to the network 104. In the embodiment where the displayed content is received from outside the presenter's computer system 106, like when the content is a web page or a video feed from a remote location, the content is preferably displayed in the window 624 as it is received from the DLS 102.

The first media window controls 626 provide tools for controlling and modifying the content of the first media window 624. In one embodiment, the controls 626 provide pointer and drawing tools that the presenter uses to identify or mark portions of the displayed content. For example, the presenter can use the streaming media window controls 626 to draw on a displayed slide. The drawing is communicated to the audience member computer systems 108 and displayed in real time.

The second media region 614 is preferably located at the lower-left area of the display 600 and preferably contains the second media window 628 and the second media window content list box 630. The second media window 628 preferably displays the same types of content as the first media window 624. Since the second streaming media window 628 is smaller than the first 624, the second window 628 is more suitable for live video and other streaming feeds that might exceed the available bandwidth of the network 104 if supporting the data rate of the first media window 624. The second media window content list box 630 preferably displays the sources of data pre-selected by the presenter and controls the source of the content displayed in the second media window 628.

The feedback region 616 is preferably located at the lower-right area of the display 600 and allows the presenter to receive feedback from the audience members. Within the feedback region 616 are the presentation text window 632 and the audience member response window 634. The presentation text window 632 allows the presenter to pass text

messages to the other computer systems. In one embodiment of the present invention, the presenter enters the text message into a text field and then enters a "post" command that passes the message to the other computer systems.

The audience member response window **634** preferably provides a seating chart showing the audience members and presenters in the classroom or auditorium. In one embodiment of the present invention, the seating chart provides a colored box for each participant. Participants can communicate messages like "I'm here," "I need help," and "go faster" to the presenter by changing the color of the box. A key preferably displayed adjacent to the seating chart explains the meaning of each color.

Turning to FIG. 7, in a preferred embodiment of the present invention, the audience member display **700** is fixed at 800x600 pixels and is chromeless, i.e. lacks certain window and menu bar controls. The display **700** is divided into separate regions of fixed size by using browser frames or another graphical demarcation of the region borders. The upper left area of the display **700** is the presentation/feedback region **710**. The upper right area is the first streaming media region **712** and the lower portion is the second streaming media region **714**.

The audience member uses the presentation/feedback region **710** to view presentation text provided by the presenter, provide feedback to the presenter, and communicate with other audience members. In presentation mode, the region **710** has a presentation text window **716** that displays the text transmitted by the presenter via the presenter presentation text window **632**. The region also has a classroom information window **718** that displays the information about the presentation currently in progress entered by the presenter in window **622**. Similarly, the region also has a presentation information window **720** that displays the title of the presentation, name of the presenter, or other information selected by the presenter.

A "user guide" button **722** allows the audience member to display a second window having content dynamically controlled by the presenter. For example, the user guide button **722**, when activated during the beginning of the presentation, could display a problem set provided by the presenter. When activated later in the presentation, the user guide button might display the answers to the problem set. Similarly, the presenter can configure the user guide button to provide additional information not provided in the presentation or any other information which the presenter wishes to provide to the audience members. An "exit console" button **723** allows the audience member to exit from the current presentation and close the window.

In feedback mode, the region **710** displays tools allowing the audience member to provide feedback to presenters. For example, the region **710** may display radio buttons allowing the audience member to rate his or her satisfaction with the current presentation. This feedback is reflected in the presenter's feedback region **616**. In communication mode, the region **710** preferably displays a list of participants with whom the audience member may conduct a chat session and a text window displaying communicated text. In one embodiment, the list displays the names of participants sitting in the same row as the audience member.

The first media region **712** contains the first media window **724**, which displays the contents selected by the presenter via the content selection window **618**. Similarly, the second media window **726** in the second media region **714** displays the contents selected by the presenter via the second media window content list box **630**. Audio controls **728**

adjacent to the second streaming media window allow the audience member to control the playing of the audio portion of the presentation.

An "evaluation" button **730** preferably causes an evaluation window to open. The audience member uses the evaluation window to provide feedback to the presenter on the usefulness of the presentation. In addition, a "home" button **732** preferably allows the audience member to leave the current presentation. In one embodiment, an audience member who presses the home button **732** is returned to a "conference center" from where the audience member can select another presentation.

The described distributed learning system **100** enhances the distributed learning experience because it allows remotely located presenters and audience members to engage in a traditional classroom discussion. Skills and behaviors learned by the participants in other learning environments, including real classrooms, are immediately applicable to the environment provided by the system. Since the provided tools are standardized and relatively easy to use, the participants can concentrate on the instruction rather than the technology. Moreover, since the provided tools are readily available and remove the obstacles of cost and inconvenience of convening audience members, presenters, and relevant experts, leaning sessions can more readily occur just as they are needed.

What is claimed is:

1. A method of conducting distributed learning among a plurality of computer systems coupled to a network, the method comprising the steps of:

providing instructions to a first computer system coupled to the network for:

creating a graphical display representative of a classroom;

creating a graphical display illustrating controls for selecting first and second data streams;

creating a first window for displaying the first selected data stream; and

creating a second window for displaying the second selected data stream, wherein

the first and second windows are displayed simultaneously; and

providing instructions to a second computer system coupled to the network for:

creating a graphical display representative of the classroom;

creating a third window for displaying the first selected data stream; and

creating a fourth window for displaying the second selected data stream, wherein

the third and fourth windows are displayed simultaneously.

2. The method of claim 1, wherein the step of creating a second window for displaying the second selected data stream creates a smaller window using a lower data rate than the window for displaying the first selected data stream.

3. The method of claim 1, further comprising the step of: providing instructions to the first computer system coupled to the network for:

creating a graphical display illustrating controls for locating a plurality of data streams;

wherein the graphical display illustrating controls for selecting the first data stream illustrates controls for selecting among the located plurality of data streams.

4. The method of claim 3, wherein the step of creating a graphical display illustrating controls for locating a plurality of data streams comprises the step of:

6,155,840

11

creating a graphical display illustrating controls for locating a plurality of data streams originating remotely from the first and second computer systems.

5 5. The method of claim 1, wherein the step of creating a graphical display illustrating controls for selecting a first data stream comprises the step of:

creating a graphical display illustrating controls for selecting a data stream representative of video data;

10 wherein the windows on the first and second computer systems for displaying the first selected data stream display the video data.

6. The method of claim 1, wherein computer instructions for performing the method steps are encoded on a computer-readable medium.

7. The method of claim 1, wherein the step of providing instructions to a second computer system coupled to the network further comprises the steps of:

creating a fixed size browser window for displaying the graphical display representative of the classroom;

creating a fixed size browser window for displaying the first selected data stream; and

25 creating a fixed size browser window for displaying the second selected data stream.

8. A system for conducting distributed learning among a plurality of computer systems coupled to a network, the system comprising:

a presenter computer system of the plurality of computer systems coupled to the network and comprising:

a content selection control for defining at least one remote streaming data source and for selecting one of the remote streaming data sources for viewing; and

30 a presenter streaming data viewer for displaying data produced by the selected remote streaming data source;

an audience member computer system of the plurality of computer systems and coupled to the presenter computer system via the network, the audience member computer system comprising:

an audience member streaming data viewer for displaying the data produced by the selected remote streaming data source; and

45 a distributed learning server remote from the presenter and audience member computer systems of the plurality of computer systems and coupled to the presenter computer system and the audience member computer system via the network and comprising:

a streaming data module for providing the streaming data from the remote streaming data source selected with the content selection control to the presenter and audience member computer systems; and

50 a distributed learning control module for receiving communications transmitted between the presenter and the audience member computer systems and for relaying the communications to an intended receiving computer system and for coordinating the operation of the streaming data module.

9. The system of claim 8, wherein the distributed learning server further comprises:

65 a classroom environment module for providing a representation of a classroom to the presenter and audience member computer systems.

12

10. The system of claim 9, wherein the presenter computer system and the audience member computer system each further comprises:

a graphical representation of a classroom.

11. The system of claim 10, wherein the graphical representation of a classroom further includes a plurality of icons representative of audience members, wherein the color of each icon indicates a particular audience member response.

12. The distributed learning server of claim 11, wherein the module for providing a second graphical display on the audience member computer system comprises a Java-compatible Web browser.

13. The system of claim 8, wherein at least one of the defined remote streaming data sources provides data representative of a video signal.

14. The system of claim 13, wherein the presenter streaming data viewer and the audience member streaming data viewer display data produced by a new selected remote streaming data source responsive to, and substantially simultaneously with, the selecting of the new remote streaming data source with the content selection control.

15 15. The system of claim 8, wherein the distributed learning server further comprises a module for verifying that the audience member computer system meets hardware and software requirements for displaying the data produced by the selected remote streaming data source.

16. The system of claim 8, wherein the distributed learning server simultaneously hosts a plurality of separate distributed learning sessions.

17. A distributed learning server for controlling a presenter computer system and an audience member computer system coupled to the distributed learning server via a network, the distributed learning server comprising:

a module for providing a first graphical display on the presenter computer system, the first graphical display comprising:

a first presenter content selection control for selecting a first source of streaming content representative of graphical information;

a first presenter content display region for displaying the graphical information represented by the streaming content from the first selected source;

a second presenter content selection control for selecting a second source of streaming content representative of graphical information; and

45 a second presenter content display region for displaying the graphical information represented by the streaming content from the second selected source, wherein the first and second presenter content display regions are adapted to display simultaneously; and

a classroom region for representing the audience member computer system coupled to the distributed learning server; and

50 a module for providing a second graphical display on the audience member computer system, the second graphical display comprising:

a first audience member content display region for displaying the graphical information represented by the streaming content from the first source selected by the content selection control; and

60 a second audience member content display region for displaying the graphical information represented by the streaming content from the second source selected by the content selection control, wherein the first and second audience member content display regions are adapted to display simultaneously.

18. The distributed learning server of claim 17, wherein the first graphical display further comprises:

13

a control for defining a plurality of sources of streaming content representative of graphical information; wherein the first presenter content selection control allows selection of one of the defined plurality of sources of streaming content.

19. The distributed learning server of claim 17, wherein the second presenter content display region has a smaller window size and a lower data rate than the first presenter content display region.

20. The distributed learning server of claim 17, wherein a source of streaming content available for selection by the content selection control is a video camera coupled to the presenter computer system.

21. The distributed learning server of claim 17, wherein a source of streaming content available for selection by the

14

content selection control is remote from the presenter computer system and the audience member computer system.

22. The distributed learning server of claim 17, further comprising:

5 a module for authenticating a user of the presenter computer system to prevent unauthorized use of the content selection control.

23. The distributed learning server of claim 17, wherein the source of streaming content representative of graphical information is pre-recorded.

10 24. The distributed learning server of claim 17, wherein the module for providing a first graphical display on the presenter computer system comprises a Java-compatible Web browser.

* * * * *

**UNITED STATES DISTRICT COURT
CENTRAL DISTRICT OF CALIFORNIA**

NOTICE OF ASSIGNMENT TO UNITED STATES MAGISTRATE JUDGE FOR DISCOVERY

This case has been assigned to District Judge John Kronstadt and the assigned discovery Magistrate Judge is Charles Eick.

The case number on all documents filed with the Court should read as follows:

CV12- 4335 JAK (Ex)

Pursuant to General Order 05-07 of the United States District Court for the Central District of California, the Magistrate Judge has been designated to hear discovery related motions.

All discovery related motions should be noticed on the calendar of the Magistrate Judge

NOTICE TO COUNSEL

A copy of this notice must be served with the summons and complaint on all defendants (if a removal action is filed, a copy of this notice must be served on all plaintiffs).

Subsequent documents must be filed at the following location:

Western Division
312 N. Spring St., Rm. G-8
Los Angeles, CA 90012

Southern Division
411 West Fourth St., Rm. 1-053
Santa Ana, CA 92701-4516

Eastern Division
3470 Twelfth St., Rm. 134
Riverside, CA 92501

Failure to file at the proper location will result in your documents being returned to you.

BRETT J. WILLIAMSON (S.B. #14235)
GEOFFREY H. YOST (S.B. #159687)
O'MELVENY & MYERS LLP
610 Newport Center Drive, 17th Floor
Newport Beach, CA 92660

**UNITED STATES DISTRICT COURT
CENTRAL DISTRICT OF CALIFORNIA**

RICHARD A. WILLIAMSON, ON BEHALF OF
AND AS TRUSTEE FOR AT HOME
BONDHOLDERS' LIQUIDATING TRUST
PLAINTIFF(S)

CASE NUMBER

CV12-04335-JAK(Ex)

v.

BLACKBOARD INC.; ELLUMINATE USA, INC.;
and WIMBA, INC.

DEFENDANT(S).

SUMMONS

TO: DEFENDANT(S):

A lawsuit has been filed against you.

Within 21 days after service of this summons on you (not counting the day you received it), you must serve on the plaintiff an answer to the attached complaint _____ amended complaint counterclaim cross-claim or a motion under Rule 12 of the Federal Rules of Civil Procedure. The answer or motion must be served on the plaintiff's attorney, Brett J. Williamson, whose address is 610 Newport Center Drive, 17th Floor, Newport Beach, CA 92660. If you fail to do so, judgment by default will be entered against you for the relief demanded in the complaint. You also must file your answer or motion with the court.

Clerk, U.S. District Court

Dated: 5/18/2012

By: 
Deputy Clerk

(Seal of the Court)

[Use 60 days if the defendant is the United States or a United States agency, or is an officer or employee of the United States. Allowed 60 days by Rule 12(a)(3)].

| | |
|--|--|
| I (a) PLAINTIFFS (Check box if you are representing yourself <input type="checkbox"/> RICHARD A. WILLIAMSON, ON BEHALF OF AND AS TRUSTEE FOR AT HOME BONDHOLDERS' LIQUIDATING TRUST | DEFENDANTS BLACKBOARD INC.; ELLUMINATE USA, INC.; and WIMBA, INC. |
| (b) Attorneys (Firm Name, Address and Telephone Number. If you are representing yourself, provide same.) BRETT J. WILLIAMSON (S.B. #145235), GEOFFREY H. YOST (S.B. #159687); O'MELVENY & MYERS LLP; 610 Newport Center Drive, 17th Floor; Newport Beach, CA 92660; (949) 823-6900 | Attorneys (If Known) MICHAEL S. NADEL; McDermott Will & Emery LLP; 600 Thirteenth Street, N.W.; Washington, D.C. 20005; (202) 756-8113; FAY E. MORISSEAU, DANIEL R. FOSTER, CHRISTOPHER D. BRIGHT; McDermott Will & Emery LLP; 4 Park Plaza, Suite 1700; Irvine, CA 92614; (949) 851-0633 |

| | | | | | | | | | | | | | | | | | | | | | | | | | |
|--|---|----------------------------|---|----------------------------|----------------------------|------------|------------|-----------------------|----------------------------|----------------------------|---|----------------------------|----------------------------|--------------------------|----------------------------|----------------------------|---|----------------------------|----------------------------|---|----------------------------|----------------------------|----------------|----------------------------|----------------------------|
| II. BASIS OF JURISDICTION (Place an X in one box only.) <input type="checkbox"/> 1 U.S. Government Plaintiff <input checked="" type="checkbox"/> 3 Federal Question (U.S. Government Not a Party) <input type="checkbox"/> 2 U.S. Government Defendant <input type="checkbox"/> 4 Diversity (Indicate Citizenship of Parties in Item III) | III. CITIZENSHIP OF PRINCIPAL PARTIES - For Diversity Cases Only (Place an X in one box for plaintiff and one for defendant.) <table style="width:100%; border-collapse: collapse;"> <tr> <td style="width:30%;"></td> <td style="width:10%; text-align: center;">PTF</td> <td style="width:10%; text-align: center;">DEF</td> <td style="width:40%;"></td> <td style="width:10%; text-align: center;">PTF</td> <td style="width:10%; text-align: center;">DEF</td> </tr> <tr> <td>Citizen of This State</td> <td style="text-align: center;"><input type="checkbox"/> 1</td> <td style="text-align: center;"><input type="checkbox"/> 1</td> <td>Incorporated or Principal Place of Business in this State</td> <td style="text-align: center;"><input type="checkbox"/> 4</td> <td style="text-align: center;"><input type="checkbox"/> 4</td> </tr> <tr> <td>Citizen of Another State</td> <td style="text-align: center;"><input type="checkbox"/> 2</td> <td style="text-align: center;"><input type="checkbox"/> 2</td> <td>Incorporated and Principal Place of Business in Another State</td> <td style="text-align: center;"><input type="checkbox"/> 5</td> <td style="text-align: center;"><input type="checkbox"/> 5</td> </tr> <tr> <td>Citizen or Subject of a Foreign Country</td> <td style="text-align: center;"><input type="checkbox"/> 3</td> <td style="text-align: center;"><input type="checkbox"/> 3</td> <td>Foreign Nation</td> <td style="text-align: center;"><input type="checkbox"/> 6</td> <td style="text-align: center;"><input type="checkbox"/> 6</td> </tr> </table> | | PTF | DEF | | PTF | DEF | Citizen of This State | <input type="checkbox"/> 1 | <input type="checkbox"/> 1 | Incorporated or Principal Place of Business in this State | <input type="checkbox"/> 4 | <input type="checkbox"/> 4 | Citizen of Another State | <input type="checkbox"/> 2 | <input type="checkbox"/> 2 | Incorporated and Principal Place of Business in Another State | <input type="checkbox"/> 5 | <input type="checkbox"/> 5 | Citizen or Subject of a Foreign Country | <input type="checkbox"/> 3 | <input type="checkbox"/> 3 | Foreign Nation | <input type="checkbox"/> 6 | <input type="checkbox"/> 6 |
| | PTF | DEF | | PTF | DEF | | | | | | | | | | | | | | | | | | | | |
| Citizen of This State | <input type="checkbox"/> 1 | <input type="checkbox"/> 1 | Incorporated or Principal Place of Business in this State | <input type="checkbox"/> 4 | <input type="checkbox"/> 4 | | | | | | | | | | | | | | | | | | | | |
| Citizen of Another State | <input type="checkbox"/> 2 | <input type="checkbox"/> 2 | Incorporated and Principal Place of Business in Another State | <input type="checkbox"/> 5 | <input type="checkbox"/> 5 | | | | | | | | | | | | | | | | | | | | |
| Citizen or Subject of a Foreign Country | <input type="checkbox"/> 3 | <input type="checkbox"/> 3 | Foreign Nation | <input type="checkbox"/> 6 | <input type="checkbox"/> 6 | | | | | | | | | | | | | | | | | | | | |

IV. ORIGIN (Place an X in one box only.)

1 Original Proceeding
 2 Removed from State Court
 3 Remanded from Appellate Court
 4 Reinstated or Reopened
 5 Transferred from another district (specify): _____
 6 Multi-District Litigation
 7 Appeal to District Judge from Magistrate Judge

V. REQUESTED IN COMPLAINT: **JURY DEMAND:** Yes No (Check 'Yes' only if demanded in complaint.)

CLASS ACTION under F.R.C.P. 23: Yes No **MONEY DEMANDED IN COMPLAINT: \$** _____

VI. CAUSE OF ACTION (Cite the U.S. Civil Statute under which you are filing and write a brief statement of cause. Do not cite jurisdictional statutes unless diversity.)
 Patent Infringement under 35 U.S.C. Section 271

VII. NATURE OF SUIT (Place an X in one box only.)

| | | | | | |
|---|--|--|---|---|--|
| OTHER STATUTES <input type="checkbox"/> 400 State Reapportionment <input type="checkbox"/> 410 Antitrust <input type="checkbox"/> 430 Banks and Banking <input type="checkbox"/> 450 Commerce/ICC Rates/etc. <input type="checkbox"/> 460 Deportation <input type="checkbox"/> 470 Racketeer Influenced and Corrupt Organizations <input type="checkbox"/> 480 Consumer Credit <input type="checkbox"/> 490 Cable/Sat TV <input type="checkbox"/> 810 Selective Service <input type="checkbox"/> 850 Securities/Commodities/Exchange <input type="checkbox"/> 875 Customer Challenge 12 USC 3410 <input type="checkbox"/> 890 Other Statutory Actions <input type="checkbox"/> 891 Agricultural Act <input type="checkbox"/> 892 Economic Stabilization Act <input type="checkbox"/> 893 Environmental Matters <input type="checkbox"/> 894 Energy Allocation Act <input type="checkbox"/> 895 Freedom of Info. Act <input type="checkbox"/> 900 Appeal of Fee Determination Under Equal Access to Justice <input type="checkbox"/> 950 Constitutionality of State Statutes | CONTRACT <input type="checkbox"/> 110 Insurance <input type="checkbox"/> 120 Marine <input type="checkbox"/> 130 Miller Act <input type="checkbox"/> 140 Negotiable Instrument <input type="checkbox"/> 150 Recovery of Overpayment & Enforcement of Judgment <input type="checkbox"/> 151 Medicare Act <input type="checkbox"/> 152 Recovery of Defaulted Student Loan (Excl. Veterans) <input type="checkbox"/> 153 Recovery of Overpayment of Veteran's Benefits <input type="checkbox"/> 160 Stockholders' Suits <input type="checkbox"/> 190 Other Contract <input type="checkbox"/> 195 Contract Product Liability <input type="checkbox"/> 196 Franchise REAL PROPERTY <input type="checkbox"/> 210 Land Condemnation <input type="checkbox"/> 220 Foreclosure <input type="checkbox"/> 230 Rent Lease & Ejectment <input type="checkbox"/> 240 Torts to Land <input type="checkbox"/> 245 Tort Product Liability <input type="checkbox"/> 290 All Other Real Property | TORTS PERSONAL INJURY <input type="checkbox"/> 310 Airplane <input type="checkbox"/> 315 Airplane Product Liability <input type="checkbox"/> 320 Assault, Libel & Slander <input type="checkbox"/> 330 Fed. Employers' Liability <input type="checkbox"/> 340 Marine <input type="checkbox"/> 345 Marine Product Liability <input type="checkbox"/> 350 Motor Vehicle <input type="checkbox"/> 355 Motor Vehicle Product Liability <input type="checkbox"/> 360 Other Personal Injury <input type="checkbox"/> 362 Personal Injury-Med Malpractice <input type="checkbox"/> 365 Personal Injury-Product Liability <input type="checkbox"/> 368 Asbestos Personal Injury Product Liability IMMIGRATION <input type="checkbox"/> 462 Naturalization Application <input type="checkbox"/> 463 Habeas Corpus-Alien Detainee <input type="checkbox"/> 465 Other Immigration Actions | TORTS PERSONAL PROPERTY <input type="checkbox"/> 370 Other Fraud <input type="checkbox"/> 371 Truth in Lending <input type="checkbox"/> 380 Other Personal Property Damage <input type="checkbox"/> 385 Property Damage Product Liability BANKRUPTCY <input type="checkbox"/> 422 Appeal 28 USC 158 <input type="checkbox"/> 423 Withdrawal 28 USC 157 CIVIL RIGHTS <input type="checkbox"/> 441 Voting <input type="checkbox"/> 442 Employment <input type="checkbox"/> 443 Housing/Accommodations <input type="checkbox"/> 444 Welfare <input type="checkbox"/> 445 American with Disabilities - Employment <input type="checkbox"/> 446 American with Disabilities - Other <input type="checkbox"/> 440 Other Civil Rights | PRISONER PETITIONS <input type="checkbox"/> 510 Motions to Vacate Sentence Habeas Corpus <input type="checkbox"/> 530 General <input type="checkbox"/> 535 Death Penalty <input type="checkbox"/> 540 Mandamus/Other <input type="checkbox"/> 550 Civil Rights <input type="checkbox"/> 555 Prison Condition FORFEITURE / PENALTY <input type="checkbox"/> 610 Agriculture <input type="checkbox"/> 620 Other Food & Drug <input type="checkbox"/> 625 Drug Related Seizure of Property 21 USC 881 <input type="checkbox"/> 630 Liquor Laws <input type="checkbox"/> 640 R.R. & Truck <input type="checkbox"/> 650 Airline Regs <input type="checkbox"/> 660 Occupational Safety/Health <input type="checkbox"/> 690 Other | LABOR <input type="checkbox"/> 710 Fair Labor Standards Act <input type="checkbox"/> 720 Labor/Mgmt. Relations <input type="checkbox"/> 730 Labor/Mgmt. Reporting & Disclosure Act <input type="checkbox"/> 740 Railway Labor Act <input type="checkbox"/> 790 Other Labor Litigation <input type="checkbox"/> 791 Empl. Ret. Inc. Security Act PROPERTY RIGHTS <input type="checkbox"/> 820 Copyrights <input checked="" type="checkbox"/> 830 Patent <input type="checkbox"/> 840 Trademark SOCIAL SECURITY <input type="checkbox"/> 861 HIA (1395ff) <input type="checkbox"/> 862 Black Lung (923) <input type="checkbox"/> 863 DIWC/DIWW (405(g)) <input type="checkbox"/> 864 SSID Title XVI <input type="checkbox"/> 865 RSI (405(g)) FEDERAL TAX SUITS <input type="checkbox"/> 870 Taxes (U.S. Plaintiff or Defendant) <input type="checkbox"/> 871 IRS-Third Party 26 USC 7609 |
|---|--|--|---|---|--|

FOR OFFICE USE ONLY: Case Number: CV12-04335-JAK(Ex)

AFTER COMPLETING THE FRONT SIDE OF FORM CV-71, COMPLETE THE INFORMATION REQUESTED BELOW.

VIII(a). IDENTICAL CASES: Has this action been previously filed in this court and dismissed, remanded or closed? No Yes

If yes, list case number(s): _____

VIII(b). RELATED CASES: Have any cases been previously filed in this court that are related to the present case? No Yes

If yes, list case number(s): 2:11-cv-02409-AHM-JEM (C.D. Cal.)

Civil cases are deemed related if a previously filed case and the present case:

- (Check all boxes that apply) A. Arise from the same or closely related transactions, happenings, or events; or
 B. Call for determination of the same or substantially related or similar questions of law and fact; or
 C. For other reasons would entail substantial duplication of labor if heard by different judges; or
 D. Involve the same patent, trademark or copyright, and one of the factors identified above in a, b or c also is present.

IX. VENUE: (When completing the following information, use an additional sheet if necessary.)

(a) List the County in this District; California County outside of this District; State if other than California; or Foreign Country, in which EACH named plaintiff resides.
 Check here if the government, its agencies or employees is a named plaintiff. If this box is checked, go to item (b).

| | |
|---------------------------|---|
| County in this District * | California County outside of this District; State, if other than California; or Foreign Country |
| | New York County, NY |

(b) List the County in this District; California County outside of this District; State if other than California; or Foreign Country, in which EACH named defendant resides.
 Check here if the government, its agencies or employees is a named defendant. If this box is checked, go to item (c).

| | |
|---------------------------|--|
| County in this District:* | California County outside of this District; State, if other than California; or Foreign Country |
| | Illuminate USA, Inc. (Alameda, CA; D.C.); Wimba, Inc. (Manhattan, NY; D.C.); Blackboard, Inc. (D.C.) |

(c) List the County in this District; California County outside of this District; State if other than California; or Foreign Country, in which EACH claim arose.

Note: In land condemnation cases, use the location of the tract of land involved.

| | |
|---------------------------|---|
| County in this District:* | California County outside of this District; State, if other than California; or Foreign Country |
| Los Angeles | |

* Los Angeles, Orange, San Bernardino, Riverside, Ventura, Santa Barbara, or San Luis Obispo Counties

Note: In land condemnation cases, use the location of the tract of land involved

X. SIGNATURE OF ATTORNEY (OR PRO PER): _____

Date

5/18/12

Notice to Counsel/Parties: The CV-71 (JS-44) Civil Cover Sheet and the information contained herein neither replace nor supplement the filing and service of pleadings or other papers as required by law. This form, approved by the Judicial Conference of the United States in September 1974, is required pursuant to Local Rule 3-1 is not filed but is used by the Clerk of the Court for the purpose of statistics, venue and initiating the civil docket sheet. (For more detailed instructions, see separate instructions sheet.)

Key to Statistical codes relating to Social Security Cases:

| Nature of Suit Code | Abbreviation | Substantive Statement of Cause of Action |
|---------------------|--------------|--|
| 861 | HIA | All claims for health insurance benefits (Medicare) under Title 18, Part A, of the Social Security Act, as amended. Also, include claims by hospitals, skilled nursing facilities, etc., for certification as providers of services under the program. (42 U.S.C. 1935FF(b)) |
| 862 | BL | All claims for "Black Lung" benefits under Title 4, Part B, of the Federal Coal Mine Health and Safety Act of 1969. (30 U.S.C. 923) |
| 863 | DIWC | All claims filed by insured workers for disability insurance benefits under Title 2 of the Social Security Act, as amended; plus all claims filed for child's insurance benefits based on disability. (42 U.S.C. 405(g)) |
| 863 | DIWW | All claims filed for widows or widowers insurance benefits based on disability under Title 2 of the Social Security Act, as amended. (42 U.S.C. 405(g)) |
| 864 | SSID | All claims for supplemental security income payments based upon disability filed under Title 16 of the Social Security Act, as amended. |
| 865 | RSI | All claims for retirement (old age) and survivors benefits under Title 2 of the Social Security Act, as amended. (42 U.S.C. (g)) |