

1 John V. Picone III, Bar No. 187226
jpicone@hopkinscarley.com
2 Jennifer S. Coleman, Bar No. 213210
jcoleman@hopkinscarley.com
3 HOPKINS & CARLEY
A Law Corporation
4 The Letitia Building
70 South First Street
5 San Jose, CA 95113-2406

6 **mailing address:**
P.O. Box 1469
7 San Jose, CA 95109-1469
Telephone: (408) 286-9800
8 Facsimile: (408) 998-4790

9 Attorneys for Plaintiff
PI-NET INTERNATIONAL, INC.



11 UNITED STATES DISTRICT COURT
12 CENTRAL DISTRICT OF CALIFORNIA
13 WESTERN DIVISION

14 PI-NET INTERNATIONAL, INC.,

Case No. **CV12-09703** DDP(VBK)

15 Plaintiff,

**COMPLAINT FOR PATENT
INFRINGEMENT**

16 v.

17 CAL POLY FEDERAL CREDIT
UNION,

JURY TRIAL DEMANDED

18 Defendant.
19

20 Plaintiff Pi-Net International, Inc. hereby files this complaint for patent
21 infringement against Cal Poly Federal Credit Union, and alleges upon information
22 and belief as follows:

23 **PARTIES**

24 1. Plaintiff Pi-Net International, Inc. ("Pi-Net") is a California
25 corporation with its principal place of business at 222 Stanford Avenue, Menlo
26 Park, California 94025. Pi-Net has been a provider of innovative software

27 ///
28 ///

1 products, services and solutions that enable distributed transaction processing and
2 control over public and private networks, including, without limitation, the Internet
3 and the World-Wide Web.

4 2. The patents asserted here were issued to Dr. Lakshmi Arunachalam,
5 Pi-Net's founder. Having a priority date of 1995, the patents disclose the
6 fundamental technology underlying Web commerce and Web banking and financial
7 services by use of Web applications, which had exemplified the pioneering
8 technology by reference to the specific online financial services on the Web that are
9 reflected in the Defendant's accused systems.

10 3. Defendant Cal Poly Federal Credit Union ("CP-FCU") is a federally
11 chartered credit union that does business out of its registered office at 3801 W
12 Temple Ave. Bldg. 35, Pomona, CA 91768. CP-FCU maintains a principal place of
13 business at 3801 W Temple Ave. Bldg. 35, Pomona, CA 91768. CP-FCU is a
14 credit union, a financial institution that serves individual consumers, small-and
15 middle-market businesses with a range of banking, investing, asset management
16 and other financial and risk management products and services.

17 JURISDICTION AND VENUE

18 4. This is an action for patent infringement arising under the patent laws
19 of the United States, Title 35 of the United States Code. This Court has subject
20 matter jurisdiction pursuant to 28 U.S.C. §§ 1331 and 1338(a).

21 5. This Court has personal jurisdiction over the Defendants by virtue of
22 their presence and business activities within this judicial district.

23 6. Venue is proper in this judicial district pursuant to 28 U.S.C. §§
24 1391(b), 1391(c) and 1400(b).

25 BACKGROUND

26 7. On November 16, 1999, the United States Patent and Trademark
27 Office duly and legally issued U.S. Patent No. 5,987,500 ("the '500 Patent"),
28 entitled "Value- Added Network System For Enabling Real-Time, By-Directional

1 Transactions On A Network,” to Dr. Lakshmi Arunachalam. Pi-Net is the assignee
2 of all rights, title, and interest in the ‘500 Patent, including the right to recover
3 damages for past infringement. The ‘500 patent is valid and enforceable and a copy
4 of the Patent is attached to the Complaint as Exhibit A.

5 8. On October 11, 2011, the United States Patent and Trademark Office
6 duly and legally issued U.S. Patent No. 8,037,158 (“the ‘158 Patent”), entitled
7 “Multimedia Transactional Services,” to Dr. Lakshmi Arunachalam. Pi-Net is the
8 assignee of all rights, title, and interest in the ‘158 Patent, including the right to
9 recover damages for past infringement. The ‘158 patent is valid and enforceable
10 and a copy of the Patent is attached to the Complaint as Exhibit B.

11 9. On January 31, 2012, the United States Patent and Trademark Office
12 duly and legally issued U.S. Patent No. 8,108,492 (“the ‘492 Patent”), entitled
13 “Web Application Network Portal,” to Dr. Lakshmi Arunachalam. Pi-Net is the
14 assignee of all rights, title, and interest in the ‘492 Patent, including the right to
15 recover damages for past infringement. The ‘492 patent is valid and enforceable
16 and a copy of the Patent is attached to the Complaint as Exhibit C.

17 10. CP-FCU provides online Web banking services accessible at least
18 through its website including, but not limited to the website
19 <http://www.calpolyfcu.org/>, whose features are exemplified, in part, by the
20 following screenshot:

21 ///
22 ///
23 ///
24 ///
25 ///
26 ///
27 ///
28 ///

1
2
3
4
5
6
7
8
9
10
11
12
13
14
15
16
17
18
19
20
21
22
23
24
25
26
27
28

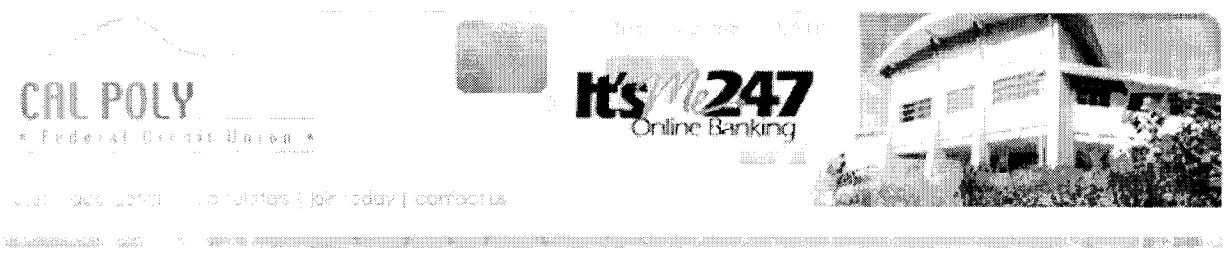

- About Us
- Savings & Checking
- Loans
- Rates
- Services
- Online Services
- Tools & Resources
- Switch BR
- Newsletter

Welcome to Cal Poly Federal Credit Union

Access your money 24/7 with It's Me 24/7 (click on the icon above). This portal gives you access to FREE Homebanking, Bill Pay, E-Statements, Mobile & Text Banking.

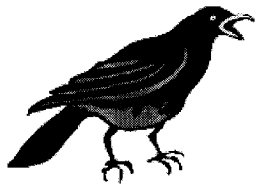

Apply Here!

Too Many Bills? Are you struggling to keep control of your bills? A Consolidation Loan can make life easier - it can consolidate your monthly bills into one manageable payment. Save yourself time, money, headaches, and stamps. Give Cathy a call at 909.869.6823.

Helpful Links

- AGI
- Bronco Bucks
- Bronco Direct
- Statements before September 2011
- Poly Centric



We're The Smart Option With college costs growing fast. It's time to borrow smarter. The Smart Option Student Loan with Sallie Mae offers three repayment options and competitive interest rates to help you pay for college expenses not covered by grants, scholarships and federal loans.

COUNT I

(Infringement of the '500 Patent)

11. Pi-Net incorporates and realleges paragraphs 1-12.

12. CP-FCU has directly infringed and is continuing to infringe one or more claims of the '500 Patent by conducting real-time, two-way Web transactions concerning Web banking, credit union and financial services Web transactions from Web banking applications, Web credit union applications, and Web financial services Web applications.

13. Defendants' infringement has injured Plaintiff. Accordingly, Plaintiff is entitled to recover damages adequate to compensate it for such infringement, but in no event less than a reasonable royalty, and an injunction to prohibit further infringement of the '500 Patent or future compensation for use of the inventions.

///

1
2
3
4
5
6
7
8
9
10
11
12
13
14
15
16
17
18
19
20
21
22
23
24
25
26
27
28

PRAYER FOR RELIEF

WHEREFORE, Plaintiff asks this Court to enter judgment against Defendants and against Defendants’ subsidiaries, affiliates, agents, servants, employees and all persons in active concert or participation with them, granting the following relief:

- A. An award of damages adequate to compensate Plaintiff for the infringement that has occurred, together with prejudgment interest from the date infringement of the ‘500, ‘158 and ‘492 Patents began;
- B. An award to Plaintiff of all remedies available under 35 U.S.C. § 284;
- C. An award to Plaintiff of all remedies available under 35 U.S.C. § 285;
- D. A permanent injunction under 35 U.S.C. § 283 prohibiting further infringement of the ‘500, ‘158 and ‘492 Patents, and, in the alternative, in the event injunctive relief is not granted as requested by Plaintiff, an award of a compulsory future royalty; and
- E. Such other and further relief as this Court or a jury may deem proper and just.

JURY DEMAND

Plaintiff demands a trial by jury on all issues so triable

Dated: November 9, 2012

HOPKINS & CARLEY
A Law Corporation

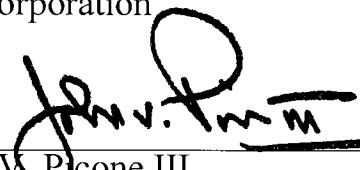
By: 

 John W. Picone III
 Attorneys for Plaintiff
 PI-NET INTERNATIONAL, INC.

EXHIBIT A



US005987500A

United States Patent [19]
Arunachalam

[11] **Patent Number:** **5,987,500**
 [45] **Date of Patent:** ***Nov. 16, 1999**

[54] **VALUE-ADDED NETWORK SYSTEM FOR ENABLING REAL-TIME, BY-DIRECTIONAL TRANSACTIONS ON A NETWORK**

[75] Inventor: **Lakshmi Arunachalam**, Menlo Park, Calif.

[73] Assignee: **Pi-Net International, Inc.**, Menlo Park, Calif.

[*] Notice: This patent issued on a continued prosecution application filed under 37 CFR 1.53(d), and is subject to the twenty year patent term provisions of 35 U.S.C. 154(a)(2).

[21] Appl. No.: **08/879,958**

[22] Filed: **Jun. 20, 1997**

Related U.S. Application Data

[62] Division of application No. 08/700,726, Aug. 5, 1996, Pat. No. 5,778,178

[60] Provisional application No. 60/006,634, Nov. 13, 1995.

[51] **Int. Cl.⁶** **G06F 13/00**

[52] **U.S. Cl.** **709/203**

[58] **Field of Search** 364/DIG. 1, DIG. 2; 395/762, 200.3, 200.31, 200.32, 200.43, 681, 682, 683, 684, 685, 689; 709/200, 201, 202, 203, 213, 301, 302, 303, 304, 305; 710/200

[56] **References Cited**
PUBLICATIONS

“Coding with HTML forms: HTML goes interactive”, Andrew Davidson, Dr. Dobb’s Journal, V20, N6, Jun. 1995, p. 16.

Primary Examiner—Robert B. Harrell
Attorney, Agent, or Firm—Blakely, Sokoloff, Taylor & Zafman LLP

[57] **ABSTRACT**

The present invention provides a method and apparatus for providing real-time, two-way transactional capabilities on the Web. Specifically, one embodiment of the present invention discloses a configurable value-added network switch for enabling real-time transactions on the World Wide Web. The configurable value added network switch comprises a system for switching to a transactional application in response to a user specification from a World Wide Web application, a system means for transmitting a transaction request from the transactional application, and a system for processing the transaction request. Additionally, a method for enabling object routing is disclosed, comprising the steps of creating a virtual information store containing information entries and attributes associating each of the information entries and the attributes with an object identity, and assigning a unique network address to each of the object identities. Finally, a method is disclosed for enabling service management of the value-added network service, to perform OAM&P functions on the services network.

35 Claims, 13 Drawing Sheets

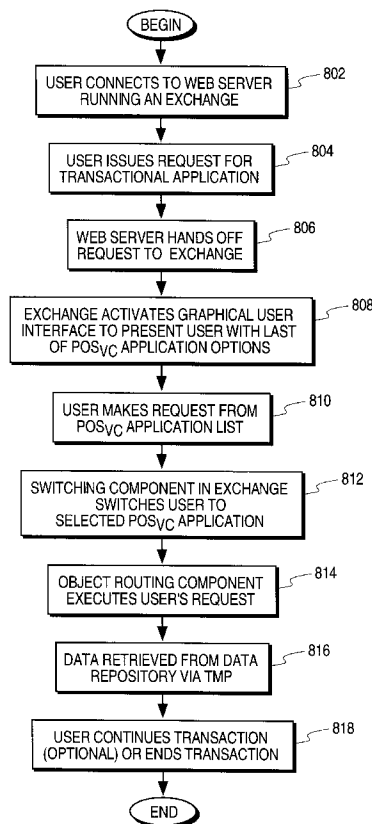

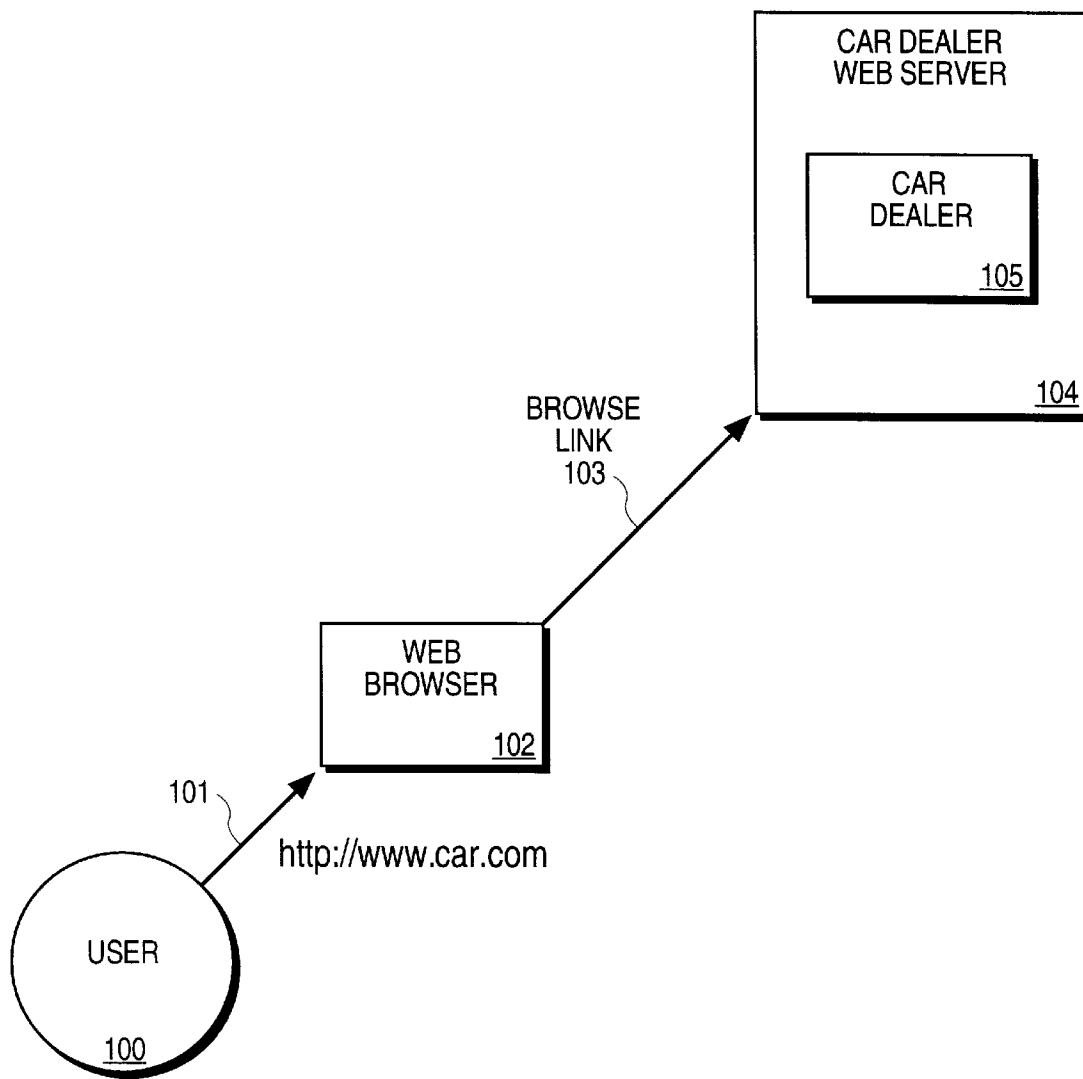

FIG. 1A (PRIOR ART)

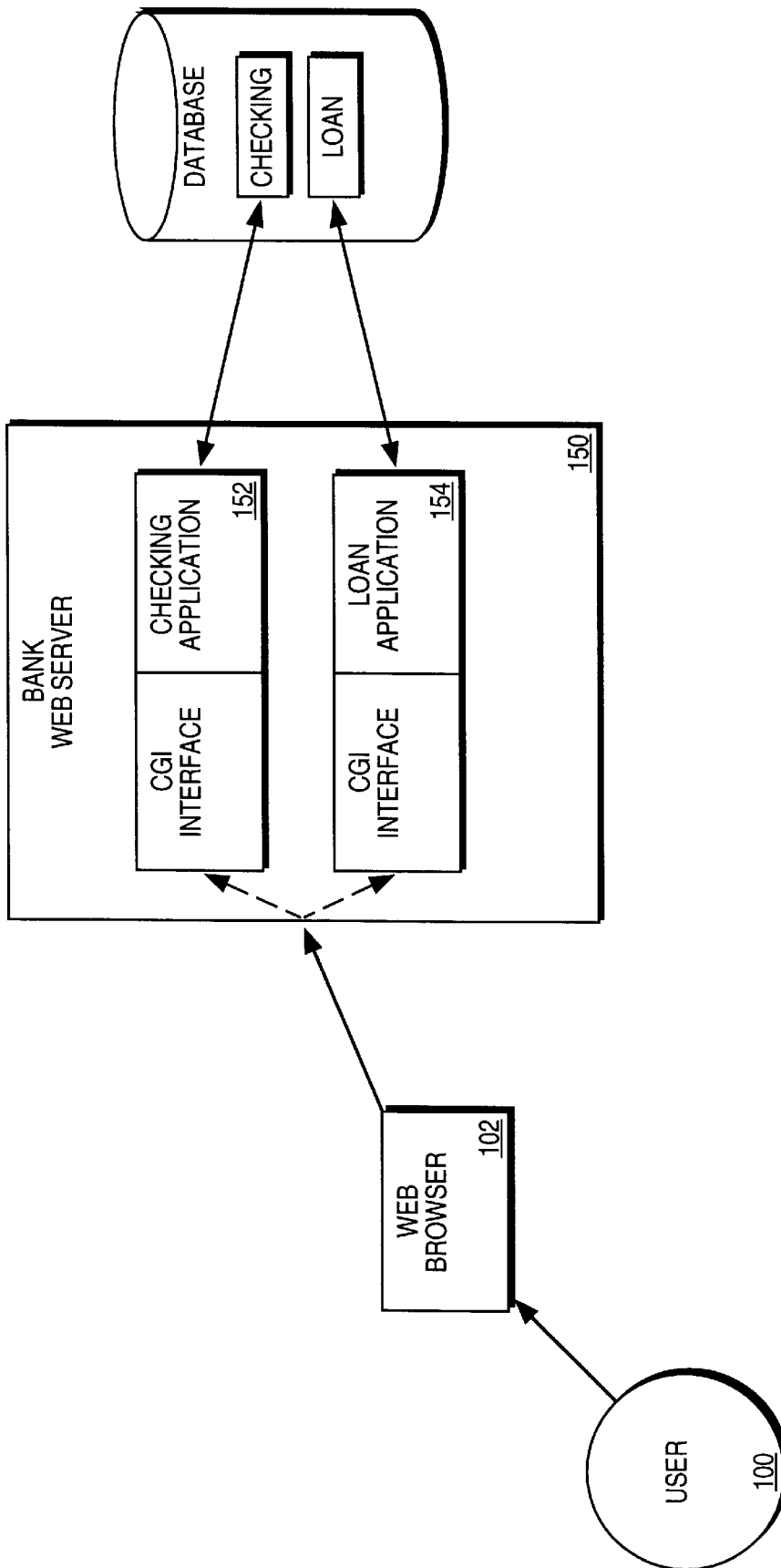

FIG. 1B (PRIOR ART)

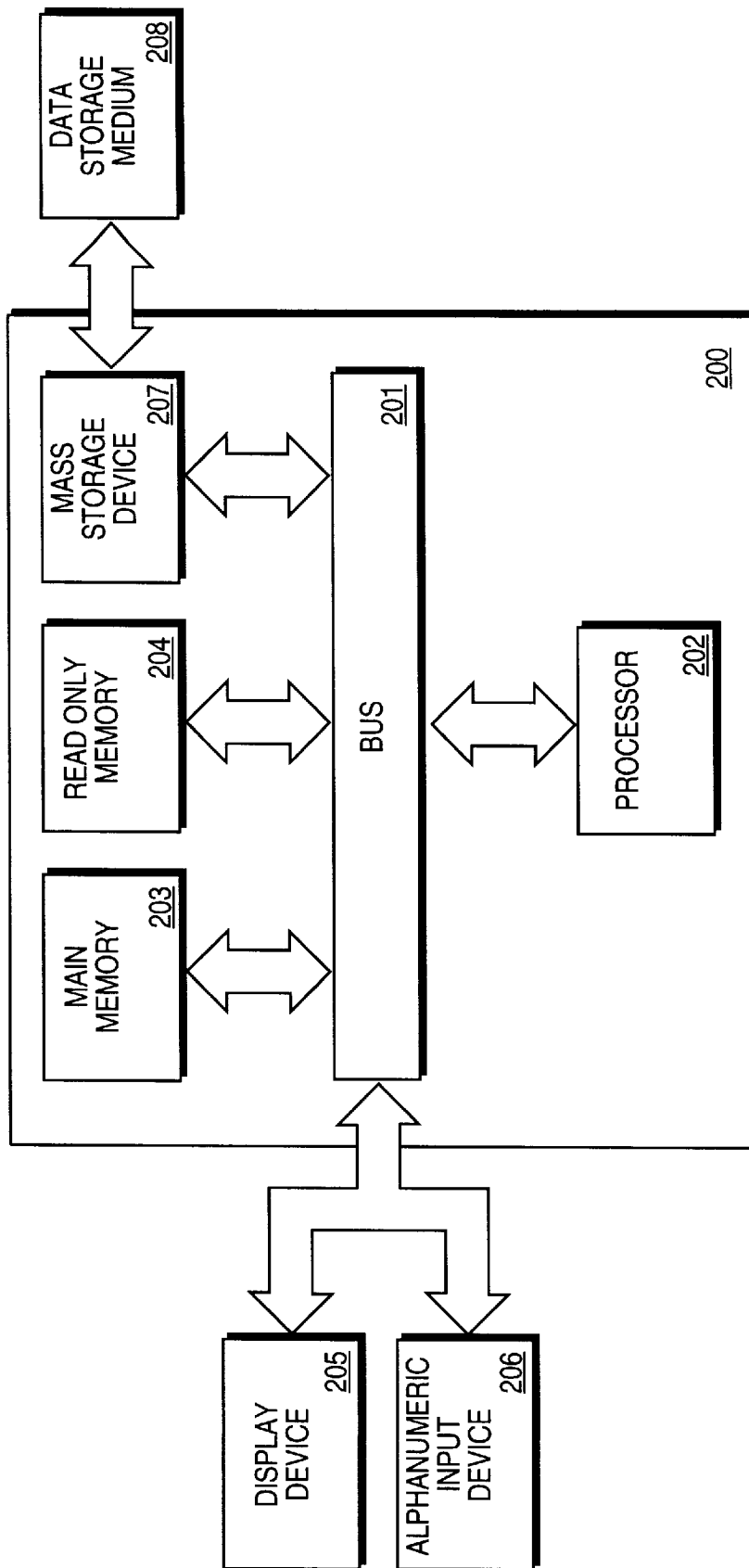

FIG. 2

OSI MODEL
300

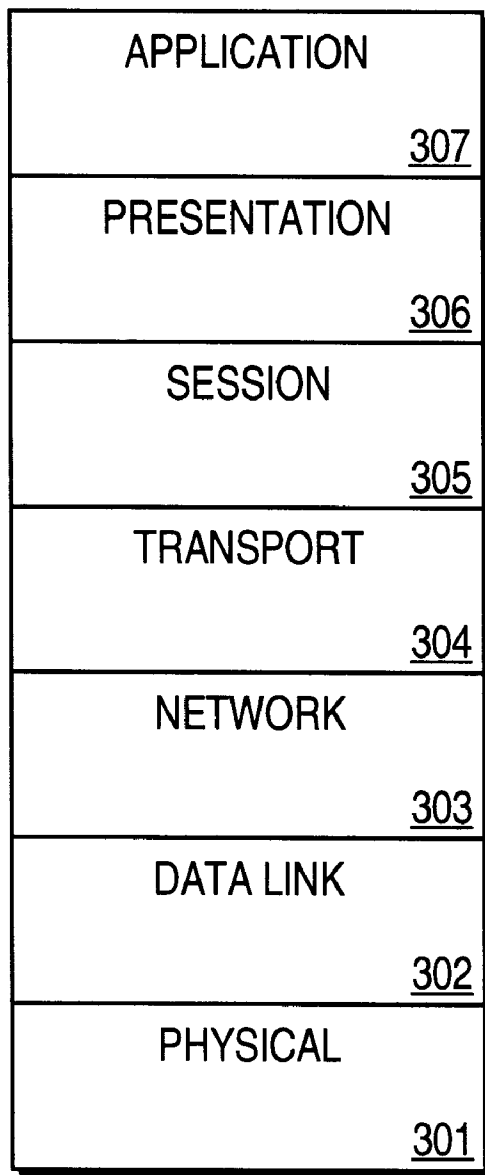
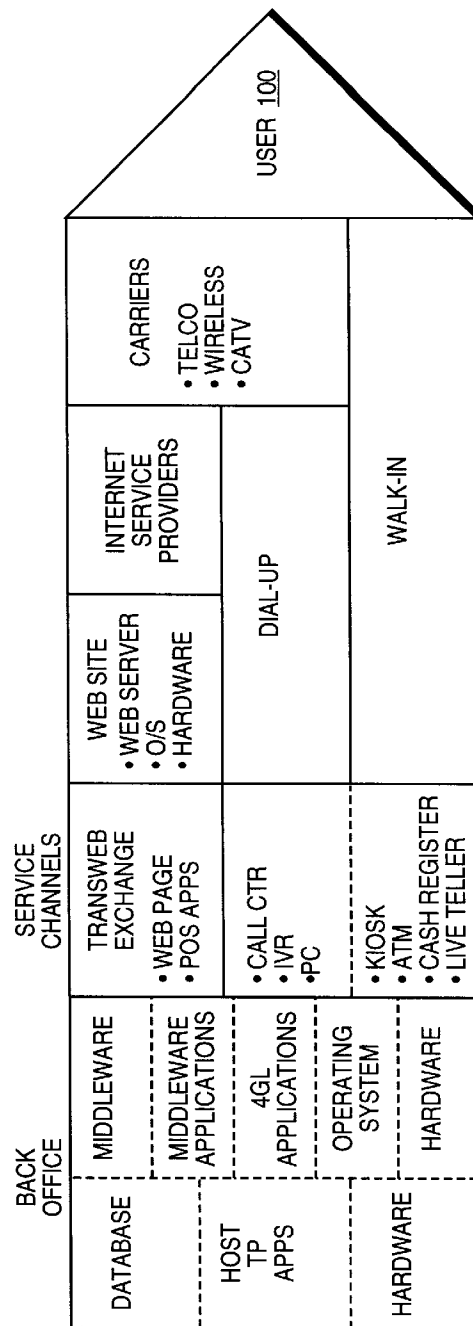
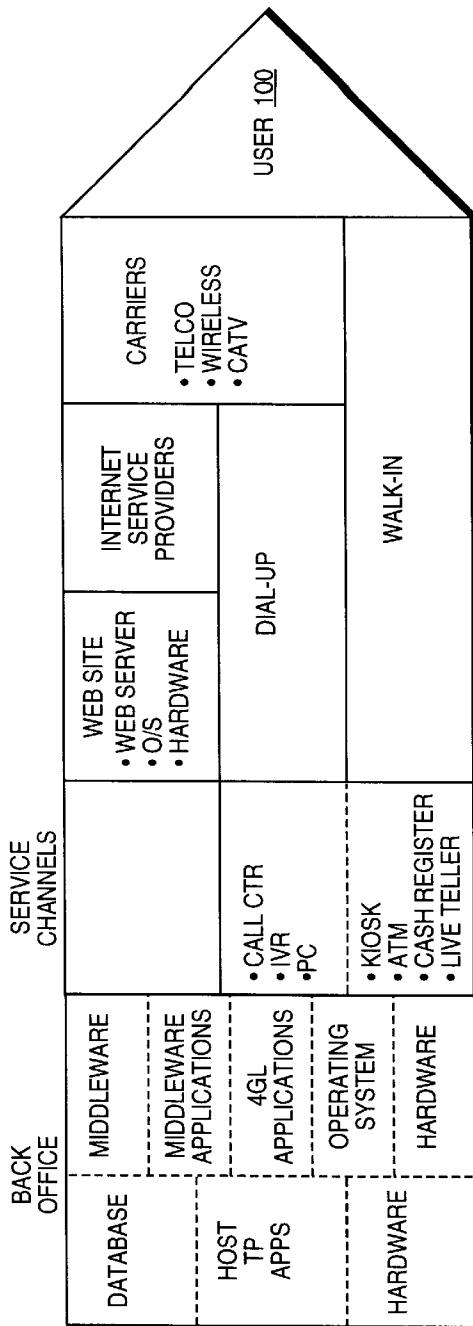

FIG. 3



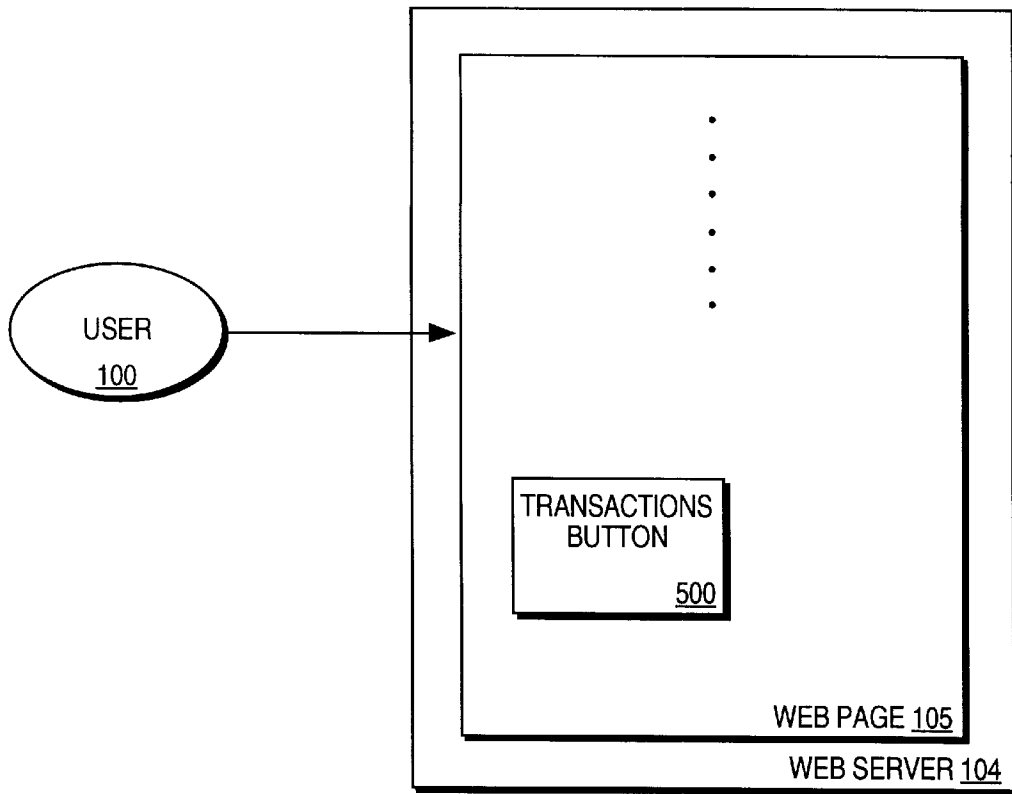

FIG. 5A

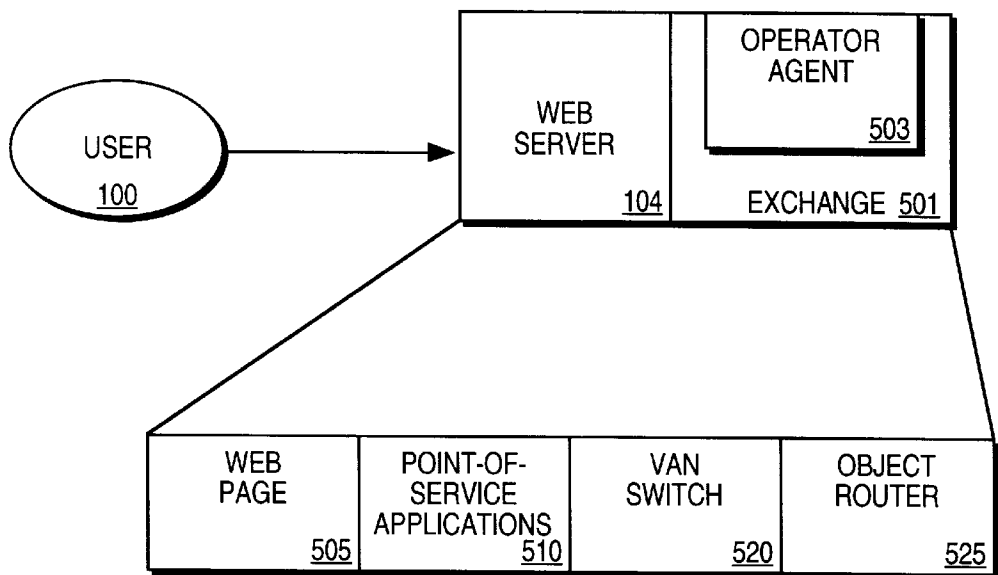

FIG. 5B

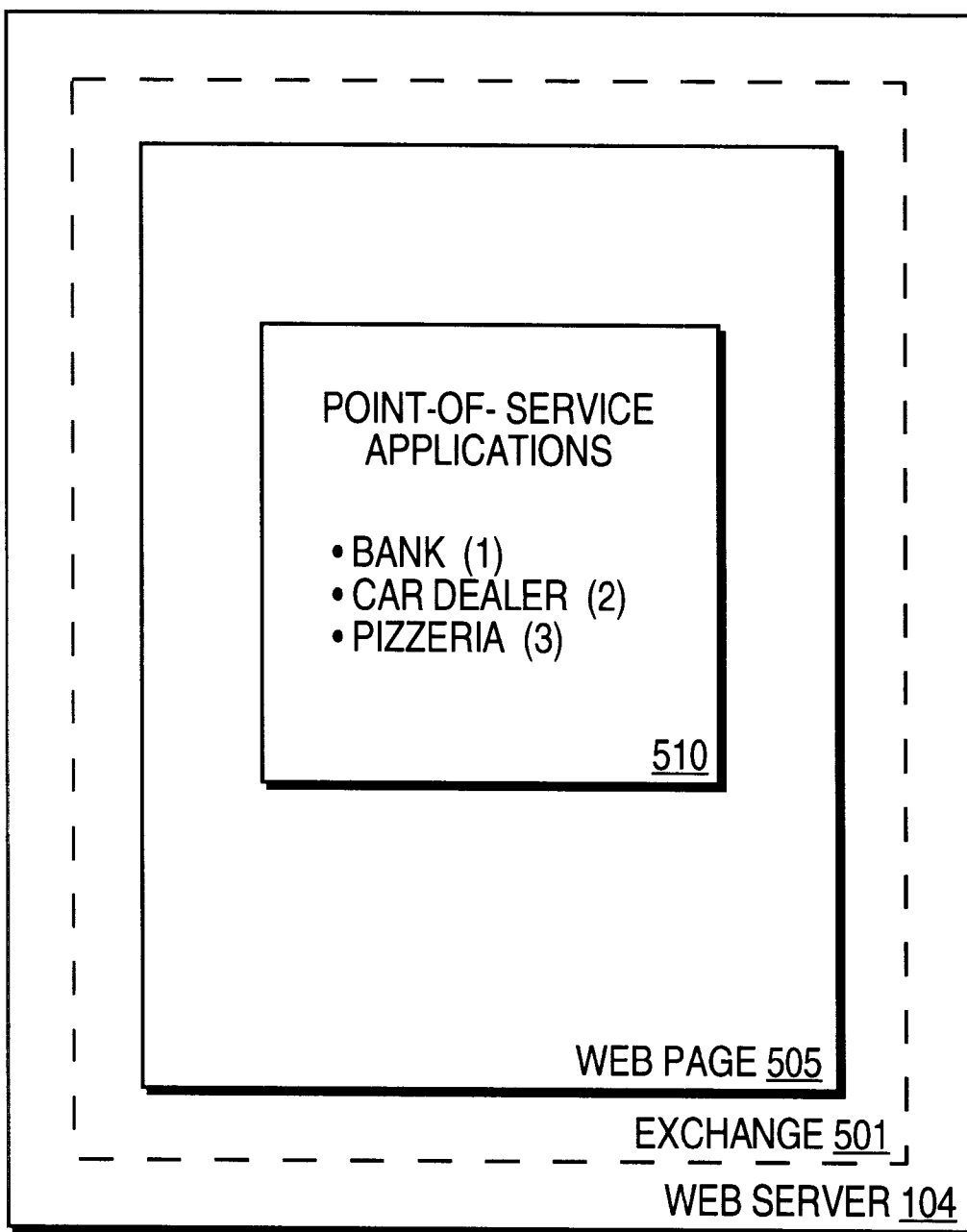

FIG. 5C

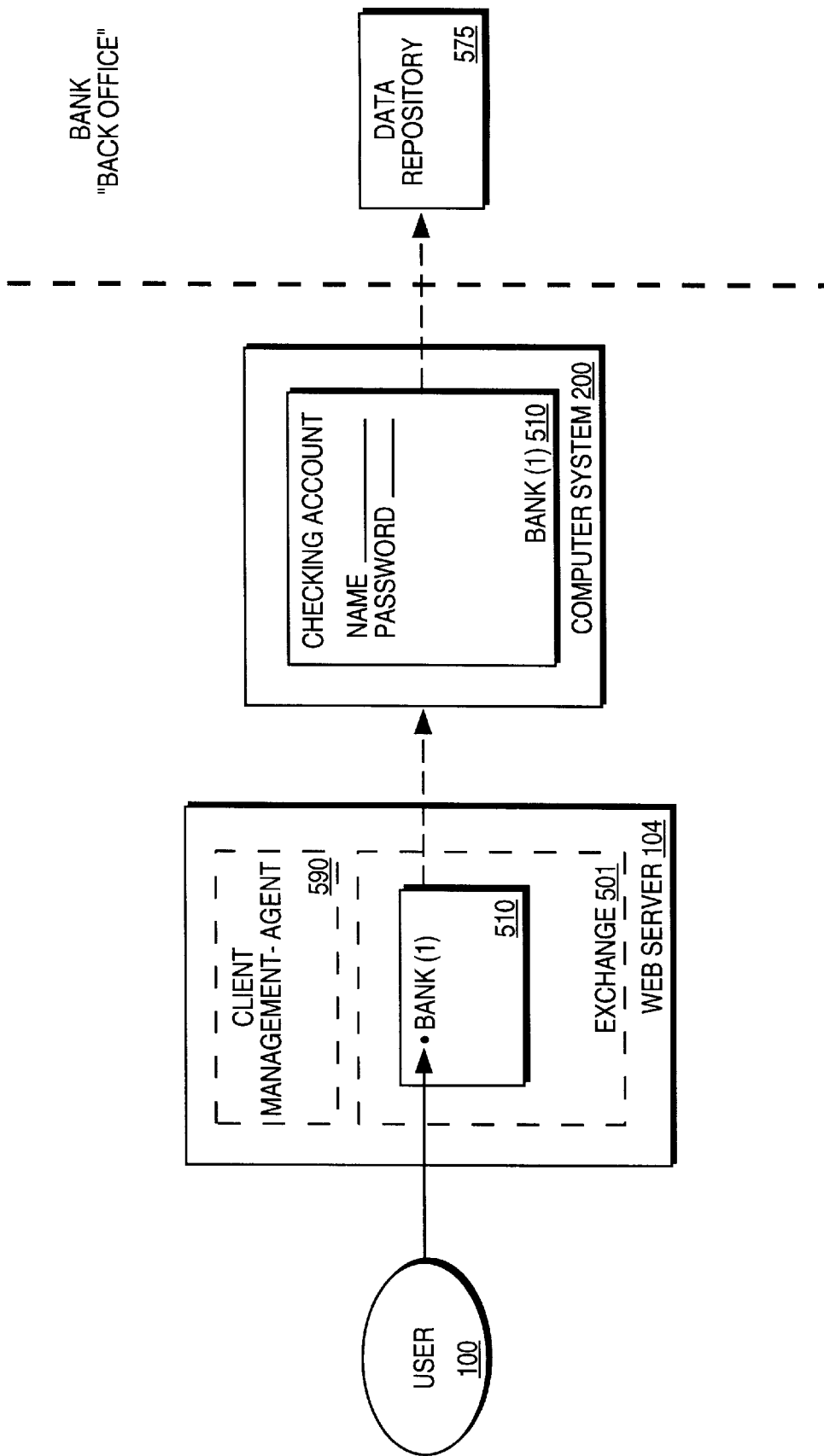

FIG. 5D

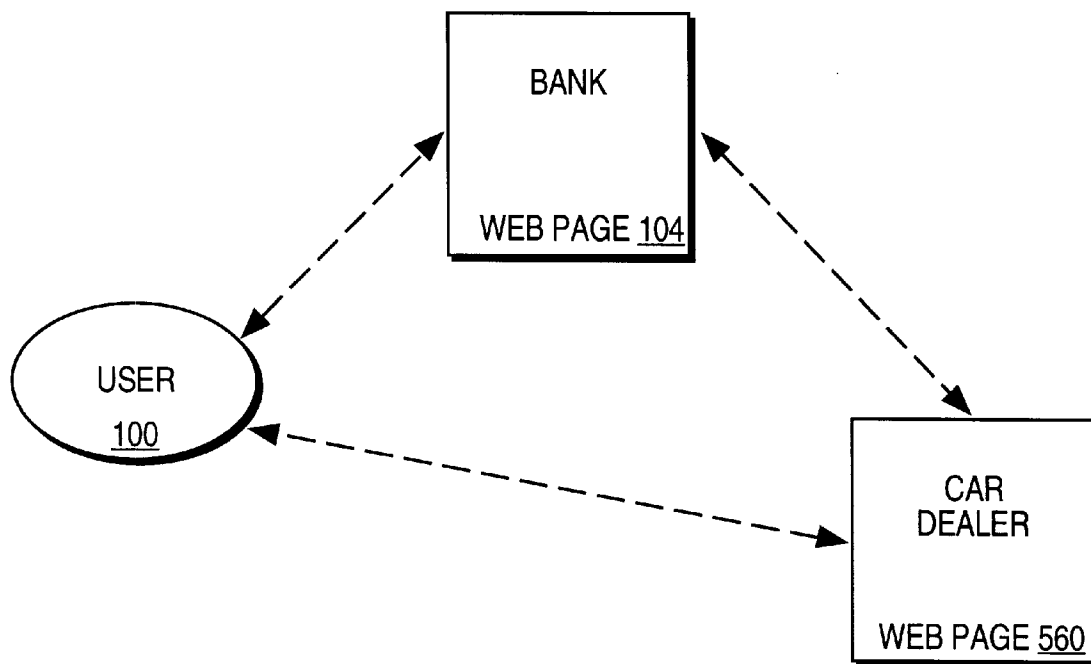

FIG. 5E

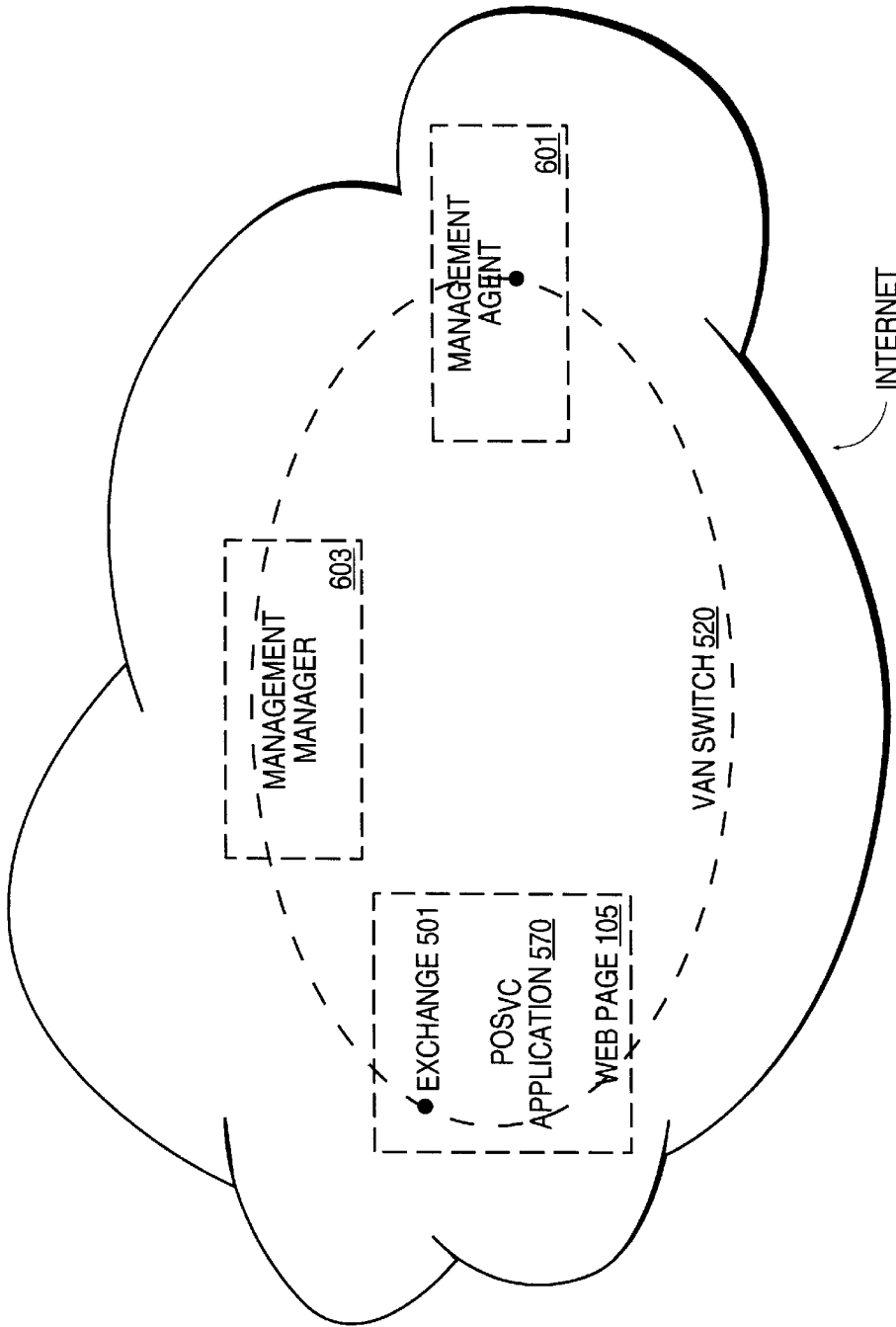

FIG. 6A

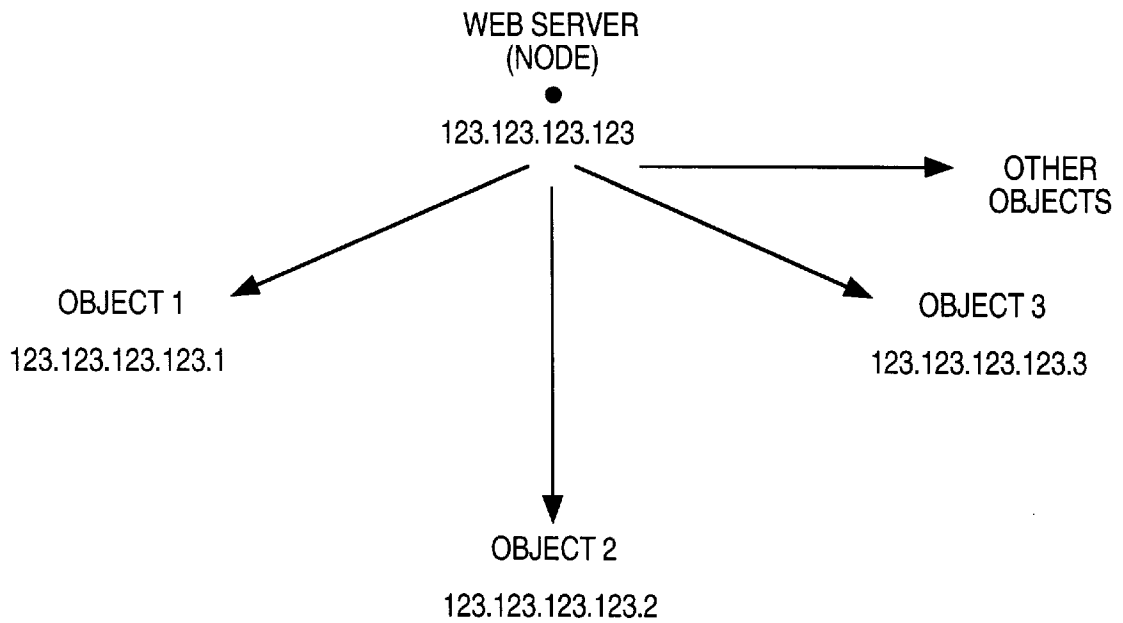

FIG. 6B

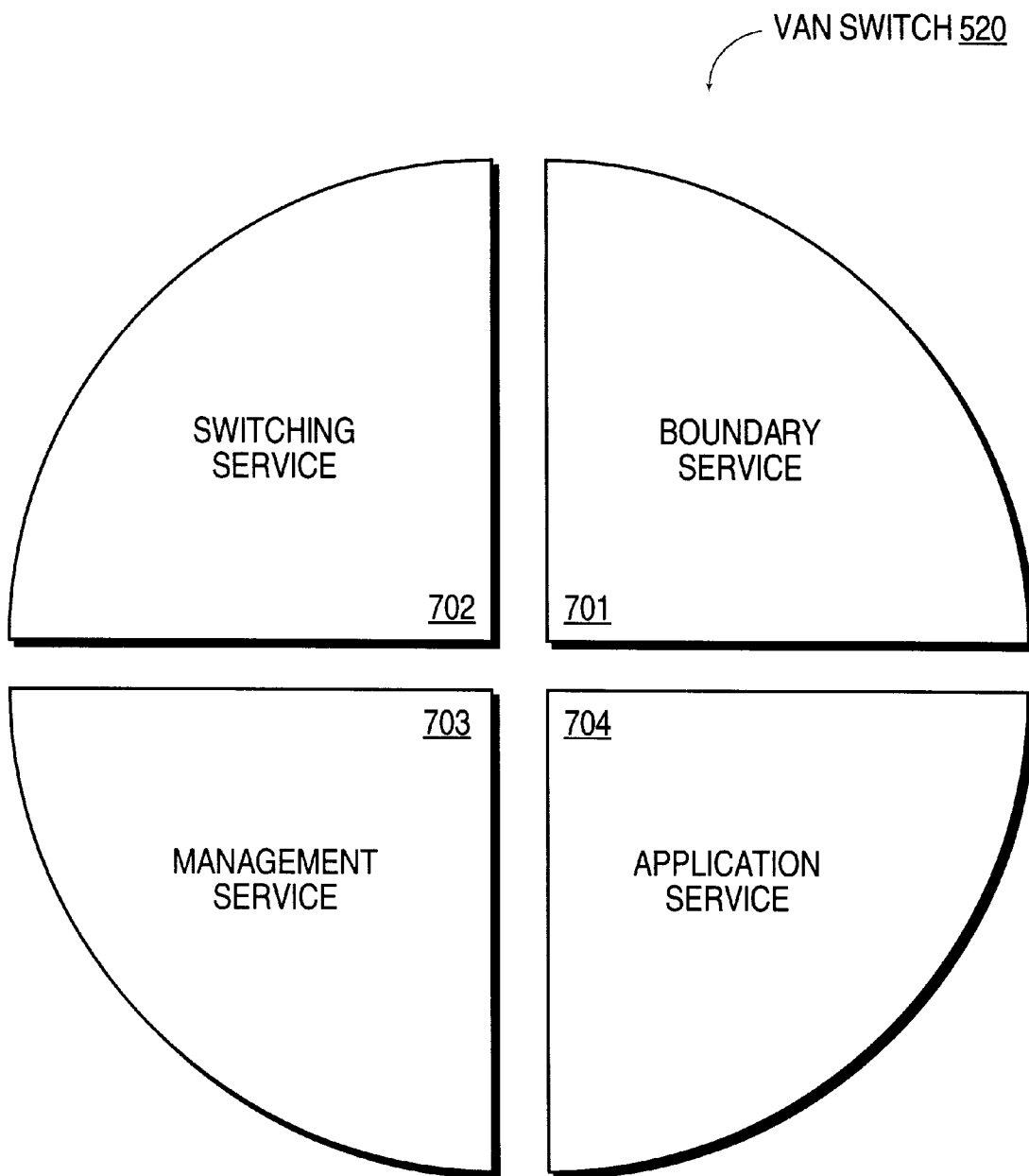

FIG. 7

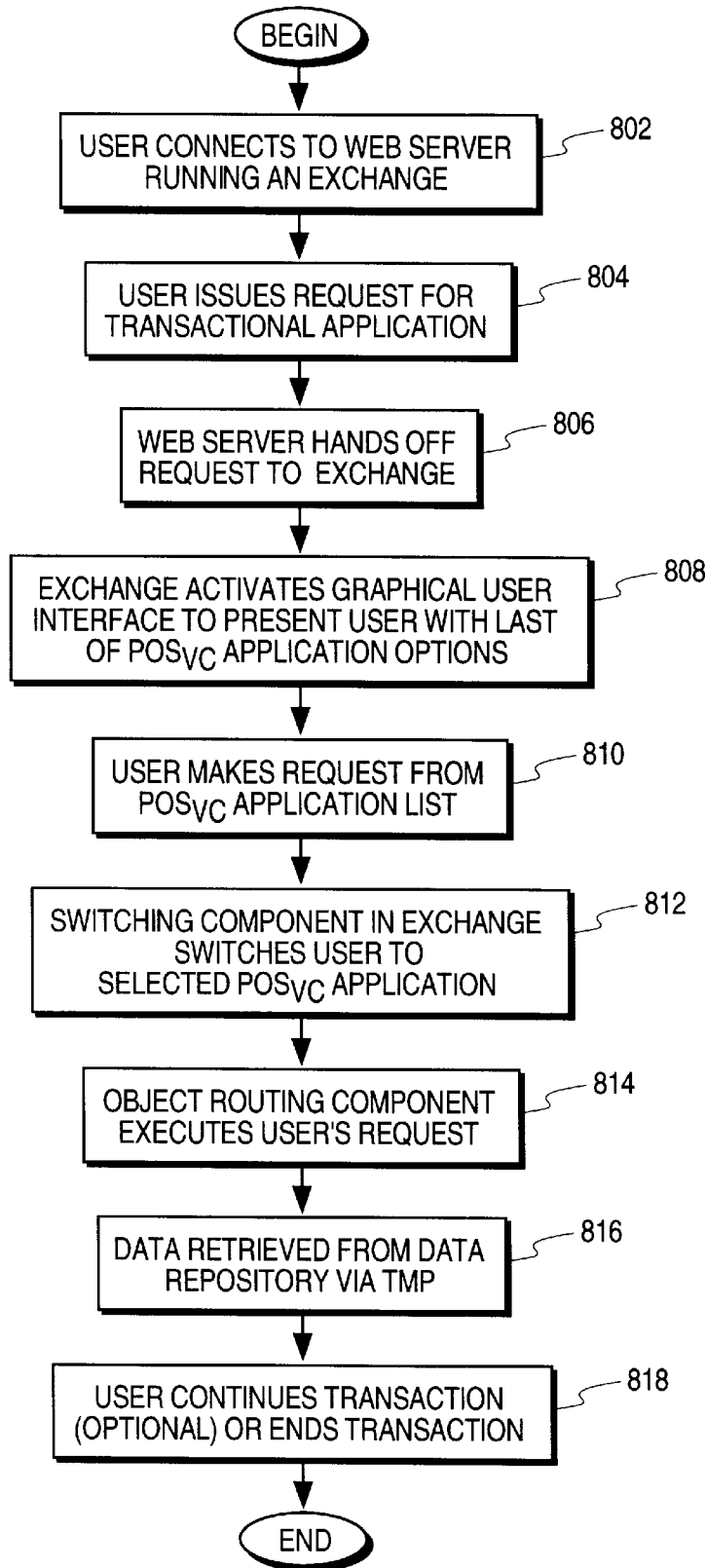

FIG. 8

5,987,500

1

VALUE-ADDED NETWORK SYSTEM FOR ENABLING REAL-TIME, BY-DIRECTIONAL TRANSACTIONS ON A NETWORK

RELATED APPLICATIONS

This is a divisional of application Ser. No. 08/700,726, filed Aug. 5, 1996, now U.S. Pat. No. 5,778,178.

FIELD OF THE INVENTION

The present invention relates to the area of Internet communications. Specifically, the present invention relates to a method and apparatus for configurable value-added network switching and object routing.

BACKGROUND OF THE INVENTION

With the Internet and the World Wide Web ("the Web") evolving rapidly as a viable consumer medium for electronic commerce, new on-line services are emerging to fill the needs of on-line users. An Internet user today can browse on the Web via the use of a Web browser. Web browsers are software interfaces that run on Web clients to allow access to Web servers via a simple user interface. A Web user's capabilities today from a Web browser are, however, extremely limited. The user can perform one-way, browse-only interactions. Additionally, the user has limited "deferred" transactional capabilities, namely electronic mail (e-mail) capabilities. E-mail capabilities are referred to as "deferred transactions" because the consumer's request is not processed until the e-mail is received, read, and the person or system reading the e-mail executes the transaction. This transaction is thus not performed in real-time.

FIG. 1A illustrates typical user interactions on the Web today. User **100** sends out a request from Web browser **102** in the form of a universal resource locator (URL) **101** in the following manner: <http://www.car.com>. URL **101** is processed by Web browser **102** that determines the URL corresponds to car dealer Web page **105**, on car dealer Web server **104**. Web browser **102** then establishes browse link **103** to car dealer Web page **105**. User **100** can browse Web page **105** and select "hot links" to jump to other locations in Web page **105**, or to move to other Web pages on the Web. This interaction is typically a browse-only interaction. Under limited circumstances, the user may be able to fill out a form on car dealer Web page **105**, and e-mail the form to car dealer Web server **104**. This interaction is still strictly a one-way browse mode communications link, with the e-mail providing limited, deferred transactional capabilities.

Under limited circumstances, a user may have access to two-way services on the Web via Common Gateway Interface (CGI) applications. CGI is a standard interface for running external programs on a Web server. It allows Web servers to create documents dynamically when the server receives a request from the Web browser. When the Web server receives a request for a document, the Web server dynamically executes the appropriate CGI script and transmits the output of the execution back to the requesting Web browser. This interaction can thus be termed a "two-way" transaction. It is a severely limited transaction, however, because each CGI application is customized for a particular type of application or service.

For example, as illustrated in FIG. 1B, user **100** may access bank **150**'s Web server and attempt to perform transactions on checking account **152** and to make a payment on loan account **154**. In order for user **100** to access checking account **152** and loan account **154** on the Web, CGI

2

application scripts must be created for each account, as illustrated in FIG. 1B. The bank thus has to create individual scripts for each of its services to offer users access to these services. User **100** can then interact in a limited fashion with these individual applications. Creating and managing individual CGI scripts for each service is not a viable solution for merchants with a large number of services.

As the Web expands and electronic commerce becomes more desirable, the need increases for robust, real-time, bi-directional transactional capabilities on the Web. A true real-time, bi-directional transaction would allow a user to connect to a variety of services on the Web, and perform real-time transactions on those services. For example, although user **100** can browse car dealer Web page **105** today, the user cannot purchase the car, negotiate a car loan or perform other types of real-time, two-way transactions that he can perform with a live salesperson at the car dealership. Ideally, user **100** in FIG. 1A would be able to access car dealer Web page **105**, select specific transactions that he desires to perform, such as purchase a car, and perform the purchase in real-time, with two-way interaction capabilities. CGI applications provide user **100** with a limited ability for two-way interaction with car dealer Web page **105**, but due to the lack of interaction and management between the car dealer and the bank, he will not be able to obtain a loan and complete the purchase of the car via a CGI application. The ability to complete robust real-time, two-way transactions is thus not truly available on the Web today.

SUMMARY OF THE INVENTION

It is therefore an object of the present invention to provide a method and apparatus for providing real-time, two-way transactional capabilities on the Web. Specifically, one embodiment of the present invention discloses a configurable value-added network switch for enabling real-time transactions on the World Wide Web. The configurable value added network switch comprises means for switching to a transactional application in response to a user specification from a World Wide Web application, means for transmitting a transaction request from the transactional application, and means for processing the transaction request.

According to another aspect of the present invention, a method and apparatus for enabling object routing on the World Wide Web is disclosed. The method for enabling object routing comprises the steps of creating a virtual information store containing information entries and attributes, associating each of the information entries and the attributes with an object identity, and assigning a unique network address to each of the object identities.

Other objects, features and advantages of the present invention will be apparent from the accompanying drawings and from the detailed description.

BRIEF DESCRIPTION OF THE DRAWINGS

The features and advantages of the present invention will be apparent from the accompanying drawings and from the detailed description of the present invention as set forth below.

FIG. 1A is an illustration of a current user's browse capabilities on the Web via a Web browser.

FIG. 1B is an illustration of a current user's capabilities to perform limited transactions on the Web via CGI applications.

FIG. 2 illustrates a typical computer system on which the present invention may be utilized.

5,987,500

3

FIG. 3 illustrates the Open Systems Interconnection (OSI) Model.

FIG. 4A illustrates conceptually the user value chain as it exists today.

FIG. 4B illustrates one embodiment of the present invention.

FIG. 5A illustrates a user accessing a Web server including one embodiment of the present invention.

FIG. 5B illustrates the exchange component according to one embodiment of the present invention.

FIG. 5C illustrates an example of a point-of-service (POSvc) application list.

FIG. 5D illustrates a user selecting a bank POSvc application from the POSvc application list.

FIG. 5E illustrates a three-way transaction according to one embodiment of the present invention.

FIG. 6A illustrates a value-added network (VAN) switch.

FIG. 6B illustrates the hierarchical addressing tree structure of the networked objects in DOLSIBs.

FIG. 7 illustrates conceptually the layered architecture of a VAN switch.

FIG. 8 is a flow diagram illustrating one embodiment of the present invention.

DETAILED DESCRIPTION OF THE PREFERRED EMBODIMENT

The present invention relates to a method and apparatus for configurable value-added network switching and object routing and management. "Web browser" as used in the context of the present specification includes conventional Web browsers such as NCSA Mosaic™ from NCSA and Netscape Mosaic™ from Netscape™. The present invention is independent of the Web browser being utilized and the user can use any Web browser, without modifications to the Web browser. In the following detailed description, numerous specific details are set forth in order to provide a thorough understanding of the present invention. It will be apparent to one of ordinary skill in the art, however, that these specific details need not be used to practice the present invention. In other instances, well-known structures, interfaces and processes have not been shown in detail in order not to unnecessarily obscure the present invention.

FIG. 2 illustrates a typical computer system 200 in which the present invention operates. The preferred embodiment of the present invention is implemented on an IBM™ Personal Computer manufactured by IBM Corporation of Armonk, N.Y. Alternate embodiments may be implemented on a Macintosh™ computer manufactured by Apple™ Computer, Incorporated of Cupertino, Calif. It will be apparent to those of ordinary skill in the art that other alternative computer system architectures may also be employed.

In general, such computer systems as illustrated by FIG. 2 comprise a bus 201 for communicating information, a processor 202 coupled with the bus 201 for processing information, main memory 203 coupled with the bus 201 for storing information and instructions for the processor 202, a read-only memory 204 coupled with the bus 201 for storing static information and instructions for the processor 202, a display device 205 coupled with the bus 201 for displaying information for a computer user, an input device 206 coupled with the bus 201 for communicating information and command selections to the processor 202, and a mass storage device 207, such as a magnetic disk and associated disk drive, coupled with the bus 201 for storing information

4

and instructions. A data storage medium 208 containing digital information is configured to operate with mass storage device 207 to allow processor 202 access to the digital information on data storage medium 208 via bus 201.

Processor 202 may be any of a wide variety of general purpose processors or microprocessors such as the Pentium™ microprocessor manufactured by Intel™ Corporation or the Motorola™ 68040 or Power PC™ brand microprocessor manufactured by manufactured by Motorola™ Corporation. It will be apparent to those of ordinary skill in the art, however, that other varieties of processors may also be used in a particular computer system. Display device 205 may be a liquid crystal device, cathode ray tube (CRT), or other suitable display device. Mass storage device 207 may be a conventional hard disk drive, floppy disk drive, CD-ROM drive, or other magnetic or optical data storage device for reading and writing information stored on a hard disk, a floppy disk, a CD-ROM a magnetic tape, or other magnetic or optical data storage medium. Data storage medium 208 may be a hard disk, a floppy disk, a CD-ROM, a magnetic tape, or other magnetic or optical data storage medium.

In general, processor 202 retrieves processing instructions and data from a data storage medium 208 using mass storage device 207 and downloads this information into random access memory 203 for execution. Processor 202, then executes an instruction stream from random access memory 203 or read-only memory 204. Command selections and information input at input device 206 are used to direct the flow of instructions executed by processor 202. Equivalent input device 206 may also be a pointing device such as a conventional mouse or trackball device. The results of this processing execution are then displayed on display device 205.

The preferred embodiment of the present invention is implemented as a software module, which may be executed on a computer system such as computer system 200 in a conventional manner. Using well known techniques, the application software of the preferred embodiment is stored on data storage medium 208 and subsequently loaded into and executed within computer system 200. Once initiated, the software of the preferred embodiment operates in the manner described below.

FIG. 3 illustrates the Open Systems Interconnection (OSI) reference model. OSI Model 300 is an international standard that provides a common basis for the coordination of standards development, for the purpose of systems interconnection. The present invention is implemented to function as a routing switch within the "application layer" of the OSI model. The model defines seven layers, with each layer communicating with its peer layer in another node through the use of a protocol. Physical layer 301 is the lowest layer, with responsibility to transmit unstructured bits across a link. Data link layer 302 is the next layer above physical layer 301. Data link layer 302 transmits chunks across the link and deals with problems like checksumming to detect data corruption, orderly coordination of the use of shared media and addressing when multiple systems are reachable. Network bridges operate within data link layer 302.

Network layer 303 enables any pair of systems in the network to communicate with each other. Network layer 303 contains hardware units such as routers, that handle routing, packet fragmentation and reassembly of packets. Transport layer 304 establishes a reliable communication stream between a pair of systems, dealing with errors such as lost packets, duplicate packets, packet reordering and fragmen-

5,987,500

5

tation. Session layer **305** offers services above the simple communication stream provided by transport layer **304**. These services include dialog control and chaining. Presentation layer **306** provides a means by which OSI compliant applications can agree on representations for data. Finally, application layer **307** includes services such as file transfer, access and management services (FTAM), electronic mail and virtual terminal (VT) services. Application layer **307** provides a means for application programs to access the OSI environment. As described above, the present invention is implemented to function as a routing switch in application layer **307**. Application layer routing creates an open channel for the management, and the selective flow of data from remote databases on a network.

A. Overview

FIG. 4A illustrates conceptually the user value chain as it exists today. The user value chain in FIG. 4A depicts the types of transactions that are performed today, and the channels through which the transactions are performed. A “transaction” for the purposes of the present invention includes any type of commercial or other type of interaction that a user may want to perform. Examples of transactions include a deposit into a bank account, a request for a loan from a bank, a purchase of a car from a car dealership or a purchase of a car with financing from a bank. A large variety of other transactions are also possible.

A typical user transaction today may involve user **100** walking into a bank or driving up to a teller machine, and interacting with a live bank teller, or automated teller machine (ATM) software applications. Alternatively, user **100** can perform the same transaction by using a personal computer (PC), activating application software on his PC to access his bank account, and dialing into the bank via a modem line. If user **100** is a Web user, however, there is no current mechanism for performing a robust, real-time transaction with the bank, as illustrated in FIG. 4A. CGI scripts provide only limited two-way capabilities, as described above. Thus, due to this lack of a robust mechanism by which real-time Web transactions can be performed, the bank is unable to be a true “Web merchant,” namely a merchant capable of providing complete transactional services on the Web.

According to one embodiment of the present invention, as illustrated in FIG. 4B, each merchant that desires to be a Web merchant can provide real-time transactional capabilities to users who desire to access the merchants’ services via the Web. This embodiment includes a service network running on top of a facilities network, namely the Internet, the Web or e-mail networks. For the purposes of this application, users are described as utilizing PC’s to access the Web via Web server “switching” sites. (Switching is described in more detail below). Users may also utilize other personal devices such as network computers or cellular devices to access the merchants’ services via appropriate switching sites. These switching sites include non-Web network computer sites and cellular provider sites. Five components interact to provide this service network functionality, namely an exchange, an operator agent, a management agent, a management manager and a graphical user interface. All five components are described in more detail below.

As illustrated in FIG. 5A, user **100** accesses Web server **104**. Having accessed Web server **104**, user **100** can decide that he desires to perform real-time transactions. When Web server **104** receives user **100**’s indication that he desires to perform real-time transactions, the request is handed over to an exchange component. Thus, from Web page **105**, for

6

example, user **100** can select button **500**, entitled “Transactions” and Web server **104** hands user **100**’s request over to the exchange component. The button and the title can be replaced by any mechanism that can instruct a Web server to hand over the consumer’s request to the exchange component.

FIG. 5B illustrates exchange **501**. Exchange **501** comprises Web page **505** and point-of-service (POSvc) applications **510**. Exchange **501** also conceptually includes a switching component and an object routing component (described in more detail below). POSvc applications **510** are transactional applications, namely applications that are designed to incorporate and take advantage of the capabilities provided by the present invention. Although exchange **501** is depicted as residing on Web server **104**, the exchange can also reside on a separate computer system that resides on the Internet and has an Internet address. Exchange **501** may also include operator agent **503** that interacts with a management manager (described in more detail below). Exchange **501** creates and allows for the management (or distributed control) of a service network, operating within the boundaries of an IP-based facilities network. Thus, exchange **501** and a management agent component, described in more detail below, under the headings “VAN Switch and Object Routing,” together perform the switching, object routing, application and service management functions according to one embodiment of the present invention.

Exchange **501** processes the consumer’s request and displays an exchange Web page **505** that includes a list of POSvc applications **510** accessible by exchange **501**. A POSvc application is an application that can execute the type of transaction that the user may be interested in performing. The POSvc list is displayed via the graphical user interface component. One embodiment of the present invention supports HyperText Markup Language as the graphical user interface component. Virtual Reality Markup Language and Java™ are also supported by this embodiment. A variety of other graphical user interface standards can also be utilized to implement the graphical user interface.

An example of a POSvc application list is illustrated in FIG. 5C. User **100** can thus select from POSvc applications Bank **510(1)**, Car Dealer **510(2)** or Pizzeria **510(3)**. Numerous other POSvc applications can also be included in this selection. If user **100** desires to perform a number of banking transactions, and selects the Bank application, a Bank POSvc application will be activated and presented to user **100**, as illustrated in FIG. 5D. For the purposes of illustration, exchange **501** in FIG. 5D is shown as running on a different computer system (Web server **104**) from the computer systems of the Web merchants running POSvc applications (computer system **200**). Exchange **501** may, however, also be on the same computer system as one or more of the computer systems of the Web merchants.

Once Bank POSvc application **510** has been activated, user **100** will be able to connect to Bank services and utilize the application to perform banking transactions, thus accessing data from a host or data repository **575** in the Bank “Back Office.” The Bank Back Office comprises legacy databases and other data repositories that are utilized by the Bank to store its data. This connection between user **100** and Bank services is managed by exchange **501**. As illustrated in FIG. 5D, once the connection is made between Bank POSvc application **510(1)**, for example, and Bank services, an operator agent on Web server **104** may be activated to ensure the availability of distributed functions and capabilities.

Each Web merchant may choose the types of services that it would like to offer its clients. In this example, if Bank

5,987,500

7

decided to include in their POSvc application access to checking and savings accounts, user **100** will be able to perform real-time transactions against his checking and savings accounts. Thus, if user **100** moves \$500 from his checking account into his savings account, the transaction will be performed in real-time, in the same manner the transaction would have been performed by a live teller at the bank or an ATM machine. Therefore, unlike his prior access to his account, user **100** now has the capability to do more than browse his bank account. The ability to perform these types of robust, real-time transactions from a Web client is a significant aspect of the present invention.

Bank can also decide to provide other types of services in POSvc application **510(1)**. For example, Bank may agree with Car dealership to allow Bank customers to purchase a car from that dealer, request a car loan from Bank, and have the entire transaction performed on the Web, as illustrated in FIG. **5E**. In this instance, the transactions are not merely two-way, between the user and Bank, but three-way, amongst the consumer, Bank and Car dealership. According to one aspect of the present invention, this three-way transaction can be expanded to n-way transactions, where n represents a predetermined number of merchants or other service providers who have agreed to cooperate to provide services to users. The present invention therefore allows for "any-to-any" communication and transactions on the Web, thus facilitating a large, flexible variety of robust, real-time transactions on the Web.

Finally, Bank may also decide to provide intra-merchant or intra-bank services, together with the inter-merchant services described above. For example, if Bank creates a POSvc application for use by the Bank Payroll department, Bank may provide its own employees with a means for submitting timecards for payroll processing by the Bank's Human Resources (HR) Department. An employee selects the Bank HR POSvc application, and submits his timecard. The employee's timecard is processed by accessing the employee's payroll information, stored in the Bank's Back Office. The transaction is thus processed in real-time, and the employee receives his paycheck immediately.

B. Van Switching and Object Routing

As described above, exchange **501** and management agent **601**, illustrated in FIG. **6A**, together constitute a value-added network (VAN) switch. These two elements may take on different roles as necessary, including peer-to-peer, client-server or master-slave roles. Management manager **603** is illustrated as residing on a separate computer system on the Internet. Management manager **603** can, however, also reside on the same machine as exchange **501**. Management manager **603** interacts with the operator agent **503** residing on exchange **501**.

VAN switch **520** provides multi-protocol object routing, depending upon the specific VAN services chosen. This multi-protocol object routing is provided via a proprietary protocol, TransWeb™ Management Protocol (TMP). TMP incorporates the same security features as the traditional Simple Network Management Protocol, SNMP. It also allows for the integration of other traditional security mechanisms, including RSA security mechanisms.

One embodiment of the present invention utilizes TMP and distributed on-line service information bases (DOLSIBs) to perform object routing. Alternatively, TMP can incorporate s-HTTP, Java™, the WinSock API or ORB with DOLSIBs to perform object routing. DOLSIBs are virtual information stores optimized for networking. All information entries and attributes in a DOLSIB virtual information store are associated with a networked object

8

identity. The networked object identity identifies the information entries and attributes in the DOLSIB as individual networked objects, and each networked object is assigned an Internet address. The Internet address is assigned based on the IP address of the node at which the networked object resides.

For example, in FIG. **5A**, Web server **104** is a node on the Internet, with an IP address. All networked object associated with Web server **104** will therefore be assigned an Internet address based on the Web server **104**'s IP address. These networked objects thus "branch" from the node, creating a hierarchical tree structure. The Internet address for each networked object in the tree essentially establishes the individual object as an "IP-reachable" or accessible node on the Internet. TMP utilizes this Internet address to uniquely identify and access the object from the DOLSIB. FIG. **6B** illustrates an example of this hierarchical addressing tree structure.

Each object in the DOLSIB has a name, a syntax and an encoding. The name is an administratively assigned object ID specifying an object type. The object type together with the object instance serves to uniquely identify a specific instantiation of the object. For example, if object **610** is information about models of cars, then one instance of that object would provide user **100** with information about a specific model of the car while another instance would provide information about a different model of the car. The syntax of an object type defines the abstract data structure corresponding to that object type. Encoding of objects defines how the object is represented by the object type syntax while being transmitted over the network.

C. Management and Administration

As described above, exchange **501** and management agent **601** together constitute a VAN switch. FIG. **7** illustrates conceptually the layered architecture of VAN switch **520**. Specifically, boundary service **701** provides the interfaces between VAN switch **520**, the Internet and the Web, and multi-media end user devices such as PCs, televisions or telephones. Boundary service **701** also provides the interface to the on-line service provider. A user can connect to a local application, namely one accessible via a local VAN switch, or be routed or "switched" to an application accessible via a remote VAN switch.

Switching service **702** is an OSI application layer switch. Switching service **702** thus represents the core of the VAN switch. It performs a number of tasks including the routing of user connections to remote VAN switches, described in the paragraph above, multiplexing and prioritization of requests, and flow control. Switching service **702** also facilitates open systems' connectivity with both the Internet (a public switched network) and private networks including back office networks, such as banking networks. Interconnected application layer switches form the application network backbone. These switches are one significant aspect of the present invention.

Management service **703** contains tools such as Information Management Services (IMS) and application Network Management Services (NMS). These tools are used by the end users to manage network resources, including VAN switches. Management service **703** also provides applications that perform Operations, Administration, Maintenance & Provisioning (OAM&P) functions. These OAM&P functions include security management, fault management, configuration management, performance management and billing management. Providing OAM&P functions for applications in this manner is another significant aspect of the present invention.

5,987,500

9

Finally, application service **704** contains application programs that deliver customer services. Application service **704** includes POSvc applications such as Bank POSvc described above, and illustrated in FIG. 6A. Other examples of VAN services include multi-media messaging, archival/ retrieval management, directory services, data staging, conferencing, financial services, home banking, risk management and a variety of other vertical services. Each VAN service is designed to meet a particular set of requirements related to performance, reliability, maintenance and ability to handle expected traffic volume. Depending on the type of service, the characteristics of the network elements will differ. VAN service **704** provides a number of functions including communications services for both management and end users of the network and control for the user over the user's environment.

FIG. 8 is a flow diagram illustrating one embodiment of the present invention. A user connects to a Web server running an exchange component in step **802**. In step **804**, the user issues a request for a transactional application, and the web server hands off the request to an exchange in step **806**. The exchange activates a graphical user interface to present user with a list of POSvc application options in step **808**. In step **810**, the user makes a selection from the POSvc application list. In step **812**, the switching component in the exchange switches the user to the selected POSvc application, and in step **814**, the object routing component executes the user's request. Data is retrieved from the appropriate data repository via TMP in step **816**, and finally, the user may optionally continue the transaction in step **818** or end the transaction.

Thus, a configurable value-added network switching and object routing method and apparatus is disclosed. These specific arrangements and methods described herein are merely illustrative of the principles of the present invention. Numerous modifications in form and detail may be made by those of ordinary skill in the art without departing from the scope of the present invention. Although this invention has been shown in relation to a particular preferred embodiment, it should not be considered so limited. Rather, the present invention is limited only by the scope of the appended claims.

We claim:

1. A configurable value-added network switch for enabling real-time transactions on a network, said configurable value-added network switch comprising:

means for switching to a transactional application in response to a user specification from a network application, said transactional application providing a user with a plurality of transactional services managed by at least one value-added network service provider, said value-added network service provider keeping a transaction flow captive, said plurality of transactional services being performed interactively and in real time;

means for transmitting a transaction request from said transactional application; and

means for processing said transaction request.

2. The configurable value-added network switch as claimed in claim 1 wherein said means for switching to a transactional application further comprises:

means for receiving said user specification;

means for enabling a switch to said transactional application; and

means for activating said transactional application.

3. The configurable value-added network switch as claimed in claim 2 wherein said means for activating said

10

transactional application further includes means for creating a transaction link between said network application and said transactional application.

4. The configurable value-added network switch as claimed in claim 2 wherein said means for receiving said user specification further comprises:

means for presenting said user with a list of transactional applications, each of said transactional application being associated with a particular value-added network service provider; and

means for submitting said user specification according to a user's selection of said transactional application from said list of transactional applications.

5. The configurable value-added network switch as claimed in claim 1 wherein said means for processing said transaction request further comprises means for coupling said means for transmitting to a host means.

6. The configurable value-added network switch as claimed in claim 5 wherein said host means contains data corresponding to said transaction request.

7. The configurable value-added network switch as claimed in claim 1 wherein said value-added network service providers cooperating to provide said plurality of transactional services to users.

8. The configurable value-added network switch as claimed in claim 1 further comprising means for controlling and prioritizing multiple transaction requests initiated by various users.

9. The configurable value-added network switch as claimed in claim 1 further comprising means for providing security management, fault management, configuration management, performance management and billing management.

10. A method for configuring a value-added network switch for enabling real-time transactions on a network, said method for configuring said value-added network switch comprising the steps of:

switching to a transactional application in response to a user specification from a network application, said transactional application providing a user with a plurality of transactional services managed by at least one value-added network service provider, said value-added network service provider keeping a transaction flow captive, said plurality of transactional services being performed interactively and in real time;

transmitting a transaction request from said transactional application; and processing said transaction request.

11. The method for configuring said value-added network switch as claimed in claim 10 wherein said step of switching to a transactional application further comprises the steps of:

receiving said user specification;

enabling a switch to said transactional application; and

activating said transactional application.

12. The method for configuring said value-added network switch as claimed in claim 11 wherein said step of activating said transactional application further includes a step of creating a transaction link between said network application and said transactional application.

13. The method for configuring said value-added network switch as claimed in claim 11 further comprising the steps of:

controlling security;

performing fault management;

providing configuration management;

managing performance; and

5,987,500

11

enabling billing management.

14. The method for configuring said value-added network switch as claimed in claim 11 wherein said step of receiving said user specification further comprises steps of:

presenting said user with a list of transactional applications, each of said transactional application being associated with a particular Internet service provider; and

submitting said user specification according to a user's selection of said transactional application from said list of transactional applications.

15. The method for configuring said value-added network switch as claimed in claim 10 wherein said step of processing said transaction request further comprises the step of transmitting said transaction request to a host means.

16. The method for configuring said value-added network switch as claimed in claim 15 wherein said host means contains data corresponding to said transaction request.

17. The method for configuring said value-added network switch as claimed in claim 10 wherein said value-added network service providers cooperate to provide said plurality of transactional services to said user.

18. The method for configuring said value-added network switch as claimed in claim 10 further comprising the step of controlling and prioritizing multiple transaction requests initiated by various users.

19. A method for enabling object routing on a network, said method for enabling object routing comprising the steps of:

associating an object identity with information entries and attributes, wherein the object identity represents a networked object;

storing said information entries and said attributes in a virtual information store; and

assigning a unique network address to said object identity.

20. The method in claim 19 wherein said step of associating said object identity with said information entries and said attributes in said virtual information store further includes the step of associating a name, a syntax and an encoding for said object identity.

21. The method in claim 20 wherein said name associated with said object identity specifies an object type.

22. The method in claim 21 wherein said object type and an object instance uniquely identify an instantiation of said object type.

23. The method in claim 22 wherein said syntax defines a data structure for said object type.

24. The method in claim 19 further comprising the step of utilizing said unique network address to identify and route said object identity on the network.

25. The method in claim 19 further comprising the step of utilizing said unique network address to identify and route said object identity on the Internet.

26. The method in claim 19 further comprising the step of utilizing said unique network address of said object identity

12

to perform Operations, Administration, Maintenance & Provisioning (OAM&P) functions.

27. An object router on a network, said object router comprising:

means for associating an object identity with information entries and attributes, wherein the object identity represents a networked object;

means for storing said information entries and said attributes in a virtual information store; and

means for assigning a unique network address to said object identity.

28. The object router in claim 27 wherein said means for associating said object identity with said information entries and said attributes in said virtual information store further includes means for associating a name, a syntax and an encoding for said object identity.

29. The object router in claim 28 wherein said name of said object identity specifies an object type.

30. The object router in claim 29 wherein said object type and an object instance uniquely identify an instantiation of said object type.

31. The object router in claim 30 wherein said syntax defines a data structure for said object type.

32. The object router in claim 27 further comprising means for utilizing said unique network address to identify and route said object identity on the network.

33. The object router in claim 27 further comprising means for utilizing said unique network address to identify and route said object identity on the Internet.

34. The object router in claim 27 further comprising the step of utilizing said unique network address of said object identity to perform Operations, Administration, Maintenance & Provisioning (OAM&P) functions.

35. A configurable value-added network system for enabling real-time transactions on a network, said configurable value-added network system comprising:

means for switching to a transactional application in response to a user specification from a network application, said transactional application providing a user with a plurality of transactional services managed by at least one value-added network service provider, said value-added network service provider keeping a transaction flow captive, said plurality of transactional services being performed interactively and in real time;

means for activating an agent to create a transaction link between said user application and said transactional application;

means for transmitting a transaction request from said transactional application; and

a host means for processing said transaction request and retrieving data corresponding to said transaction request.

* * * * *

EXHIBIT B



US008037158B2

(12) **United States Patent**
Arunachalam

(10) **Patent No.:** **US 8,037,158 B2**
(45) **Date of Patent:** **Oct. 11, 2011**

(54) **MULTIMEDIA TRANSACTIONAL SERVICES**

(76) Inventor: **Lakshmi Arunachalam**, Menlo Park, CA (US)

(*) Notice: Subject to any disclaimer, the term of this patent is extended or adjusted under 35 U.S.C. 154(b) by 184 days.

(21) Appl. No.: **11/980,185**

(22) Filed: **Oct. 30, 2007**

(65) **Prior Publication Data**

US 2008/0091801 A1 Apr. 17, 2008

Related U.S. Application Data

(60) Continuation-in-part of application No. 09/792,323, filed on Feb. 23, 2001, now Pat. No. 7,340,506, which is a continuation-in-part of application No. 08/879,958, filed on Jun. 20, 1997, now Pat. No. 5,987,500, which is a division of application No. 08/700,726, filed on Aug. 5, 1996, now Pat. No. 5,778,178.

(60) Provisional application No. 60/006,634, filed on Nov. 13, 1995.

(51) **Int. Cl.**
G06F 13/00 (2006.01)

(52) **U.S. Cl.** **709/219; 709/225; 709/229**

(58) **Field of Classification Search** **709/217, 709/219, 223, 225, 227, 229, 250; 719/328, 719/329**

See application file for complete search history.

(56) **References Cited**

U.S. PATENT DOCUMENTS

4,829,372 A 5/1989 McCalley et al.
4,851,988 A 7/1989 Trottier et al.
4,984,155 A 1/1991 Geier et al.

5,125,091 A 6/1992 Staas et al.
5,148,474 A 9/1992 Haralambopoulos et al.
5,159,632 A 10/1992 Crandall
5,231,566 A 7/1993 Blutinger et al.
5,239,662 A 8/1993 Danielson et al.
5,285,383 A 2/1994 Lindsey et al.
5,297,249 A 3/1994 Bernstein et al.
5,329,589 A 7/1994 Fraser et al.
5,329,619 A 7/1994 Page et al.
5,347,632 A 9/1994 Filepp et al.
5,367,635 A 11/1994 Bauer et al.
5,383,113 A 1/1995 Kight et al.
5,404,523 A 4/1995 DellaFera
5,408,619 A 4/1995 Oran
5,414,812 A 5/1995 Filip et al.
5,428,792 A 6/1995 Conner et al.
5,432,937 A 7/1995 Tevanian et al.

(Continued)

FOREIGN PATENT DOCUMENTS

WO 97/18515 A1 5/1997

(Continued)

OTHER PUBLICATIONS

Assign Inter Partes Reexam, Jan. 10, 2009, USPTO.

(Continued)

Primary Examiner — Viet Vu

(57) **ABSTRACT**

The present invention provides a method and apparatus for providing real-time, two-way transactional capabilities on the Web. Specifically, one embodiment of the present invention discloses a method for enabling object routing, the method comprising the steps of creating a virtual information store containing information entries and attributes associating each of the information entries and the attributes with an object identity, and assigning a unique network address to each of the object identities. A method is also disclosed for enabling service management of the value-added network service, to perform OAM&P functions on the services network.

11 Claims, 13 Drawing Sheets

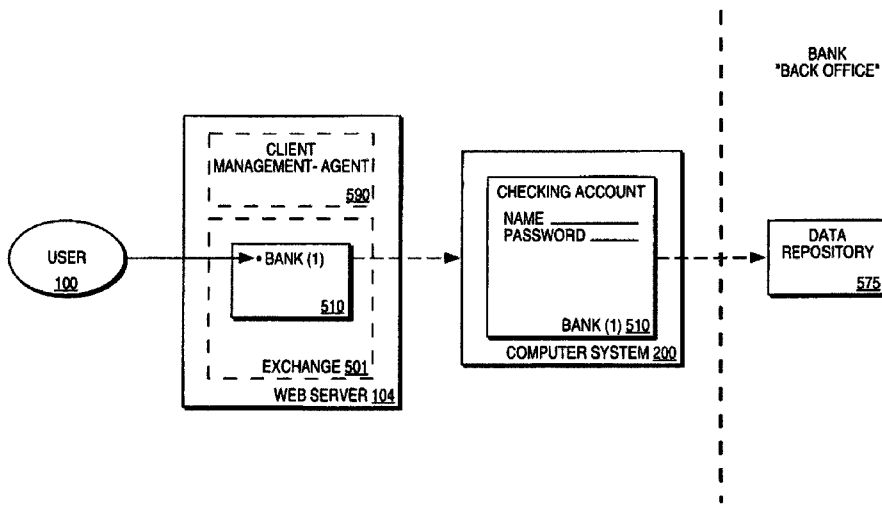

US 8,037,158 B2

Page 2

U.S. PATENT DOCUMENTS		
5,434,974 A	7/1995	Loucks et al.
5,440,744 A	8/1995	Jacobson et al.
5,442,771 A	8/1995	Filepp et al.
5,442,791 A	8/1995	Wrabetz et al.
5,444,192 A	8/1995	Shetye et al.
5,446,896 A	8/1995	Hegarty et al.
5,452,433 A	9/1995	Nihart et al.
5,455,903 A	10/1995	Jolissaint et al.
5,475,819 A	12/1995	Miller et al. 709/203
5,491,800 A	2/1996	Goldsmith et al.
5,517,645 A	5/1996	Stutz et al.
5,519,868 A	5/1996	Allen et al.
5,537,464 A	7/1996	Lewis et al.
5,539,909 A	7/1996	Tanaka et al.
5,557,780 A	9/1996	Edwards et al.
5,560,005 A	9/1996	Hoover et al.
5,577,251 A	11/1996	Hamilton et al.
5,590,197 A	12/1996	Chen
5,592,378 A	1/1997	Cameron et al.
5,604,905 A	2/1997	Tevanian et al.
5,613,148 A	3/1997	Bezviner et al.
5,664,111 A	9/1997	Nahan et al.
5,667,708 A	9/1997	Glass
5,671,279 A	9/1997	Elgamal
5,677,708 A	10/1997	Mathews et al.
5,694,549 A	12/1997	Carlin et al.
5,703,344 A	* 12/1997	Bezy et al. 235/379
5,706,442 A	1/1998	Anderson et al.
5,708,780 A	1/1998	Levergood et al.
5,710,887 A	1/1998	Chelliah et al.
5,712,913 A	1/1998	Chaum
5,715,314 A	2/1998	Payne et al.
5,715,444 A	2/1998	Danish et al.
5,724,424 A	3/1998	Gifford
5,742,762 A	4/1998	Scholl et al.
5,742,768 A	4/1998	Gennaro
5,745,681 A	4/1998	Levine et al.
5,754,939 A	5/1998	Herz et al.
5,757,917 A	5/1998	Rose et al.
5,758,072 A	5/1998	Filepp et al.
5,758,327 A	5/1998	Gardner et al.
5,771,354 A	6/1998	Crawford
5,774,670 A	* 6/1998	Montulli 709/227
5,778,178 A	7/1998	Arunachalam
5,780,780 A	7/1998	Ahmed
5,781,631 A	7/1998	Chaum
5,793,964 A	* 8/1998	Rogers et al. 709/202
5,794,221 A	8/1998	Egendorf
5,794,234 A	8/1998	Church et al.
5,809,483 A	9/1998	Broka et al.
5,812,779 A	9/1998	Ciscon et al.
5,822,569 A	10/1998	McPartlan et al.
5,826,085 A	10/1998	Bennett et al.
5,826,241 A	10/1998	Stein et al.
5,828,666 A	10/1998	Focsaneanu et al.
5,835,726 A	11/1998	Shwed
5,845,061 A	12/1998	Miyamoto et al.
5,845,073 A	12/1998	Carlin et al.
5,845,265 A	12/1998	Woolston
5,856,974 A	1/1999	Gervais et al.
5,859,978 A	1/1999	Sonderegger et al. 709/226
5,864,866 A	1/1999	Henckel et al.
5,870,473 A	2/1999	Boesch et al.
5,870,724 A	2/1999	Lawlor et al.
5,873,072 A	2/1999	Kight et al.
5,873,093 A	2/1999	Williamson et al.
5,878,140 A	3/1999	Chaum
5,878,141 A	3/1999	Daly et al.
5,878,403 A	3/1999	DeFrancesco et al.
5,884,301 A	3/1999	Takano
5,889,957 A	3/1999	Ratner et al.
5,890,137 A	3/1999	Koreeda
5,890,161 A	3/1999	Helland et al.
5,892,821 A	4/1999	Turner
5,893,076 A	4/1999	Hafner et al.
5,895,454 A	4/1999	Harrington
5,897,621 A	4/1999	Boesch et al.
5,901,228 A	5/1999	Crawford
5,909,492 A	6/1999	Payne et al.
5,910,987 A	6/1999	Ginter et al.
5,913,061 A	6/1999	Gupta et al.
5,931,967 A	8/1999	Shimizu et al.
5,956,400 A	9/1999	Chaum et al.
5,956,509 A	9/1999	Kevner
5,958,004 A	9/1999	Helland et al.
5,960,411 A	9/1999	Hartman et al.
5,987,500 A	11/1999	Arunachalam
6,003,085 A	12/1999	Ratner et al.
6,014,651 A	1/2000	Crawford
6,014,666 A	1/2000	Helland et al.
6,049,785 A	4/2000	Gifford
6,049,819 A	4/2000	Buckle et al.
6,055,514 A	4/2000	Wren
6,055,567 A	4/2000	Ganesan et al.
6,073,237 A	6/2000	Ellison
6,092,053 A	7/2000	Boesch et al.
6,094,673 A	7/2000	Dilip et al.
6,101,482 A	8/2000	DiAngelo et al.
6,101,527 A	8/2000	Lejeune et al.
6,119,152 A	9/2000	Carlin et al.
6,125,185 A	9/2000	Boesch
6,125,352 A	9/2000	Franklin et al.
6,128,315 A	10/2000	Takeuchi
6,134,594 A	10/2000	Helland et al.
6,135,646 A	10/2000	Kahn et al.
6,145,090 A	11/2000	Yamaguchi et al.
6,185,609 B1	2/2001	Rangarajan et al.
6,192,250 B1	2/2001	Buskens et al.
6,205,433 B1	3/2001	Boesch et al.
6,212,556 B1	4/2001	Arunachalam
6,212,634 B1	4/2001	Gerr, Jr. et al.
6,249,291 B1 *	6/2001	Popp et al. 345/473
6,279,001 B1 *	8/2001	DeBettencourt et al. 1/1
6,289,322 B1	9/2001	Kitchen et al.
6,295,522 B1	9/2001	Boesch
6,301,601 B1	10/2001	Helland et al.
6,327,577 B1	12/2001	Garrison et al.
6,327,579 B1	12/2001	Crawford
6,334,116 B1	12/2001	Ganesan et al.
6,360,262 B1	3/2002	Guenther et al.
6,363,362 B1	3/2002	Burfield et al.
6,411,943 B1	6/2002	Crawford
6,453,426 B1	9/2002	Gamache et al.
6,457,066 B1	9/2002	Mein et al.
6,473,740 B2	10/2002	Cockrill et al.
6,473,791 B1	10/2002	Al-Ghosein et al.
6,486,895 B1 *	11/2002	Robertson et al. 715/776
6,490,567 B1	12/2002	Gregory
6,553,427 B1	4/2003	Chang et al.
6,574,607 B1	6/2003	Carter et al.
6,625,581 B1	9/2003	Perkowski
6,678,664 B1	1/2004	Ganesan
6,678,696 B1	1/2004	Helland et al.
6,714,962 B1	3/2004	Helland
6,839,677 B2	1/2005	Mathur et al.
6,850,996 B2	2/2005	Wagner
6,856,974 B1	2/2005	Ganesan et al.
6,931,111 B1	8/2005	Coffee
6,932,268 B1	8/2005	McCoy et al.
6,948,063 B1	9/2005	Ganesan et al.
7,076,784 B1	7/2006	Russell et al.
7,080,051 B1	7/2006	Crawford
7,107,244 B2	9/2006	Kight et al.
7,120,602 B2	10/2006	Kitchen et al.
7,146,338 B2	12/2006	Kight et al.
7,175,074 B2	2/2007	Mejias et al.
7,177,846 B2	2/2007	Moenickeheim et al.
7,213,003 B1	5/2007	Kight et al.
7,240,031 B1	7/2007	Kight et al.
7,251,656 B2	7/2007	Keown et al.
7,296,004 B1	11/2007	Garrison et al.
7,302,408 B2	11/2007	Engdahl et al.
7,302,411 B2	11/2007	Ganesan et al.
7,330,831 B2	2/2008	Biondi et al.
7,334,128 B2	2/2008	Ganesan et al.
7,340,506 B2	3/2008	Arunachalam
7,366,696 B1	4/2008	Ganesan et al.

US 8,037,158 B2

Page 3

7,366,697	B2	4/2008	Kitchen et al.
7,383,226	B2	6/2008	Kight et al.
7,389,514	B2	6/2008	Russell et al.
7,392,223	B1	6/2008	Ganesan et al.
7,395,243	B1	7/2008	Zielke et al.
7,395,319	B2	7/2008	Harris et al.
7,451,400	B2	11/2008	Bales
7,590,550	B2	9/2009	Schoenberg
7,600,027	B2	10/2009	Yan
2001/0037318	A1	11/2001	Lindskog
2002/0062218	A1	5/2002	Pianin
2002/0152200	A1	10/2002	Krichilsky et al.
2003/0069922	A1	4/2003	Arunachalam
2008/0091801	A1	4/2008	Arunachalam
2009/0094347	A1	4/2009	Ting

FOREIGN PATENT DOCUMENTS

WO	WO 97/18515	5/1997
WO	00/63781 A1	10/2000

OTHER PUBLICATIONS

Req Inter Partes Reexam, Dec. 19, 2009, Microsoft Corp.
 Appendices A-C Related interpartes reexam U.S. Appl. No. 95/001,129, Dec. 19, 200.
 Part of U.S. Appl. No. 08/168,519 file Ex. 5, U.S. Appl. No. 95/001,129, Dec. 16, 1993.
 A Cobra Based Framework—Arshad et al 1999.
 Generic Mgt Info Base Browser—Pavlou et al.
 Hetro Distrib Info System—Chung et al 1995.
 Agent Based System—Internet Based—Ehikioya 1999.
 Broadvision 1-1 Dev. Guide—1995 Contents Only—vii.
 Broadvision—PGM Ref 1995 pp. 4-5, 21, 30, 973
 Broadvision—Tech Overview 1995 pp. 1-3.
 Database Access Intel-Networks—Raatykainen P-1.
 802.3 Repeater Devices 1992 pp. 1-3.
 ERP Meets Web E-Commerce 1998 P-1.
 Microsoft Transaction Server—Limprecht 1997.
 Netbill—Protocol P-1 Tygar.
 OBJ Oriented—Hyper G-MSWindows—Contents & p. 3.
 Dialog Web—M. Hickey 1994 P-1.
 Transaction Internet Protocol—Vogler et al. 1999.
 RFC 1065, 1988, Network Working Group.
 RFC 1318, 1992, Network Working Group.
 RFC 1283, 1991, Network Working Group.
 RFC 1516, 1993, Network Working Group.
 Lamond, Keith, “Credit Card Transactions Real World and Online” http://www.virtualshcool.edu/mon/ElectronProperty/klamond/credit_card/htm, pp. 1-16, 1996.
 Cox, Benjamin et al., “Netbill Security and Transaction Protocol”, Carnegie Millon University, Pittsburgh, PA 15212-3890.
 “Tymnet”, Wikipedia, the free encyclopedia, <http://en.wikipedia.org/wiki/tymnet>, May 2007.
 Hickey, “Shopping at Home: One Modem Line, No Waiting”, Home PC, Dec. 1, 1994, p. 307, Dialog, File 647, Acc# 01038162.
 Lang, “Cashing in: The Rush is on to Buy and Sell on the Internet but Conflicting Schemes Leave Marketers on Sidelines for Now”, Advertising Age, Dec. 19, 1994, p. 11, Dialog File 16, Acc# 05419137.
 Banks, Michael A., “America Online: A Graphics-based Success”, Link-Up, Jan./Feb. 1992.
 “Hot Java”, Wikipeda, the free encyclopediia, <http://en.wikipedia.org/wiki/HotJava>, May 2007.
 Lichty, Tom, “America Online tour Guide”, MacIntosh Edition, Version 2, Preface, Chapter 1, Ventanna Press, 1992.
 Lichty, Tom, “America Online tour Guide”, MacIntosh Edition, Version 2, Preface, Chapter 3, Ventanna Press, 1992.
 Lichty, Tom, “America Online tour Guide”, MacIntosh Edition, Version 2, Preface, Chapter 8, Ventanna Press, 1992.
 Lichty, Tom, “America Online tour Guide”, MacIntosh Edition, Version 2, Preface, Chapter 10, Ventanna Press, 1992.
 Broadvision One-to-One Developer’s Guide, p. vii.
 Broadvision One-to-One Installation & System AdminGuide.
 Broadvision One-to-One Technical Overview, pp. 1-3.
 Broadvision One-to-One Dynamic Command CTR User’S Guide.
 Prodigy Made East 2nd Ed.
 Computer Networks—Sys Approach Peterson & Davie.
 Untangling the World-Wide-Web Relihan, Cahill & Hinchey.
 The Simple Book—An Intro to Internet Management.
 Google Groups Comp. Doc—RFC’s 1212 1213 on Concise Definitions MIB and MIB II.
 Small Talk Object Model <http://www.objs.com/x3h7/smalltalk.htm>.
 A Protocol&Server for a Distrib—Digital Tech Report Library.
 Distributed Applications in a Hypermedia Setting—Bharat & Gardelli.
 Dienst: Implementation Ref Manual Lagoze, Shaw, Davis & Krafft.
 Object Wrapping for (www/Edwards, 1995).
 Understanding DCE Chaps 1-3 DCE—The Network as Computer Etc.
 Visual Obliq—JXI for Bldg Distrib Multi-User Apps by Direct Manipulation Bharat & Brown.
 Using the Web as a Survey Tool Pitkow & Recker.
 Compuserve for Windows Banks.
 Distributed Object Technology in Financial Service Industry Sun Microsystems.
 Businesswire—Open Market Releases.
 Distributed Computing—A Practical Synthesis—UMAR.
 Orbix—Programmer’s Guide Iona Technologies Ltd.
 Travel Services—Join Compuserve & See the World, 1987.
 Order Granting Defendant’s Motion to Dismiss—Northern District of California Feb. 17, 2009.
 Microsoft Corporation’s Notice of Motion and Motion for Leave to Amend (Complaint) US District Court—Northern District of California.
 Dr. Gui on Components, COM, and ATL Part I: You’re Gonna Do Com?, , Feb. 2, 1998, <http://msdn.microsoft.com/library/welcome/dsmsdn/msdn-drguion020298.htm>, Part 2: Basics of COM, Feb. 9, 1998, <http://msdn.microsoft.com/library/welcome/dsmsdn/msdn-drguion020298.htm>, Part 3: Getting Objects and Interfaces, Feb. 23, 1998, <http://msdn.microsoft.com/library/welcome/dsmsdn/msdn-drguion020298.htm>, Part 4: The Class Object and Class Factory, Mar. 2, 1998, <http://msdn.microsoft.com/library/welcome/dsmsdn/msdn-drguion020298.htm>, Part 5: Implementing an Object, Mar. 30, 1998, <http://msdn.microsoft.com/library/welcome/dsmsdn/msdn-drguion020298.htm>, Part 6: Using our COM Object in Visual Basic . . . , Apr. 27, 1998, <http://msdn.microsoft.com/library/welcome/dsmsdn/msdn-drguion020298.htm>, Part 7: Using our Object from Visual C++, May 29, 1998, <http://msdn.microsoft.com/library/welcome/dsmsdn/msdn-drguion020298.htm>, Part 8: Get Smart! Using our COM Object . . . , Jul. 30, 1998 <http://msdn.microsoft.com/library/welcome/dsmsdn/msdn-drguion020298.htm>.
 Microsoftcom.news Dr. GUI’s Gentle Guide to COM, Nov. 1, 1999, <http://www.microsoft.com/Com/news/drgui.asp>.
 Taking the Splash Diving into ISAPI Programming, Jan. 1997, Christian Gross <http://www.microsoft.com/mind/0197/isapi.htm>.
 Chapter 1, NSAPI Basics, Dec. 22, 1997, <http://developer.netscape.com/docs/manuals/enterprise/nsapi/svrop.htm>.
 The Common Gateway Interface, retrieved May 22, 2001, <http://hoohoanesa.uinc.edu/cgi/primer.html>.
 Open Market Content—Driven eBusiness Solutions, Retrieved May 15, 2001, <http://www.openmarket.com/cgi-bin/gx.cgi/AppLogic+ETContentServer?pagename=FutureTense/Apps/Xcelerate/View6c=Collec...>
 OpenMarket Content Server, May 15, 2001, <http://www.openmarket.com/cgi-bin/gx.cgi/AppLogic+FTContentServer&pagename=FutureTense/Apps/xcelerate/Render&C=Artic....>
 Open Market Content Centre, Retrieved May 15, 2001, <http://www.openmarket.com/cgi-bin/gx.cgi/AppLogic+FTContentServer&pagename=FutureTense/Apps/xcelerate/Render&C=Artic....>
 OpenMarket Integration Centre, May 15, 2001, <http://www.openmarket.com/cgi-bin/gx.cgi/AppLogic+FTContentServer&pagename=FutureTense/Apps/xcelerate/Render&C=Artic....>
 OpenMarket Personalization Centre, May 15, 2001, <http://www.openmarket.com/cgi-bin/gx.cgi/AppLogic+FTContentServer&pagename=FutureTense/Apps/xcelerate/Render&C=Artic....>
 OpenMarket Catalog Centre, May 15, 2001, <http://www.openmarket.com/cgi-bin/gx.cgi/AppLogic+FTContentServer&pagename=FutureTense/Apps/xcelerate/Render&C=Artic....>

US 8,037,158 B2

Page 4

OpenMarket Marketing Studio, May 15, 2001, [http://www.openmarket.com/cgi-bin/gx.cgi/AppLogic+FTContentServer & pagename=FutureTense/Apps/xcelerate/Render&C=Artic...](http://www.openmarket.com/cgi-bin/gx.cgi/AppLogic+FTContentServer&pagename=FutureTense/Apps/xcelerate/Render&C=Artic...)

OpenMarket Satellite Server, May 15, 2001, [http://www.openmarket.com/cgi-bin/gx.cgi/AppLogic+FTContentServer & pagename=FutureTense/Apps/xcelerate/Render&C=Artic...](http://www.openmarket.com/cgi-bin/gx.cgi/AppLogic+FTContentServer&pagename=FutureTense/Apps/xcelerate/Render&C=Artic...)

OpenMarket Commerce Products, Retrieved May 15, 2001, <http://www.openmarket.com/cgi-bin/gx.cgi/Apologic+FTContentServer?pagename=FutureTense/Apps/xcelerate/...>

OpenMarket Transact, May 15, 2001, <http://www.openmarket.com/cgi-bin/gx.cgi/Apologic+FTContentServer?pagename=FutureTense/Apps/xcelerate/...>

OpenMarket Shopsite, May 15, 2001, <http://www.openmarket.com/cgi-bin/gx.cgi/Apologic+FTContentServer?pagename=FutureTense/Apps/xcelerate/...>

OpenMarket Open Exchange Shopsite 5.0, May 15, 2001, <http://www.openmarket.com/cgi-bin/gx.cgi/Apologic+FTContentServer?pagename=FutureTense/Apps/xcelerate/...>

OpenMarket Wireless Solutions, an OpenMarket eBusiness Solution Brief, Feb. 13, 2001, <http://www.openmarket.com/>.

OpenMarket Portal Solutions an OpenMarket eBusiness Solution Brief, Feb. 21, 2001, <http://www.openmarket.com/>.

CyberCash Inc.—The E-Commerce Lender in Payment Solutions—B2B, 1996 Retrieved May 23, 2001, <http://www.cybercash.com/>.

CyberCash Products, May 23, 2001, <http://www.cybercash.com/products/>.

CyberCash Cash & Register—Online Secure Payment Service, May 23, 2001, <http://www.cybercash.com/cashregister/>.

Cybercash ICverify 2.5 Upgrade, May 23, 2001, <http://www.cybercash.com/icverify/upgrade.html>.

Cybercash Cash Register—How It Works, Retrieved May 23, 2001, <http://www.cybercash.com/cashregister/howitworks.html>.

Cybercash Cash Register—Industry Leading Features, May 23, 2001, <http://www.cybercash.com/cashregister/features.html>.

Cybercash Cash Register—Why Choose Cash Register?, May 23, 2001, <http://www.cybercash.com/cashregister/why.html>.

Cybercash Cash Register—Online Secure Payment Service, 2000, <http://webdata.cybercash.com/demos/>.

Cybercash Web Authorize—Enterprise and Hosting Payment Processing, Retrieved May 23, 2001, <http://www.cybercash.com/webauthorize/>.

Cybercash B2B Payment Services, Retrieved May 23, 2001, <http://www.cybercash.com/b2b/>.

Cybercash Fraud Patrol Service, May 23, 2001, <http://www.cybercash.com/fraudpatrol/>.

Cybercash PC Authorize—Payment Software for Back-and-Mortar Merchants, May 23, 2001, <http://www.cybercash.com/pcauthorize/>.

Microsoft Component Services—Server Operating System—A Technology Overview, Dated Aug. 15, 1998 Retrieved May 22, 2001, <http://www.microsoft.com/com/wpaper/comsvcs.asp>.

iPIN Home, Retrieved May 23, 2001, <http://www.ipin.com/>.

iPIN Company Info, Retrieved May 23, 2001, <http://www.ipin.com/01comp.html>.

iPIN Products—The iPIN Approach, Retrieved May 23, 2001, <http://www.ipin.com/02prod.html>.

iPIN Products—Technology, Retrieved May 23, 2001, http://www.ipin.com/02prod_tech.html.

iPIN Products—Solutions, Retrieved May 23, 2001, http://www.ipin.com/02prod_solution.html.

iPIN Products—Service Options, Retrieved May 23, 2001, http://www.ipin.com/02prod_service.html.

iPIN Partners, Retrieved May 23, 2001, <http://www.ipin.com/03part.html>.

Cybercash Fraud Patrol How It Works, Retrieved May 23, 2001, <http://www.cybercash.com/fraudpatrol/howitworks.html>.

Posting of Joyce Reynolds to Comp. Doc. Usenet (Mar. 27, 1991). Sample Book: An Intro to Internet Management pp. 14-15, pp. 379-387 (2nd ed 1994).

Managing Internetworks with SNMP Miller pp. 138-139 (1993).

“Untangling the World Wide Web” Relihan, Cahil, Hinchin (Oct. 1994).

RFC 1155, May 1990, Network Working Group.

RFC 1157, May 1990, Network Working Group.

RFC 1213, Mar. 1991, Network Working Group.

RFC 1447, Apr. 1993, Network Working Group.

RFC 1156, May 1990, Network Working Group.

Request for Reexamination for Patent 5,778,178, Nov. 28, 2008.

U.S. Appl. No. 60/208,057, filed May 31, 2000, Krichilsky.

Complaint for Declaratory Judgment of Patent Non/Infringement, Invalidation, and Unenforceability; (Dated Jul. 2, 2009) (219 pages).

Defendant Webxchange Inc.’S Motion to Dismiss Microsoft’s Complaint With Prejudice for Lack of Subject-Matter Jurisdiction, and for Attorneys’ Fees (entered Aug. 26, 2009).

Microsoft’s Opposition to WebXchange, Inc.’s Motion to Dismiss Microsoft’s Complaint (dated Sep. 14, 2009).

Order Dismissing Microsoft (Oct. 30, 2009) Judge Alsup.

Memorandum Opinion Microsoft (Oct. 30, 2009) Judge Farnan.

Complaint filed with Jury Demand against Allstate Corporation, Allstate Insurance Company, Allstate Life Insurance Company, Allstate Financial Services LLC, Allstate Financial LLC—.(Filing fee \$ 350, receipt No. 0311000000000419775.)—filed by WebXchange Inc.. (Attachments: # 1 Exhibit A, # 2 Exhibit B, # 3 Exhibit C, # 4 Civil Cover Sheet)(lid) (Entered: Mar. 5, 2008).

Answer to 1 Complaint, with Jury Demand, Counterclaim against WebXchange Inc. by Allstate Corporation, Allstate Insurance Company, Allstate Life Insurance Company, Allstate Financial Services LLC, Allstate Financial LLC. (McGeever, Elizabeth) (Entered: Apr. 25, 2008).

Answer to 15 Answer to Complaint, Counterclaim Plaintiff WebXchange Inc.’s Answer to Defendant Allstate’s Counterclaims by WebXchange Inc..(Heaney, Julia) (Entered: May 19, 2008).

Claim Construction Opening Brief [Defendants’ Opening Brief in Support of Their Proposed Claim Constructions] filed by Allstate Insurance Company, Allstate Life Insurance Company, Allstate Financial Services LLC. (Moore, David) (Entered: Oct. 29, 2008).

Claim Construction Opening Brief filed by WebXchange Inc.. (Attachments: # 1 Exhibits A-B)(Heaney, Julia) (Entered: Oct. 29, 2008).

First Amended Answer, Affirmative Defenses, and Counterclaims to 1 Complaint by Allstate Corporation, Allstate Insurance Company, Allstate Life Insurance Company, Allstate Financial Services LLC, Allstate Financial LLC. (nms) (nms). (Entered: Jan. 14, 2009), (Three Parts).

Answer to 90 Amended Answer to Complaint, Counterclaim by WebXchange Inc..(Heaney, Julia) (Entered: Feb. 2, 2009).

Motion to Bifurcate and for Early Trial on the Issue of Inequitable Conduct—filed by FedEx Corporation, FedEx Kinko’s Office & Print Services, Inc., FedEx Corporate Services Inc.. (Gaza, Anne) Modified on Mar. 23, 2009 (nms). (Entered: Mar. 19, 2009).

Notice of Motion re 107 Motion to Bifurcate and for Early Trial on the Issue of Inequitable Conduct; Request the following Motion Day: Apr. 17, 2009 (Gaza, Anne) Modified on Mar. 23, 2009 (nms). (Entered: Mar. 19, 2009).

7.1.1 Statement re 107 Motion to Bifurcate and for Early Trial on the Issue of Inequitable Conduct by FedEx Corporation, FedEx Kinko’s Office & Print Services, Inc., FedEx Corporate Services Inc.. (Gaza, Anne) Modified on Mar. 23, 2009 (nms). (Entered: Mar. 19, 2009).

Redacted Version of 110 Opening Brief in Support, , by FedEx Corporation, FedEx Kinko’s Office & Print Services, Inc., FedEx Corporate Services Inc.. (Attachments: # 1 Exhibit 1, # 2 Exhibit 2, # 3 Exhibit 3, # 4 Exhibit 4, # 5 Exhibit 5, # 6 Exhibit 6, # 7 Exhibit 7, # 8 Exhibit 8, # 9 Exhibit 9, # 10 Exhibit 10, # 11 Exhibit 11, # 12 Exhibit 12, # 13 Exhibit 13)(Gaza, Anne) (Entered: Mar. 23, 2009), (Four Parts).

Claim Construction Opening Brief Defendants’ Opening Brief in Support of Their Proposed Claim Constructions filed by Allstate Insurance Company, Allstate Life Insurance Company, Allstate Financial Services LLC. (McGeever, Elizabeth) (Entered: Mar. 23, 2009).

US 8,037,158 B2

Page 5

Claim Construction Opening Brief filed by WebXchange Inc.. (Attachments: # 1 Exhibits A-B)(Heaney, Julia) (Additional attachment(s) added on Mar. 25, 2009: # 2 Main Document) (nms). (Entered: Mar. 23, 2009), (Two Parts).

Plaintiff Webxchange Inc.'s Corrected Answering Brief in Opposition to Defendants' Motion to Bifurcate, and for Early Trial on, the Issue of Inequitable Conduct /// Certificate of Service I, the undersigned, hereby certify that on May 13, 2009, I electronically filed the foregoing with the Clerk of the Court using CM/ECF, which will send notification of such filing(s) to the following: /// Certificate of Service I, the undersigned, hereby certify that on May 13, 2009, I electronically filed the foregoing with the Clerk of the Court using CM/ECF, which will send notification of such filing(s) to the following: /// Julia Heaney.

"Declaration of Eric 3. Stieglitz in Support Ofplaintiff Webxchange Inc.'S Answering Brief in Oppositionto Defendants' Motion to Bifurcate, and for Early Trial on,the Issue of Inequitable Conduct // Redacted—Public Version / signed Apr. 27, 2009Certificate of Servicei, the undersigned, hereby certify that on May 13, 2009, I electronically filed the foregoing with the Clerk of the Court using CM/ECF, which will send notification of such filing(s) to the following: (Two Parts)" Julia Heaney.

Case 1:08-cv-00131-JJF Document 142 Filed Jun. 1, 2009 p. 1 of 19 // Reply Brief in Support of Defendants' Motion to Bifurcate, and 11011 Early Trial on, the Issue of Inequitable Conduct /// Redacted Public Version /// Certificate of Service I hereby certify that on Jun. 1, 2009, I caused to be served by electronic mail the foregoing document and electronically filed the same with the Cleric of Court using CM/ECF which will send notification of such filing(s) to the following: Exhibits A-W to Redacted Reply Brief.

"Case 1:08-cv-00131-JJF Document 146 Filed Jun. 18, 2009 p. 1 of 5 // Motion for Leave to Amend Answer,Affirmative Defenses, and Counterclaims // Filed: Jun. 18, 2009".

"Defendants' Opening Brief in Support of Its Motion for Leave Toamend Answer, Affirmative Defenses, and Counterclaims // Case 1:08-cv-00131-JJF, Filed Jun. 18, 2009 p. 1 of 12".

Plaintiff Webxchange Inc.'s Answering Brief in Opposition to Allstate's Second Motion for Leave to Amend its Answer, C.A. No. 08-131 (JJF).

Complaint filed with Jury Demand against Dell Inc. -. (Filing fee \$ 350, receipt No. 0311000000000419782.)—filed by WebXchange Inc.. (Attachments: # Exhibit A, # 2 Exhibit B, # 3 Exhibit C, # 4 Civil Cover Sheet)(lid) (Entered: Mar. 5, 2008).

Answer to 1 Complaint with Jury Demand, Counterclaim [Dell Inc.'s Answer, Defenses and Counterclaims to Webxchange Inc.'s Complaint for Patent Infringement] against Dell Inc. by Dell Inc.. (Horwitz, Richard) (Entered: Mar. 26, 2008).

Answer to 8 Answer to Complaint, Counterclaim Plaintiff WebXchange Inc.'s Answer to Defendant Dell's Counterclaims by WebXchange Inc..(Heaney, Julia) (Entered: Apr. 18, 2008).

Claim Construction Opening Brief [Defendants' Opening Brief in Support of Their Proposed Claim Constructions] filed by Dell Inc.. (Moore, David) (Entered: Oct. 29, 2008).

Claim Construction Opening Brief filed by WebXchange Inc.. (Attachments: # 1 Exhibits A-B)(Heaney, Julia) (Entered: Oct. 29, 2008).

Reply Brief re 37 Motion for Discovery filed by Dell Inc.. (Attachments: # 1 Exhibit A-L, # 2 Exhibit M-S)(Gaza, Anne) (Entered: Oct. 31, 2008).

Motion to Amend/Correct Answer and Counterclaims to Complaint (Unopposed)—filed by Dell Inc.. (Attachments: # 1 Notice of Motion, # 2 Text of Proposed Order, # 3 Exhibit A (First Amended Answer), # 4 Exhibit B (Blackline of First Amended Answer))(Moore, David) Modified on Jan. 13, 2009 (nms). (Entered: Jan. 12, 2009).

Order Granting 72 Defendant Dell Inc.'s Unopposed Motion to Amend its Answer and Counterclaims to Webexchange Inc.'s Original Complaint for Patent Infringement. Signed by Judge Joseph J. Farnan, Jr. on Jan. 13, 2009. (nms) (Entered: Jan. 14, 2009).

Dell Inc.'s First Amended Answer and Counterclaims to 1 Complaint by Dell Inc.. (nms) (Entered: Jan. 14, 2009).

Answer to 75 Amended Answer to Complaint, Counterclaim by WebXchange Inc..(Heaney, Julia) (Entered: Feb. 2, 2009).

Motion to Bifurcate and for Early Trial on, the Issue of Inequitable Conduct—filed by FedEx Corporation, FedEx Kinko's Office & Print Services, Inc., FedEx Corporate Services Inc.. (Gaza, Anne) Modified on Mar. 23, 2009 (nms). (Entered: Mar. 19, 2009).

Notice of Motion re 85 Motion to Bifurcate and for Early Trial on the Issue of Inequitable Conduct; Requesting the following Motion Day: Apr. 17, 2009 (Gaza, Anne) Modified on Mar. 23, 2009 (nms). (Entered: Mar. 19, 2009).

7.1.1 Statement re 85 Motion to Bifurcate and for Early Trial on the Issue of Inequitable Conduct by FedEx Corporation, FedEx Kinko's Office & Print Services, Inc., FedEx Corporate Services Inc.. (Gaza, Anne) Modified on Mar. 23, 2009 (nms). (Entered: Mar. 19, 2009).

Redacted Version of 88 Opening Brief in Support, , by FedEx Corporation, FedEx Kinko's Office & Print Services, Inc., FedEx Corporate Services Inc.. (Attachments: # 1 Exhibit 1, # 2 Exhibit 2, # 3 Exhibit 3, # 4 Exhibit 4, # 5 Exhibit 5, # 6 Exhibit 6, # 7 Exhibit 7, # 8 Exhibit 8, # 9 Exhibit 9, # 10 Exhibit 10, # 11 Exhibit 11, # 12 Exhibit 12, # 13 Exhibit 13)(Gaza, Anne) (Entered: Mar. 23, 2009), (Three Parts).

Claim Construction Opening Brief Defendants' Opening in Support of Their Proposed Claim Constructions filed by Dell Inc.. (McGeever, Elizabeth) (Entered: Mar. 23, 2009).

Claim Construction Opening Brief filed by WebXchange Inc.. (Attachments: # 1 Exhibits A-B)(Heaney, Julia) (Additional attachment(s) added on Mar. 25, 2009: # 2 Main Document) (nms). (Entered: Mar. 23, 2009), (Two parts).

Defendant Dell Inc.'s Motion for Leave to Amend Its Answer (to file a Second Amended Answer); Jury Trial Demanded (entered Jul. 23, 2009).

Plaintiff WebXchanges Inc.'s Answering Brief in Opposition to Dell's Second Motion for Leave to Amend its Answer (entered Aug. 10, 2009).

Defendant Dell Inc.'s Opening Brief in Support of Its Motion for Leave to Amend Answer (entered Aug. 11, 2009).

Declaration of Charlotte Pontillo in Support of WebXchange Inc.'s Answering Brief in Opposition to Dell's Second Motion for Leave to Amend its Answer; (entered Aug. 12, 2009).

Defendant Dell Inc.'s Reply Brief in Support of Its Motion for Leave to Amend Answer (entered Aug. 20, 2009).

Order, Judge Stark.

Complaint filed with Jury Demand against FedEx Corporation, FedEx Kinko's Office & Print Services Inc., FedEx Corporate Services Inc. -. (Filing fee \$ 350, receipt No. 0311000000000419793.)—filed by WebXchange Inc.. (Attachments: # 1 Exhibit A, # 2 Exhibit B, # 3 Exhibit C, # 4 Civil Cover Sheet)(lid) (Entered: Mar. 5, 2008).

Answer to 1 Complaint, with Jury Demand, Counterclaim against WebXchange Inc. by FedEx Corporation, FedEx Kinko's Office & Print Services Inc., FedEx Corporate Services Inc..(Gaza, Anne) (Entered: Apr. 25, 2008).

Answer to 13 Answer to Complaint, Counterclaim Plaintiff WebXchange Inc.'s Answer to Defendant FedEx's Counterclaims by WebXchange Inc..(Heaney, Julia) (Entered: May 19, 2008).

Claim Construction Opening Brief [Defendants' Opening Brief in Support of Their Proposed Claim Constructions] filed by FedEx Corporation, FedEx Kinko's Office & Print Services Inc., FedEx Corporate Services Inc.. (Moore, David) (Entered: Oct. 29, 2008).

Claim Construction Opening Brief filed by WebXchange Inc.. (Attachments: # 1 Exhibits A-B)(Heaney, Julia) (Entered: Oct. 29, 2008).

Motion to Amend/Correct 13 Answer to Complaint, Counterclaim—filed by FedEx Corporation, FedEx Kinko's Office & Print Services Inc., FedEx Corporate Services Inc.. (Attachments: # 1 Exhibit A, # 2 Exhibit B, # 3 Exhibit C)(Gaza, Anne) (Entered: Jan. 12, 2009).

Notice of Motion by FedEx Corporation, FedEx Kinko's Office & Print Services Inc., FedEx Corporate Services Inc. re 89 Motion to Amend/Correct 13 Answer to Complaint, Counterclaim Motion to Amend/Correct 13 Answer to Complaint, Counterclaim ; Requesting the following Motion Day; Feb. 19, 2009 (Gaza, Anne) (Entered: Jan. 12, 2009).

Sealed Opening Brief in Support re 89 Motion to Amend/Correct 13 Answer to Complaint, Counterclaim Motion to Amend/Correct 13 Answer to Complaint, Counterclaim filed by FedEx Corporation,

US 8,037,158 B2

Page 6

- FedEx Kinko's Office & Print Services Inc., FedEx Corporate Services Inc.. Answering Brief/Response due date per Local Rules is Jan. 30, 2009. (Gaza, Anne) (Entered: Jan. 12, 2009).
- Order Granting 89 Unopposed Motion for Leave to Amend Answer. Signed by Judge Joseph J. Faman, Jr. on Jan. 13, 2009. (nms) (Entered: Jan. 14, 2009).
- First Amended Answer, Affirmative Defenses, and Counterclaims to Plaintiff re 1 Complaint, with Jury Demand by FedEx Corporation, FedEx Kinko's Office & Print Services Inc., FedEx Corporate Services Inc.. (nms) (Entered: Jan. 14, 2009).
- Redacted Version of 91 Opening Brief in Support, by FedEx Corporation, FedEx Kinko's Office & Print Services Inc., FedEx Corporate Services Inc.. (Attachments: # 1 Exhibit A-D)(Gaza, Anne) (Entered: Jan. 21, 2009).
- Amended Answer to 97 Answer to Complaint, Counterclaim by WebXchange Inc.. (Heaney, Julia) (Entered: Feb. 2, 2009).
- Motion to Bifurcate and for Early Trial on, the Issue of Inequitable Conduct—filed by FedEx Corporation, FedEx Kinko's Office & Print Services Inc., FedEx Corporate Services Inc.. (Gaza, Anne) Modified on Mar. 23, 2009 (nms). (Entered: Mar. 19, 2009).
- Notice of Motion re 108 Motion to Bifurcate and for Early Trial on, the Issue of Inequitable Conduct; Requesting the following Motion Day: Apr. 17, 2009 (Gaza, Anne) Modified on Mar. 23, 2009 (nms). (Entered: Mar. 19, 2009).
- Statement re 108 Motion to Bifurcate and for Early Trial on, the Issue of Inequitable Conduct by FedEx Corporation, FedEx Kinko's Office & Print Services Inc., FedEx Corporate Services Inc.. (Gaza, Anne) Modified on Mar. 23, 2009 (nms). (Entered: Mar. 19, 2009).
- Claim Construction Opening Brief Defendants' Opening Brief in Support of Their Proposed Claim Constructions filed by FedEx Corporation, FedEx Kinko's Office & Print Services Inc., FedEx Corporate Services Inc.. (McGeever, Elizabeth) (Entered: Mar. 23, 2009).
- Claim Construction Opening Brief filed by WebXchange Inc.. (Attachments: # 1 Exhibits A-B)(Heaney, Julia) (Additional attachment(s) added on Mar. 25, 2009: # 2 Main Document) (nms). (Entered: Mar. 23, 2009). (Two parts).
- Defendants' Motion for Leave to Amend Its Answer.
- Defendants' Brief in Support of Its Motion for Leave to Amend Answer // C.A No. 08-133 (JIF) // Dated: Jun. 12, 2009.
- UIUC , "The Common Gateway Interface", pp. 1-4, <http://hoohoo.ncsa.uiuc.edu/cgi/primer.html>, Retrieved on May 22, 2001.
- Arnold, K et al. , "Media-Independent Interfaces in a Media-Dependent World", Proceedings of the USENIX Conference on Object-Oriented Technologies, Monterey, CA, Jun. 1995 , WBX001.
- Arshad, K.M et al. , "A CORBA based framework for trusted E-Commerce Transactions", Enterprise Distributed Object Computing Conference, pp. 18-25, EDOC '99. Proceedings, 3rd International, Sep. 27, 1999 , WBX002.
- Atkinson, R. , RFC 1825: "Security Architecture for the Internet Protocol", Naval Research Laboratory, Category: Standards Track, Network Working Group, Aug. 1, 1995, WBX007.
- Banks, M. , "America Online: A Graphics-based Success", Link-Up, Jan./Feb. 1992 , WBX008.
- Banks, M. , "Compuserve for Windows", M.I.S Press, 1994, WBX009.
- Baquero, C. et al. , "Integration of Concurrency Control in a Language with Subtyping and Subclassing", Proceedings of the USENIX Conference on Object-Oriented Technologies, Monterey, CA, Jun. 1995 , WBX010.
- Barron, C. and Weil, B., "Dr. Dobbs Portal: Implementing a Web Shopping Cart", Online Transactions in PERL, Sep. 1, 1996 WBX011.
- Bharat, K. et al. , "Visual Obliq: A System for Building Distributed, Multi-User Applications by Direct Manipulation", SRC 130a, DEC, Oct. 31, 1995, WBX012.
- Bharat, K. et al. , "Distributed Applications in a Hypermedia Setting", Proc. of the International Workshop on Hypermedia Design, Montpellier, <http://www.cc.gatech.edu/gvupeople/PhdKrishna/WHID.html>, Jun. 1, 1995, WBX013.
- Birrell A. et al. , "Network Objects", SRC Research Report, Feb. 24, 1994, WBX014.
- Birrell A. et al. , "Implementing Remote Procedure Calls", Xerox Palo Alto Research Center, ACM Transactions, Feb. 1, 1994, WBX015.
- Bowen, C. et al. , "How to Get the Most out of CompuServe" 5th Ed. 1991, Random House, Inc. 1991, WBX016.
- Braden, R. et al. , RFC 1122: "Requirements for Internet Hosts—Communication Layers" Oct. 1, 1989, WBX017.
- Brando, T., "Comparing DCE and CORBA", Mitre Document MP 95B-93, Mar. 1, 1995, WBX018.
- Microsoft, 7,340,506—Appendix A to the Request for Inter Partes Re-examination of, Payne, Dec. 2008, WBX019.
- Broadvision, "Broadvision One-to-One: On-line Marketing and Selling Application System Developers' Guide", 1995, WBX020.
- Broadvision, "Broadvision One-to-One: On-Line Marketing and Selling Application System: Dynamic Command Center User's Guide", 1995, WBX021.
- Broadvision, "Broadvision One-to-One: On-Line Marketing and Selling Application System: Installation and System Administration Guide" 1995, WBX022.
- Broadvision, "Broadvision One-to-One: On-Line Marketing and Selling Application System: Technical Overview", 1995, WBX023.
- Microsoft, 7,340,506—Appendix B to the Request for Inter Partes Re-examination of, Ginter, Dec. 2008, WBX024.
- Business Wire , "Open Market releases first complete software solution" 1995, WBX025.
- Business Wire , "Sunsoft delivers early access release of Distributed Objects Environment", Jun. 14, 1995, WBX026.
- Case, J. et al. , "Network Management and the Design of SNMP", Connexions (ISSN 0894-5926), vol. 3, No. 3, Mar. 1989, WBX027.
- Microsoft, 7,340,506—Appendix C to the Request for Inter Partes Re-examination of, Popp, Dec. 2008, WBX028.
- Chung, S. et al. , "A Heterogeneous Distributed Information System", IEEE, pp. 443-447, 1993, WBX029.
- Courtney, A. , "Phantom: An Interpreted Language for Distributed Programming", Proceedings of the USENIX Conference on Object-Oriented Technologies, Monterey, CA, Jun. 1995, WBX030.
- Cybercash, "Affiliate Marketing Service", <http://www.cybercash.com/products/affiliatemarketing.html> [retrieved on May 23, 2001] 1996, WBX031.
- "CyberCash B2B Payment Services", <http://www.cybercash.com/b2b> pp. 1-2 [retrieved May 23, 2001] 1996, WBX032.
- "CyberCash B2B Services", 1996, WBX033.
- "CyberCash Cash Register Internet Payment Service". Web Page [online]. CyberCash Cash Register—Online Secure Payment Service. [retrieved on May 23, 2001] Retrieved from the Internet: <URL: <http://www.cybercash.com/cashregister> pp. 1-2. 1996, WBX034.
- "CyberCash—Cash Register—How it Works" [retrieved on May 23, 2001] Retrieved from the Internet: <URL: <http://www.cybercash.com/cashregister/howitworks.html> pp. 1-3. 1996, WBX035.
- "CyberCash—Industry Leading Features" Web Page [online]. [retrieved on May 23, 2001] Retrieved from the Internet: <URL: <http://www.cybercash.com/cashregister/features.html> pp. 1-4. 1996, WBX036.
- "CyberCash Cash Register—Online Secure Payment Service" CashRegister Demos. Web Page [online]. [retrieved on May 23, 2001] Retrieved from the Internet: <URL: <http://www.webdata.cybercash.com/demos/> pp. 1-2. 1996, WBX038.
- "CyberCash FraudPatrol.TM. Service" Web Page [online]. [retrieved on May 23, 2001] Retrieved from the Internet: <URL: <http://www.cybercash.com/fraudpatrol/> pp. 1-2. 1996, WBX039.
- "CyberCash FraudPatrol—How It Works" Web Page [online]. [retrieved on May 23, 2001] Retrieved from the Internet: <URL: <http://www.cybercash.com/fraudpatrol/howitworks.html> pp. 1-2 1996, WBX040.
- "CyberCash Home", <http://www.cybercash.com> [retrieved on May 23, 2001] 1996, WBX041.
- Microsoft, 7,340,506 Inter Partes Re-examination Exhibit 2, File History, Dec. 2008. (Two parts) WBX042.
- "CyberCash ICVerify for Windows" Version 2.5 Upgrade, <http://www.cybercash.com/icverify/upgrade.html> pp. 1-2 [retrieved on May 23, 2001] 1996 , WBX043.

US 8,037,158 B2

Page 7

- Cybercash, "ICVerify—Features" Web Page [online] [retrieved on May 23, 2001] Retrieved from the Internet: <URL:http://www.cybercash.com/icverify/features.html, 1996, pp. 1-3, WBX044.
- Cybercash, "Payment Software for Brick and Mortar Merchants" http://www.cybercash.com/pcauthorize 1996-2001, WBX046.
- Delaware WebXchange Claim Construction Introductory Brief, Mar. 26, 2009, WBX047.
- Cybercash, "Products" Web Page[online]. CyberCash, 1996. [retrieved on May 23, 2001]. Retrieved from the Internet:<URL:http://www.CyberCash.com/products/, 1996, pp. 1-2, WBX048.
- Microsoft, 7,340,506 Inter Partes Re-examination Request, Dec. 2008, WBX049.
- Cybercash, "WebAuthorize—Enterprise and Hosting Payment Processing". Web Page [online].[retrieved on May 23, 2001] Retrieved from the Internet:<URL:http://www.cybercash.com/webauthorize/, 1996, pp. 1-2, WBX050.
- Davis et al., "A Protocol and Server for a Distributed Digital Technical Report Library", Apr. 25, 1994, WBX051.
- Davison, A. , "Coding with HTML forms HTML goes interactive", (hypertext markup language)(Tutorial), Dr. Dobb's Journal, Jun. 6, 1995, vol. 20, No. 6, 19 pages, WBX052a.
- Davison, A. , "Coding with HTML forms: HTML goes interactive", Dr. Dobb's Journal, Jun. 6, 1995, vol. 20, No. 6, pp. 70-79, WBX052b.
- "Distributed Object Technology in the Financial Services Industry: Trading and Risk Management", A White Paper, Sun Microsystems, 1995, WBX053.
- Deng, R.H. et al. , "Integrating Security in CORBA-based Architectures", IEEE, Jun. 1995, pp. 50-61, WBX054.
- Detlefs, D. et al. , Debugging Storage Management Problems in Garbage Collected Environments, Proceedings of the USENIX Conference on Object-Oriented Technologies, Monterey, CA, Jun. 1995, WBX055.
- Dietinger, T. , Object-Oriented Implementation of a Multiprotocol Hyper-G client for MS-Windows, Diplomarbeit in Telematik, TU Graz, Jul. 1, 1995, WBX056.
- Dr. Gui on Components, COM and ATL, http://msdn.microsoft.com/library/welcome/dsmndn/msdn_druguion020298.htm, Feb. 2, 1998, pp. 1-61 [retrieved on May 22, 2001], WBX057.
- Edwards, N. , Object Wrapping (for WWW)—The Key to Integrated Services, ANSA Phase III, Apr. 25, 1995, WBX058.
- Ehikioya, S.A. , "An Agent-Based System for Distributed Transactions: a Model for Internet-Based transactions", Electrical and Computer Engineering, 1999 IEEE Canadian Conference on, vol. 1, May 9, 1999, pp. 289-294, WBX059.
- Microsoft DJ Order, C-08-05149 WHA "Order Granting Defendant's Motion to Dismiss", Federal Court of Northern California, Feb. 17, 2009, WBX060.
- "Portal Solutions, an Open Market eBusiness Solution Brief". White Paper. Open Market, Forrester Research TechRankings, Feb. 2001, WBX061.
- "Wireless Solutions, An Open Market eBusiness Solution Brief", WhitePaper. Open Market, Forrester Research TechRankings, Feb. 2001, WBX062.
- Fraga, J. et al. , "A Programming Model for Real-Time Applications in Open Distributed Systems", IEEE, 1995, pp. 104-111, WBX063.
- Dell, Fedex, Allstate, Delaware Claim Construction Introductory Brief_Defendants_Opening Brief in Support of Their Proposed Claim Constructions Mar. 23, 2009, Mar. 27, 2009, WBX064.
- Glossbrenner, A. , "MasterGuide to CompuServe", "Chapter 15: Travel Services: Join CompuServe and See the World", Prentice Hall, 1987, WBX065.
- Gross, C. , "Taking the Splash Diving into ISAPI Programming", ISAPI Programming, Microsoft Interactive Developer, <URL:http://www.Microsoft.com/mind/0197/ISAPI.htm, Jan. 1, 197, pp. 1-10 [retrieved on May 22, 2001], WBX066.
- "Open Market Inc. Managing in a Turbulent Environment", Harvard Business School, 9-196-097, Aug. 29, 1996, WBX067.
- Hickey, M., "Shopping at Home: One Modem Line, No Waiting", Home PC, Dec. 1, 1994, p. 307, Dialog, File 647, Acc# 01038162, WBX068A.
- Lang, "Cashing in: The Rush is on to Buy and Sell on the Internet But on Sidelines for Now", Advertising Age, Dec. 19, 1994, p. 11, Dialog, File 16, Acc# 05419137, WBX068B.
- Lichty, T. , "America Online Tour Guide", MacIntosh Edition, Version 2, Chapter 1, 3, 8,10, 1992, WBX068C.
- Tymnet, Wikipedia, the free encyclopedia, http://en.wikipedia.org/wiki/tymnet, Retrieved on May 1, 2007, WBX068D.
- Cox, B. et al. , "NetBill Security and Transaction Protocol", Carnegie Millon University, Pittsburgh, PA 15212-3890, undated, WBX068E.
- Lamond, K. et al. , "Credit Card Transactions Real World and OnLine", http://www.virtualschool.edu/mon/ElectronProperty/klamond/credit_card.htm, 1996, pp. 1-16, WBX068F.
- "Open Market Catalog Centre", Page [online. Open Market, Inc.—Enterprise Content Management & Delivery. Retrieved on the Internet:<URL:http://www.openmarket.com/cgi-bin/gx.cgi/AppLogic+FT+ContentServer?pagename=FutureTense/Apps/Xcelerate/Render&c=Arti_ZZZ, WBX069.
- Business Wire, High Beam Wire, "Open Market releases first complete software solution" Oct. 16, 1995, WBX070.
- McCloghrie, K. et al. , RFC 1156, "Management Information Base for Network Management of TCP/IP-based internets", May 1, 1990, WBX071.
- Case, J. et al. , RFC 1157 May 1, 1990, WBX072.
- Rose, M.. RFC 1283:"SNMP over OSI", Dec. 1, 1991, WBX073.
- Rose, M. et al. , RFC 1155: "Structure and Identification of Management Information for TCP/IP-based internets", May 1, 1990, WBX074.
- Case, J. et al. , RFC 1442: "Structure of Management Information for version 2 of the Simple Network Management Protocol (SNMPv2)", AllState 00011394 Apr. 1, 1993, WBX075.
- "ORBIX Programmer's Guide", IONA Technologies, Oct. 1, 1997, WBX076.
- "ORBIX Programmer's Guide", Release 1.3.1, IONA Technologies, Feb. 1, 1995, WBX077.
- Ito, J. et al. , "Using meta-objects to support optimization in the Apertos Operating System", Proceedings of the USENIX Conference on Object-Oriented Technologies, Monterey, CA, Jun. 1995, WBX078.
- Jordan, M. et al. , "Software Configuration Management in an Object-Oriented Database", Proceedings of the USENIX Conference on Object-Oriented Technologies, Monterey, CA, Jun. 1995, WBX079.
- Kane, P. , "Prodigy Made Easy", "Chapter 6, Shopping Made Easy", 2nd ed., 1993, WBX080.
- Lagoze, C. et al. , "Dienst: Implementation Reference Manual", May 5, 1995, WBX081.
- Open Market Commerce Products, Web Page[online]. Open Market Inc.—Enterprise Content Management Delivery. Retrieved on the Internet:<URL:http://www.openmarket.com/cgi-bin/gx.cgi/AppLogic+FTContentServer?pagename=FutureTense/Apps/Xcelerate/Render&c=A_ZZZ, WBX082.
- Lange, D.B. et al. , "Program Explorer: A Program Visualizer for C++", Proceedings of the USENIX Conference on Object-Oriented Technologies, Monterey, CA, Jun. 1995, WBX083.
- Laufer, K. , "A Framework for Higher Order Functions in C++", Proceedings of the USENIX Conference on Object-Oriented Technologies, Monterey, CA, Jun. 1995, WBX084.
- Li, G. and Bacon, J., "Supporting Distributed Real-Time Objects", IEEE Jul. 1994, pp. 138-143, WBX085.
- Limprecht, R. , "Microsoft Transaction Server", IEEE, Compcn '97 Proceedings, 1997, pp. 14-18, WBX086.
- Maffei, S. , "Adding Group Communication and Fault-Tolerance to CORBA", Proceedings of the USENIX Conference on Object-Oriented Technologies, Monterey,CA, Jun. 1995 , WBX087.
- Mahindra, A. et al. , "Dynamic Insertion of Object Services", Proceedings of the USENIX Conference on Object-Oriented Technologies, Monterey,CA, Jun. 1995, WBX088.
- McCloghrie, K. et al. , RFC 1213, "Management Information Base for Network Management of TCP/IP-based internets: MIB-II", SNMP Working Group, Mar. 1, 1991, WBX089.
- McCloghrie, K. et al., RFC 1447, "Party MIB for version 2 of the SIMPLE Network Management Protocol", SNMP Security Working Group, Apr. 1, 1993, WBX090.

US 8,037,158 B2

Page 8

- McKie, S., "ERP Meets Web E-Commerce", DBMS, Jul. 1, 1998, WBX091.
- McMaster D. et al., RFC 1516: "802.3 Repeater devices—Definition of Managed Objects", Feb. 9, 1992, WBX092.
- "Allstate Connects with Countrywide Producer Network in Seven Months Using Microsoft Visual Studio .NET and the NET Framework", Microsoft .NET Customer Solution, Jan. 2003, WBX093.
- O'Brien Jones, U.S. Appl. No. 90/010,346 Application which is the 5,778,178 Re-exam doc, Exhibits Part 1-WBX101, Exhibits Part 2-WBX102, Nov. 21, 2008 Third Party Requests, WBX094.
- "Microsoft Component Services, Server Operating System, A Technology Overview", <http://www.microsoft.com/com/wpaper/compsvcs.asp>, Aug. 15, 1998, [retrieved on May 22, 2001], WBX095.
- Microsoft vs WebXchange* Complaint CV 085149, Nov. 12, 2008, WBX096.
- Microsoft vs WebXchange* First Amended Complaint CV 085149, Mar. 3, 2009, WBX097.
- Allstate Uses Web Services to Quickly Create Insurance Policy Management Solution, Microsoft .NET Customer Solution Case Study, Jan. 2005, WBX098.
- Mitchell et al., "An Overview of the Spring System", Sun Microsystems, WBX099.
- Muckelbauer, P. and Russo, V., "Lingua Franca: An IDL for Structured Subtyping Distributed Object Systems" Proceedings of the USENIX Conference on Object-Oriented Technologies, Monterey, CA., WBX100.
- O'Brien Jones, 5,778,178 Request for Ex Parte Re-Exam with Exhibits Part 1, Nov. 21, 2008, WBX101.
- Reynolds, J. Posting to comp doc USENET group, <http://nyurl.com/53a95p>, RFC 1212, 1213- Google groups on concise definitions MIB and MIBII, Exhibit G, Mar. 27, 1991, WBX045.
- Relihan, L. et al., "Untangling the World-Wide Web." Proceedings of the 12th Annual International Conference on Systems Documentation, Oct. 1, 1994, pp. 17-24, published by the Association of Computing Machinery, WBX102A.
- O'Brien Jones, 5,778,178 Request for Ex Parte Re-Exam with Exhibits Part 2, Nov. 21, 2008, WBX102B.
- Rose, M. T., "The Simple Book: An Introduction to Internet Management", 1994, pp. 14-15, 379-387 (2nd ed.) Exhibit F, WBX102C.
- "Open Market Enterprise Content Management and Delivery: Content Server", <URL:<http://www.openmarket.com/cgi-bin/gx.cgi/AppLogic+FTContentServer?pagename=FutureTense/Apps/Xcelerate/Render&c=Artic...>, retrieved on May 15, 2001, pp. 1-4, WBX103.
- "Open Market Enterprise Content Management and Delivery: Content Center", <URL:<http://www.openmarket.com/cgi-bin/gx.cgi/AppLogic+FTContentServer?pagename=FutureTense/Apps/Xcelerate/Render&c=Artic...>, retrieved on May 15, 2001, WBX104.
- "Open Market Enterprise Content Management and Delivery: Content-Driven eBusiness Solutions", Web site [retrieved on May 15, 2001] <URL:<http://www.openmarket.com/cgi-bin/gx.cgi/AppLogic+FTContentServer?pagename=FutureTense/Apps/Xcelerate/Render&c=Artic...>, retrieved on May 15, 2001, WBX105.
- "Open Market ShopSite 5.0", Web Page[online]. [retrieved on May 15, 2001]. Retrieved on the Internet:<URL:<http://www.openmarket.com/cgi-bin/gx.cgi/AppLogic+FTContentServer?pagename=FutureTense/Apps/>, retrieved on May 15, 2001, WBX112.
- Orfali, R. et al., "Essential Client/Server Survival Guide"-John Wiley and Sons—Set 1, 1994, WBX114.
- Orfali, R. et al., "Essential Client/Server Survival Guide"-John Wiley and Sons—Set 2, 1994, WBX115.
- WBX116 Orfali, R.; Harkey, D.; Edwards, J., "Essential Client/Server Survival Guide" John Wiley and Sons, Sets 1-4, Jun. 16, 2005, WBX116.
- Orfali, R. et al., "Essential Client/Server Survival Guide"-John Wiley and Sons—Set 4, 1994, WBX117.
- Pavlou, G. et al., "A Generic Management Information Base Browser", WBX119.
- Peterson, L. et al., "Computer Networks, A Systems Approach", Morgan Kaufmann Publishers, Inc., 1996, pp. 472-507, WBX120.
- Pitkow, J. et al., "Using the Web as a Survey Tool: Results from the Second WWW User Survey", conducted on Oct. 15 and Nov. 1994, presented at the Third International World-Wide-Web Conference in Darmstadt, Germany, Apr. 10-14, 1995, WBX121.
- Netscape Unveils New Versions of Commercial Applications for Enhanced Integration with Corporate Databases, NetScape Press Release, May 13, 1996, WBX122.
- Raatikainen, K., "Database Access in Intelligent Networks", Proceedings of IFIP TC6 Workshop on Intelligent Networks, pp. 163-183, WBX123.
- Radia, S. R. et al., "The Spring Object Model", Proceedings of the USENIX Conference on Object-Oriented Technologies, Monterey, CA, Jun. 1995, WBX124.
- Rosenberry, et al., "OSF Distributed Computing Environment—Understanding DCE"—O'Reilly & Associates, Jun. 1993, WBX126.
- Rubin, C. "Wired: In the Bag", Jun. 1997, WBX127.
- Schepp et al., "The Complete Guide to CompuServe: Chapter 12: Travel Services: See the World Today the CompuServe Way", 1990, pp. 409-437, McGraw Hill, WBX128.
- Schmidt, D. et al., "Object-Oriented Components for High-Speed Network Programming", Proceedings of the USENIX Conference on Object-Oriented Technologies, Monterey, CA, Jun. 1995, WBX129.
- Siegel, J., "Common Object Services Specification vol. 1, Rev 1, First Edition", OMG Doc 94-1-1, Mar. 1, 1994, WBX130.
- "Common Desktop Environment: Product Glossary", SunSoft, 1994-1995, WBX131.
- "Common Desktop Environment: Applications Builder User's Guide", SunSoft, 1994-1995, WBX132.
- "OpenStep Development Tools", SunSoft, 1996, WBX133.
- Porting NextStep 3.2/3.3 Applications to OpenStep on Solaris, Sunsoft, 1996, WBX134.
- "Solstice X.500 Programming Reference", SunSoft, 1996, WBX135.
- Tatters, W., "Navigating the Internet with Compuserve: Chapter 17: Business on the Net", 1995, pp. 352-374, Sams Publishing, WBX136.
- Technical Staff, "The Conductor Financial Services Framework": Distributed Objects on the Internet, A Block Financial Corporation White Paper, BFC Technology Center, Oct. 17, 1995, WBX137.
- US Patent 5,778,178, Re-exam Order Granted, Jan. 23, 2009, WBX142.
- US Patent 7,340,506, Re-exam Order Mar. 6, 2009, WBX143.
- Vogler, H. et al., "The Transaction Internet Protocol in Practice: Reliability for WWW Applications", IEEE 1999 Internet Workshop IWS99, (ISSN-0-7803-5925-9), Feb. 18, 1999, WBX146.
- 7,340,506 Inter Partes Re-examination Exhibit 3-WebXchange Claim Construction Introductory Brief, In the US District Court for the District of Delaware, C.A. No. 08-131 (JJF), C.A. 08-132 (JJF), No. 08-133 (JJF), Microsoft, Oct. 29, 2008, WBX148.
- Microsoft, 7,340,506 Inter Partes Re-examination Exhibit 5-08-168,519 FH—'519 Application Final, WBX149.
- Weich, C., "Generic Containers for a Distributed Object Store", Proceedings of the USENIX Conference (Jun. 1995) on Object-Oriented Technologies, Monterey, CA, May 18, 1995, WBX150.
- WBX151, "SmallTalk" Wikipedia SmallTalk <http://www.objs.com/x3h7/smalltalk.htm> and <http://en.wikipedia.org/wiki/Smalltalk> WBX151.
- Wollrath, A. et al., "Simple Activation for Distributed Objects", Proceedings of the USENIX Conference on Object-Oriented Technologies, Monterey, CA, Jun. 1995, WBX152.
- USENIX, "Agenda of Proceedings of the USENIX Conference on Object-Oriented Technologies", Monterey, CA, Jun. 1995, WBX153.
- "Common Desktop Environment: Desktop Kornshell User's Guide", Sun Microsystems, 1994-1995, WBX154.
- "Common Desktop Environment: Help System Author's and Programmer's Guide", Sun Microsystems, 1994-1995, (Three parts) WBX155.
- "Common Desktop Environment: Internationalization Programmer's Guide", Sun Microsystems, 1994-1995, WBX156.
- "Common Desktop Environment: Tooltalk Messaging Overview", Sun Microsystems, 1994-1995, WBX157.

US 8,037,158 B2

Page 9

- “Common Desktop Environment: Common StyleGuide and Certification Checklist”, SunSoft, 1994-1995 , WBX158.
- “Common Desktop Environment: Programmer’s Overview”, SunSoft, 1994-1995 , WBX159.
- Developer’s Guide to Internationalization, Sun Microsystems, 1994, WBX160.
- “Dr. Gui’s Gentle Guide to COM”, <http://www.microsoft.com/Com/news/drgui.asp> [retrieved on May 22, 2001], Nov. 1, 1999, WBX161.
- “iPIN Company Info”, <http://www.ipin.com/01comp.html> [retrieved on May 23, 2001], iPIN Interactive Transaction Services, Inc., 2000, WBX162.
- “iPIN Home”, <http://www.ipin.com> [retrieved on May 23, 2001], iPIN Interactive Transaction Services, Inc., 2000, WBX163.
- “iPIN Service Options”, http://www.ipin.com/02prod_service.html [retrieved on May 23, 2001], iPIN Interactive Transaction Services, Inc., 2000, WBX164.
- “iPIN Solutions”, http://www.ipin.com/02prod_solution.html [retrieved on May 23, 2001], iPIN Interactive Transaction Services, Inc., 2000, WBX165.
- “iPIN Partners”, <http://www.ipin.com/03part.html> [retrieved on May 23, 2001], iPIN Interactive Transaction Services, Inc., 2000, WBX166.
- “iPIN Technology”, http://www.ipin.com/02prod_tech.html [retrieved on May 23, 2001], iPIN Interactive Transaction Services, Inc., 2000, WBX167.
- NetScape Products: Open and Secure Internet Software, 1995, WBX168A.
- NetScape Merchant System, Data Sheet 1995, WBX168B.
- NetScape Internet Applications, Customer Showcase 1995, WBX168C.
- NetScape Server API, 1995, WBX 168D.
- NetScape Object-Oriented Paradigm of Server Configuration, 1995, WBX168E.
- RSA: Verisign Redirection Information, Important Announcement 1995, WBX168F.
- RSA: Verisign to Provide Digital IDs for Open Market’s Secure WebServer, 1995, WBX168G.
- Verisign Adds the Missing Component to Online Security Solutions 1995, WBX168H.
- Hickman, K.E.B.; Netscape, “The SSL Protocol”, 1995, WBX168I.
- NetScape iStore DataSheet, 1995, WBX168J.
- Choudhury, A.K. et al. , “Copyright Protection for Electronic Publishing over Computer Networks”, 1995 IEEE Network, 9, May/June, vol. 3 pp. 12-20 (1995) WBX168L.
- NSAPI Basics, (Chapter 1) <http://developer.netscape.com/docs/manuals/enterprise/nsapi/svrop.htm> [retrieved on May 22, 2001], 1997, WBX174.
- “OpenStep User Interface Guidelines”, SunSoft, 1996, WBX175.
- “OpenStep Programming Reference”, SunSoft, 1996 , (12 parts) WBX176.
- “QuickStart to Using the Open Step Desktop”, SunSoft, 1996, WBX177.
- Rose, M. et al. , “RFC 1065:Structure and Identification of Management Informationfor TCP/IP-based internets”,Aug. 1, 1988, WBX178.
- Stewart, B. , RFC 1318: “Definition of Managed Objects for Parallel-printer-like Hardware Devices”, Apr. 1, 1992 , WBX179.
- Kane, P. , “Prodigy Made Easy”, “Chapter 6, Shopping Made Easy”, 2nd ed., 1993, WBX080.
- Lagoze, C. et al. , “Dienst: Implementation Reference Manual”, May 5, 1995, WBX081.
- Rivest, R., “RFC 1321: The MD5 Message-Digest Algorithm”, 1997, WBX180.
- Solaris Common Desktop Environment: MOTIF Transition Guide, Sun Microsystems, 1997, WBX181.
- “Solaris Common Desktop Environment: Programmer’s Guide”, Sun Microsystems, 1994-1995, WBX182.
- “The iPin Approach”, <http://www.ipin.com/02prod.html>, 2000, [retrieved on May 23, 2001], Interactive Transaction Services, Inc., WBX183.
- USPTO , 7,340,506—Notice of assignment of inter partes reexamination request, Jan. 1, 2009, WBX200.
- Orfali, R. et al. , “The Essential Distributed Objects Survival Guide”—Part-1, John Wiley and Sons, 1996, WBX201.
- Orfali, R. et al. , “The Essential Distributed Objects Survival Guide”—Part-2, John Wiley and Sons, 1996 , WBX202.
- Orfali, R. et al. , “The Essential Distributed Objects Survival Guide”—Part-3, John Wiley and Sons, 1996, WBX203.
- Orfali, R. et al. , “The Essential Distributed Objects Survival Guide”—Part-2-1, John Wiley and Sons, 1996, WBX204.
- Orfali, R. et al. , “The Essential Distributed Objects Survival Guide”—Part-2-2, John Wiley and Sons, 1996 , WBX205.
- Orfali, R. et al. , “The Essential Distributed Objects Survival Guide”—Part-2-3, John Wiley and Sons, 1996, WBX206.
- Orfali, R. et al. , “The Essential Distributed Objects Survival Guide”—Part-3-1, John Wiley and Sons, 1996 , WBX207.
- Orfali, R. et al. , “The Essential Distributed Objects Survival Guide”—Part-3-2, John Wiley and Sons, 1996 , WBX208.
- Orfali, R. et al. , “The Essential Distributed Objects Survival Guide”—Part-3-3, John Wiley and Sons, 1996, WBX209.
- Orfali, R. et al. , “The Essential Distributed Objects Survival Guide”—Part-4-1, John Wiley and Sons, 1996, WBX210.
- Orfali, R. et al. , “The Essential Distributed Objects Survival Guide”—Part-4-2, John Wiley and Sons, 1996, WBX211.
- Orfali, R. et al. , “The Essential Distributed Objects Survival Guide”—Part-4-3, John Wiley and Sons, 1996, WBX212.
- Orfali, R. et al. , “The Essential Distributed Objects Survival Guide”—Part-4-4, John Wiley and Sons, 1996 , WBX213.
- Broadvision , “Broadvision One-to-One: Programmer’s Reference, Part 1” 1995 , WBX214.
- Broadvision , “Broadvision One-to-One: Programmer’s Reference, Part 2” 1995 , WBX215.
- OMG , “The Common Object Request Broker: Architecture and Specification”, CORBA v2.0_(NYC-#1655390-v1), Jul. 1995-1996, WBX216.
- NYC-#1579692-v1-WebXchange —_March_3_DELL_Complaint.Doc, Mar. 3, 2008, WBX217.
- NYC-#1579751-v1-WebXchange —_March_3_Allstate_Complaint.Doc, Mar. 3, 2008, WBX218.
- NYC-#1579947-v1-WebXchange —_March_3_FedEx_Complaint.Doc, Mar. 3, 2008, WBX219.
- The Open Group , “Inter-domain Management: Specification Translation”, 1997, WBX222.
- The Open Group , “Inter-domain Management_Summary of Similarities and Differences”, 1997, WBX223.
- The Open Group , “Inter-domain Management_object models comparison”, 1997, WBX224.
- Miller, M. , “Managing Internetworks with SNMP”, 1993, pp. 138-139, M&T Books., ’506 Inter Partes Re-examination Exhibit 12, Dec. 2008, WBX225.
- Umar, A. , “Distributed Computing: A Practical Synthesis”, “Appendix B: Tutorial on TCP/IP Protocol Suite”, (BellCore), 1993, WBX226.
- Umar, A. , “Distributed Computing: A Practical Synthesis”, “Chapter 5: Client-Server Systems and Application—Interconnectivity”, (BellCore), 1993, WBX227.
- Spero , “Binary Gateway Interface—An API for Dynamically Extensible http Servers”, Jul. 1, 1994, Retrieved on Apr. 5, 2009 from <http://www.ibiblio.org/mdma-release/BGI-spec.txt> , WBX228.
- “Point, Click and Shop’ Never So Easy;The CheckFree Wallet(TM) Allows Consumers and Merchants to Conduct Simple, Safe Internet Transactions” NewsHound, San Jose Mercury News, PRNewswire, Apr. 10, 1995, Retrieved on Apr. 5, 2009 from http://besser.tsoa.nyu.edu_ZZZ, WBX229.
- “DEC ObjectBroker Service”, Comp.Object FAQ Version 1.0.9 (Apr. 2002) Part 3/13, Apr. 3, 1996, Retrieved on Apr. 5, 2009 from http://209.85.173.132/search?q=cache:c3iJxZca3aUJ:www.faqs.org/faqs/object-faq/part3/+DEC%27s+ObjectBroker+Service&cd=9&hl=en&ct=clnk&g_ZZZ, WBX230.
- “Easel Corporation Introduces Comprehensive Program for Expanding Object Technology Expertise”, Mar. 13, 1995, Business Wire, Retrieved on Apr. 5, 2009 from http://209.85.173.132/search?q=cache:MscjZC2srEJ:findarticles.com/p/articles/mi_m0EIN/is_1995_Marc_ZZZ, WBX231.

US 8,037,158 B2

Page 10

- "Internet Information Commerce: The First Virtual (TM) Approach", Jul. 1995, Proceedings of the First USENIX Workshop on Electronic Commerce, New York, New York, Retrieved on Apr. 5, 2009 from http://www.usenix.org/publications/library/proceedings/ec95/f_ZZZ, WBX232.
- "O'Reilly Releases Website (TM) Web Server for Windows NT", WebView, EIT (Enterprise Integration Technologies), May 12, 1995, vol. 7 : Issue 41, ISSN 1004-042X, Computer underground Digest, Retrieved on Apr. 5, 2009 from http://cu-digest.org/CUDS7/cud74_ZZZ, WBX233.
- "RSA and EIT Joint Venture Will Make Internet Transactions Secure", Terisa Systems, EIT and RSA: Secure HTTP, Jun. 13, 1994, Retrieved on Apr. 5, 2009 from <http://1997.webhistory.org/www.lists/www-talk.1994q2/0980.html>, WBX234.
- "CommerceNet The First Large-Scale Market Trial of Electronic Commerce on the Internet" EIT: CommerceNet, Aug. 3, 1994, Proceedings of the May 1994, Ties That Bind: Building Community Networks conference, Retrieved on Apr. 5, 2009 from http://internet.eser_ZZZ, WBX235.
- Rubin, A., "IETF—Stockholm meeting" NetCheck: E-signatures, Aug. 5, 1995, pp. 1-2, CIPHER, Newsletter of the IEEE Computer Society's TC on Security and PrivacyElectronic, Issue 8, Retrieved on Apr. 5, 2009 from http://www.ieee-security.org/Cipher/PastIssu_ZZZ, WBX236.
- Open Market, "FastCGI: A High-Performance Web Server Interface", Apr. 1996, Retrieved on Apr. 5, 2009 from <http://www.fastcgi.com/devkit/doc/fastcgi-whitepaper/fastcgi.htm>, WBX237.
- Sun Microsystems, "HotJava", Wikipedia, the free encyclopedia, Jun. 1995, Retrieved on Apr. 5, 2009 from <http://en.wikipedia.org/wiki/HotJava>, WBX238.
- W3C Status Codes, HTRESP_html_w3_org, 1992 WBX239.
- Hewlett Packard, "HP Odapter/OpenODB", Jul. 1994, Retrieved on Apr. 5, 2009 from <http://web.billkent.edu.tr/Online/oofaq/oo-faq-S-8.13.0.5.html>, WBX240.
- Internet Shopping Network_ISN Business Newswire (1995) WBX241.
- NCR Co-operative Frameworks 3, (1993) WBX242.
- Distributed Objects Everywhere, NEO, Wikipedia (1996) WBX243.
- NetMarket (1996) WBX244.
- Enterprise Object Netorks, Wikipedia (1996) WBX245.
- OMG Document No. 91_12_1 Revision 1_1 (1997) WBX246.
- DigiCash Smartcards (1997) WBX247.
- IBM System Object Model_SOM (1998) WBX248.
- IBM System Object Model_SOM_DSOM (1998) WBX249.
- Open Market StoreBuilder (1995) WBX250.
- WebXpress Web StoreFront (1996) WBX251.
- PNC, Industry.Net do eCommerce (1996) WBX252.
- 10KPowerShip,PowerPartner (1996) WBX253.
- T. Berners Lee Hypertext Mark up Language RFC1866(1995) WBX 254.
- E. Nebel RFC1867 (1995) WBX255.
- RFC1942 (1996) WBX256.
- J. Seidman RFC1980 (1996) WBX257.
- HTML—Wikipedia, the free encyclopedia—Notepad (1998) WBX258.
- Berners-Lee, T., RFC 1630, "Universal Resource Identifiers in WWW", Network Working Group, CERN, Jun. 1994 WBX259.
- Object Broker Service Middleware Sourcebook (1995) WBX260.
- Inter Parte Re-Examination U.S. Appl. No. 95/001,129 (2008) WBX261.
- 6,212,556 Re-exam file history U.S. Appl. No. 90/010,417 filed (2009) WBX262.
- U.S. Appl. No. 11/980,185 prosecution history filed 2008, prosecution history as of Mar. 12, 2009 WBX263.
- WebX Opening Brief District of Delaware Mar. 23, 2009 WBX264.
- U.S. Patent 5,778,178 Re_Examination of 90010346_178 prosecution history through Aug. 20, 2009 WBX267.
- WBXexecsummary4809new2bizplan[1] (2009) WBX268.
- Kramer, Douglas Java Whitepaper May 1996, WBX500.
- 09863704 Response to Non-Final Office Action Jun. 6, 2006, WBX501.
- 09863704 Response to Non-Final Office Action Jul. 23, 2008 and Examiner Interview Summaries dated Jul. 2, 2008 and Jul. 16, 2008, WBX502.
- 09863704 Response to Non-Final Office Action Aug. 21, 2007, WBX503.
- 09863704 Response to Non-Final Office Action Nov. 28, 2008, WBX504.
- 09863704 Final Office Action Apr. 20, 2005, WBX505.
- 09863704 Final Office Action Sep. 8, 2006, WBX506.
- 09863704 Final Office Action Oct. 31, 2007, WBX507.
- 09863704 Non-Final Office Action Feb. 14, 2004, WBX508.
- 09863704 Non-Final Office Action Feb. 23, 2007, WBX509.
- 09863704 Non-Final Office Action Apr. 14, 2008, WBX510.
- 09863704 Non-Final Office Action Sep. 18, 2009, WBX511.
- 09863704 Non-Final Office Action Dec. 6, 2005, WBX512.
- 09863704 RCE Feb. 1, 2008, WBX513.
- 09863704 RCE Jun. 30, 2009, WBX514.
- 09863704 RCE Sep. 22, 2005, WBX515.
- 09863704 RCE Dec. 8, 2006, WBX516.
- 11980185 Restriction Requirement Oct. 19, 2009, WBX517.
- 90010417 Determination Re-exam Ordered May 20, 2009, WBX518.
- File History of U.S. Patent 5,778,178, WBX519.
- File History of U.S. Patent 5,987,500, WBX520.
- File History of U.S. Patent 6,212,556, WBX521.
- File History of U.S. Patent 7,340,506, WBX522.
- Settlement with Allstateby WebXchange (2009), WBX523.
- Arunachalam, U.S. Appl. No. 09/863,704_2nd_rule56_disclosure.pdf, Mar. 4, 2009, WBX006.
- Arunachalam, U.S. Appl. No. 11/980,185_Duty of Candor Rule 56 Disclosure, Feb. 11, 2009, WBX220.
- Arunachalam, U.S. Appl. No. 11/980,185_Duty of Candor Rule 56 Disclosure, Mar. 4, 2009, WBX221.
- U.S. Appl. No. 12/628,060, filed Nov. 30, 2009, Arunachalam.
- U.S. Appl. No. 12/628,066, filed Nov. 30, 2009, Arunachalam.
- U.S. Appl. No. 12/628,068, filed Nov. 30, 2009, Arunachalam.
- U.S. Appl. No. 12/628,069, filed Nov. 30, 2009, Arunachalam.
- Order, Motion to Bifurcate and for early trial on the Issue of Inequitable Conduct, on Mar. 19, 2009, Dismissal with Prejudice, order dated Dec. 30, 2009, Denied as Moot, Order Granted, signed by JJJ, C.A. No. 08-131 (JJF).
- Order, Motion to Bifurcate and for early trial on the Issue of Inequitable Conduct, on Mar. 19, 2009, Dismissal with Prejudice, order dated Dec. 30, 2009, Denied as Moot, C.A. No. 08-132 (JJF) and C.A. No. 08-133 (JJF), signed by JJJ, Order, Motion to Bifurcate and for early trial on the Issue of Inequitable Conduct, on Mar. 19, 2009, Dismissal with Prejudice, order dated Dec. 30, 2009, Denied as Moot, C.A. No. 08-132 (JJF) and C.A. No. 08-133 (JJF).
- Plaintiff WebXchange Inc.'s Surreply in Opposition to Defendants' Motion to Bifurcate, and for Early Trial on, the Issue of Inequitable Conduct (C.A. No. 08-132 (JJF) and C.A. No. 08-133 (JJF), is Granted Plaintiff's Surreply in Opposition to Defendant's Motion to Bifurcate and for Early Trial on, The Issue on Inequitable Conduct is deemed filed (Entered Dec. 30, 2009).
- Dell Inc.'s Second Amended Answer and Counterclaims to WebXchange Inc.'s Original Complaint for Patent Infringement (Entered: Jan. 20, 2010).
- Plaintiff WebXchange Inc.'s Surreply in Opposition to Defendants' Motion to Bifurcate, and for Early Trial on, The Issue of Inequitable Conduct (Entered Dec. 30, 2009).
- Memorandum Opinion C.A. 08-133-JJF, and C.A. 08-132-JJF (Entered Dec. 30, 2009).
- Defendant's Fedex Corporation, Fedex Kinko's Office & Print Services, Inc., and Fedex Corporate Services, Inc.'s Second Amended Answer, Affirmative Defenses, and Counterclaims to Plaintiff WebXchange, Inc.'s Complaint (Entered Jan. 20, 2010).
- International Search Report, PCT/US9618165, Feb. 14, 1997.
- Ramanathan, S. et al., 'Architectures for Personalized Multi-Media', 1994 IEEE MultiMedia, Spring #1, Los Alamitos, CA, 1994, pp. 37-46, ReedFax Selected Papers, WBX168.
- 'Solaris Common Desktop Environment: Programmer's Guide', Sun Microsystems, 1994-1995, WBX182.

US 8,037,158 B2

Page 11

- Business Wire 'Internet Shopping Network (ISN)', Apr. 11, 1995, NewsHound, San Jose Mercury News, Retrieved on Apr. 5, 2009 from <http://bessertsoa.nyu.edu/impact/w95/RN/apr14news/Merc-news-isn.html>, WBX241.
- NEO, Sun Microsystems, 1995, VVikipedia, Retrieved on Apr. 5, 2009 from http://en.wikipedia.org/wiki/Distributed_Objects_Everywhere WBX243.
- Belisle, D., IBM System Object Model, SOM technologies developed by IBM, 1992, National Committee for Information Technology Standards, Technical Committee H7 Object Model Features Matrix Doc. No. X3H7-93-007v12b, [Retrieved on Apr. 5, 2009 from <http://www.omg.org/docs/1991/91-12-01.pdf>]WBX248.
- CNET Staff Writer, "PNC, Industry.Net do e-commerce", Sep. 25, 1996, CNET News Retrieved on Apr. 5, 2009.
- 1996 Fedex 10K Report, PowerShip, PowerPartner, FedEx, Aug. 9, 1996, BuckMaster, Retrieved on Apr. 5, 2009 from <http://buck.com/10k?tenkyear=968jcbc=F&co=FDX&nam=DEMO&pw=DEMOWBX253>.
- Digital Press, 'The Middleware Souce Book', Colonna, Romano and Sprite, Boston 1995 pp. 454-537. WBX254.
- Request for Ex Parte Re-examination of U.S. Patent No. 7,340,506 filed Dec. 19, 2008. Now control U.S. Appl. No. 95/001,129.
- Request for Ex Parte Re-examination of U.S. Patent No. 6,212,556 filed Feb. 23, Now control U.S. Appl. No. 90/010,417.
- Digital E-Meter Project—Sources #1 DE-1.
- WWWX03 Network Working Group RFC 1122, R. Brandon, "Requirements for Internet Hosts—Communications Layers", 1989.
- WWWX06 DEC Systems Research Center Report #115, Andrew Birrell et al., "Network Objects".
- WWWX07 PCT Application, Lakshmi Arunachalam, PCT/US96/18165.
- Arunachalam, 60-006634 60-006634 Provisional Patent_506 Inter Panes Re-examination Exhibit 13, Nov. 13, 1995, WBX005.
- 'CyberCash-Why Choose CashRegister?' Web Page[online]. [retrieved on May 23, 2001] Retrieved from the Internet: <URL:<http://www.cybercash.com/cashregister/why.html> 1996, WBX037.
- 'Open Market Commerce Products', Web Page[online]. Open Market Inc. Enterprise Content Management Delivery. Retrieved on the Internet <URL:<http://www.openmarket.com/cgi-bin/gx.cgi/AppLogic+FTContentServer?pagename=FutureTense/Apps/Xcelerate/Render&c=Artic> ...retrieved on May 15, 2001, pp. 1-2, WBX082.
- 'Open Market Enterprise Content Management and Delivery: Personalization Center', <URL:<http://www.openmarket.com/cgi-bin/gx.cgi/AppLogic+FTContentServer?pagename=FutureTense/Apps/Xcelerate/Render&c=Artic>., retrieved on May 15, 2001, WBX108.
- "Open Market Enterprise Content Management and Delivery: Satellite Server", <URL:<http://www.openmarket.com/cgi-bin/gx.cgi/AppLogic+FTContentServer?pagename=FutureTense/Apps/Xcelerate/Render&c=Artic>., retrieved on May 15, 2001, pp. 1-4, WBX109.
- Reynolds, J. Posting to comp doc USENET group, <http://nyurl.conV53a95p>, RFC 1212, 1213- Google groups on concise definitions MIB and MIBII, Exhibit G, Mar. 27, 1991 WBX102.
- K. McCoughrie and J. Galvin. Request. For Comments 1447, Party MIB. for version 2 of the Simple Network Management Protocol, published by the SNMP Security Working Group (Apr. 1993).
- Computer Dictionary "The Comprehensive Standard for Business, School, Library, and Home" 1993, Microsoft Press, Second Edition, p. 344.
- iPIN Partners Web Page[online]. iPIN Interactive Transaction Services, Inc. 2000. [retrieved on May 23, 2001] Retrieved from the Internet <URL:<http://www.ipin.com/03part.html> pp.
- Server Operating System a Technology Overview, Microsoft Component Services. White Paper [online] MicrosoftCOM. [retrieved on May 22, 2001]. Retrieved from the Internet <URL:<http://www.microsoft.com/com/wpaper/compsyscs.asp> pp. 1-8.
- Christian Gross. Taking the Splash Diving into ISAPI Programming. White Paper [online]. ISAPI Programming, Microsoft Interactive Developer, Jan. 1997. [retrieved on May 22, 2001]. Retrieved from the Internet <URL:<http://www.Microsoft.com/mind/0197/isapi.htm> pp. 1-10.
- The Common Gateway Interface. Web Page [online]. [retrieved on May 22, 2001]. Retrieved from the Internet: <URL:<http://hoo.hoo.ncsa.uiuc.edu/cgi/primer.html> pp. 1-4.
- Open Market Content-Driven eBusiness Solutions. Web Page[online]. Open Market [retrieved on May 15, 2001] Retrieved on the Internet <URL:<http://www.openmarket.com/cgi-bin/gx.cgi/AppLogic+FTContentServer?pagename=FutureTense/Apps/Xcelerate/Render&c=Articpp.1-3>.
- Open Market Content Server. Web Page[online]. Open Market. [retrieved on May 15, 2001] Retrieved on the Internet: <URL:<http://www.openmarket.com/cgi-bin/gx.cgi/AppLogic+FTContentServer?pagename=FutureTense/Apps/Xcelerate/Render&c=Artic>., pp. 1-4.
- Open Market Integration Centre. Web Page[online]. Open Market, Inc.—Enterprise Content Management & Delivery. [retrieved on May 15, 2001]. Retrieved on the Internet <URL:<http://www.openmarket.com/cgi-bin/gx.cgi/AppLogic+FTContentServer?pagename=FutureTense/Apps/Xcelerate/Render&c=Artic>.
- Open Market Marketing Studio. Web Page [online]. Open Market Inc.—Enterprise Content Management Delivery. [retrieved on May 15, 2001]. Retrieved on the Internet <URL:<http://www.openmarket.com/cgi-bin/gx.cgi/AppLogic+FTContentServer?pagename=FutureTense/Apps/Xcelerate/Render&c=Articpp.1-4>.
- Open Market ShopSite 5.0. Web Page [online]. [retrieved on May 15, 2001]. Retrieved on the Internet: <URL:<http://www.openmarket.com/cgi-bin/gx.cgi/AppLogic+FTContentServer?pagename=FutureTense/Apps/B2BPaymentServices>. Web Page[online]. CyberCash, 1996. [retrieved on May 23, 2001]. Retrieved from the Internet: <URL:<http://www.cybercash.com> pp. 1-2.
- CVERIFY for Windows.2.5 Upgrade. Web Page[online]. CyberCash ICVERIFY 2.5 Upgrade, 1996. [retrieved on May 23, 2001] Retrieved from the Internet <URL:<http://www.Cybercash.com/icverify/upgrade.html> pp. 1-2.
- CyberCash Corporate Information, CyberCash B2B Payment Services. Web Page [online]. [retrieved on May 23, 2001] Retrieved from the Internet <URL:<http://www.cybercash.com/b2b/> pp. 1-2.
- RFC1630.
- Orfali, R.; Harkey, D.; Edwards, J., 'Essencial Client/Server Survival Guide' John Wiley and Sons, Sets 1-4, Jun. 16, 2005 WBX114, WBX115, WBX116, WBX117.
- Orfali, R.; Harkey, D.; Edwards, J., 'The Essential Distributed Objects', Parts 1-1, 1-2, 1-3, 2-1, 2-2, 2-3, 3-1, 3-2, 3-3, 4-1, 4-2, 4-3 & 4-4 WBX201, WBX202, WBX203, WBX204, WBX205, WBX206, WBX207, WBX208, WBX209, WBX210, WBX211, WBX212, WBX213.
- Rosenberry, W. et al., "OSF Distributed Computing Environment—Understanding DCE", O'Reilly and Associates, Jun. 1993 WBX238.
- Common Desktop Environment: Help System Authors and Programmers Guide, Sun Microsystems WBX155.
- Raggett, D., RFC 1942, "HTML Tables", May 1996, WBX 256.
- CyberCash Payment Software for Brick and Mortal merchants, <http://www.cybercash.com/pauthorize>, CyberCash, 1996-2001 WBX046.
- The E-Commerce Leader in Payment Processing PC Authorize, <http://www.cybercash.com/pauthorize>, CyberCash, 1996-2001 VVBX047.
- Dr. Gui's Gentle Guide to COM, Jun. 21, 1995, <http://www.microsoft.com/Com/news/drgui.asp> [retrieved on May 22, 2001], WBX161.
- Open Market Enterprise Content Management and Delivery: Content Center, <URL:<http://www.openmarket.com/cgi-bin/gx.cgi/AppLogic+FTContentServer?pagename=FutureTense/Apps/Xcelerat/Render&c=Artic>.. WBX104.
- Open Market Enterprise Content Management and Delivery: ShopSite <URL:<http://www.openmarket.com/cgi-bin/gx.cgi/AppLogic+FTContentServer?pagename=FutureTense/Apps/Xcelerate/Render&c=Artic>.. pp. 1-2 VVBX110 OpenMarket Enterprise Content Management and Delivery: Transact <URL:<http://www.openmarket.com/cgi-bin/gx>.

US 8,037,158 B2

Page 12

AppLogic+FTContentServer?pagename=FutureTense/Apps/Xcelerate/Render&c=Artic..pp. 1-2 VVBX111Open Market.

Wikipedia, 'A Version History of the Standard: HTMS Version Timeline', http://en.wikipedia.org/wiki/HTML#Version_history_of_the_standard, downloaded on Jun. 17, 2009 WBX258.

Weich, C., "Generic Containers for a Distributed Object Store", Proceedings of the USENIX Conference on ObjectOriented Technologies, Monterey, CA, Jun. 1995WBX150.

Verisign Online Security Solutions, ReedFax Selected Papers, Jun. 22, 1995WBX168.

Verisign Redirection Information, ReedFax Selected Papers, 1995WBX168.

RFC 1065 1988 Network Working Group.

RFC 1318 1992 Network Working Group.

RFC 1516 1993 Network Working Group.

RFC 1155 May 1990 Network Working Group.

RFC 1157 May 1990 Network Working Group.

RFC 1213 Mar. 1991 Network Working Group.

RFC 1156 May 1990 Network Working Group.

Request for Reexamination for Patent 5,778,178.

Tymnet, Wikipedia, the free encyclopedia, <http://en.wikipedia.org/wiki/tymnet>, Oct. 2006.

Cyberman Business Plan: Product Description and Technical Approach, Aug. 26, 1995, Exhibit A.

Cyberman Business Plan: Product Description and Technical Approach, Aug. 26, 1995, Exhibit B.

Cyberman Business Plan: Product Description and Technical Approach, Sep. 1, 1995, Exhibit C.

Cyberman Business Plan: Product Description and Approach, Sep. 1, 1995, Exhibit D.

Cyberman Business Plan: Product Description and Approach, Sep. 1, 1995, Exhibit E.

Cyberman Business Plan: Product Description and Approach, Sep. 1, 1995, Exhibit F.

* cited by examiner

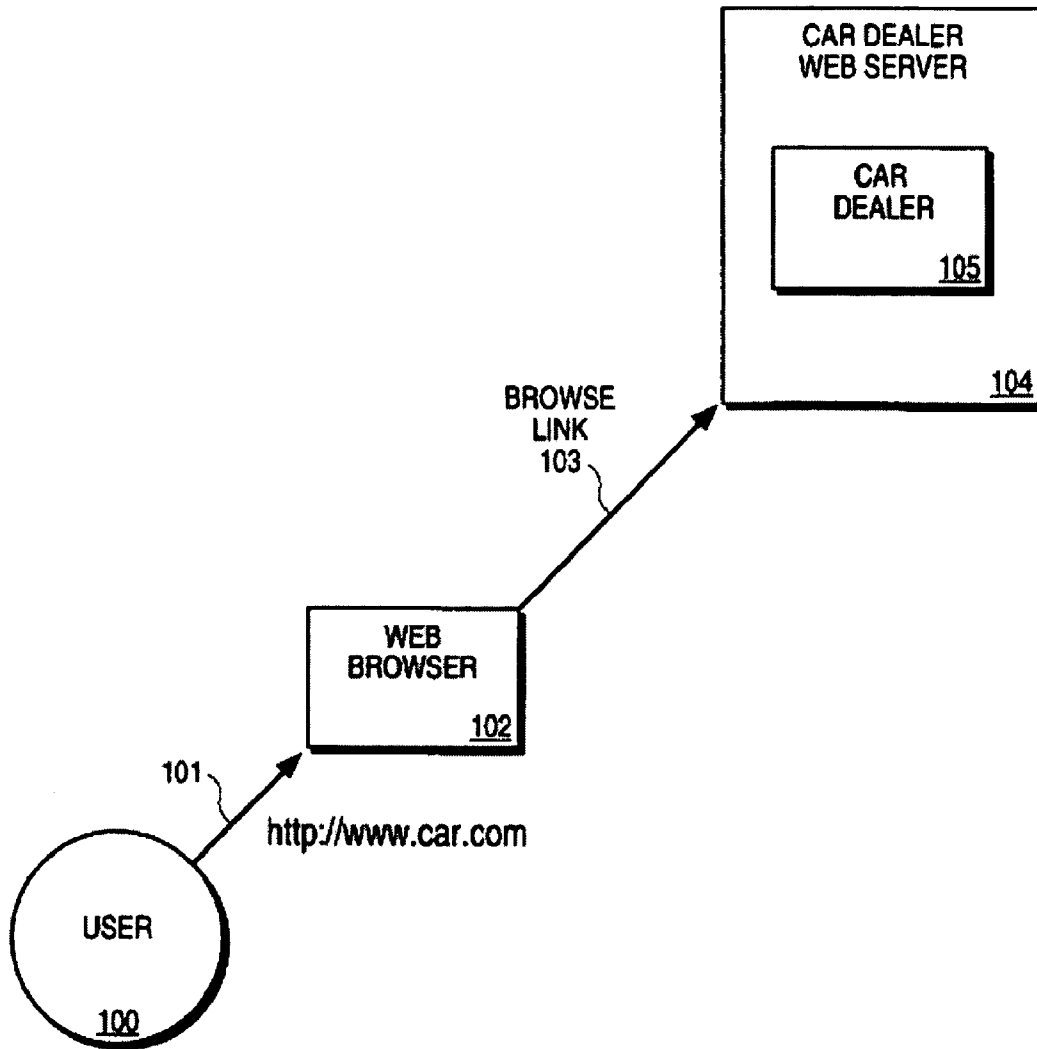

FIG. 1A (PRIOR ART)

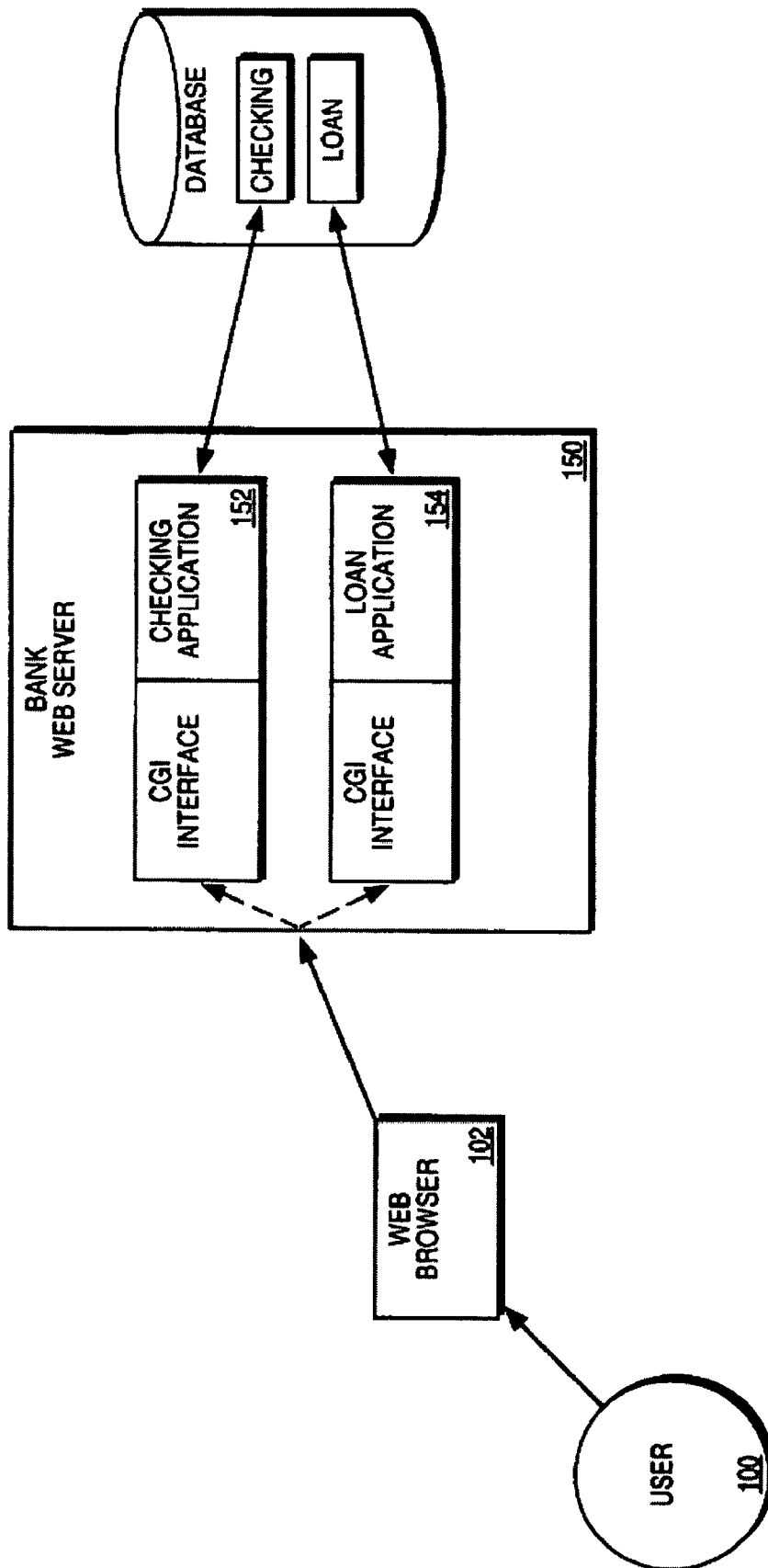

FIG. 1B (PRIOR ART)

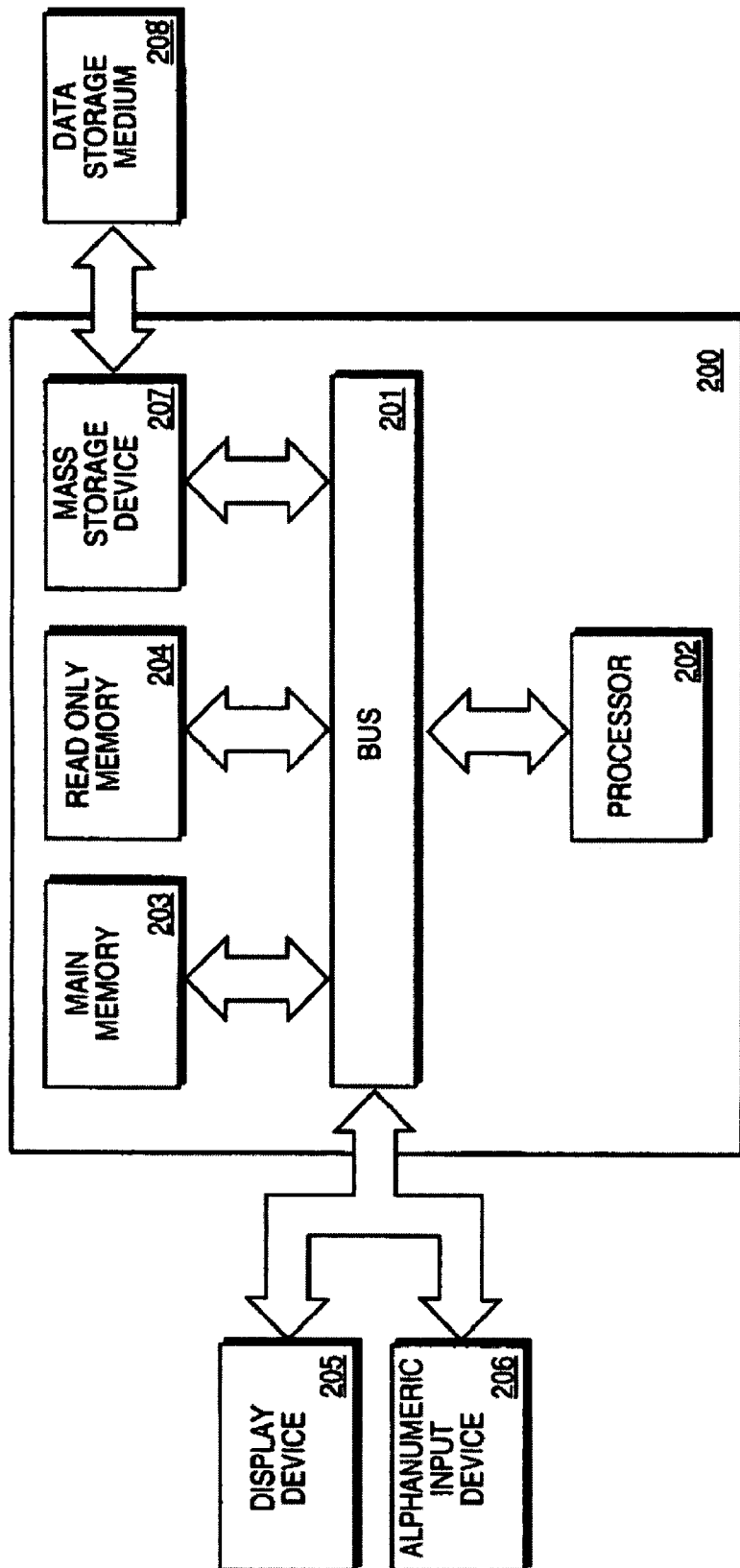

FIG. 2

OSI MODEL
300

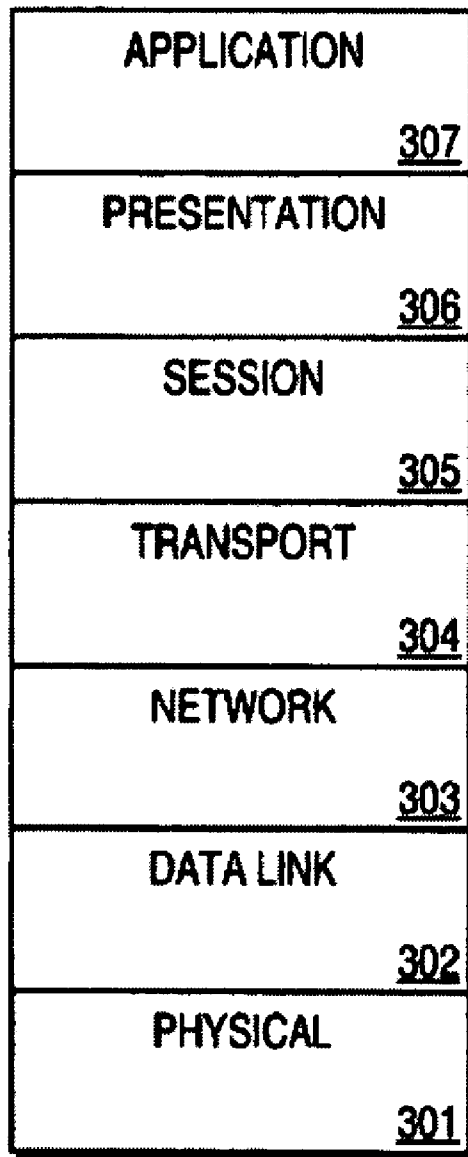

FIG. 3

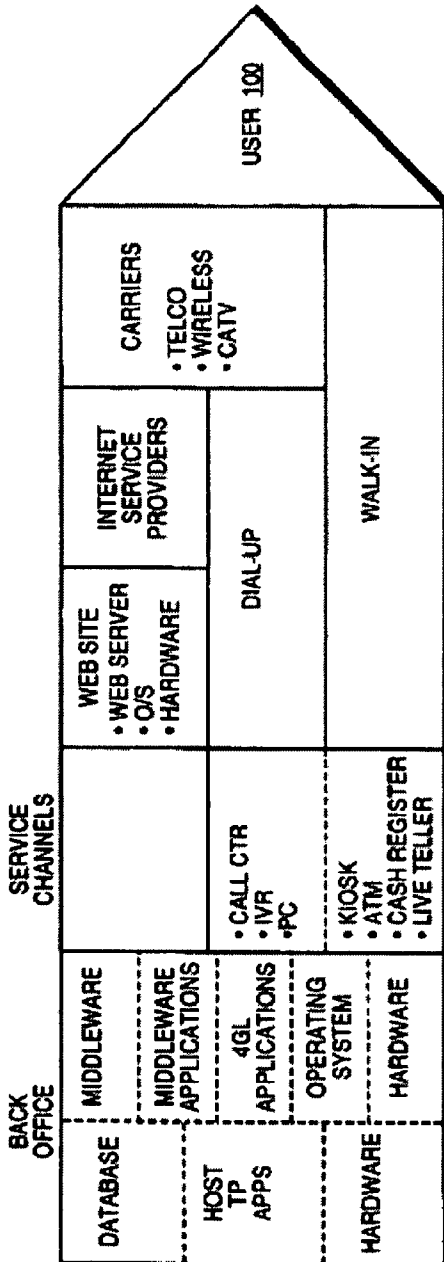

FIG. 4A

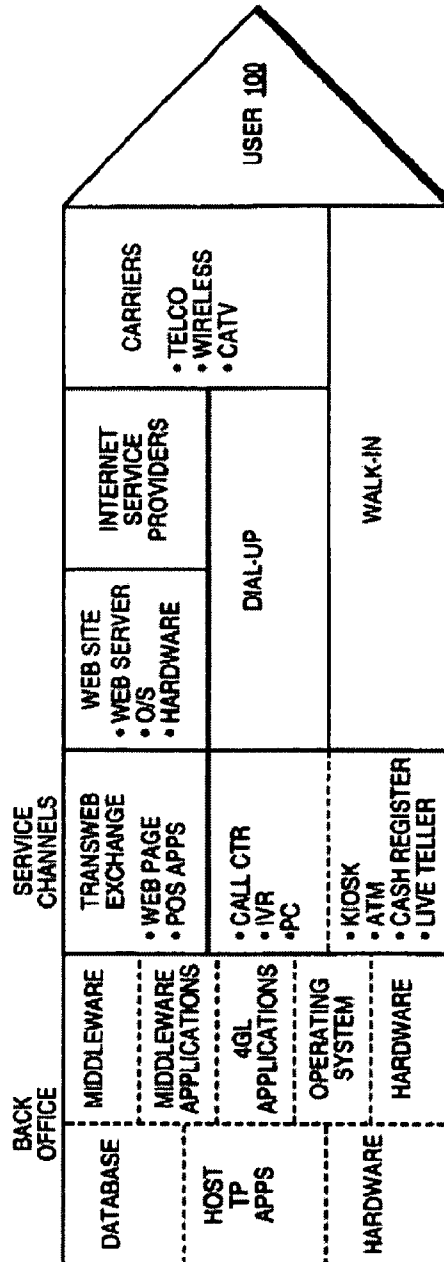

FIG. 4B

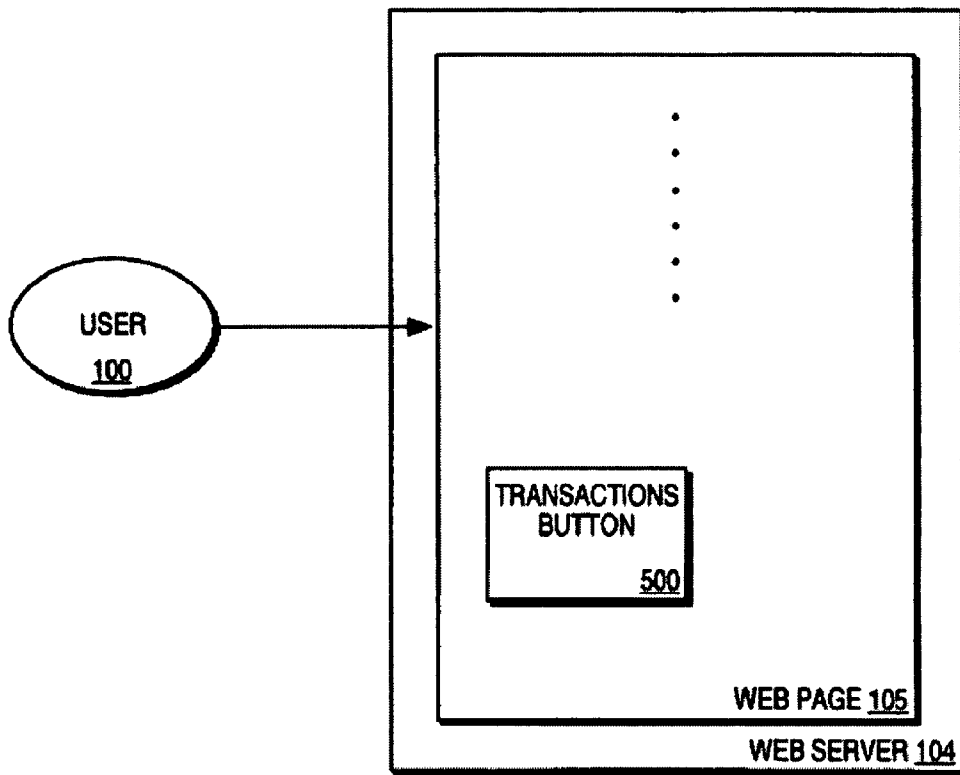

FIG. 5A

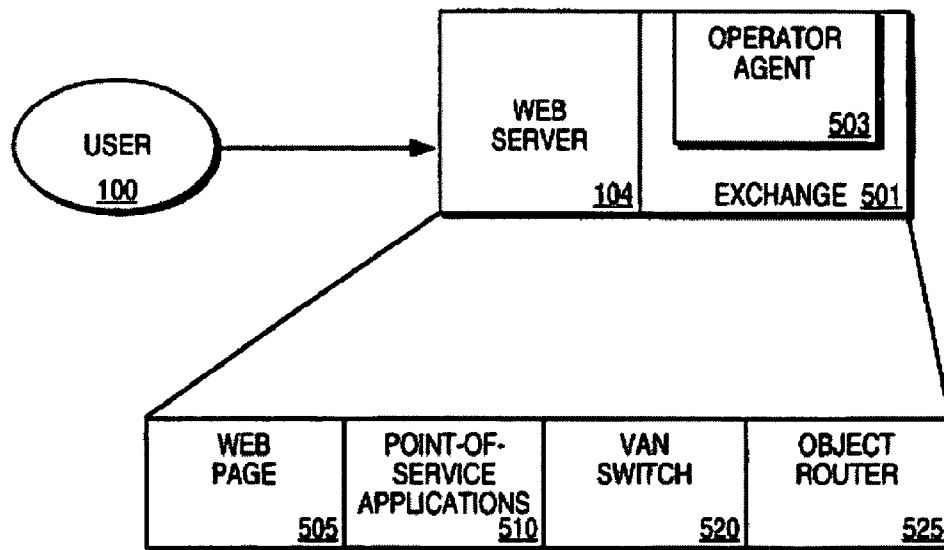

FIG. 5B

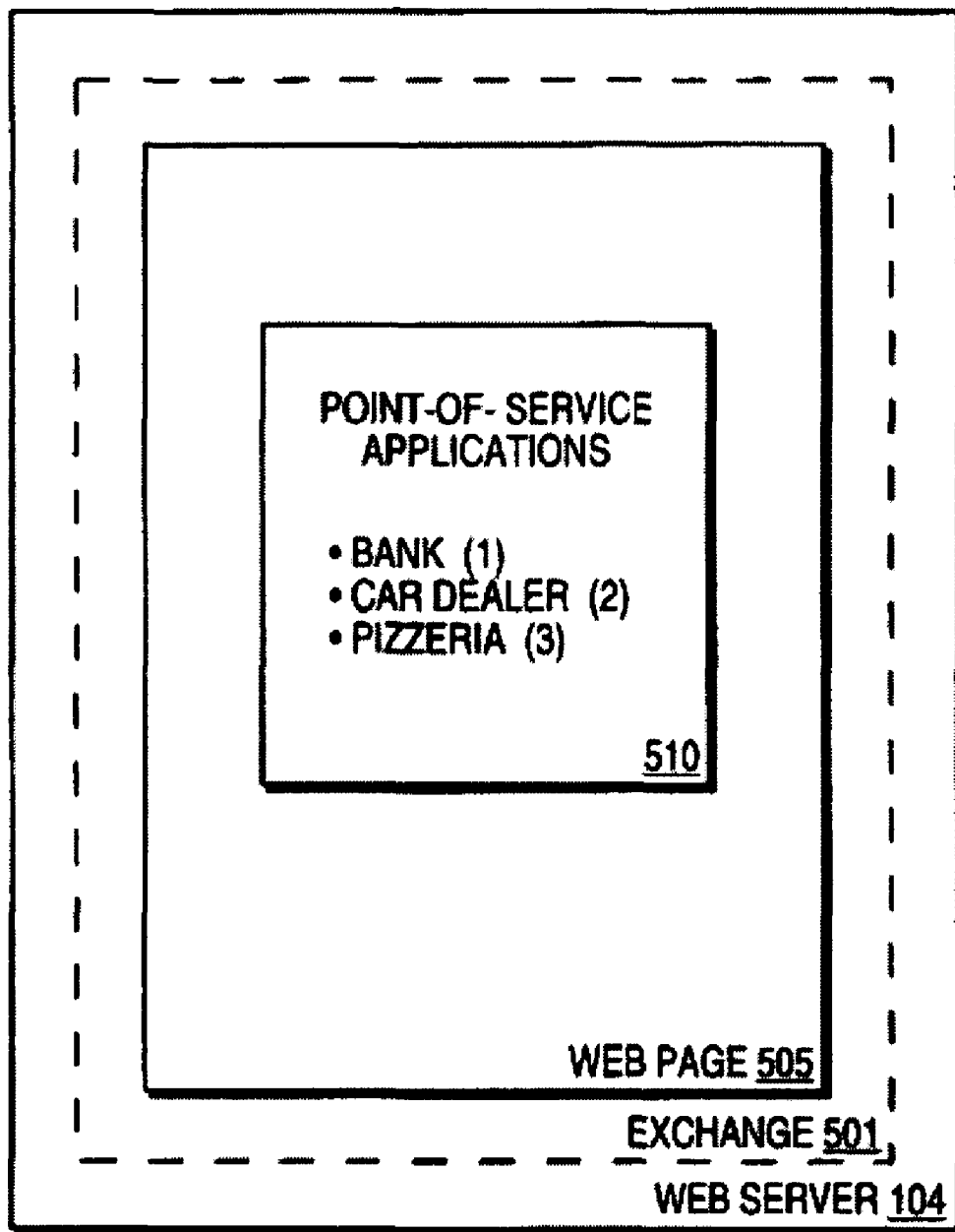

FIG. 5C

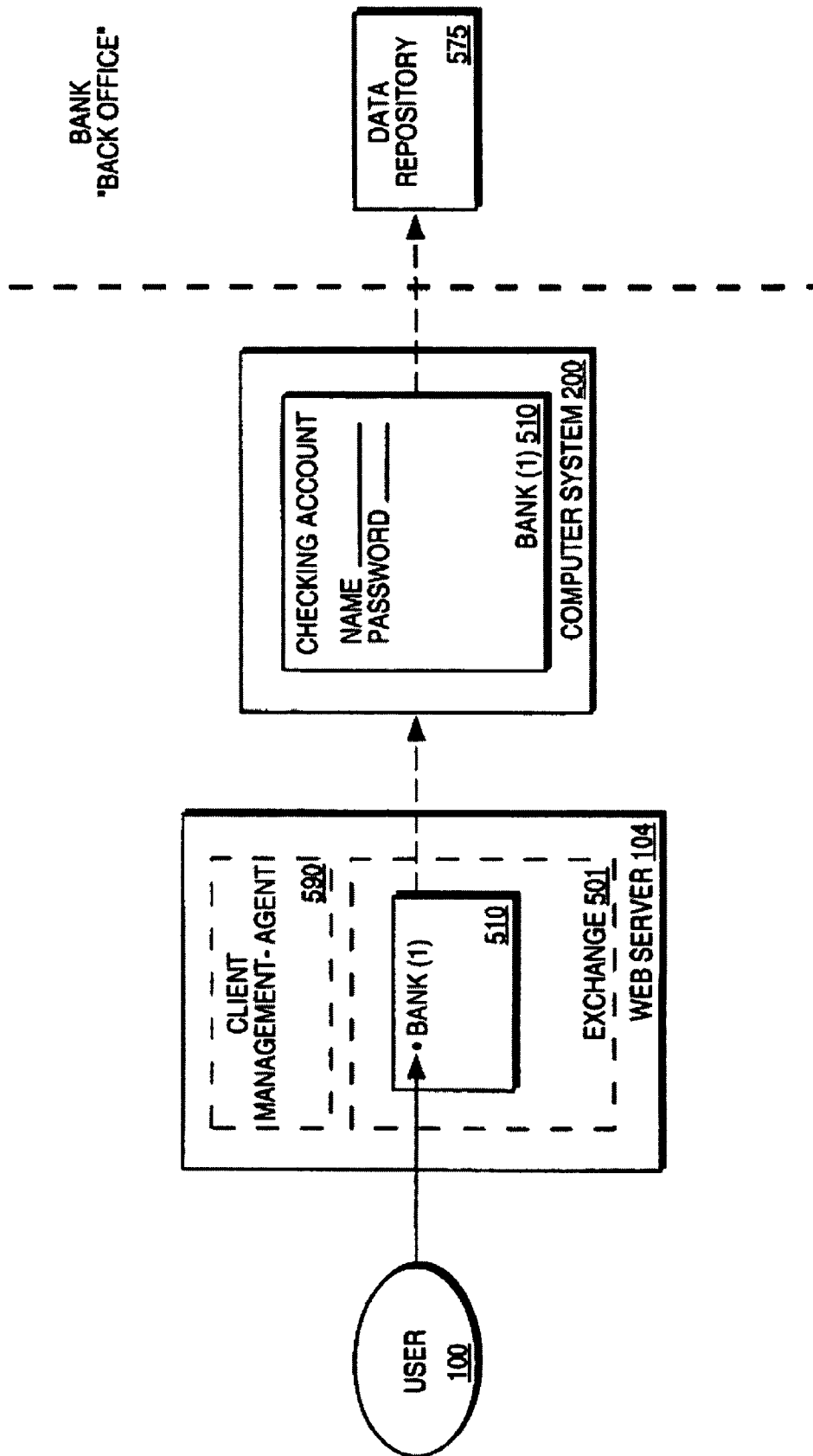

FIG. 5D

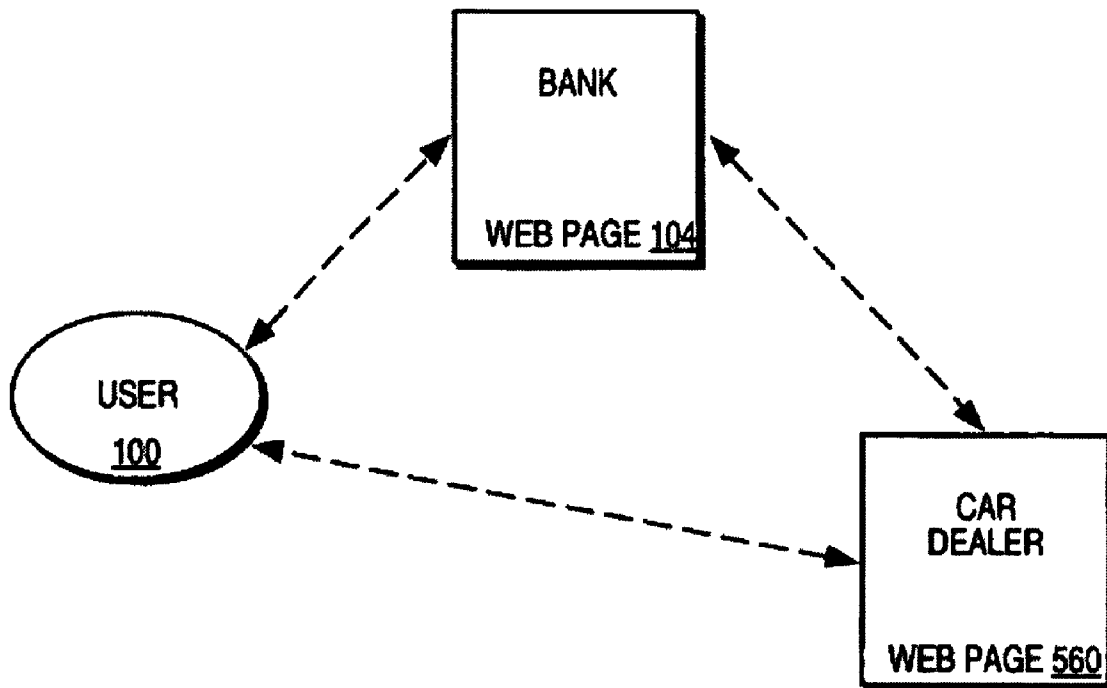

FIG. 5E

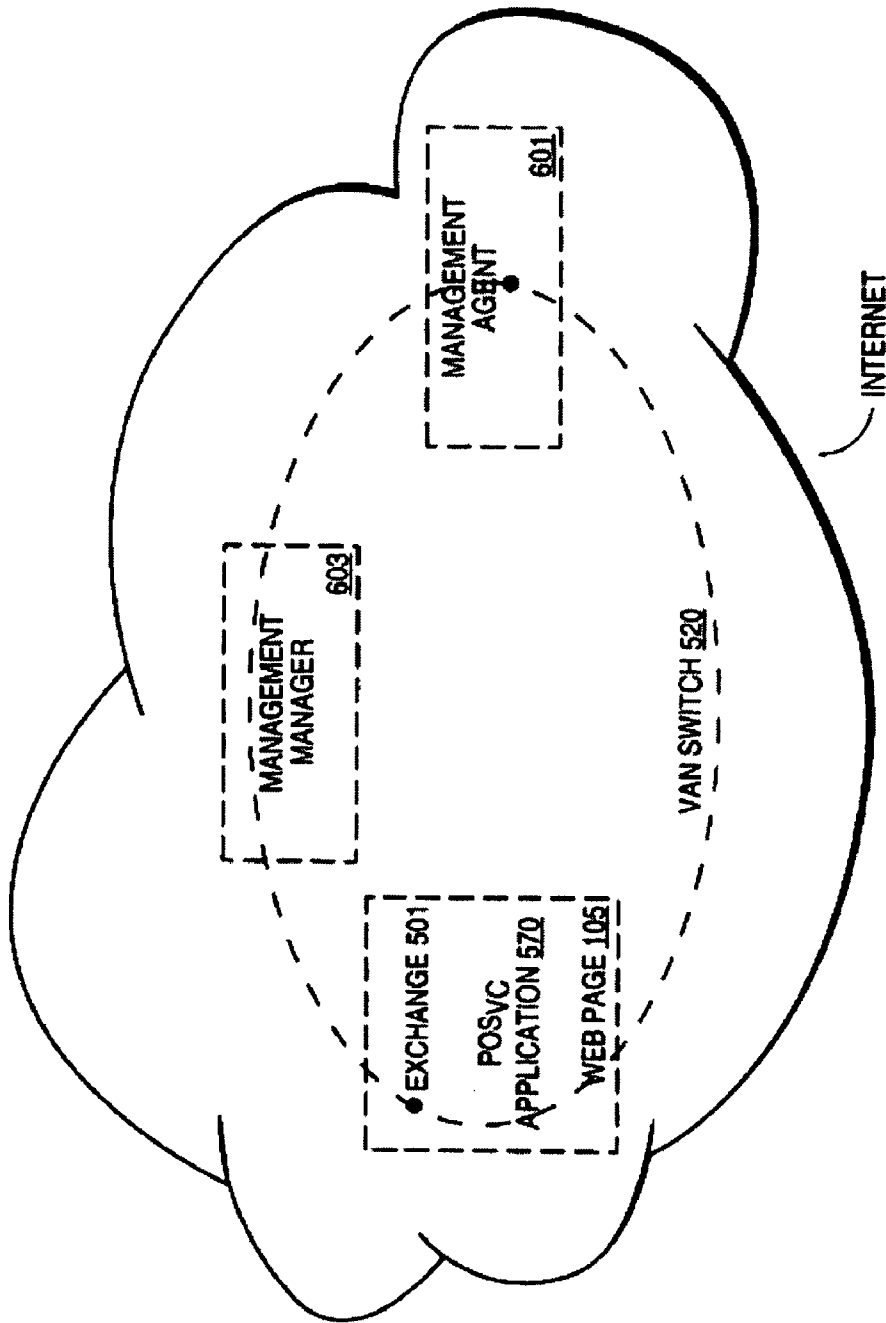

FIG. 6A

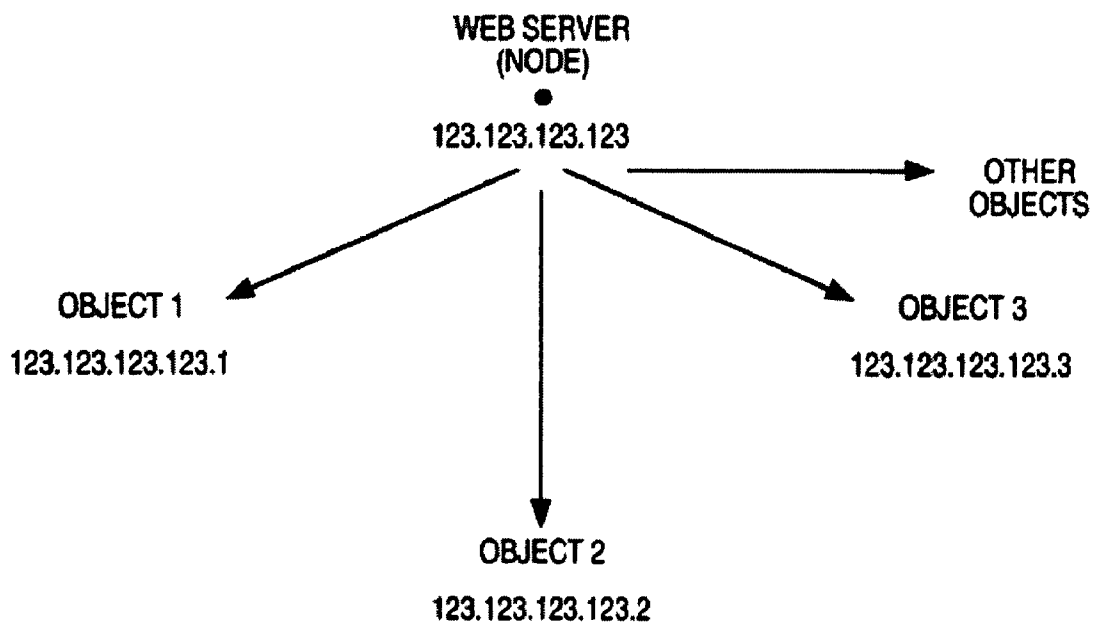

FIG. 6B

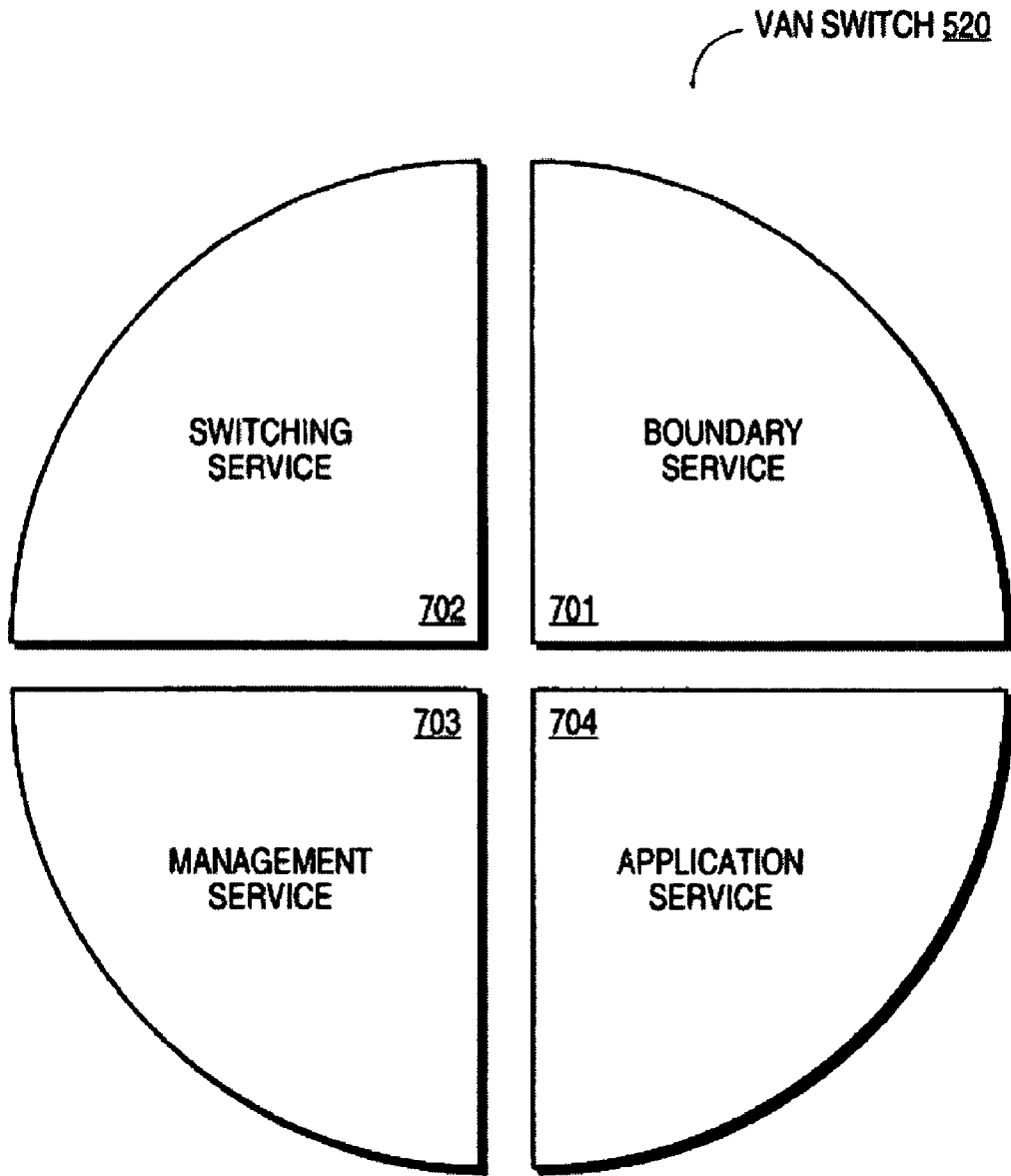

FIG. 7

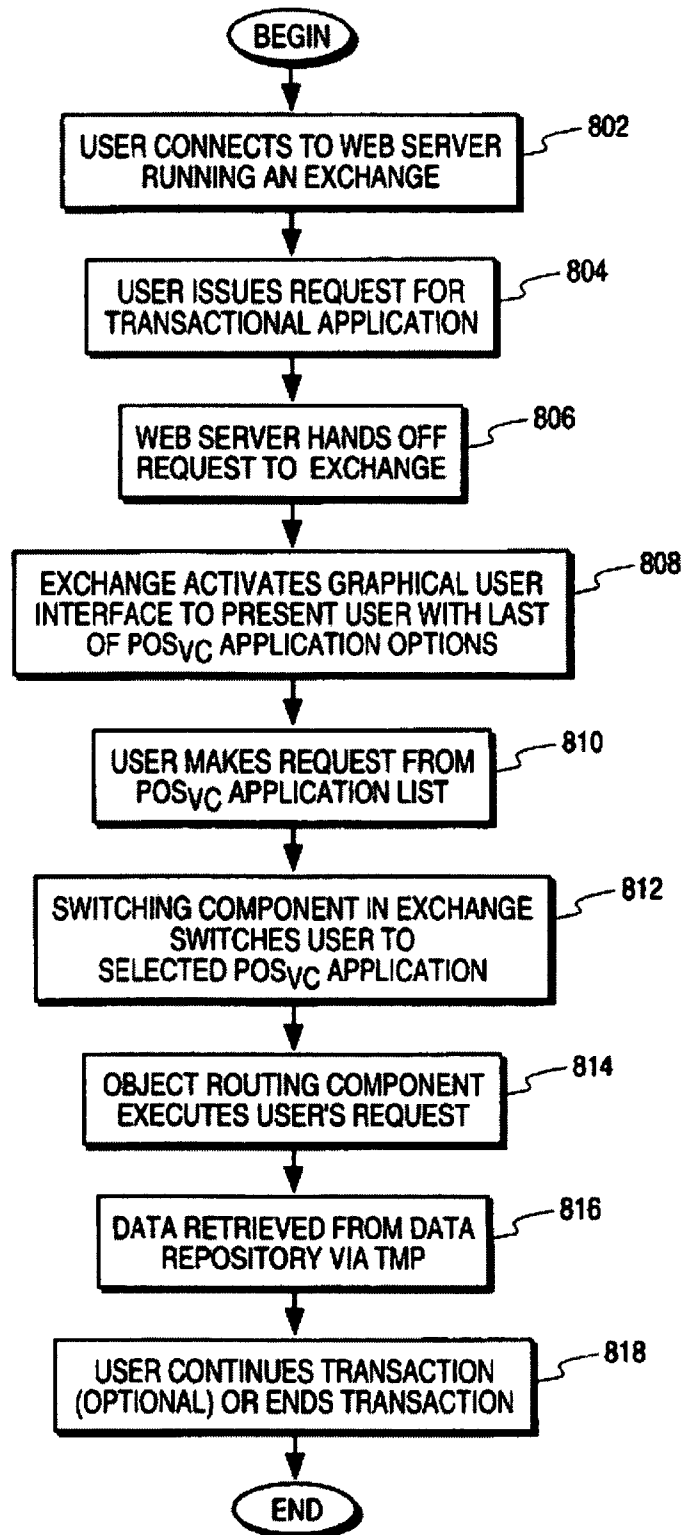

FIG. 8

US 8,037,158 B2

1

MULTIMEDIA TRANSACTIONAL SERVICES

This application is a continuation-in-part of application Ser. No. 09/792,323, filed Feb. 23, 2001, now U.S. Pat. No. 7,340,506, which was a divisional of U.S. patent application Ser. No. 09/296,207 filed Apr. 21, 1999, now U.S. Pat. No. 6,212,556, which was a continuation-in-part of application Ser. No. 08/879,958 filed Jun. 20, 1997, now U.S. Pat. No. 5,987,500, which was a divisional of application Ser. No. 08/700,726 filed Aug. 5, 1996, now U.S. Pat. No. 5,778,178, which was related to and claimed priority from provisional application No. 60/006,634 filed Nov. 13, 1995. This application also claims benefit under 35 U.S.C. 119(e) to U.S. Provisional application Ser. No. 60/006,634 filed Nov. 13, 1995.

The following are related applications: application Ser. No. 09/863,704 filed May 23, 2001 and provisional application 60/206,422 filed May 23, 2000.

BACKGROUND**1. Field of the Invention**

The present invention relates to the area of Internet communications. Specifically, the present invention relates to a method and apparatus for configurable value-added network switching and object routing.

2. Background of the Invention

With the Internet and the World Wide Web ("the Web") evolving rapidly as a viable consumer medium for electronic commerce, new on-line services are emerging to fill the needs of on-line users. An Internet user today can browse on the Web via the use of a Web browser. Web browsers are software interfaces that run on Web clients to allow access to Web servers via a simple user interface. A Web user's capabilities today from a Web browser are, however, extremely limited. The user can perform one-way, browse-only interactions. Additionally, the user has limited "deferred" transactional capabilities, namely electronic mail (e-mail) capabilities. E-mail capabilities are referred to as "deferred transactions" because the consumer's request is not processed until the e-mail is received, read, and the person or system reading the e-mail executes the transaction. This transaction is thus not performed in real-time.

FIG. 1A illustrates typical user interactions on the Web today. User 100 sends out a request from Web browser 102 in the form of a universal resource locator (URL) 101 in the following manner: <http://www.car.com>. URL 101 is processed by Web browser 102 that determines the URL corresponds to car dealer Web page 105, on car dealer Web server 104. Web browser 102 then establishes browse link 103 to car dealer Web page 105. User 100 can browse Web page 105 and select "hot links" to jump to other locations in Web page 105, or to move to other Web pages on the Web. This interaction is typically a browse-only interaction. Under limited circumstances, the user may be able to fill out a form on car dealer Web page 105, and e-mail the form to car dealer Web server 104. This interaction is still strictly a one-way browse mode communications link, with the e-mail providing limited, deferred transactional capabilities.

Under limited circumstances, a user may have access to two-way services on the Web via Common Gateway Interface (CGI) applications. CGI is a standard interface for running external programs on a Web server. It allows Web servers to create documents dynamically when the server receives a request from the Web browser. When the Web server receives a request for a document, the Web server dynamically executes the appropriate CGI script and transmits the output

2

of the execution back to the requesting Web browser. This interaction can thus be termed a "two-way" transaction. It is a severely limited transaction, however, because each CGI application is customized for a particular type of application or service.

For example, as illustrated in FIG. 1B, user 100 may access bank 150's Web server and attempt to perform transactions on checking account 152 and to make a payment on loan account 154. In order for user 100 to access checking account 152 and loan account 154 on the Web, CGI application scripts must be created for each account, as illustrated in FIG. 1B. The bank thus has to create individual scripts for each of its services to offer users access to these services. User 100 can then interact in a limited fashion with these individual applications. Creating and managing individual CGI scripts for each service is not a viable solution for merchants with a large number of services.

As the Web expands and electronic commerce becomes more desirable, the need increases for robust, real-time, bi-directional transactional capabilities on the Web. A true real-time, bi-directional transaction would allow a user to connect to a variety of services on the Web, and perform real-time transactions on those services. For example, although user 100 can browse car dealer Web page 105 today, the user cannot purchase the car, negotiate a car loan or perform other types of real-time, two-way transactions that he can perform with a live salesperson at the car dealership. Ideally, user 100 in FIG. 1A would be able to access car dealer Web page 105, select specific transactions that he desires to perform, such as purchase a car, and perform the purchase in real-time, with two-way interaction capabilities. CGI applications provide user 100 with a limited ability for two-way interaction with car dealer Web page 105, but due to the lack of interaction and management between the car dealer and the bank, he will not be able to obtain a loan and complete the purchase of the car via a CGI application. The ability to complete robust real-time, two-way transactions is thus not truly available on the Web today.

SUMMARY OF THE INVENTION

It is therefore an object of the present invention to provide a method and apparatus for providing real-time, two-way transactional capabilities on the Web. Specifically, one embodiment of the present invention discloses a configurable value-added network switch for enabling real-time transactions on the World Wide Web. The configurable value added network switch comprises means for switching to a transactional application in response to a user specification from a World Wide Web application, means for transmitting a transaction request from the transactional application, and means for processing the transaction request.

According to another aspect of the present invention, a method and apparatus for enabling object routing on the World Wide Web is disclosed. The method for enabling object routing comprises the steps of creating a virtual information store containing information entries and attributes, associating each of the information entries and the attributes with an object identity, and assigning a unique network address to each of the object identities.

Other objects, features and advantages of the present invention will be apparent from the accompanying drawings and from the detailed description.

BRIEF DESCRIPTION OF THE DRAWINGS

The features and advantages of the present invention will be apparent from the accompanying drawings and from the detailed description of the present invention as set forth below.

US 8,037,158 B2

3

FIG. 1A is an illustration of a current user's browse capabilities on the Web via a Web browser.

FIG. 1B is an illustration of a current user's capabilities to perform limited transactions on the Web via CGI applications.

FIG. 2 illustrates a typical computer system on which the present invention may be utilized.

FIG. 3 illustrates the Open Systems Interconnection (OSI) Model.

FIG. 4A illustrates conceptually the user value chain as it exists today.

FIG. 4B illustrates one embodiment of the present invention.

FIG. 5A illustrates a user accessing a Web server including one embodiment of the present invention.

FIG. 5B illustrates the exchange component according to one embodiment of the present invention.

FIG. 5C illustrates an example of a point-of-service (POSvc) application list.

FIG. 5D illustrates a user selecting a bank POSvc application from the POSvc application list.

FIG. 5E illustrates a three-way transaction according to one embodiment of the present invention.

FIG. 6A illustrates a value-added network (VAN) switch.

FIG. 6B illustrates the hierarchical addressing tree structure of the networked objects in DOLSIBs.

FIG. 7 illustrates conceptually the layered architecture of a VAN switch.

FIG. 8 is a flow diagram illustrating one embodiment of the present invention.

DETAILED DESCRIPTION OF THE PREFERRED EMBODIMENT

The present invention relates to a method and apparatus for configurable value-added network switching and object routing and management. "Web browser" as used in the context of the present specification includes conventional Web browsers such as NCSA Mosaic™ from NCSA and Netscape Mosaic™ from Netscape™. The present invention is independent of the Web browser being utilized and the user can use any Web browser, without modifications to the Web browser. In the following detailed description, numerous specific details are set forth in order to provide a thorough understanding of the present invention. It will be apparent to one of ordinary skill in the art, however, that these specific details need not be used to practice the present invention. In other instances, well-known structures, interfaces and processes have not been shown in detail in order not to unnecessarily obscure the present invention.

FIG. 2 illustrates a typical computer system 200 in which the present invention operates. The preferred embodiment of the present invention is implemented on an IBM™ Personal Computer manufactured by IBM Corporation of Armonk, N.Y. Alternate embodiments may be implemented on a Macintosh™ computer manufactured by Apple™ Computer, Incorporated of Cupertino, Calif. It will be apparent to those of ordinary skill in the art that other alternative computer system architectures may also be employed.

In general, such computer systems as illustrated by FIG. 2 comprise a bus 201 for communicating information, a processor 202 coupled with the bus 201 for processing information, main memory 203 coupled with the bus 201 for storing information and instructions for the processor 202, a read-only memory 204 coupled with the bus 201 for storing static information and instructions for the processor 202, a display device 205 coupled with the bus 201 for displaying informa-

4

tion for a computer user, an input device 206 coupled with the bus 201 for communicating information and command selections to the processor 202, and a mass storage device 207, such as a magnetic disk and associated disk drive, coupled with the bus 201 for storing information and instructions. A data storage medium 208 containing digital information is configured to operate with mass storage device 207 to allow processor 202 access to the digital information on data storage medium 208 via bus 201.

Processor 202 may be any of a wide variety of general purpose processors or microprocessors such as the Pentium™ microprocessor manufactured by Intel™ Corporation or the Motorola™ 68040 or Power PC™ brand microprocessor manufactured by Motorola™ Corporation. It will be apparent to those of ordinary skill in the art, however, that other varieties of processors may also be used in a particular computer system. Display device 205 may be a liquid crystal device, cathode ray tube (CRT), or other suitable display device. Mass storage device 207 may be a conventional hard disk drive, floppy disk drive, CD-ROM drive, or other magnetic or optical data storage device for reading and writing information stored on a hard disk, a floppy disk, a CD-ROM a magnetic tape, or other magnetic or optical data storage medium. Data storage medium 208 may be a hard disk, a floppy disk, a CD-ROM, a magnetic tape, or other magnetic or optical data storage medium.

In general, processor 202 retrieves processing instructions and data from a data storage medium 208 using mass storage device 207 and downloads this information into random access memory 203 for execution. Processor 202, then executes an instruction stream from random access memory 203 or read-only memory 204. Command selections and information input at input device 206 are used to direct the flow of instructions executed by processor 202. Equivalent input device 206 may also be a pointing device such as a conventional mouse or trackball device. The results of this processing execution are then displayed on display device 205.

The preferred embodiment of the present invention is implemented as a software module, which may be executed on a computer system such as computer system 200 in a conventional manner. Using well known techniques, the application software of the preferred embodiment is stored on data storage medium 208 and subsequently loaded into and executed within computer system 200. Once initiated, the software of the preferred embodiment operates in the manner described below.

FIG. 3 illustrates the Open Systems Interconnection (OSI) reference model. OSI Model 300 is an international standard that provides a common basis for the coordination of standards development, for the purpose of systems interconnection. The present invention is implemented to function as a routing switch within the "application layer" of the OSI model. The model defines seven layers, with each layer communicating with its peer layer in another node through the use of a protocol. Physical layer 301 is the lowest layer, with responsibility to transmit unstructured bits across a link. Data link layer 302 is the next layer above physical layer 301. Data link layer 302 transmits chunks across the link and deals with problems like checksumming to detect data corruption, orderly coordination of the use of shared media and addressing when multiple systems are reachable. Network bridges operate within data link layer 302.

Network layer 303 enables any pair of systems in the network to communicate with each other. Network layer 303 contains hardware units such as routers, that handle routing, packet fragmentation and reassembly of packets. Transport

US 8,037,158 B2

5

layer **304** establishes a reliable communication stream between a pair of systems, dealing with errors such as lost packets, duplicate packets, packet reordering and fragmentation. Session layer **305** offers services above the simple communication stream provided by transport layer **304**. These services include dialog control and chaining. Presentation layer **306** provides a means by which OSI compliant applications can agree on representations for data. Finally, application layer **307** includes services such as file transfer, access and management services (FTAM), electronic mail and virtual terminal (VT) services. Application layer **307** provides a means for application programs to access the OSI environment. As described above, the present invention is implemented to function as a routing switch in application layer **307**. Application layer routing creates an open channel for the management, and the selective flow of data from remote databases on a network.

A. Overview

FIG. **4A** illustrates conceptually the user value chain as it exists today. The user value chain in FIG. **4A** depicts the types of transactions that are performed today, and the channels through which the transactions are performed. A “transaction” for the purposes of the present invention includes any type of commercial or other type of interaction that a user may want to perform. Examples of transactions include a deposit into a bank account, a request for a loan from a bank, a purchase of a car from a car dealership or a purchase of a car with financing from a bank. A large variety of other transactions are also possible.

A typical user transaction today may involve user **100** walking into a bank or driving up to a teller machine, and interacting with a live bank teller, or automated teller machine (ATM) software applications. Alternatively, user **100** can perform the same transaction by using a personal computer (PC), activating application software on his PC to access his bank account, and dialing into the bank via a modem line. If user **100** is a Web user, however, there is no current mechanism for performing a robust, real-time transaction with the bank, as illustrated in FIG. **4A**. CGI scripts provide only limited two-way capabilities, as described above. Thus, due to this lack of a robust mechanism by which real-time Web transactions can be performed, the bank is unable to be a true “Web merchant,” namely a merchant capable of providing complete transactional services on the Web.

According to one embodiment of the present invention, as illustrated in FIG. **4B**, each merchant that desires to be a Web merchant can provide real-time transactional capabilities to users who desire to access the merchants’ services via the Web. This embodiment includes a service network running on top of a facilities network, namely the Internet, the Web or e-mail networks. For the purposes of this application, users are described as utilizing PC’s to access the Web via Web server “switching” sites. (Switching is described in more detail below). Users may also utilize other personal devices such as network computers or cellular devices to access the merchants’ services via appropriate switching sites. These switching sites include non-Web network computer sites and cellular provider sites. Five components interact to provide this service network functionality, namely an exchange, an operator agent, a management agent, a management manager and a graphical user interface. All five components are described in more detail below.

As illustrated in FIG. **5A**, user **100** accesses Web server **104**. Having accessed Web server **104**, user **100** can decide that he desires to perform real-time transactions. When Web server **104** receives user **100**’s indication that he desires to perform real-time transactions, the request is handed over to

6

an exchange component. Thus, from Web page **105**, for example, user **100** can select button **500**, entitled “Transactions” and Web server **104** hands user **100**’s request over to the exchange component. The button and the title can be replaced by any mechanism that can instruct a Web server to hand over the consumer’s request to the exchange component.

FIG. **5B** illustrates exchange **501**. Exchange **501** comprises Web page **505** and point-of-service (POSvc) applications **510**. Exchange **501** also conceptually includes a switching component and an object routing component (described in more detail below). POSvc applications **510** are transactional applications, namely applications that are designed to incorporate and take advantage of the capabilities provided by the present invention. Although exchange **501** is depicted as residing on Web server **104**, the exchange can also reside on a separate computer system that resides on the Internet and has an Internet address. Exchange **501** may also include operator agent **503** that interacts with a management manager (described in more detail below). Exchange **501** creates and allows for the management (or distributed control) of a service network, operating within the boundaries of an IP-based facilities network. Thus, exchange **501** and a management agent component, described in more detail below, under the headings “VAN Switch and Object Routing,” together perform the switching, object routing, application and service management functions according to one embodiment of the present invention.

Exchange **501** processes the consumer’s request and displays an exchange Web page **505** that includes a list of POSvc applications **510** accessible by exchange **501**. A POSvc application is an application that can execute the type of transaction that the user may be interested in performing. The POSvc list is displayed via the graphical user interface component. One embodiment of the present invention supports HyperText Markup Language as the graphical user interface component. Virtual Reality Markup Language and Java™ are also supported by this embodiment. A variety of other graphical user interface standards can also be utilized to implement the graphical user interface.

An example of a POSvc application list is illustrated in FIG. **5C**. User **100** can thus select from POSvc applications Bank **510(1)**, Car Dealer **510(2)** or Pizzeria **510(3)**. Numerous other POSvc applications can also be included in this selection. If user **100** desires to perform a number of banking transactions, and selects the Bank application, a Bank POSvc application will be activated and presented to user **100**, as illustrated in FIG. **5D**. For the purposes of illustration, exchange **501** in FIG. **5D** is shown as running on a different computer system (Web server **104**) from the computer systems of the Web merchants running POSvc applications (computer system **200**). Exchange **501** may, however, also be on the same computer system as one or more of the computer systems of the Web merchants.

Once Bank POSvc application **510** has been activated, user **100** will be able to connect to Bank services and utilize the application to perform banking transactions, thus accessing data from a host or data repository **575** in the Bank “Back Office.” The Bank Back Office comprises legacy databases and other data repositories that are utilized by the Bank to store its data. This connection between user **100** and Bank services is managed by exchange **501**. As illustrated in FIG. **5D**, once the connection is made between Bank POSvc application **510(1)**, for example, and Bank services, an operator agent on Web server **104** may be activated to ensure the availability of distributed functions and capabilities.

US 8,037,158 B2

7

Each Web merchant may choose the types of services that it would like to offer its clients. In this example, if Bank decided to include in their POSvc application access to checking and savings accounts, user **100** will be able to perform real-time transactions against his checking and savings accounts. Thus, if user **100** moves \$500 from his checking account into his savings account, the transaction will be performed in real-time, in the same manner the transaction would have been performed by a live teller at the bank or an ATM machine. Therefore, unlike his prior access to his account, user **100** now has the capability to do more than browse his bank account. The ability to perform these types of robust, real-time transactions from a Web client is a significant aspect of the present invention.

Bank can also decide to provide other types of services in POSvc application **510(1)**. For example, Bank may agree with Car dealership to allow Bank customers to purchase a car from that dealer, request a car loan from Bank, and have the entire transaction performed on the Web, as illustrated in FIG. **5E**. In this instance, the transactions are not merely two-way, between the user and Bank, but three-way, amongst the consumer, Bank and Car dealership. According to one aspect of the present invention, this three-way transaction can be expanded to n-way transactions, where n represents a predetermined number of merchants or other service providers who have agreed to cooperate to provide services to users. The present invention therefore allows for “any-to-any” communication and transactions on the Web, thus facilitating a large, flexible variety of robust, real-time transactions on the Web.

Finally, Bank may also decide to provide intra-merchant or intra-bank services, together with the inter-merchant services described above. For example, if Bank creates a POSvc application for use by the Bank Payroll department, Bank may provide its own employees with a means for submitting timecards for payroll processing by the Bank’s Human Resources (HR) Department. An employee selects the Bank HR POSvc application, and submits his timecard. The employee’s timecard is processed by accessing the employee’s payroll information, stored in the Bank’s Back Office. The transaction is thus processed in real-time, and the employee receives his paycheck immediately.

B. Van Switching and Object Routing

As described above, exchange **501** and management agent **601**, illustrated in FIG. **6A**, together constitute a value-added network (VAN) switch. These two elements may take on different roles as necessary, including peer-to-peer, client-server or master-slave roles. Management manager **603** is illustrated as residing on a separate computer system on the Internet. Management manager **603** can, however, also reside on the same machine as exchange **501**. Management manager **603** interacts with the operator agent **503** residing on exchange **501**.

VAN switch **520** provides multi-protocol object routing, depending upon the specific VAN services chosen. This multi-protocol object routing is provided via a proprietary protocol, TransWeb™ Management Protocol (TMP). TMP incorporates the same security features as the traditional Simple Network Management Protocol, SNMP. It also allows for the integration of other traditional security mechanisms, including RSA security mechanisms.

One embodiment of the present invention utilizes TMP and distributed on-line service information bases (DOLSIBs) to perform object routing. Alternatively, TMP can incorporate s-HTTP, Java™, the WinSock API or ORB with DOLSIBs to perform object routing. DOLSIBs are virtual information stores optimized for networking. All information entries and attributes in a DOLSIB virtual information store are associ-

8

ated with a networked object identity. The networked object identity identifies the information entries and attributes in the DOLSIB as individual networked objects, and each networked object is assigned an Internet address. The Internet address is assigned based on the IP address of the node at which the networked object resides.

For example, in FIG. **5A**, Web server **104** is a node on the Internet, with an IP address. All networked object associated with Web server **104** will therefore be assigned an Internet address based on the Web server **104**’s IP address. These networked objects thus “branch” from the node, creating a hierarchical tree structure. The Internet address for each networked object in the tree essentially establishes the individual object as an “IP-reachable” or accessible node on the Internet. TMP utilizes this Internet address to uniquely identify and access the object from the DOLSIB. FIG. **6B** illustrates an example of this hierarchical addressing tree structure.

Each object in the DOLSIB has a name, a syntax and an encoding. The name is an administratively assigned object ID specifying an object type. The object type together with the object instance serves to uniquely identify a specific instantiation of the object. For example, if object **610** is information about models of cars, then one instance of that object would provide user **100** with information about a specific model of the car while another instance would provide information about a different model of the car. The syntax of an object type defines the abstract data structure corresponding to that object type. Encoding of objects defines how the object is represented by the object type syntax while being transmitted over the network.

C. Management and Administration

As described above, exchange **501** and management agent **601** together constitute a VAN switch. FIG. **7** illustrates conceptually the layered architecture of VAN switch **520**. Specifically, boundary service **701** provides the interfaces between VAN switch **520**, the Internet and the Web, and multi-media end user devices such as PCs, televisions or telephones. Boundary service **701** also provides the interface to the on-line service provider. A user can connect to a local application, namely one accessible via a local VAN switch, or be routed or “switched” to an application accessible via a remote VAN switch.

Switching service **702** is an OSI application layer switch. Switching service **702** thus represents the core of the VAN switch. It performs a number of tasks including the routing of user connections to remote VAN switches, described in the paragraph above, multiplexing and prioritization of requests, and flow control. Switching service **702** also facilitates open systems’ connectivity with both the Internet (a public switched network) and private networks including back office networks, such as banking networks. Interconnected application layer switches form the application network backbone. These switches are one significant aspect of the present invention.

Management service **703** contains tools such as Information Management Services (IMS) and application Network Management Services (NMS). These tools are used by the end users to manage network resources, including VAN switches. Management service **703** also provides applications that perform Operations, Administration, Maintenance & Provisioning (OAM&P) functions. These OAM&P functions include security management, fault management, configuration management, performance management and billing management. Providing OAM&P functions for applications in this manner is another significant aspect of the present invention.

9

Finally, application service 704 contains application programs that deliver customer services. Application service 704 includes POSvc applications such as Bank POSvc described above, and illustrated in FIG. 6A. Other examples of VAN services include multi-media messaging, archival/retrieval management, directory services, data staging, conferencing, financial services, home banking, risk management and a variety of other vertical services. Each VAN service is designed to meet a particular set of requirements related to performance, reliability, maintenance and ability to handle expected traffic volume. Depending on the type of service, the characteristics of the network elements will differ. VAN service 704 provides a number of functions including communications services for both management and end users of the network and control for the user over the user's environment.

FIG. 8 is a flow diagram illustrating one embodiment of the present invention. A user connects to a Web server running an exchange component in step 802. In step 804, the user issues a request for a transactional application, and the web server hands off the request to an exchange in step 806. The exchange activates a graphical user interface to present user with a list of POSvc application options in step 808. In step 810, the user makes a selection from the POSvc application list. In step 812, the switching component in the exchange switches the user to the selected POSvc application, and in step 814, the object routing component executes the user's request. Data is retrieved from the appropriate data repository via TMP in step 816, and finally, the user may optionally continue the transaction in step 818 or end the transaction.

Thus, a configurable value-added network switching and object routing method and apparatus is disclosed. These specific arrangements and methods described herein are merely illustrative of the principles of the present invention. Numerous modifications in form and detail may be made by those of ordinary skill in the art without departing from the scope of the present invention. Although this invention has been shown in relation to a particular preferred embodiment, it should not be considered so limited. Rather, the present invention is limited only by the scope of the appended claims.

The invention claimed is:

1. A method for performing a real time Web transaction from a Web application over a digital network atop the Web, the method comprising:

providing a Web page for display on a computer system coupled to an input device;

10

providing a point-of-service application as a selection within the Web page, wherein the point-of-service application provides access to both a checking and savings account, the point-of-service application operating in a service network atop the World Wide Web; accepting a first signal from the Web user input device to select the point-of-service application; accepting subsequent signals from the Web user input device; and transferring funds from the checking account to the savings account in real-time utilizing a routed transactional data structure that is both complete and non-deferred, in addition to being specific to the point-of-service application, the routing occurring in response to the subsequent signals.

2. The method of claim 1, wherein an exchange over the Web is used to complete the transfer of funds in a Web application.

3. The method of claim 1, wherein a management agent is used to complete the transfer of funds in a Web application.

4. The method of claim 1, wherein object routing is used to complete the transfer of funds in a Web application.

5. The method of claim 4, wherein the object routing includes the use of a distributed on-line service information bases.

6. The method of claim 1, wherein a virtual information store is used to complete the transfer of funds.

7. The method of claim 6, wherein the virtual information store includes a networked object specific to a Web application in a Web transaction.

8. The method of claim 7, wherein the networked object is the object identity in a Web transaction connecting from a Web application on a Web page to a transactional application executing anywhere across the Web.

9. The method of claim 1, wherein the Web transaction is a loan requested from a lender across the Web from a Web application.

10. The method of claim 1, wherein the Web transaction is a vehicle purchased with bank financing across the Web from a Web application.

11. The method of claim 1, wherein the Web transaction is accessing an account across the Web from a Web application.

* * * * *

EXHIBIT C



US008108492B2

(12) **United States Patent**
Arunachalam

(10) **Patent No.:** **US 8,108,492 B2**
(45) **Date of Patent:** **Jan. 31, 2012**

(54) **WEB APPLICATION NETWORK PORTAL**

(76) Inventor: **Lakshmi Arunachalam**, Menlo Park, CA (US)

(*) Notice: Subject to any disclaimer, the term of this patent is extended or adjusted under 35 U.S.C. 154(b) by 0 days.

(21) Appl. No.: **12/628,060**

(22) Filed: **Nov. 30, 2009**

(65) **Prior Publication Data**

US 2010/0306102 A1 Dec. 2, 2010

Related U.S. Application Data

(60) Division of application No. 11/980,185, filed on Oct. 30, 2007, now Pat. No. 8,037,158, which is a continuation-in-part of application No. 09/792,323, filed on Feb. 23, 2001, now Pat. No. 7,340,506, which is a division of application No. 09/296,207, filed on Apr. 21, 1999, now Pat. No. 6,212,556, which is a continuation-in-part of application No. 08/879,958, filed on Jun. 20, 1997, now Pat. No. 5,987,500, which is a division of application No. 08/700,726, filed on Aug. 5, 1996, now Pat. No. 5,778,178.

(60) Provisional application No. 60/006,634, filed on Nov. 13, 1995.

(51) **Int. Cl.**
G06F 13/00 (2006.01)

(52) **U.S. Cl.** **709/219**; 709/225; 709/228

(58) **Field of Classification Search** 709/217, 709/219, 223, 224, 225, 227, 229
See application file for complete search history.

(56) **References Cited**

U.S. PATENT DOCUMENTS

4,829,372 A 5/1989 McCalley et al.
4,851,988 A 7/1989 Trottier et al.

4,984,155 A 1/1991 Geler et al.
5,125,091 A 6/1992 Staas, Jr. et al.
5,148,474 A 9/1992 Haralambopoulos et al.
5,159,632 A 10/1992 Crandall
5,231,566 A 7/1993 Blutinger et al.
5,239,662 A 8/1993 Danielson et al.
5,285,383 A 2/1994 Lindsey et al.
5,297,249 A 3/1994 Bernstein et al.
5,329,589 A 7/1994 Fraser et al.
5,329,619 A 7/1994 Page et al.
5,347,632 A 9/1994 Filepp et al.
5,367,635 A 11/1994 Bauer et al.
5,383,113 A 1/1995 Kight et al.
5,404,523 A 4/1995 Dellafera et al.

(Continued)

FOREIGN PATENT DOCUMENTS

WO WO 97/18515 A1 5/1997
WO WO 00/63781 A1 10/2000

OTHER PUBLICATIONS

U.S. Appl. No. 12/268,060, filed Nov. 30, 2009, Arunachalam.
U.S. Appl. No. 12/628,066, filed Nov. 30, 2009, Arunachalam.
U.S. Appl. No. 12/628,068, filed Nov. 30, 2009, Arunachalam.
U.S. Appl. No. 12/628,069, filed Nov. 30, 2009, Arunachalam.

(Continued)

Primary Examiner — Viet Vu

(57) **ABSTRACT**

The present invention provides a method and apparatus for providing real-time, two-way transactional capabilities on the Web. Specifically, one embodiment of the present invention discloses a method for enabling object routing, the method comprising the steps of creating a virtual information store containing information entries and attributes associating each of the information entries and the attributes with an object identity, and assigning a unique network address to each of the object identities. A method is also disclosed for enabling service management of the value-added network service, to perform OAM&P functions on the services network.

13 Claims, 13 Drawing Sheets

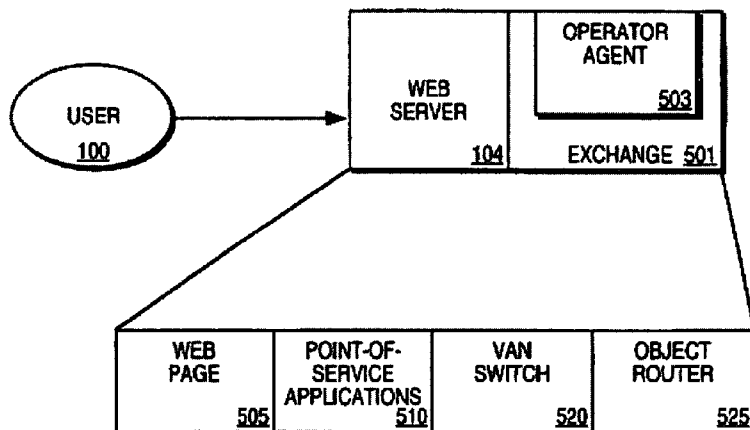

US 8,108,492 B2

Page 2

U.S. PATENT DOCUMENTS					
5,408,619 A	4/1995	Oran	5,892,821 A	4/1999	Turner
5,414,812 A	5/1995	Filip et al.	5,893,076 A	4/1999	Hafner et al.
5,428,792 A	6/1995	Conner et al.	5,895,454 A	4/1999	Harrington
5,432,937 A	7/1995	Tevanian et al.	5,897,621 A	4/1999	Boesch et al.
5,434,974 A	7/1995	Loucks et al.	5,901,228 A	5/1999	Crawford
5,440,744 A	8/1995	Jacobson et al.	5,909,492 A	6/1999	Payne et al.
5,442,771 A	8/1995	Filepp et al.	5,910,987 A	6/1999	Ginter
5,442,791 A	8/1995	Wrabetz et al.	5,913,061 A	6/1999	Gupta et al.
5,444,192 A	8/1995	Shetye et al.	5,931,967 A	8/1999	Shimitzu et al.
5,446,896 A	8/1995	Hegarty et al.	5,946,509 A	8/1999	Morton et al.
5,452,433 A	9/1995	Nihart et al.	5,956,400 A	9/1999	Chaum et al.
5,455,903 A	10/1995	Jolissaint et al.	5,956,509 A	9/1999	Kevner
5,475,819 A	12/1995	Miller et al.	5,958,004 A	9/1999	Helland et al.
5,491,800 A	2/1996	Goldsmith et al.	5,960,411 A	9/1999	Hartman et al.
5,517,645 A	5/1996	Stutz et al.	5,987,500 A	11/1999	Arunachalam
5,519,868 A	5/1996	Allen et al.	6,003,085 A	12/1999	Ratner et al.
5,537,464 A	7/1996	Lewis et al.	6,014,651 A	1/2000	Crawford
5,539,909 A	7/1996	Tanaka et al.	6,014,666 A	1/2000	Helland et al.
5,557,780 A	9/1996	Edwards et al.	6,049,785 A	4/2000	Gifford
5,560,005 A	9/1996	Hoover et al.	6,049,819 A	4/2000	Buckle et al.
5,577,251 A	11/1996	Hamilton et al.	6,055,514 A	4/2000	Wren
5,590,197 A	12/1996	Chen et al.	6,055,567 A	4/2000	Ganesan et al.
5,592,378 A	1/1997	Cameron et al.	6,073,237 A	6/2000	Ellison et al.
5,604,905 A	2/1997	Tevanian et al.	6,092,053 A	7/2000	Boesch et al.
5,613,148 A	3/1997	Bezviner et al.	6,094,673 A	7/2000	Dilip et al.
5,664,111 A	9/1997	Nahan et al.	6,101,482 A	8/2000	DeAngelo et al.
5,671,279 A	9/1997	Elgamal et al.	6,101,527 A	8/2000	Lejeune et al.
5,677,708 A	10/1997	Matthews, III et al.	6,119,152 A	9/2000	Carlin et al.
5,694,549 A	12/1997	Carlin et al.	6,125,185 A	9/2000	Boesch
5,703,344 A	12/1997	Bezy et al.	6,125,352 A	9/2000	Franklin et al.
5,706,442 A	1/1998	Anderson et al.	6,128,315 A	10/2000	Takeuchi
5,708,780 A	1/1998	Levergood et al.	6,134,594 A	10/2000	Helland et al.
5,710,887 A	* 1/1998	Chelliah et al. 705/26.62	6,135,646 A	10/2000	Kahn et al.
5,712,913 A	1/1998	Chaum	6,145,090 A	11/2000	Yamaguchi et al.
5,715,314 A	2/1998	Payne et al.	6,185,609 B1	2/2001	Rangarajan et al.
5,715,444 A	2/1998	Danish et al.	6,192,250 B1	2/2001	Buskens et al.
5,724,424 A	3/1998	Gifford	6,205,433 B1	3/2001	Boesch et al.
5,737,533 A	4/1998	de Hond	6,212,556 B1	4/2001	Arunachalam
5,742,762 A	4/1998	Scholl et al.	6,212,634 B1	4/2001	Gerr et al.
5,742,768 A	4/1998	Gennaro et al.	6,249,291 B1	6/2001	Popp et al.
5,745,681 A	4/1998	Levine et al.	6,279,001 B1	8/2001	DeBettencourt et al.
5,754,939 A	5/1998	Herz et al.	6,289,322 B1	9/2001	Kitchen et al.
5,757,917 A	5/1998	Rose et al.	6,295,522 B1	9/2001	Boesch
5,758,072 A	5/1998	Filepp et al.	6,301,601 B1	10/2001	Helland et al.
5,758,327 A	5/1998	Gardner et al.	6,327,577 B1	12/2001	Garrison et al.
5,771,354 A	6/1998	Crawford	6,327,579 B1	12/2001	Crawford
5,774,670 A	6/1998	Montulli	6,334,116 B1	12/2001	Ganesan et al.
5,778,178 A	7/1998	Arunachalam	6,360,262 B1	3/2002	Guenthner et al.
5,780,780 A	7/1998	Ahmed	6,363,362 B1	3/2002	Burfield et al.
5,781,631 A	7/1998	Chaum	6,411,943 B1	6/2002	Crawford
5,793,964 A	* 8/1998	Rogers et al. 709/202	6,453,426 B1	9/2002	Gamache et al.
5,794,221 A	8/1998	Egendorf	6,457,066 B1	9/2002	Mein et al.
5,794,234 A	8/1998	Church et al.	6,473,740 B2	10/2002	Cockrill et al.
5,809,483 A	9/1998	Broka et al.	6,473,791 B1	10/2002	Al-Ghosein et al.
5,812,779 A	9/1998	Ciscon et al.	6,486,895 B1	11/2002	Robertson et al.
5,822,569 A	10/1998	McPartlan et al.	6,490,567 B1	12/2002	Gregory
5,826,085 A	10/1998	Bennett et al.	6,530,518 B1	3/2003	Krichilsky
5,826,241 A	10/1998	Stein et al.	6,553,427 B1	4/2003	Chang et al.
5,828,666 A	10/1998	Focsaneanu et al.	6,574,607 B1	6/2003	Carter et al.
5,835,726 A	11/1998	Schwed	6,625,581 B1	9/2003	Perkowski
5,845,061 A	12/1998	Miyamoto et al.	6,678,664 B1	1/2004	Ganesan
5,845,073 A	12/1998	Carlin et al.	6,678,696 B1	1/2004	Helland et al.
5,845,265 A	12/1998	Woolston	6,714,962 B1	3/2004	Helland et al.
5,856,974 A	1/1999	Gervais et al.	6,839,677 B2	1/2005	Mathur et al.
5,859,978 A	1/1999	Sonderegger et al.	6,850,996 B2	2/2005	Wagner
5,864,866 A	1/1999	Henckel et al.	6,856,974 B1	2/2005	Ganesan et al.
5,870,473 A	2/1999	Boesch et al.	6,931,111 B1	8/2005	Coffee
5,870,724 A	2/1999	Lawlor et al.	6,932,268 B1	8/2005	McCoy et al.
5,873,072 A	2/1999	Kight et al.	6,948,063 B1	9/2005	Ganesan et al.
5,873,093 A	2/1999	Williamson et al.	7,076,784 B1	7/2006	Russell et al.
5,878,043 A	3/1999	Casey et al.	7,080,051 B1	7/2006	Crawford
5,878,140 A	3/1999	Chaum	7,107,244 B2	9/2006	Kight et al.
5,878,141 A	3/1999	Daly et al.	7,120,602 B2	10/2006	Kitchen et al.
5,878,403 A	3/1999	DeFrancesco et al.	7,146,338 B2	12/2006	Kight et al.
5,884,301 A	3/1999	Takano	7,175,074 B2	2/2007	Mejias et al.
5,889,957 A	3/1999	Ratner et al.	7,177,846 B2	2/2007	Moenickheim et al.
5,890,137 A	3/1999	Koreeda	7,213,003 B1	5/2007	Kight et al.
5,890,161 A	3/1999	Helland et al.	7,240,031 B1	7/2007	Kight et al.
			7,251,656 B2	7/2007	Keown et al.

US 8,108,492 B2

Page 3

7,296,004	B1	11/2007	Garrison et al.	
7,302,408	B2	11/2007	Engdahl et al.	
7,302,411	B2	11/2007	Ganesan et al.	
7,330,831	B2	2/2008	Biondi et al.	
7,334,128	B2	2/2008	Ganesan et al.	
7,340,506	B2	3/2008	Arunachalam	
7,366,696	B1	4/2008	Ganesan et al.	
7,366,697	B2	4/2008	Kitchen et al.	
7,383,226	B2	6/2008	Kight et al.	
7,389,514	B2	6/2008	Russell et al.	
7,392,223	B1	6/2008	Ganesan et al.	
7,395,243	B1	7/2008	Zielke et al.	
7,395,319	B2	7/2008	Harris et al.	
7,451,400	B2 *	11/2008	Bales et al.	715/734
7,590,550	B2 *	9/2009	Schoenberg	705/2
7,600,027	B2 *	10/2009	Yan	709/227
2001/0037318	A1	11/2001	Lindskog	
2002/0062218	A1	5/2002	Pianin	
2002/0152200	A1	10/2002	Krichilsky et al.	
2003/0069922	A1	4/2003	Arunachalam	
2008/0091801	A1	4/2008	Arunachalam	
2009/0094347	A1 *	4/2009	Ting et al.	709/219

OTHER PUBLICATIONS

Order, Motion to Bifurcate and for early trial on the Issue of Inequitable Conduct, on Mar. 19, 2009, Dismissal with Prejudice, order dated Dec. 30, 2009, Denied as Moot, Order Granted, signed by JFF, C.A. No. 08-131 (JFF), Allstate Docket #155.

Order, Motion to Bifurcate and for early trial on the Issue of Inequitable Conduct, on Mar. 19, 2009, Dismissal with Prejudice, order dated Dec. 30, 2009, Denied as Moot, C.A. No. 08-132 (JFF) and C.A. No. 08-133 (JFF), Dell Docket #155, signed by JFF, Order, Motion to Bifurcate and for early trial on the Issue of Inequitable Conduct, on Mar. 19, 2009, Dismissal with Prejudice, order dated Dec. 30, 2009, Denied as Moot, C.A. No. 08-132 (JFF) and C.A. No. 08-133 (JFF), Dell Docket #155.

Plaintiff WebXchange Inc.'s Surreply in Opposition to Defendants' Motion to Bifurcate, and for Early Trial on, the Issue of Inequitable Conduct (C.A. No. 08-132 (JFF) and C.A. No. 08-133 (JFF) , is Granted Plaintiff's Surreply in Opposition to Defendant's Motion to Bifurcate and for Early Trial on, The Issue on Inequitable Conduct is deemed filed (Entered Dec. 30, 2009), Dell Docket #157.

Dell Inc.'s Second Amended Answer and Counterclaims to WebxChange Inc.'s Original Complaint for Patent Infringement (Entered: Jan. 20, 2010), Dell Docket #164.

Plaintiff WebxChange Inc.'s Surreply in Opposition to Defendants' Motion to Bifurcate, and for Early Trial on, The Issue of Inequitable Conduct (Entered Dec. 30, 2009), Fedex Docket #212.

Memorandum Opinion C.A. 08-133-JFF, and C.A. 08-132-JFF (Entered Dec. 30, 2009), Fedex Docket #215.

Defendant's Fedex Corporation, Fedex Kinko's Office & Print Services, Inc., and Fedex Corporate Services, Inc.'s Second Amended Answer, Affirmative Defenses, and Counterclaims to Plaintiff WebXchange, Inc.'s Complaint (Entered Jan. 20, 2010), Fedex Docket #217.

U.S. Appl. No. 60/208,057, filed May 31, 2000, Krichilsky.

U.S. Appl. No. 08/168,519, filed Dec. 1993, Gifford.

UIUC, "The Common Gateway Interface", pp. 1-4, <http://hoohoo.ncsa.uiuc.edu/cgi/primer.html>, Retrieved on May 22, 2001, WBX 000.

Arnold, K. et al., "Media-Independent Interfaces in a Media-Dependent World", USENIX Conference on Object-Oriented Technologies, Monterey, CA Jun. 1995, WBX001.

Arshad, K.M. et al., "A CORBA based framework for trusted E-Commerce Transactions", Enterprise Distributed Object Computing Conference, pp. 18-25, EDOC '99 Sep. 27, 1999, WBX002.

Atkinson, R. , RFC 1825: "Security Architecture for the Internet Protocol", Naval Research Laboratory, Category: Standards Track, Network Working Group, Aug. 1, 1995 , WBX007.

Banks, M. , "America Online: A Graphics-based Success", Link-Up, Jan./Feb. 1992 , WBX008.

Banks, M. , "Compuserve for Windows", M.I.S Press, 1994, WBX009.

Baquero, C. et al., "Integration of Concurrency Control in a Language with Subtyping and Subclassing", USENIX Conference on Object-Oriented Technologies, Jun. 1995, WBX010.

Barron, C. and Weil, B., "Dr. Dobbs Portal: Implementing a Web Shopping Cart", Online Transactions in PERL, Sep. 1, 1996 WBX011.

Bharat, K. et al. , "Visual Obliq: A System for Building Distributed, Multi-User Applications by Direct Manipulation", SRC 130a, DEC, Oct. 31, 1995, WBX012.

Bharat, K. et al., "Distributed Applications in a Hypermedia Setting", Proc. Intl Workshop on Hypermedia Design, <http://www.cc.gatech.edu/gvu/people/PhDKrishnaIWHD.html>, Jun. 1, 1995 WBX013.

"CyberCash Cash Register Internet Payment Service". retrieved May 23, 2001 <http://www.cybercash.com/cashregister> pp. 1-2. 1996, WBX034.

"CyberCash—Cash Register—How it Works" retrieved May 23, 2001 <http://www.cybercash.com/cashregister/howitworks.html> pp. 1-3. 1996, WBX035.

"CyberCash—Industry Leading Features" retrieved May 23, 2001 <http://www.cybercash.com/cashregister/features.html> pp. 1-4. 1996, WBX036.

"CyberCash Cash Register—Online Secure Payment Service" CashRegister Demos. retrieved May 23, 2001 <http://www.webdata.cybercash.com/demos/> pp. 1-2. 1996, WBX038.

"CyberCash FraudPatrol.TM. Service" retrieved oMay 23, 2001 <http://www.cybercash.com/fraudpatrol/> pp. 1-2. 1996, WBX039.

"CyberCash FraudPatrol—How It Works" retrieved on May 23, 2001 <http://www.cybercash.com/fraudpatrol/howitworks.html> pp. 1-2 '96, WBX040.

"CyberCash Home", <http://www.cybercash.com> [retrieved on May 23, 2001] 1996, WBX041.

"CyberCash ICVerify for Windows" Version 2.5 Upgrade, <http://www.cybercash.com/icverify/upgrade.html> pp. 1-2 [retrieved on May 23, 2001] 1996 , WBX043.

Cybercash, "ICVERIFY—Features" retrieved on May 23, 2001 <http://www.cybercash.com/icverify/features.html>, 1996, pp. 1-3, WBX044.

Brando, T., "Comparing DCE and CORBA", Mitre Document MP 95B-93, Mar. 1, 1995, WBX018.

Business Wire , "Open Market releases first complete software solution" 1995, WBX025.

Business Wire, "Sunsoft delivers early access release of Distributed Objects Environment", Jun. 14, 1995, WBX026.

Case, J. et al. , "Network Management and the Design of SNMP", Connexions (ISSN 0894-5926), vol. 3, No. 3, Mar. 1989, WBX027.

Chung, S. et al. , "A Heterogeneous Distributed Information System", IEEE, pp. 443-447, 1993, WBX029.

Courtney, A., "Phantom: An Interpreted Language for Distributed Programming", Proceedings of USENIX Conference on Object-Oriented Technologies, Monterey, CA, Jun. 1995, WBX030.

Cybercash, "Affiliate Marketing Service", <http://www.cybercash.com/products/affiliatemarketing.html> [retrieved on May 23, 2001] 1996, WBX031.

"CyberCash B2B Payment Services", <http://www.cybercash.com/b2b> pp. 1-2 [retrieved May 23, 2001] 1996, WBX032.

CyberCash B2B Services, 1996, WBX033.

CyberCash Cash Register Internet Payment Service—Online Secure Payment Service. retrieved on May 23, 2001 from <http://www.cybercah.com/cashregister> pp. 1-2, '96, WBX034.

"CyberCash—Cash Register—How it Works" retrieved May 23, 2001 from <http://www.cybercash.com/cashregister/howitworks.html> pp. 1-3. '96, WBX035.

"CyberCash—Industry Leading Features", retrieved May 23, 2001 <http://www.cybercash.com/cashregister/features.html> pp. 1-4, 1996, WBX 036.

"CyberCash Cash Register—Online Secure Payment Service" CashRegister Demos. retrieved May 23, 2001 <http://www.webdata.cybercash.com/demos/> pp. 1-2 1996, WBX038.

"CyberCash FraudPatrol.TM. Service" retrieved on May 23, 2001 <http://www.cybercash.com/fraudpatrol/> pp. 1-2. 1996, WBX039.

"CyberCash FraudPatrol—How It Works" retrieved on May 23, 2001, <http://www.cybercash.com/fraudpatrol/howitworks.html> pp. 1-2 1996, WBX 040.

US 8,108,492 B2

Page 4

- Cybercash, "ICVerify—Features" retrieved on May 23, 2001 from <http://www.cybercash.com/icverify/features.html>, 1996, pp. 1-3, WBX044.
- Cybercash, "Payment Software for Brick and Mortar Merchants" <http://www.cybercash.com/pcauthorize> 1996-2001, WBX046.
- Dr. Gui on Components, COM and ATL, http://msdn.microsoft.com/library/welcome/dsmstdn/msdn_druguion020298.htm, Feb. 2, 1998, pp. 1-61 [retrieved on May 22, 2001], WBX057.
- Cybercash, "Products" 1996. retrieved on May 23, 2001 from <URL: <http://www.CyberCash.com/products/>, 1996, pp. 1-2, WBX048.
- Cybercash, "WebAuthorize—Enterprise and Hosting Payment Processing". retrieved on May 23, 2001 from <URL:<http://www.cybercash.com/webauthorize/>, 1996, pp. 1-2, WBX050.
- Davis et al., "A Protocol and Server for a Distributed Digital Technical Report Library", Apr. 25, 1994, WBX051.
- Davison, A. , "Coding with HTML forms HTML goes interactive", (hypertext markup language)(Tutorial), Dr. Dobb's Journal, Jun. 6, 1995, vol. 20, No. 6, 19 pages, WBX052a.
- Davison, A. , "Coding with HTML forms: HTML goes interactive", Dr. Dobb's Journal, Jun. 6, 1995, vol. 20, No. 6, pp. 70-79, WBX052b.
- "Distributed Object Technology in the Financial Services Industry: Trading and Risk Management", A White Paper, Sun Microsystems, 1995, WBX053.
- Deng, R.H. et al. , "Integrating Security in CORBA-based Architectures", IEEE, Jun. 1995, pp. 50-61, WBX054.
- Detlefs, D. et al., Debugging Storage Management Problems in Garbage Collected Environments, Proc of USENIX Conference on Object-Oriented Technologies, Monterey, CA, Jun. 1995, WBX055.
- Dietering, T. , Object-Oriented Implementation of a Multiprotocol Hyper-G client for MS-Windows, Diplomarbeit in Telematik, TU Graz, Jul. 1, 1995, WBX056.
- Birrell A. et al. , "Network Objects", SRC Research Report, Feb. 28, 1994, WBX014.
- Edwards, N. , Object Wrapping (for WWW)—The Key to Integrated Services, ANSA Phase III, Apr. 25, 1995 , WBX058.
- Ehikioya, S.A., "An Agent-Based System for Distributed Transactions: a Model for Internet-Based transactions", Elec and Computer Engg IEEE Canadian Conf, V1, May 9, 1999, p. 289-294, WBX059.
- Microsoft DJ Order, C-08-05149 WHA "Order Granting Defendant's Motion to Dismiss", Federal Court of Northern California, Feb. 17, 2009, WBX060.
- "Portal Solutions, an Open Market eBusiness Solution Brief". White Paper. Open Market, Forrester Research TechRankings, Feb. 2001, WBX061.
- "Wireless Solutions, An Open Market eBusiness Solution Brief", WhitePaper. Open Market, Forrester Research Tech Rankings, Feb. 2001, WBX062.
- Fraga, J. et al. , "A Programming Model for Real-Time Applications in Open Distributed Systems", IEEE, 1995, pp. 104-111, WBX063.
- Birrell A. et al. , "Implementing Remote Procedure Calls", Xerox Palo Alto Research Center, ACM Transactions, Feb. 1, 1994 , WBX015.
- Bowen, C. et al. , "How to Get the Most out of CompuServe" 5th Ed. 1991, Random House, Inc. 1991, WBX016.
- Braden, R. et al. , RFC 1122: "Requirements for Internet Hosts—Communication Layers" Oct. 1, 1989, WBX017.
- Broadvision, "Broadvision One-to-One: On-line Marketing and Selling Application System Developers' Guide", 1995, WBX020.
- Broadvision, "Broadvision One-to-One: On-Line Marketing and Selling Application System: Dynamic Command Center User's Guide", 1995, WBX021.
- Broadvision, "Broadvision One-to-One: On-Line Marketing and Selling Application System: Installation and System Administration Guide" 1995, WBX022.
- Broadvision, "Broadvision One-to-One: On-Line Marketing and Selling Application System: Technical Overview", 1995, WBX023.
- Glossbrenner, A. , "MasterGuide to CompuServe", "Chapter 15: Travel Services: Join CompuServe and See the World", Prentice Hall, 1987, WBX065.
- Gross, C., "Taking the Splash Diving into ISAPI", ISAPI Programming, Microsoft Interactive Developer, www.microsoft.com/mind/0197/ISAPI.htm, Jan. 1, 1997, pp. 1-10, retrieved May 22, 2001 WBX066.
- "Open Market Inc, Managing in a Turbulent Environment", Harvard Business School, 9-196-097, Aug. 29, 1996 , WBX067.
- Hickey, M., "Shopping at Home: One Modem Line, No Waiting", Home PC, Dec. 1, 1994, p. 307, Dialog, File 647, Acc# 01038162, WBX068A.
- Lang, , "Cashing In: The Rush is on to Buy and Sell on the Internet But on Sidelines for Now", Advertising Age, Dec. 19, 1994, p. 11, Dialog, File 16, Acc# 05419137, WBX068B.
- Lichty, T. , "America Online Tour Guide", MacIntosh Edition, Version 2, Chapter 1, 3, 8, 10, 1992, WBX068C.
- Tymnet, Wikipedia, the free encyclopedia. <http://en.wikipedia.org/wiki/tymnet>, Retrieved on May 1, 2007, WBX068D.
- Cox, B. et al. , "NetBill Security and Transaction Protocol", Carnegie Mellon University, Pittsburgh, PA 15212-3890, undated, WBX068E.
- Lamond, K. et al. , "Credit Card Transactions Real World and OnLine", http://www.virtualschool.edu/mon/ElectronProperty/klamond/credit_card.htm, 1996, pp. 1-16, WBX068F.
- "Open Market Catalog Centre", Enterprise Content, www.openmarket.com/cgi-bin/gx.cgi/AppLogic+FT-ContentServer?pagename=FutureTense/Apps/Xcelerate/Render&c=Arti_ZZZ, WBX069.
- Business Wire, High Beam Wire, "Open Market releases first complete software solution" Oct. 16, 1995, WBX070.
- McCloghrie, K. et al. , RFC 1156, "Management Information Base for Network Management of TCP/IP-based internets", May 1, 1990 , WBX071.
- Case, J. et al. , RFC 1157 May 1, 1990, WBX072.
- Rose, M. RFC 1283: "SNMP over OSI", Dec. 1, 1991, WBX073.
- Rose, M. et al. , RFC 1155: "Structure and Identification of Management Information for TCP/IP-based internets", May 1, 1990, WBX074.
- Case, J. et al. , RFC 1442: "Structure of Management Information for version 2 of the Simple Network Management Protocol (SNMPv2)", AllState 00011394 Apr. 1, 1993, WBX075.
- "ORBIX Programmer's Guide", IONA Technologies, Oct. 1, 1997, WBX076A-E.
- "ORBIX Programmer's Guide", Release 1.3.1, IONA Technologies, Feb. 1, 1995, WBX077.
- Ito, J. et al. , "Using meta-objects to support optimization in the Apertos Operating System", USENIX Conference on Object-Oriented Technologies, Monterey, CA, Jun. 1995, WBX078.
- Jordan, M. et al. , "Software Configuration Management in an Object-Oriented Database", USENIX Conference on Object-Oriented Technologies, Monterey, CA, Jun. 1995, WBX079.
- Kane, P. , "Prodigy Made Easy", "Chapter 6, Shopping Made Easy", 2nd ed., 1993, WBX080.
- Lagoze, C. et al. , "Dienst: Implementation Reference Manual", May 5, 1995, WBX081.
- Open Market Commerce Products, Enterprise Content www.openmarket.com/cgi-bin/gx.cgi/AppLogic+FTContentServer?pagename=FutureTense/Apps/Xcelerate/Render&c=A_ZZZ, WBX082.
- Lange, D.B. et al. , "Program Explorer: A Program Visualizer for C++", Proceedings of the USENIX Conference on Object-Oriented Technologies, Monterey, CA, Jun. 1995, WBX083.
- Laufer, K. , "A Framework for Higher Order Functions in C++", Proceedings of the USENIX Conference on Object-Oriented Technologies, Monterey, CA, Jun. 1995, WBX084.
- Li, G. and Bacon, J., "Supporting Distributed Real-Time Objects", IEEE Jul. 1994, pp. 138-143, WBX085.
- Limprecht, R. , "Microsoft Transaction Server", IEEE, Compcon '97 Proceedings, 1997, pp. 14-18, WBX086.
- Maffei, S. , "Adding Group Communication and Fault-Tolerance to CORBA", Proceedings of the USENIX Conference on Object-Oriented Technologies, Monterey, CA, Jun. 1995 , WBX087.
- Mahindra, A. et al. , "Dynamic Insertion of Object Services", Proceedings of the USENIX Conference on Object-Oriented Technologies, Monterey, CA, Jun. 1995, WBX088.

US 8,108,492 B2

Page 5

- McCloghrie, K. et al., RFC 1213, "Management Information Base for Network Management of TCP/IP-based internets: MIB-II", SNMP Working Group, Mar. 1, 1991, WBX089.
- McCloghrie, K. et al., RFC 1447, "Party MIB for version 2 of the SIMPLE Network Management Protocol", SNMP Security Working Group, Apr. 1, 1993, WBX090.
- McKie, S., "EEP Meets Web E-Commerce", DBMS, Jul. 1, 1998, WBX091.
- McMaster D. et al., RFC 1516: "802.3 Repeater devices—Definition of Managed Objects", Feb. 9, 1992, WBX092.
- "Allstate Connects with Countrywide Producer Network in Seven Months Using Microsoft Visual Studio.NET and the .NET Framework", Microsoft.Net Customer Solution, Jan. 2003, WBX 093.
- O'Brien Jones, U.S. Appl. No. 90/010,346 which is the 5,778,178 Re-exam doc, Exhibits Part 1-WBX101, Exhibits Part 2-WBX102, Nov. 21, 2008 Third Party Requests, WBX094.
- "Microsoft Component Services, Server Operating System, A Technology Overview", <http://www.microsoft.com/com/wpaper/compsvcs.asp>, Aug. 15, 1998, [retrieved on May 22, 2001], WBX095.
- Allstate Uses Web Services to Quickly Create Insurance Policy Management Solution, Microsoft .NET Customer Solution Case Study, Jan. 2005, WBX098.
- Mitchell et al., "An Overview of the Spring System", Sun Microsystems, WBX099.
- Muckelbauer, P. and Russo, V., "Lingua Franca: An IDL for Structured Subtyping Distributed Object Systems", USENIX Conference: Object-Oriented Technologies, Monterey, CA, WBX100.
- Reynolds, J. Posting to comp doc USENET group, <http://nyurl.com/53a95p>, RFC 1212, 1213- Google groups on concise definitions MIB and MIBII, Exhibit G, Mar. 27, 1991, WBX045.
- Relihan, L. et al., "Untangling the World-Wide Web.", 12th Annual International Conference on Systems Documentation, Oct. 1, 1994, pp. 17-24, ACM, WBX102A.
- Rose, M. T., "The Simple Book: An Introduction to Internet Management", 1994, pp. 14-15, 379-387 (2nd ed.) Exhibit F, WBX102C.
- "Open Market Enterprise: Content Server", www.openmarket.com/cgi-bin/gx.cgi/AppLogic+FTContentServer?pagename=FutureTense/Apps/Xcelerate/Render&c=Artic, pp. 1-4, WBX103.
- "Open Market Enterprise: Content Center", www.openmarket.com/cgi-bin/gx.cgi/AppLogic+FTContentServer?pagename=FutureTense/Apps/Xcelerate/Render&c=Artic, Retrvd5/15/01, WBX104.
- "Open Market Enterprise: Content-Driven eBusiness", www.openmarket.com/cgi-bin/gx.cgi/AppLogic+FTContentServer?pagename=FutureTense/Apps/Xcelerate/Render&c=Artic, WBX105.
- "Open Market ShopSite 5.0", Retrieved on May 15, 2001 from: <URL <http://www.openmarket.com/cgi-bin/gx.cgi/AppLogic+FTContentServer?pagename=FutureTense/Apps>, WBX 112.
- Orfali, R. et al., "Essential Client/Server Survival Guide"-John Wiley and Sons—Set 1, 1994, WBX114.
- Orfali, R. et al., "Essential Client/Server Survival Guide"-John Wiley and Sons—Set 2, 1994, WBX115.
- Orfali, R.; Harley, D.; Edwards, J., "Essential Client/Server Survival Guide" John Wiley and Sons, Sets 1-4, Jun. 16, 2005, WBX116.
- Orfali, R. et al., "Essential Client/Server Survival Guide"-John Wiley and Sons—Set 4, 1994, WBX117.
- Pavlou, G. et al., "A Generic Management Information Base Browser", WBX119.
- Peterson, L. et al., "Computer Networks, A Systems Approach", Morgan Kaufmann Publishers, Inc., 1996, pp. 472-507, WBX120.
- Pitkow, J. et al., "Using the Web as a Survey Tool: Results from the Second WWW User Survey", conducted 10/15 & Nov. 1994, presented at 3rd Intl WWW Conference Apr. 10-14, 1995; WBX121.
- Netscape Unveils New Versions of Commercial Applications for Enhanced Integration with Corporate Databases, NetScape Press Release, May 13, 1996, WBX122.
- Raatikainen, K., "Database Access in Intelligent Networks", Proceedings of IFIP TC6 Workshop on Intelligent Networks, pp. 163-183, WBX123.
- Radia, S. R. et al., "The Spring Object Model", Proceedings of the USENIX Conference on Object-Oriented Technologies, Monterey, CA, Jun. 1995, WBX124.
- Rosenberry, et al., "OSF Distributed Computing Environment—Understanding DCE"—O'Reilly & Associates, Jun. 1993, WBX126.
- Rubin, C. "Wired: In the Bag", Jun. 1997, WBX127.
- Schepp et al., "The Complete Guide to CompuServe: Chapter 12: Travel Services: See the World Today the CompuServe Way", 1990, pp. 409-437, McGraw Hill, WBX128.
- Schmidt, D. et al., "Object-Oriented Components for High-Speed Network Programming", Prcdgs of USENIX Conference on Object-Oriented Technologies, Monterey, CA, Jun. 1995, WBX 129.
- Siegel, J., "Common Object Services Specification vol. 1, Rev 1, First Edition", OMG Doc Jan. 1, 1994, Mar. 1, 1994, WBX130, WBX130A.
- "Common Desktop Environment: Product Glossary", SunSoft, 1994-1995, WBX131.
- "Common Desktop Environment: Applications Builder User's Guide", SunSoft, 1994-1995, WBX132.
- "OpenStep Development Tools", SunSoft, 1996, WBX133A, WBX133B.
- Porting NextStep 3.2/3.3 Applications to OpenStep on Solaris, Sunsoft, 1996, WBX134.
- "Solstice X.500 Programming Reference", SunSoft, 1996, WBX135, A, B.
- Tatters, W., "Navigating the Internet with Compuserve: Chapter 17: Business on the Net", 1995, pp. 352-374, Sams Publishing, WBX136.
- Technical Staff, "The Conductor Financial Services Framework": Distributed Objects on the Internet, Block Financial Corporation White Paper, BFC Technology Center, Oct. 17, 1995 WBX137.
- Vogler, H. et al., "The Transaction Internet Protocol in Practice: Reliability for WWW Applications", IEEE 1999 Internet Workshop IWS99, (ISSN-0-7803-5925-9), Feb. 18, 1992, WBX146.
- Weich, C., "Generic Containers for a Distributed Object Store", Prcgs of the USENIX Conference (Jun. 1995) on Object-Oriented Technologies, Monterey, CA, May 18, 1995, WBX150.
- "SmallTalk" Wikipedia SmallTalk <http://www.objs.com/x3h7/smalltalk.htm> and <http://en.wikipedia.org/wiki/Smalltalk> WBX151.
- Wollrath, A. et al., "Simple Activation for Distributed Objects", Proceedings of the USENIX Conference on Object-Oriented Technologies, Monterey, CA, Jun. 1995, WBX152.
- USENIX, "Agenda of Proceedings of the USENIX Conference on Object-Oriented Technologies", Monterey, CA, Jun. 1995, WBX153.
- "Common Desktop Environment: Desktop Kornshell User's Guide", Sun Microsystems, 1994-1995, WBX154.
- "Common Desktop Environment: Help System Author's and Programmer's Guide", Sun Microsystems, 1994-1995, (Three parts) WBX155.
- "Common Desktop Environment: Internationalization Programmer's Guide", Sun Microsystems, 1994-1995, WBX156.
- "Common Desktop Environment: Tooltalk Messaging Overview", Sun Microsystems, 1994-1995, WBX157.
- "Common Desktop Environment: Common StyleGuide and Certification CheckList", SunSoft, 1994-1995, WBX158, 158C.
- "Common Desktop Environment: Programmer's Overview", SunSoft, 1994-1995, WBX159.
- Developer's Guide to Internationalization, Sun Microsystems, 1994, WBX160.
- "Dr. Gui's Gentle Guide to COM", <http://www.microsoft.com/Com/news/drgui.asp> [retrieved on May 22, 2001], Nov. 1, 1999, WBX161.
- "iPIN Company Info", <http://www.ipin.com/01comp.html> [retrieved on May 23, 2001], iPIN Interactive Transaction Services, Inc., 2000, WBX162.
- "iPIN Home", <http://www.ipin.com> [retrieved on May 23, 2001], iPIN Interactive Transaction Services, Inc., 2000, WBX163.
- "iPIN Service Options", http://www.ipin.com/02prod_service.html [retrieved on May 23, 2001], iPIN Interactive Transaction Services, Inc., 2000, WBX164.

US 8,108,492 B2

Page 6

- "iPIN Solutions", http://www.ipin.com/02prod_solution.html [retrieved on May 23, 2001], iPIN Interactive Transaction Services, Inc., 2000, WBX165.
- "iPIN Partners", <http://www.ipin.com/03part.html> [retrieved on May 23, 2001], iPIN Interactive Transaction Services, Inc., 2000, WBX166.
- "iPIN Technology", http://www.ipin.com/02prod_tech.html [retrieved on May 23, 2001], iPIN Interactive Transaction Services, Inc., 2000, WBX167.
- NetScape Products: Open and Secure Internet Software, 1995, WBX168A.
- NetScape Merchant System, Data Sheet 1995, WBX168B.
- NetScape Internet Applications, Customer Showcase 1995, WBX168C.
- NetScape Server API, 1995, WBX 168D.
- NetScape Object-Oriented Pradigm of Server Configuration, 1995, WBX168E.
- RSA: Verisign Redirection Information, Important Announcement 1995, WBX168F.
- RSA: Verisign to Provide Digital IDs for Open Market's Secure WebServer, 1995, WBX168G.
- Verisign Adds the Missing Component to Online Security Solutions 1995, WBX168H.
- Hickman, K.E.B.; Netscape, "The SSL Protocol", 1995, WBX168I.
- NetScape iStore DataSheet, 1995, WBX168J.
- Choudhury, A.K. et al. , "Copyright Protection for Electronic Publishing over Computer Networks", 1995 IEEE Network, 9, May/Jun., vol. 3 pp. 12-20 (1995) WBX168L.
- NSAPI Basics, (Chapter 1) <http://developer.netscape.com/docs/manuals/enterprise/nsapi/svrop.htm> [retrieved on May 22, 2001], 1997, WBX174.
- "OpenStep User Interface Guidelines", SunSoft, 1996, WBX175.
- "OpenStep Programming Reference", SunSoft, 1996 , (12 parts) WBX176.
- "QuickStart to Using the Open Step Desktop", SunSoft, 1996, WBX177.
- Rose, M. et al. , "RFC 1065:Structure and Identification of Management Information for TCP/IP-based internets",Aug. 1, 1988, WBX178.
- Stewart, B. , RFC 1318: "Definition of Managed Objects for Parallel-printer-like Hardware Devices", Apr. 1, 1992, WBX179.
- Rivest, R., "RFC 1321: The MD5 Message-Digest Algorithm", 1997, WBX180.
- Solaris Common Desktop Environment: MOTIF Transition Guide, Sun Microsystems, 1997, WBX181.
- "Solaris Common Desktop Environment: Programmer's Guide", Sun Microsystems, 1994-1995, WBX182.
- "The iPin Approach", <http://www.ipin.com/02prod.html>, 2000, [retrieved on May 23, 2001], Interactive Transaction Services, Inc., WBX183.
- Orfali, R. et al. , "The Essential Distributed Objects Survival Guide"-Part1-1, John Wiley and Sons, 1996, WBX201.
- Orfali, R. et al. , "The Essential Distributed Objects Survival Guide"-Part1-2, John Wiley and Sons, 1996 , WBX202.
- Orfali, R. et al. , "The Essential Distributed Objects Survival Guide"-Part1-3, John Wiley and Sons, 1996, WBX203.
- Orfali, R. et al. , "The Essential Distributed Objects Survival Guide"-Part2-1, John Wiley and Sons, 1996, WBX204.
- Orfali, R. et al. , "The Essential Distributed Objects Survival Guide"-Part2-2, John Wiley and Sons, 1996 , WBX205.
- Orfali, R. et al. , "The Essential Distributed Objects Survival Guide"-Part2-3, John Wiley and Sons, 1996, WBX206.
- Orfali, R. et al. , "The Essential Distributed Objects Survival Guide"-Part3-1, John Wiley and Sons, 1996 , WBX207.
- Orfali, R. et al. , "The Essential Distributed Objects Survival Guide"-Part3-2, John Wiley and Sons, 1996 , WBX208.
- Orfali, R. et al. , "The Essential Distributed Objects Survival Guide"-Part3-3, John Wiley and Sons, 1996, WBX209.
- Orfali, R. et al. , "The Essential Distributed Objects Survival Guide"-Part4-1, John Wiley and Sons, 1996, WBX210.
- Orfali, R. et al. , "The Essential Distributed Objects Survival Guide"-Part4-2, John Wiley and Sons, 1996, WBX211.
- Orfali, R. et al. , "The Essential Distributed Objects Survival Guide"-Part4-3, John Wiley and Sons, 1996, WBX212.
- Orfali, R. et al. , "The Essential Distributed Objects Survival Guide"-Part4-4, John Wiley and Sons, 1996 , WBX213.
- Broadvision , "Broadvision One-to-One: Programmer's Reference, Part 1" 1995 , WBX214.
- Broadvision , "Broadvision One-to-One: Programmer's Reference, Part 2" 1995 , WBX215.
- OMG , "The Common Object Request Broker: Architecture and Specification", CORBA v2.0_(NYC-#1655390-v1), Jul. 1995-1996, WBX216.
- The Open Group , "Inter-domain Management: Specification Translation", 1997, WBX222.
- The Open Group , "Inter-domain Management_Summary of Similarities and Differences", 1997, WBX223.
- The Open Group , "Inter-domain Management_object models comparison", 1997, WBX224.
- Miller, M. , "Managing Internetworks with SNMP", 1993, pp. 138-139, M&T Books., '506 Inter Partes Re-examination Exhibit 12, Dec. 2008, WBX225.
- Umar, A. , "Distributed Computing: A Practical Synthesis", "Appendix B: Tutorial on TCP/IP Protocol Suite", (BellCore), 1993, WBX226.
- Umar, A. , "Distributed Computing: A Practical Synthesis", "Chapter 5: Client-Server Systems and Application- Interconnectivity", (BellCore), 1993, WBX227.
- SPERO,"Binary Gateway Interface-An API for Dynamically Extensible http Servers",Jul. 1, 1994, Retrieved on Apr. 5, 2009 from <http://www.ibiblio.org/mdma-release/BGI-spec.txt>, WBX228.
- "Point, Click and Shop Never So Easy;The CheckFree Wallet",NewsHound,SJMercury News, PRNewswire,Apr. 10, 1995, Retrieved Apr. 5, 2009 from http://besser.tsoa.nyu.edu_ZZZ,WBX229.
- DEC ObjBroker.1.0.9,Apr. 3, 1996,http://209.85.173.132/search?q=cache:c3iJxZca3aUJ:www.faqs.org/faqs/object-faq/part3/+DEC%27s+ObjectBroker+Service&cd=9&hl=en&ct=clnk&g_ZZZ,WBX230.
- Arunachalam , U.S. Appl. No. 11/980,185_Duty of Candor Rule 56 Disclosure, Feb. 11, 2009, WBX220.
- Arunachalam , U.S. Appl. No. 11/980,185_Duty of Candor Rule 56 Disclosure, Mar. 4, 2009, WBX221.
- NYC-#1579692-v1-WebXchange__ _March_3_DELL_Complaint.DOC, Mar. 3, 2008, WBX217.
- NYC-#1579751-v1-WebXchange__ _March_3_Allstate_Complaint.DOC, Mar. 3, 2008, WBX218.
- NYC-#1579947-v1-WebXchange__ _March_3_FedEx_Complaint.DOC, Mar. 3, 2008, WBX219.
- "Easel Corporation Introduces Comprehensive Program",Mar. 13, 1995, Business Wire, http://209.85.173.132/search?q=cache:McsjZC2srEJ:findarticles/mi_m0EIN/is_1995_Marc_ZZZ, WBX231.
- "Internet Information Commerce:The First Virtual",Jul. 1995,1st USENIX Wkshp:E-Commerce,NY Retrvd Apr. 9, 2009http://www.usenix.org/publications/library/proceedings/ec95/f_ZZZ,WBX232.
- "O'Reilly Releases Website",WebView,EIT,May 12, 1995,V7:Issue41,ISSN1004-042X, Computer underground Digest, RtrvdApr. 5, 2009http://cu-digest.org/CUDS7/cud74_ZZZ,WBX233.
- "RSA And EIT Joint Venture", Terisa Systems, EIT and RSA: Secure HTTP, Jun. 13, 1994, Retrieved on Apr. 5, 2009 <http://1997.webhistory.org/www.lists/www-talk.1994q2/0980.html>,WBX234.
- "CommerceNet The First Large-Scale Market Trial",EIT:CommerceNet, Aug. 3, 1994, Proc.May 1994, Ties That Bind conference, Rtrvd Apr. 5, 2009 http://internet.eser_ZZZ, WBX235.
- Rubin, A., "IETF-Stockholm meeting" NetCheck:E-signatures,Aug. 5, 1995,pp. 1-2,CIPHER,NewsletterIEEE Computer Society's TC 8, http://www.ieee-security.org/Cipher/PastIssu_ZZZ,WBX236.
- Open Market, "FastCGI:A High-Performance Web Server Interface", Apr. 1996, Retrieved on Apr. 5, 2009 <http://www.fastcgi.com/devkit/doc/fastcgi-whitepaper/fastcgi.htm>,WBX 237.

US 8,108,492 B2

Page 7

Sun Microsystems, "HotJava", Wikipedia, the free encyclopedia, Jun. 1995, Retrieved on Apr. 5, 2009 from <http://en.wikipedia.org/wiki/HotJava>, WBX238.
W3C Status Codes, HTRESP_html_w3_org, 1992 WBX239.
Hewlett Packard, "HP Oadapter/OpenODB", Jul. 1994, Retrieved on Apr. 5, 2009 from <http://web.bilkent.edu.tr/Online/oofaq/oo-faq-S-8.13.0.5.html>, WBX240.
Internet Shopping Network_ISN Business Newswire (1995) WBX241.
NCR Co-operative Frameworks 3, (1993) WBX242.
Distributed Objects Everywhere, NEO, Wikipedia (1996) WBX243.
NetMarket (1996) WBX244.
Enterprise Object Netorks, Wikipedia (1996) WBX245.
OMG Document No. 91_12_1 Revision 1_1 (1997) WBX246.
DigiCash Smartcards (1997) WBX247.
IBM System Object Model_SOM (1998) WBX248.
IBM System Object Model_SOM_DSOM (1998) WBX249.

Open Market StoreBuilder (1995) WBX250.
WebXpress Web StoreFront (1996) WBX251.
PNC, Industry.Net do eCommerce (1996) WBX252.
10KPowerShip,PowerPartner (1996) WBX253.
T. Berners Lee Hypertext Mark up Language RFC1866(1995) WBX 254.
E. Nebel RFC1867 (1995) WEBX255.
RFC1942 (1996) WEBX256.
J. Seidman RFC1980 (1996) WBX257.
HTML—Wikipedia, the free encyclopedia—Notepad (1998) WBX258.
Berners-Lee, T., RFC 1630, "Universal Resource Identifiers in WWW", Network Working Group, CERN, Jun. 1994 WBX259.
Object Broker Service Middleware Sourcebook (1995) WBX260.
WBXexecsummary4809new2bizplan[1] (2009) WBX268.
Kramer, Douglas Java Whitepaper May 1996, WBX500.

* cited by examiner

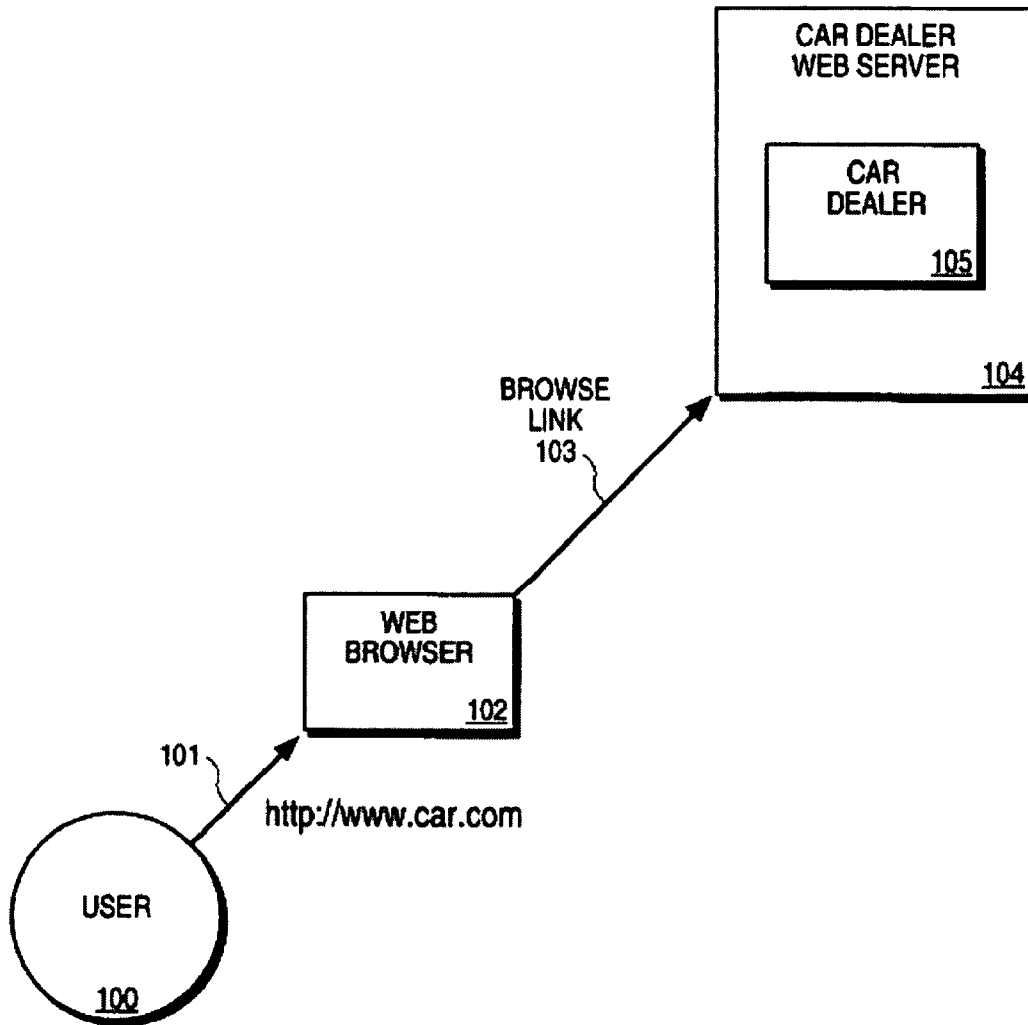

FIG. 1A (PRIOR ART)

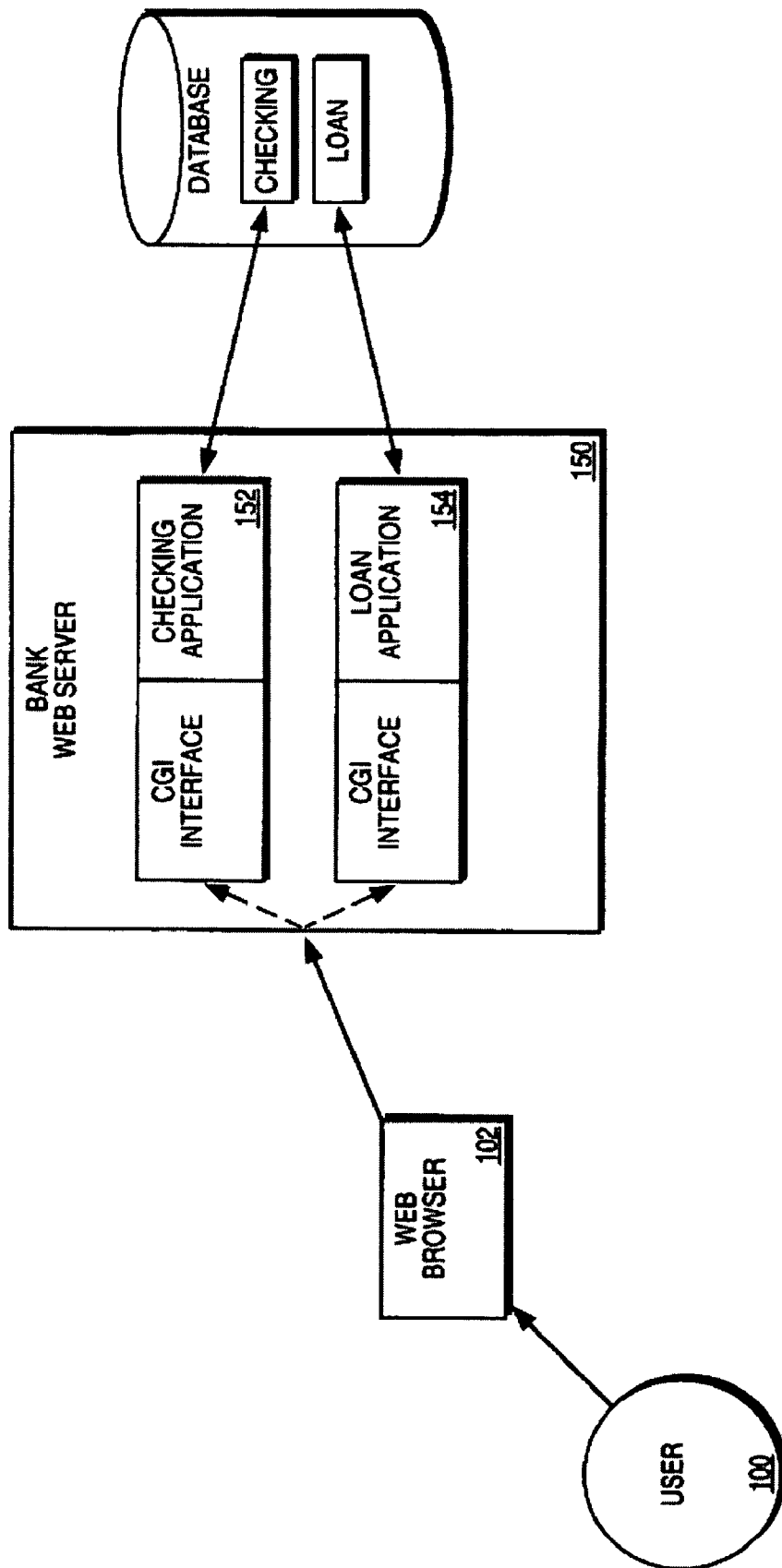

FIG. 1B (PRIOR ART)

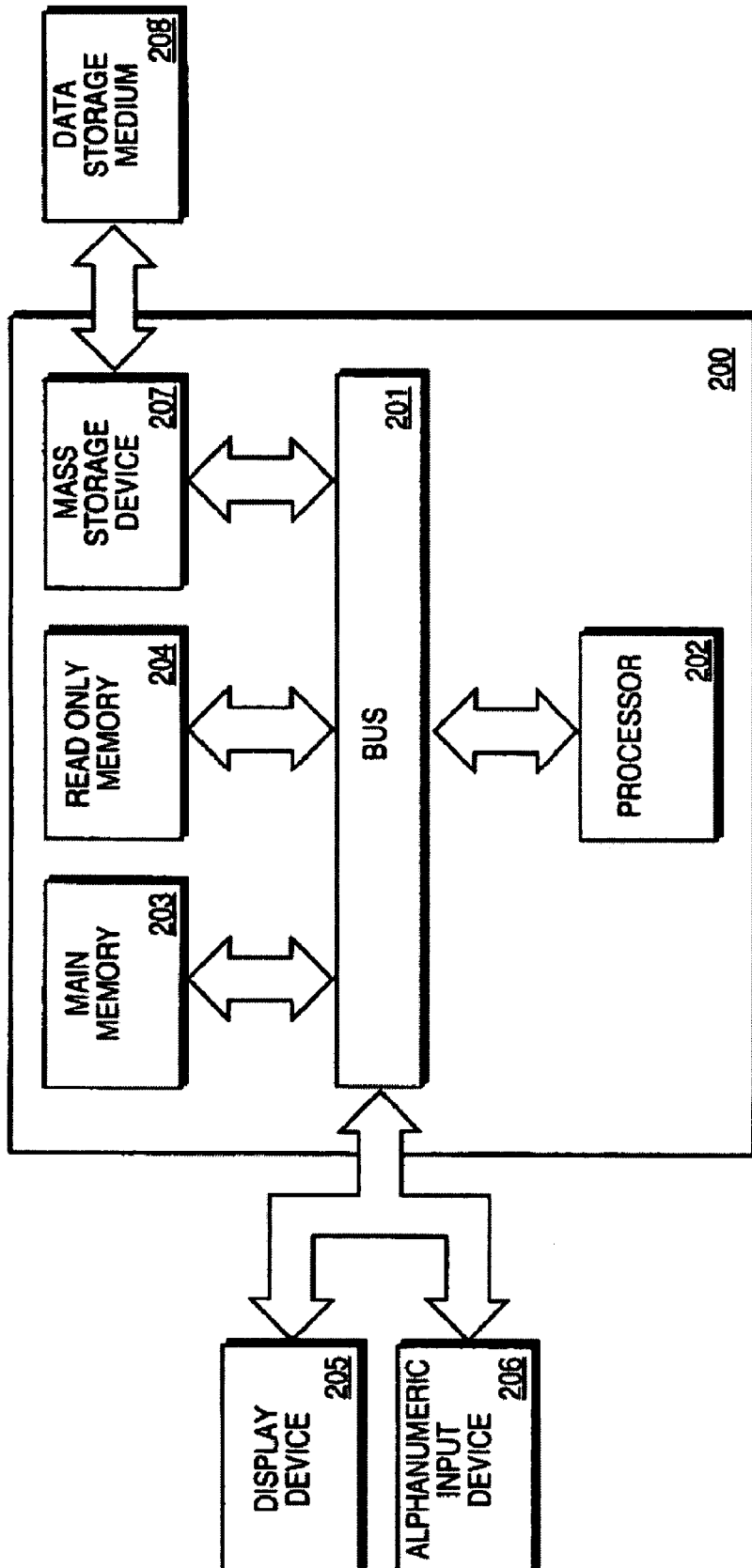

FIG. 2

OSI MODEL
300

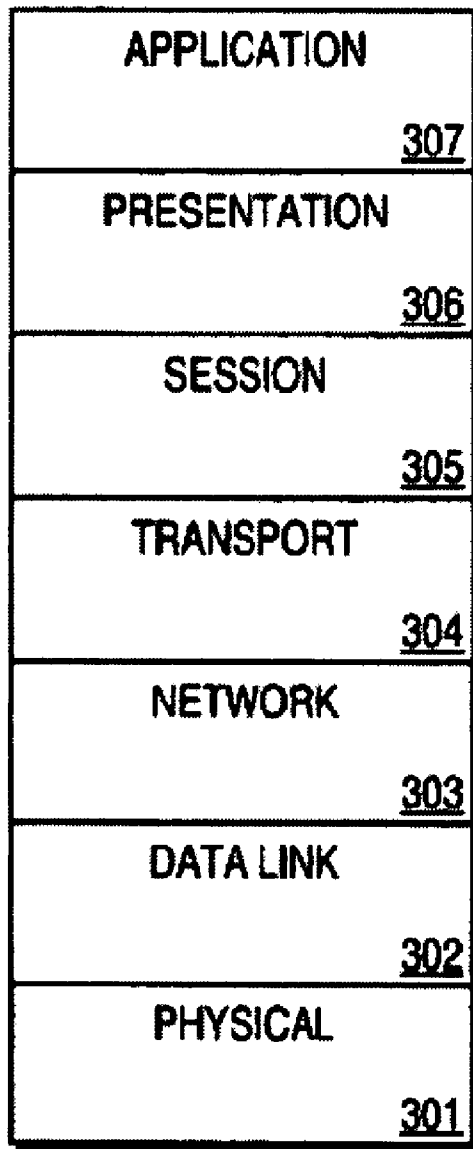

FIG. 3

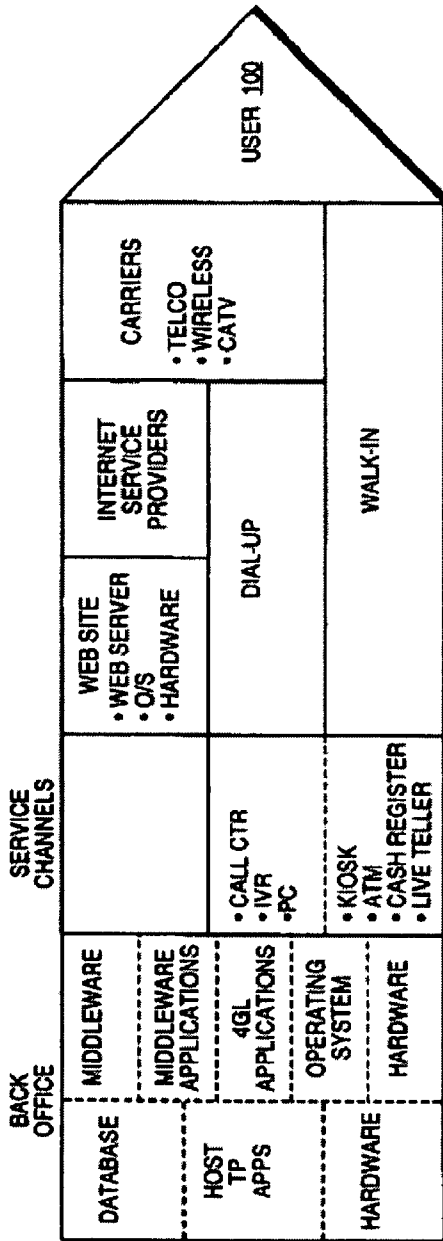

FIG. 4A

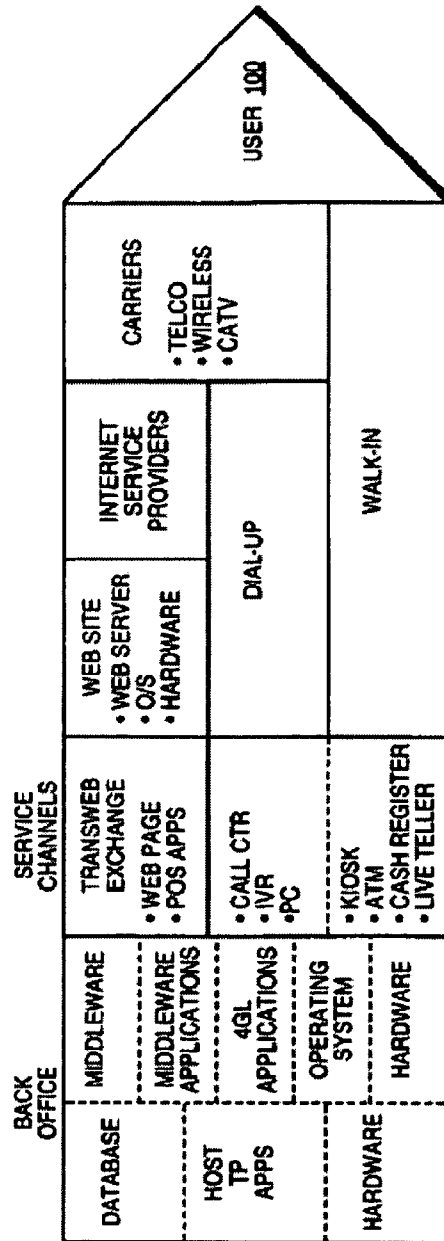

FIG. 4B

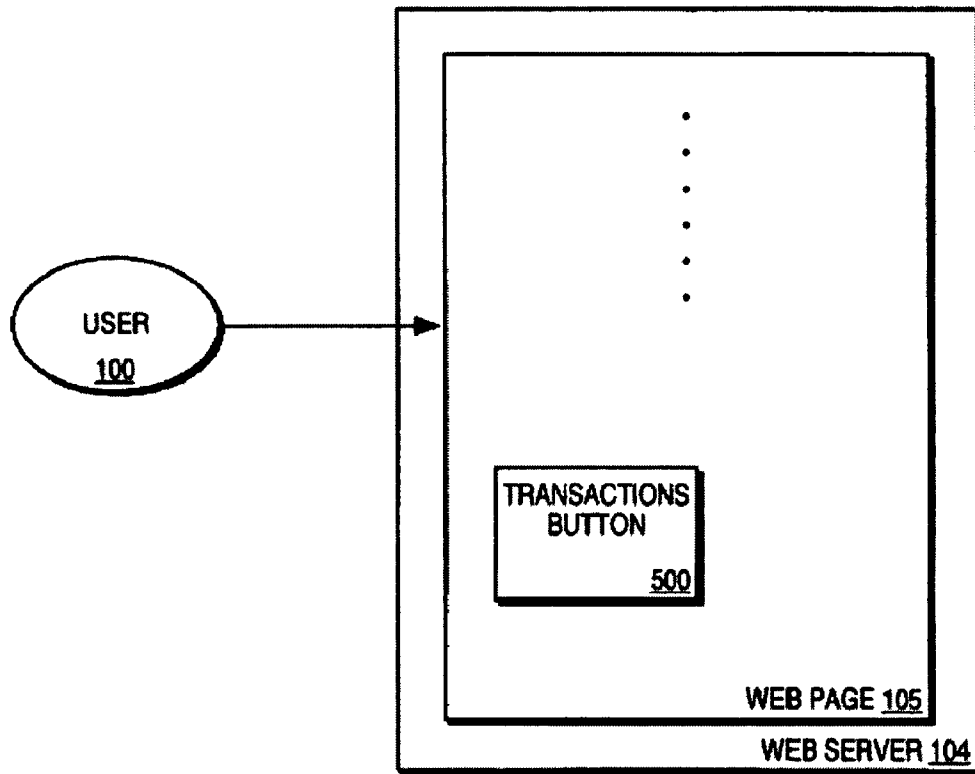

FIG. 5A

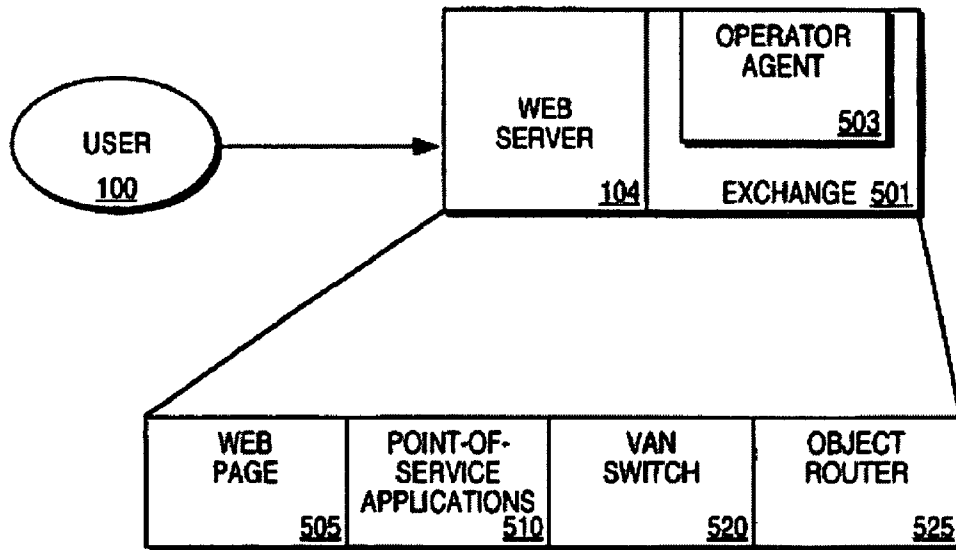

FIG. 5B

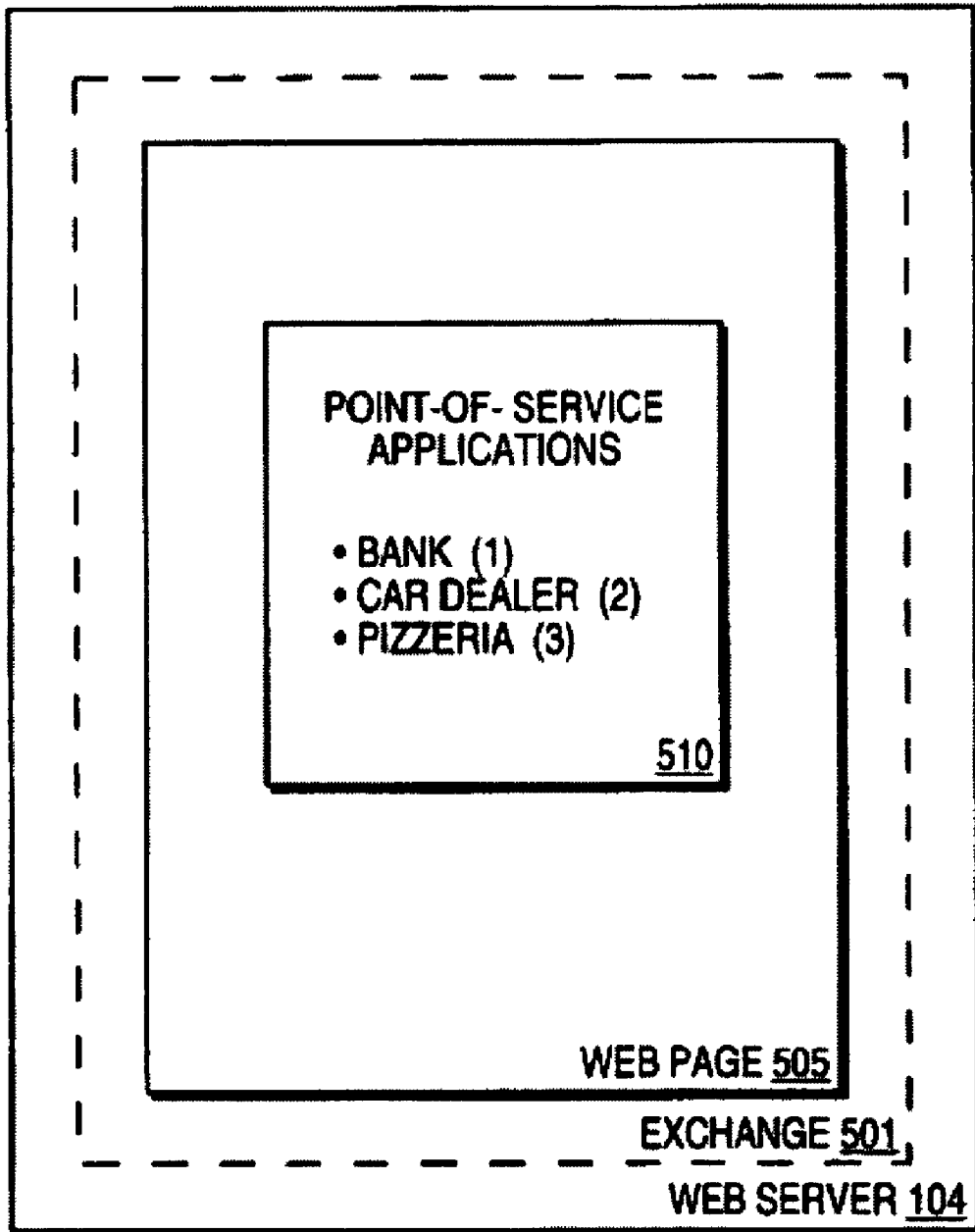

FIG. 5C

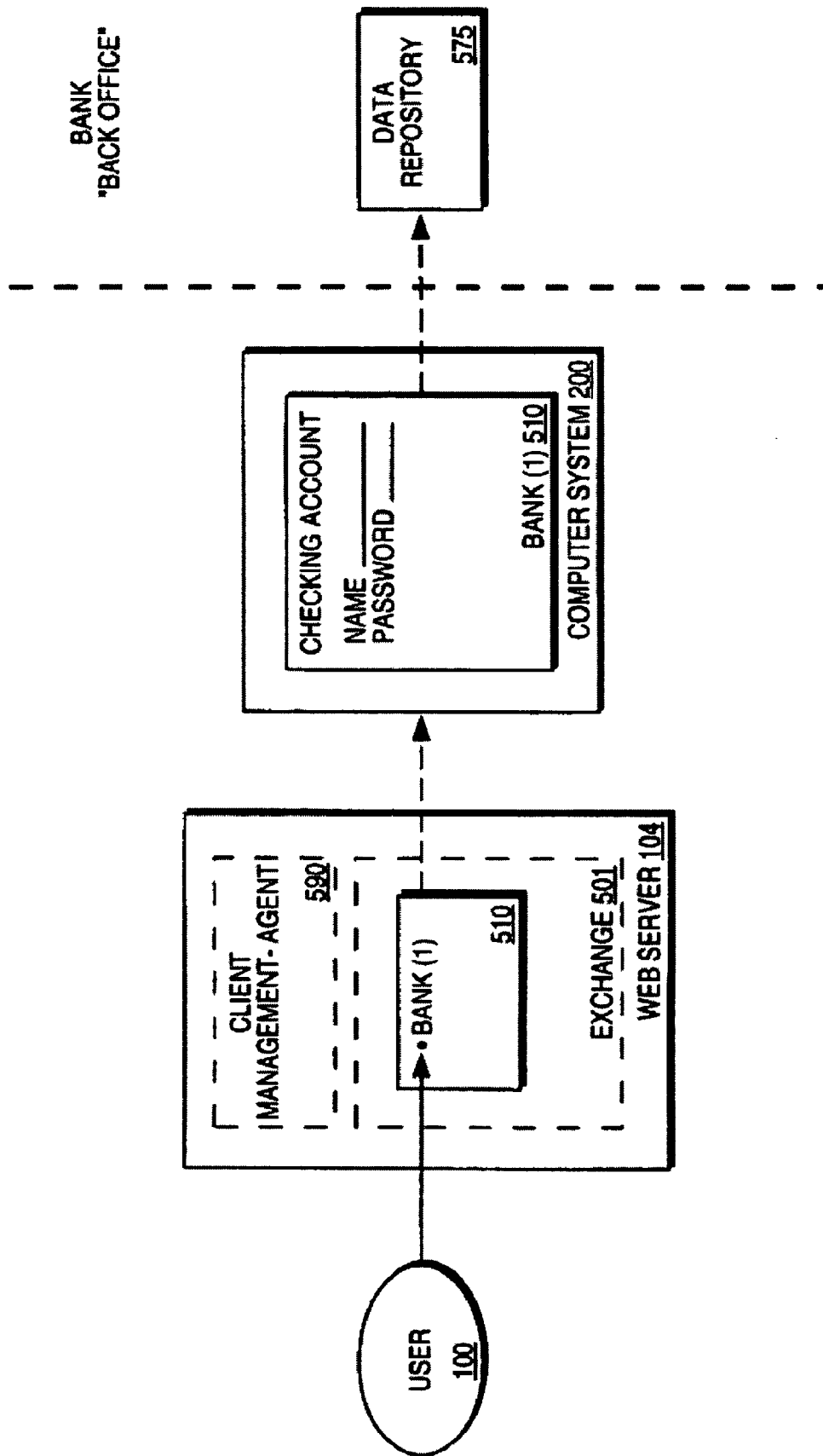

FIG. 5D

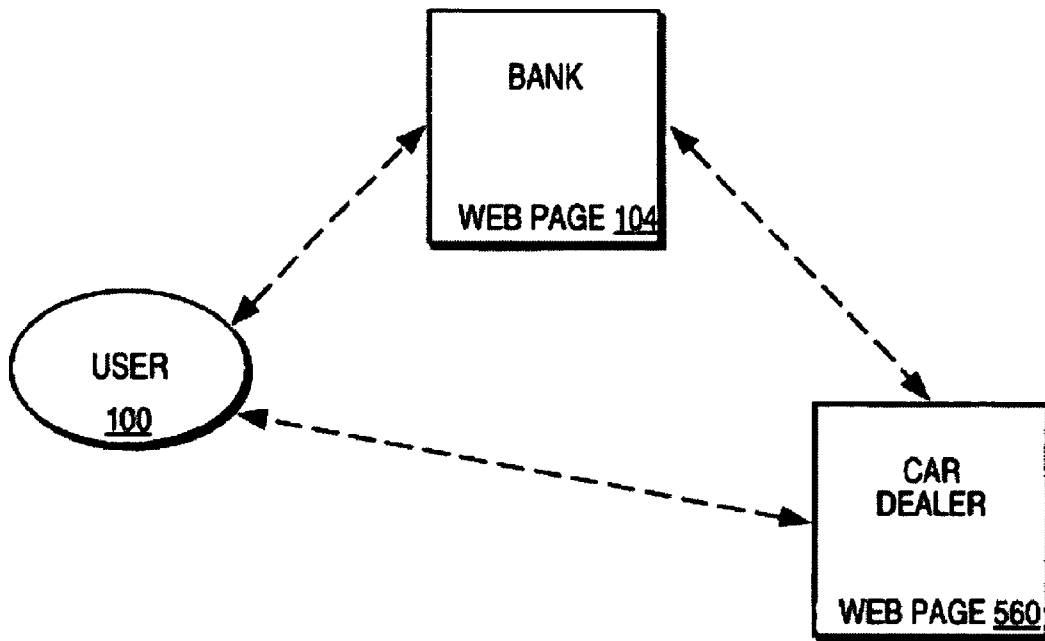

FIG. 5E

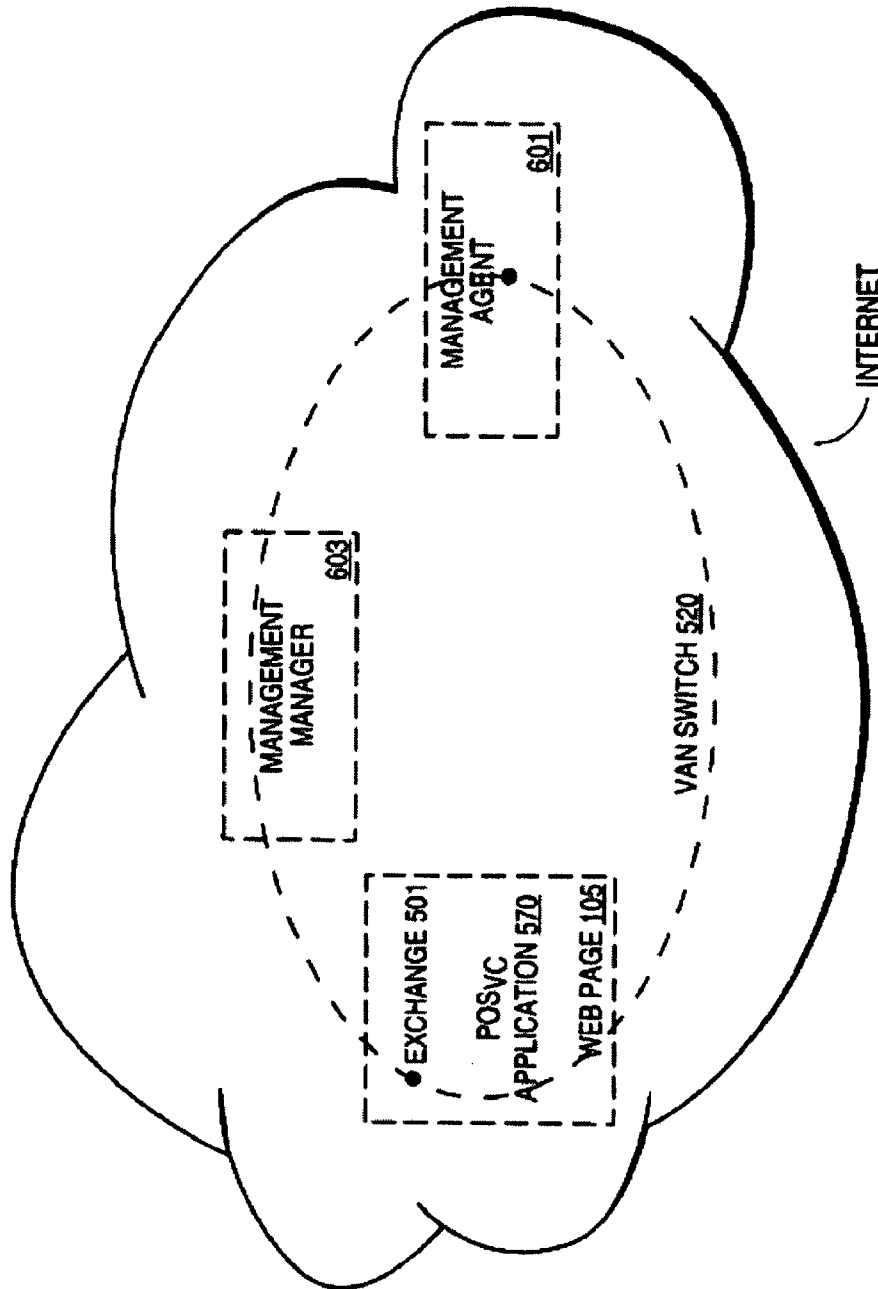

FIG. 6A

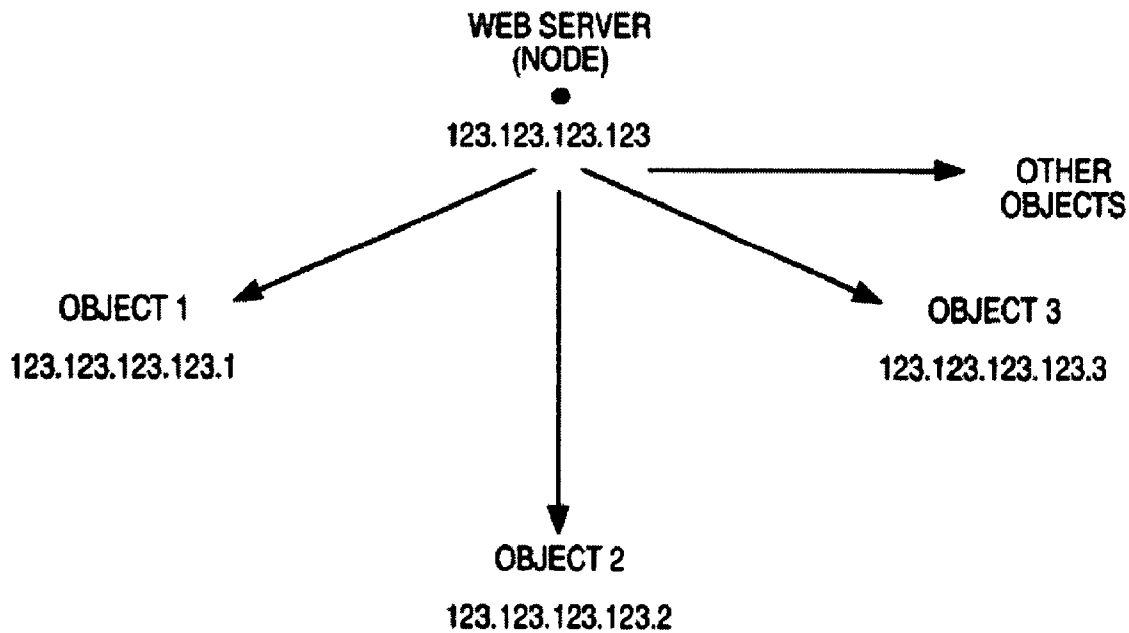

FIG. 6B

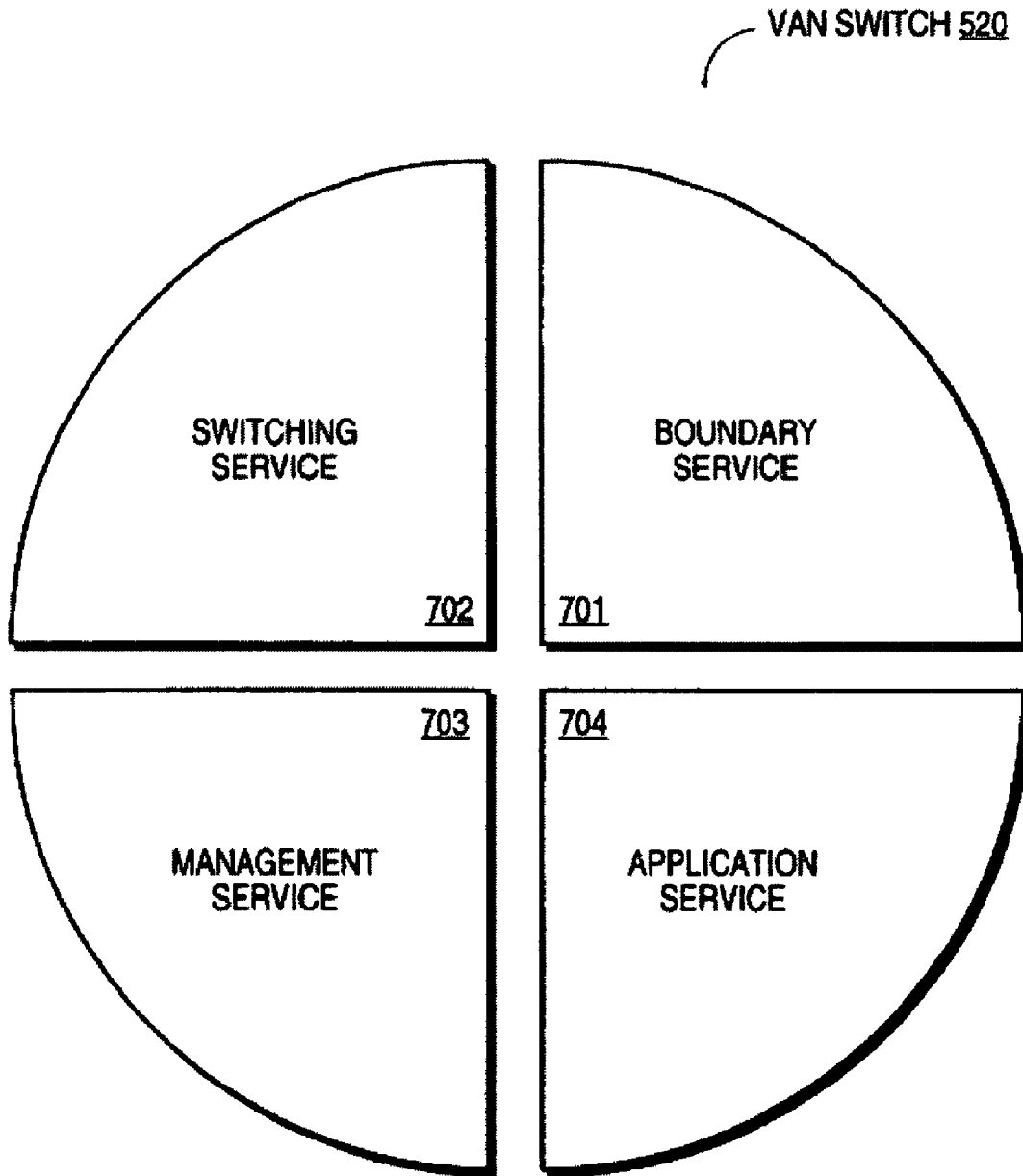

FIG. 7

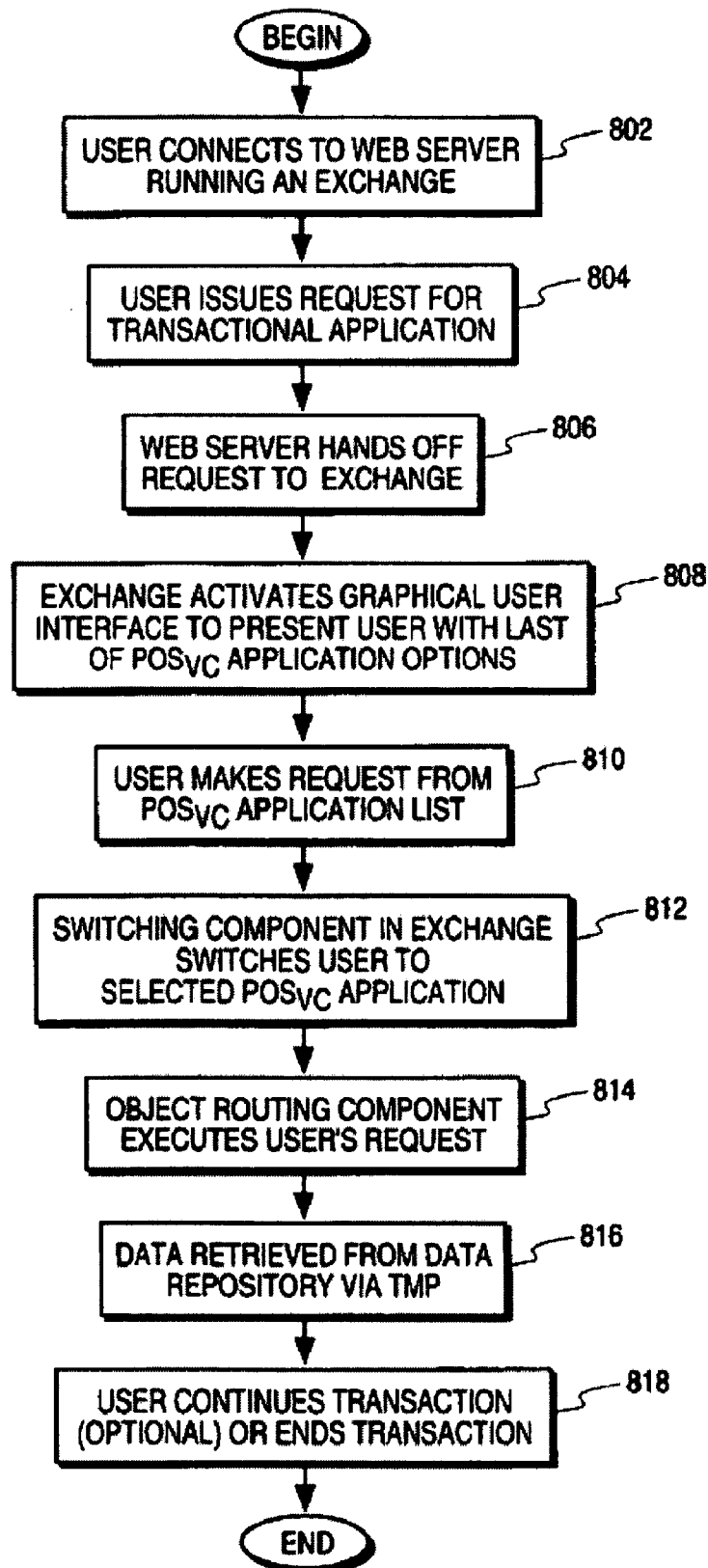

FIG. 8

US 8,108,492 B2

1

WEB APPLICATION NETWORK PORTAL

CROSS-REFERENCE TO RELATED APPLICATIONS

This application is a divisional and claims the priority benefit of U.S. patent application Ser. No. 11/980,185 filed Oct. 30, 2007 now U.S. Pat. No. 8,037,158, which is a continuation-in-part of U.S. patent application Ser. No. 09/792,323, now U.S. Pat. No. 7,340,506, filed Feb. 23, 2001, which is a divisional of U.S. patent application Ser. No. 09/296,207, filed Apr. 21, 1999, now U.S. Pat. No. 6,212,556, which is a continuation-in-part of U.S. patent application Ser. No. 08/879,958, now U.S. Pat. No. 5,987,500, filed Jun. 20, 1997, which is a divisional and claims the priority benefit of U.S. patent application Ser. No. 08/700,726, now U.S. Pat. No. 5,778,178, filed Aug. 5, 1996, which claims the priority benefit of U.S. provisional application 60/006,634 filed Nov. 13, 1995. This application also claims benefit under 35 U.S.C. 119(e) to U.S. Provisional application Ser. No. 60/006,634 filed Nov. 13, 1995. The following applications are related applications: application Ser. Nos. 09/863,704; 12/628,066; 12/628,068; 12/628,069, 12/932,758 and 60/206,422.

BACKGROUND

1. Field of the Invention

The present invention relates to the area of Internet communications. Specifically, the present invention relates to a method and apparatus for configurable value-added network switching and object routing.

2. Background of the Invention

With the Internet and the World Wide Web ("the Web") evolving rapidly as a viable consumer medium for electronic commerce, new on-line services are emerging to fill the needs of on-line users. An Internet user today can browse on the Web via the use of a Web browser. Web browsers are software interfaces that run on Web clients to allow access to Web servers via a simple user interface. A Web user's capabilities today from a Web browser are, however, extremely limited. The user can perform one-way, browse-only interactions. Additionally, the user has limited "deferred" transactional capabilities, namely electronic mail (e-mail) capabilities. E-mail capabilities are referred to as "deferred transactions" because the consumer's request is not processed until the e-mail is received, read, and the person or system reading the e-mail executes the transaction. This transaction is thus not performed in real-time.

FIG. 1A illustrates typical user interactions on the Web today. User **100** sends out a request from Web browser **102** in the form of a universal resource locator (URL) **101** in the following manner: <http://www.car.com>. URL **101** is processed by Web browser **102** that determines the URL corresponds to car dealer Web page **105**, on car dealer Web server **104**. Web browser **102** then establishes browse link **103** to car dealer Web page **105**. User **100** can browse Web page **105** and select "hot links" to jump to other locations in Web page **105**, or to move to other Web pages on the Web. This interaction is typically a browse-only interaction. Under limited circumstances, the user may be able to fill out a form on car dealer Web page **105**, and e-mail the form to car dealer Web server **104**. This interaction is still strictly a one-way browse mode communications link, with the e-mail providing limited, deferred transactional capabilities.

Under limited circumstances, a user may have access to two-way services on the Web via Common Gateway Interface (CGI) applications. CGI is a standard interface for running

2

external programs on a Web server. It allows Web servers to create documents dynamically when the server receives a request from the Web browser. When the Web server receives a request for a document, the Web server dynamically executes the appropriate CGI script and transmits the output of the execution back to the requesting Web browser. This interaction can thus be termed a "two-way" transaction. It is a severely limited transaction, however, because each CGI application is customized for a particular type of application or service.

For example, as illustrated in FIG. 1B, user **100** may access bank **150**'s Web server and attempt to perform transactions on checking account **152** and to make a payment on loan account **154**. In order for user **100** to access checking account **152** and loan account **154** on the Web, CGI application scripts must be created for each account, as illustrated in FIG. 1B. The bank thus has to create individual scripts for each of its services to offer users access to these services. User **100** can then interact in a limited fashion with these individual applications. Creating and managing individual CGI scripts for each service is not a viable solution for merchants with a large number of services.

As the Web expands and electronic commerce becomes more desirable, the need increases for robust, real-time, bi-directional transactional capabilities on the Web. A true real-time, bi-directional transaction would allow a user to connect to a variety of services on the Web, and perform real-time transactions on those services. For example, although user **100** can browse car dealer Web page **105** today, the user cannot purchase the car, negotiate a car loan or perform other types of real-time, two-way transactions that he can perform with a live salesperson at the car dealership. Ideally, user **100** in FIG. 1A would be able to access car dealer Web page **105**, select specific transactions that he desires to perform, such as purchase a car, and perform the purchase in real-time, with two-way interaction capabilities. CGI applications provide user **100** with a limited ability for two-way interaction with car dealer Web page **105**, but due to the lack of interaction and management between the car dealer and the bank, he will not be able to obtain a loan and complete the purchase of the car via a CGI application. The ability to complete robust real-time, two-way transactions is thus not truly available on the Web today.

SUMMARY OF THE INVENTION

It is therefore an object of the present invention to provide a method and apparatus for providing real-time, two-way transactional capabilities on the Web. Specifically, one embodiment of the present invention discloses a configurable value-added network switch for enabling real-time transactions on the World Wide Web. The configurable value added network switch comprises means for switching to a transactional application in response to a user specification from a World Wide Web application, means for transmitting a transaction request from the transactional application, and means for processing the transaction request.

According to another aspect of the present invention, a method and apparatus for enabling object routing on the World Wide Web is disclosed. The method for enabling object routing comprises the steps of creating a virtual information store containing information entries and attributes, associating each of the information entries and the attributes with an object identity, and assigning a unique network address to each of the object identities.

US 8,108,492 B2

3

Other objects, features and advantages of the present invention will be apparent from the accompanying drawings and from the detailed description.

BRIEF DESCRIPTION OF THE DRAWINGS

The features and advantages of the present invention will be apparent from the accompanying drawings and from the detailed description of the present invention as set forth below.

FIG. 1A is an illustration of a current user's browse capabilities on the Web via a Web browser.

FIG. 1B is an illustration of a current user's capabilities to perform limited transactions on the Web via CGI applications.

FIG. 2 illustrates a typical computer system on which the present invention may be utilized.

FIG. 3 illustrates the Open Systems Interconnection (OSI) Model.

FIG. 4A illustrates conceptually the user value chain as it exists today.

FIG. 4B illustrates one embodiment of the present invention.

FIG. 5A illustrates a user accessing a Web server including one embodiment of the present invention.

FIG. 5B illustrates the exchange component according to one embodiment of the present invention.

FIG. 5C illustrates an example of a point-of-service (POSvc) application list.

FIG. 5D illustrates a user selecting a bank POSvc application from the POSvc application list.

FIG. 5E illustrates a three-way transaction according to one embodiment of the present invention.

FIG. 6A illustrates a value-added network (VAN) switch.

FIG. 6B illustrates the hierarchical addressing tree structure of the networked objects in DOLSIBs.

FIG. 7 illustrates conceptually the layered architecture of a VAN switch.

FIG. 8 is a flow diagram illustrating one embodiment of the present invention.

DETAILED DESCRIPTION

The present invention relates to a method and apparatus for configurable value-added network switching and object routing and management. "Web browser" as used in the context of the present specification includes conventional Web browsers such as NCSA Mosaic™ from NCSA and Netscape Mosaic™ from Netscape™. The present invention is independent of the Web browser being utilized and the user can use any Web browser, without modifications to the Web browser. In the following detailed description, numerous specific details are set forth in order to provide a thorough understanding of the present invention. It will be apparent to one of ordinary skill in the art, however, that these specific details need not be used to practice the present invention. In other instances, well-known structures, interfaces and processes have not been shown in detail in order not to unnecessarily obscure the present invention.

FIG. 2 illustrates a typical computer system 200 in which the present invention operates. The preferred embodiment of the present invention is implemented on an IBM™ Personal Computer manufactured by IBM Corporation of Armonk, N.Y. Alternate embodiments may be implemented on a Macintosh™ computer manufactured by Apple™ Computer, Incorporated of Cupertino, Calif. It will be apparent to those

4

of ordinary skill in the art that other alternative computer system architectures may also be employed.

In general, such computer systems as illustrated by FIG. 2 comprise a bus 201 for communicating information, a processor 202 coupled with the bus 201 for processing information, main memory 203 coupled with the bus 201 for storing information and instructions for the processor 202, a read-only memory 204 coupled with the bus 201 for storing static information and instructions for the processor 202, a display device 205 coupled with the bus 201 for displaying information for a computer user, an input device 206 coupled with the bus 201 for communicating information and command selections to the processor 202, and a mass storage device 207, such as a magnetic disk and associated disk drive, coupled with the bus 201 for storing information and instructions. A data storage medium 208 containing digital information is configured to operate with mass storage device 207 to allow processor 202 access to the digital information on data storage medium 208 via bus 201.

Processor 202 may be any of a wide variety of general purpose processors or microprocessors such as the Pentium™ microprocessor manufactured by Intel™ Corporation or the Motorola™ 68040 or Power PC™ brand microprocessor manufactured by Motorola™ Corporation. It will be apparent to those of ordinary skill in the art, however, that other varieties of processors may also be used in a particular computer system. Display device 205 may be a liquid crystal device, cathode ray tube (CRT), or other suitable display device. Mass storage device 207 may be a conventional hard disk drive, floppy disk drive, CD-ROM drive, or other magnetic or optical data storage device for reading and writing information stored on a hard disk, a floppy disk, a CD-ROM a magnetic tape, or other magnetic or optical data storage medium. Data storage medium 208 may be a hard disk, a floppy disk, a CD-ROM, a magnetic tape, or other magnetic or optical data storage medium.

In general, processor 202 retrieves processing instructions and data from a data storage medium 208 using mass storage device 207 and downloads this information into random access memory 203 for execution. Processor 202, then executes an instruction stream from random access memory 203 or read-only memory 204. Command selections and information input at input device 206 are used to direct the flow of instructions executed by processor 202. Equivalent input device 206 may also be a pointing device such as a conventional mouse or trackball device. The results of this processing execution are then displayed on display device 205.

The preferred embodiment of the present invention is implemented as a software module, which may be executed on a computer system such as computer system 200 in a conventional manner. Using well known techniques, the application software of the preferred embodiment is stored on data storage medium 208 and subsequently loaded into and executed within computer system 200. Once initiated, the software of the preferred embodiment operates in the manner described below.

FIG. 3 illustrates the Open Systems Interconnection (OSI) reference model. OSI Model 300 is an international standard that provides a common basis for the coordination of standards development, for the purpose of systems interconnection. The present invention is implemented to function as a routing switch within the "application layer" of the OSI model. The model defines seven layers, with each layer communicating with its peer layer in another node through the use of a protocol. Physical layer 301 is the lowest layer, with responsibility to transmit unstructured bits across a link. Data

link layer **302** is the next layer above physical layer **301**. Data link layer **302** transmits chunks across the link and deals with problems like checksumming to detect data corruption, orderly coordination of the use of shared media and addressing when multiple systems are reachable. Network bridges operate within data link layer **302**.

Network layer **303** enables any pair of systems in the network to communicate with each other. Network layer **303** contains hardware units such as routers that handle routing, packet fragmentation and reassembly of packets. Transport layer **304** establishes a reliable communication stream between a pair of systems, dealing with errors such as lost packets, duplicate packets, packet reordering and fragmentation. Session layer **305** offers services above the simple communication stream provided by transport layer **304**. These services include dialog control and chaining. Presentation layer **306** provides a means by which OSI compliant applications can agree on representations for data. Finally, application layer **307** includes services such as file transfer, access and management services (FTAM), electronic mail and virtual terminal (VT) services. Application layer **307** provides a means for application programs to access the OSI environment. As described above, the present invention is implemented to function as a routing switch in application layer **307**. Application layer routing creates an open channel for the management, and the selective flow of data from remote databases on a network.

A. Overview

FIG. **4A** illustrates conceptually the user value chain as it exists today. The user value chain in FIG. **4A** depicts the types of transactions that are performed today, and the channels through which the transactions are performed. A “transaction” for the purposes of the present invention includes any type of commercial or other type of interaction that a user may want to perform. Examples of transactions include a deposit into a bank account, a request for a loan from a bank, a purchase of a car from a car dealership or a purchase of a car with financing from a bank. A large variety of other transactions are also possible.

A typical user transaction today may involve user **100** walking into a bank or driving up to a teller machine, and interacting with a live bank teller, or automated teller machine (ATM) software applications. Alternatively, user **100** can perform the same transaction by using a personal computer (PC), activating application software on his PC to access his bank account, and dialing into the bank via a modem line. If user **100** is a Web user, however, there is no current mechanism for performing a robust, real-time transaction with the bank, as illustrated in FIG. **4A**. CGI scripts provide only limited two-way capabilities, as described above. Thus, due to this lack of a robust mechanism by which real-time Web transactions can be performed, the bank is unable to be a true “Web merchant,” namely a merchant capable of providing complete transactional services on the Web.

According to one embodiment of the present invention, as illustrated in FIG. **4B**, each merchant that desires to be a Web merchant can provide real-time transactional capabilities to users who desire to access the merchants’ services via the Web. This embodiment includes a service network running on top of a facilities network, namely the Internet, the Web or e-mail networks. For the purposes of this application, users are described as utilizing PC’s to access the Web via Web server “switching” sites. (Switching is described in more detail below). Users may also utilize other personal devices such as network computers or cellular devices to access the merchants’ services via appropriate switching sites. These switching sites include non-Web network computer sites and

cellular provider sites. Five components interact to provide this service network functionality, namely an exchange, an operator agent, a management agent, a management manager and a graphical user interface. All five components are described in more detail below.

As illustrated in FIG. **5A**, user **100** accesses Web server **104**. Having accessed Web server **104**, user **100** can decide that he desires to perform real-time transactions. When Web server **104** receives user **100**’s indication that he desires to perform real-time transactions, the request is handed over to an exchange component. Thus, from Web page **105**, for example, user **100** can select button **500**, entitled “Transactions” and Web server **104** hands user **100**’s request over to the exchange component. The button and the title can be replaced by any mechanism that can instruct a Web server to hand over the consumer’s request to the exchange component.

FIG. **5B** illustrates exchange **501**. Exchange **501** comprises Web page **505** and point-of-service (POSvc) applications **510**. Exchange **501** also conceptually includes a switching component and an object routing component (described in more detail below). POSvc applications **510** are transactional applications, namely applications that are designed to incorporate and take advantage of the capabilities provided by the present invention. Although exchange **501** is depicted as residing on Web server **104**, the exchange can also reside on a separate computer system that resides on the Internet and has an Internet address. Exchange **501** may also include operator agent **503** that interacts with a management manager (described in more detail below). Exchange **501** creates and allows for the management (or distributed control) of a service network, operating within the boundaries of an IP-based facilities network. Thus, exchange **501** and a management agent component, described in more detail below, under the headings “VAN Switch and Object Routing,” together perform the switching, object routing, application and service management functions according to one embodiment of the present invention.

Exchange **501** processes the consumer’s request and displays an exchange Web page **505** that includes a list of POSvc applications **510** accessible by exchange **501**. A POSvc application is an application that can execute the type of transaction that the user may be interested in performing. The POSvc list is displayed via the graphical user interface component. One embodiment of the present invention supports Hyper-Text Markup Language as the graphical user interface component. Virtual Reality Markup Language and Java™ are also supported by this embodiment. A variety of other graphical user interface standards can also be utilized to implement the graphical user interface.

An example of a POSvc application list is illustrated in FIG. **5C**. User **100** can thus select from POSvc applications Bank **510(1)**, Car Dealer **510(2)** or Pizzeria **510(3)**. Numerous other POSvc applications can also be included in this selection. If user **100** desires to perform a number of banking transactions, and selects the Bank application, a Bank POSvc application will be activated and presented to user **100**, as illustrated in FIG. **5D**. For the purposes of illustration, exchange **501** in FIG. **5D** is shown as running on a different computer system (Web server **104**) from the computer systems of the Web merchants running POSvc applications (computer system **200**). Exchange **501** may, however, also be on the same computer system as one or more of the computer systems of the Web merchants.

Once Bank POSvc application **510** has been activated, user **100** will be able to connect to Bank services and utilize the application to perform banking transactions, thus accessing

data from a host or data repository **575** in the Bank “Back Office.” The Bank Back Office comprises legacy databases and other data repositories that are utilized by the Bank to store its data. This connection between user **100** and Bank services is managed by exchange **501**. As illustrated in FIG. **5D**, once the connection is made between Bank POSvc application **510(1)**, for example, and Bank services, an operator agent on Web server **104** may be activated to ensure the availability of distributed functions and capabilities.

Each Web merchant may choose the types of services that it would like to offer its clients. In this example, if Bank decided to include in their POSvc application access to checking and savings accounts, user **100** will be able to perform real-time transactions against his checking and savings accounts. Thus, if user **100** moves \$500 from his checking account into his savings account, the transaction will be performed in real-time, in the same manner the transaction would have been performed by a live teller at the bank or an ATM machine. Therefore, unlike his prior access to his account, user **100** now has the capability to do more than browse his bank account. The ability to perform these types of robust, real-time transactions from a Web client is a significant aspect of the present invention.

Bank can also decide to provide other types of services in POSvc application **510(1)**. For example, Bank may agree with Car dealership to allow Bank customers to purchase a car from that dealer, request a car loan from Bank, and have the entire transaction performed on the Web, as illustrated in FIG. **5E**. In this instance, the transactions are not merely two-way, between the user and Bank, but three-way, amongst the consumer, Bank and Car dealership. According to one aspect of the present invention, this three-way transaction can be expanded to n-way transactions, where n represents a predetermined number of merchants or other service providers who have agreed to cooperate to provide services to users. The present invention therefore allows for “any-to-any” communication and transactions on the Web, thus facilitating a large, flexible variety of robust, real-time transactions on the Web.

Finally, Bank may also decide to provide intra-merchant or intra-bank services, together with the inter-merchant services described above. For example, if Bank creates a POSvc application for use by the Bank Payroll department, Bank may provide its own employees with a means for submitting time-cards for payroll processing by the Bank’s Human Resources (HR) Department. An employee selects the Bank HR POSvc application, and submits his timecard. The employee’s timecard is processed by accessing the employee’s payroll information, stored in the Bank’s Back Office. The transaction is thus processed in real-time, and the employee receives his paycheck immediately.

B. Van Switching and Object Routing

As described above, exchange **501** and management agent **601**, illustrated in FIG. **6A**, together constitute a value-added network (VAN) switch. These two elements may take on different roles as necessary, including peer-to-peer, client-server or master-slave roles. Management manager **603** is illustrated as residing on a separate computer system on the Internet. Management manager **603** can, however, also reside on the same machine as exchange **501**. Management manager **603** interacts with the operator agent **503** residing on exchange **501**.

VAN switch **520** provides multi-protocol object routing, depending upon the specific VAN services chosen. This multi-protocol object routing is provided via a proprietary protocol, TransWeb™ Management Protocol (TMP). TMP incorporates the same security features as the traditional Simple Network Management Protocol, SNMP. It also allows

for the integration of other traditional security mechanisms, including RSA security mechanisms.

One embodiment of the present invention utilizes TMP and distributed on-line service information bases (DOLSIBs) to perform object routing. Alternatively, TMP can incorporate s-HTTP, Java™, the WinSock API or ORB with DOLSIBs to perform object routing. DOLSIBs are virtual information stores optimized for networking. All information entries and attributes in a DOLSIB virtual information store are associated with a networked object identity. The networked object identity identifies the information entries and attributes in the DOLSIB as individual networked objects, and each networked object is assigned an Internet address. The Internet address is assigned based on the IP address of the node at which the networked object resides.

For example, in FIG. **5A**, Web server **104** is a node on the Internet, with an IP address. All networked object associated with Web server **104** will therefore be assigned an Internet address based on the Web server **104**’s IP address. These networked objects thus “branch” from the node, creating a hierarchical tree structure. The Internet address for each networked object in the tree essentially establishes the individual object as an “IP-reachable” or accessible node on the Internet. TMP utilizes this Internet address to uniquely identify and access the object from the DOLSIB. FIG. **6B** illustrates an example of this hierarchical addressing tree structure.

Each object in the DOLSIB has a name, a syntax and an encoding. The name is an administratively assigned object ID specifying an object type. The object type together with the object instance serves to uniquely identify a specific instantiation of the object. For example, if object **610** is information about models of cars, then one instance of that object would provide user **100** with information about a specific model of the car while another instance would provide information about a different model of the car. The syntax of an object type defines the abstract data structure corresponding to that object type. Encoding of objects defines how the object is represented by the object type syntax while being transmitted over the network.

C. Management and Administration

As described above, exchange **501** and management agent **601** together constitute a VAN switch. FIG. **7** illustrates conceptually the layered architecture of VAN switch **520**. Specifically, boundary service **701** provides the interfaces between VAN switch **520**, the Internet and the Web, and multi-media end user devices such as PCs, televisions or telephones. Boundary service **701** also provides the interface to the on-line service provider. A user can connect to a local application, namely one accessible via a local VAN switch, or be routed or “switched” to an application accessible via a remote VAN switch.

Switching service **702** is an OSI application layer switch. Switching service **702** thus represents the core of the VAN switch. It performs a number of tasks including the routing of user connections to remote VAN switches, described in the paragraph above, multiplexing and prioritization of requests, and flow control. Switching service **702** also facilitates open systems’ connectivity with both the Internet (a public switched network) and private networks including back office networks, such as banking networks. Interconnected application layer switches form the application network backbone. These switches are one significant aspect of the present invention.

Management service **703** contains tools such as Information Management Services (IMS) and application Network Management Services (NMS). These tools are used by the end users to manage network resources, including VAN

US 8,108,492 B2

9

switches. Management service 703 also provides applications that perform Operations, Administration, Maintenance & Provisioning (OAM&P) functions. These OAM&P functions include security management, fault management, configuration management, performance management and billing management. Providing OAM&P functions for applications in this manner is another significant aspect of the present invention.

Finally, application service 704 contains application programs that deliver customer services. Application service 704 includes POSvc applications such as Bank POSvc described above, and illustrated in FIG. 6A. Other examples of VAN services include multi-media messaging, archival/retrieval management, directory services, data staging, conferencing, financial services, home banking, risk management and a variety of other vertical services. Each VAN service is designed to meet a particular set of requirements related to performance, reliability, maintenance and ability to handle expected traffic volume. Depending on the type of service, the characteristics of the network elements will differ. VAN service 704 provides a number of functions including communications services for both management and end users of the network and control for the user over the user's environment.

FIG. 8 is a flow diagram illustrating one embodiment of the present invention. A user connects to a Web server running an exchange component in step 802. In step 804, the user issues a request for a transactional application, and the web server hands off the request to an exchange in step 806. The exchange activates a graphical user interface to present user with a list of POSvc application options in step 808. In step 810, the user makes a selection from the POSvc application list. In step 812, the switching component in the exchange switches the user to the selected POSvc application, and in step 814, the object routing component executes the user's request. Data is retrieved from the appropriate data repository via TMP in step 816, and finally, the user may optionally continue the transaction in step 818 or end the transaction.

Thus, a configurable value-added network switching and object routing method and apparatus is disclosed. These specific arrangements and methods described herein are merely illustrative of the principles of the present invention. Numerous modifications in form and detail may be made by those of ordinary skill in the art without departing from the scope of the present invention. Although this invention has been shown in relation to a particular preferred embodiment, it should not be considered so limited. Rather, the present invention is limited only by the scope of the appended claims.

What is claimed is:

1. A system, comprising:
 - a Web server, including a processor and a memory, for offering one or more Web applications as respective point-of-service applications in a point-of-service application list on a Web page;
 - each Web application of the one or more Web applications for requesting a real-time Web transaction;
 - a value-added network (VAN) switch running on top of a facilities network selected from a group consisting of the World Wide Web, the Internet and an e-mail network, the VAN switch for enabling the real-time Web transactions from the one or more Web applications;
 - a service network running on top of the facilities network for connecting through the Web server to a back-end transactional application; and
 - a computer system executing the Back-end transactional application for processing the transaction request in real-time.

10

2. The system of claim 1, wherein the VAN switch is an application layer switch in the application layer of the OSI model.

3. The system of claim 1, wherein the VAN switch enables the switching to Web merchant services in response to a Web server's receipt of a selection of one of the point-of-service Web applications corresponding to the Web merchant services from the point-of-service application list on the Web page.

4. The system of claim 1, wherein each Web merchant service includes one of the one or more Web applications offered as a VAN service, utilizing the VAN switch.

5. The system of claim 1, wherein each Web application of the one or more Web applications is a value-added network (VAN) service or online service atop the Web, utilizing the VAN switch.

6. The system of claim 1, wherein the service network includes the one or more Web applications and wherein the service network manages the flow of real-time Web transactions from the one or more Web applications and includes the VAN switch.

7. The system of claim 1, wherein the Web server is configured to receive a Web transaction request and wherein the Web transaction request is a request to perform one of the real-time Web transactions from one of the one or more Web applications, utilizing the VAN switch.

8. The system of claim 1, further comprising:

a computer system executing a back-end transactional application for processing the transaction request in real-time, wherein said computer system includes a data repository, wherein the data repository is a data repository to store banking data, and wherein retrieving data includes retrieving banking data to complete a real-time Web banking transaction as one of the real-time Web transactions from a banking Web application as one of the one or more Web applications.

9. The system of claim 1, further comprising the one or more Web applications offered as software-as-a-service atop the Web.

10. A method for performing real-time Web transactions from a Web application, comprising:

receiving a request at a Web server, including a processor and a memory, for a real-time Web transaction from a Web application on a Web page, wherein the Web server is configured to hand over the request to a Value Added Network (VAN) switch;

offering a plurality of Web applications including the Web application on a Web page, upon receipt from a Web server a selection of the Web application from the offered Web applications, the Web application corresponding to a respective back-end transactional application, wherein the back-end transactional application is an application running at the back-office server of one or more Web merchants or at the back-end;

receiving a request for Web merchant services upon receipt by a Web server a selection of the Web application, wherein the request for Web merchant services is a request to connect to the selected back-end transactional application to perform an interactive real-time Web transaction from the Web application, wherein the transactional application is an on-line service provided by one or more Web merchants or the back-end;

switching utilizing the VAN switch to the back-end transactional application in response to receiving the request from the Web server;

US 8,108,492 B2

11

providing distributed control of a service network, operating within the boundaries of an IP-based facilities network;
 connecting to specified ones of the Web merchant services or to back-end services, wherein the connection to the Web merchant services or back-end transactional services is managed;
 accessing data from a host or data repository coupled to the back office server of one or more Web merchants or to the back-end transactional application, wherein the back office server or back-end is coupled to legacy databases and other data repositories that are utilized by the one or more of the Web merchants or the back-end transactional application to store data; and
 completing the real-time Web transactions from the Web application.

11. The method of claim 10, wherein the real-time Web transactions are Web transactions from the Web application accessing a value-added network service.

12. A computer-implemented system, operated by a business entity comprising:

a Web application network portal, wherein the portal includes memory and a processor and one or more Web applications offered respectively by one or more Web merchants or other service providers, or by multiple sub-entities of the business entity who have agreed to cooperate to provide on-line Value Added Network (VAN) services atop the Web for access by employees of the business entity;

12

a list of one or more point-of-service employee Web applications on a Web page offered by the business entity that operates the portal, said portal allowing access to the one or more point-of-service applications on the Web page from said list, and wherein the portal offers the one or more point-of-service applications as on-line services on the Web page, and further wherein the portal is operated by the business entity over a service network running on top of a facilities network, the facilities network being selected from a group consisting of: the World Wide Web, the Internet and email networks, said service network including a VAN Switch;

one or more back-end transactional applications running at one or more back-end host computers, corresponding, respectively to the one or more point-of-service applications accessed, to complete a real-time Web transaction from the Web application on the Web page.

13. The portal of claim 12, wherein the one or more Web applications include a plurality of point-of-service applications on the Web page, wherein the business entity and the sub-entities offer Web applications which are selected from a group consisting of payroll Web applications, human resources Web applications, expense report Web applications, time card Web applications, travel Web applications, vacation Web applications, financial Web applications and sales commission Web applications.

* * * * *

**UNITED STATES DISTRICT COURT
CENTRAL DISTRICT OF CALIFORNIA**

NOTICE OF ASSIGNMENT TO UNITED STATES MAGISTRATE JUDGE FOR DISCOVERY

This case has been assigned to District Judge Dean D. Pregerson and the assigned discovery Magistrate Judge is Victor B. Kenton.

The case number on all documents filed with the Court should read as follows:

CV12- 9703 DDP (VBKx)

Pursuant to General Order 05-07 of the United States District Court for the Central District of California, the Magistrate Judge has been designated to hear discovery related motions.

All discovery related motions should be noticed on the calendar of the Magistrate Judge

=====

NOTICE TO COUNSEL

A copy of this notice must be served with the summons and complaint on all defendants (if a removal action is filed, a copy of this notice must be served on all plaintiffs).

Subsequent documents must be filed at the following location:

Western Division
312 N. Spring St., Rm. G-8
Los Angeles, CA 90012

Southern Division
411 West Fourth St., Rm. 1-053
Santa Ana, CA 92701-4516

Eastern Division
3470 Twelfth St., Rm. 134
Riverside, CA 92501

Failure to file at the proper location will result in your documents being returned to you.

John V. Picone III (SBN 187226)
jpicone@hopkinscarley.com
Hopkins & Carley, a Law Corporation
70 S. First Street, San Jose, CA 95113
Tel: (408) 286-9800
Fax: (408) 998-4790

UNITED STATES DISTRICT COURT
CENTRAL DISTRICT OF CALIFORNIA

PI-NET INTERNATIONAL, INC.,

PLAINTIFF(S)

v.

CAL POLY FEDERAL CREDIT UNION,

DEFENDANT(S).

CASE NUMBER

CV12-09703

DDP(VBKx)

SUMMONS

TO: DEFENDANT(S): CAL POLY FEDERAL CREDIT UNION

A lawsuit has been filed against you.

Within 21 days after service of this summons on you (not counting the day you received it), you must serve on the plaintiff an answer to the attached complaint _____ amended complaint counterclaim cross-claim or a motion under Rule 12 of the Federal Rules of Civil Procedure. The answer or motion must be served on the plaintiff's attorney, John V. Picone III, whose address is Hopkins & Carley, a Law Corp., 70 S. First Street, San Jose, CA 95113. If you fail to do so, judgment by default will be entered against you for the relief demanded in the complaint. You also must file your answer or motion with the court.

Clerk, U.S. District Court

NOV 13 2012

Dated: _____

By: _____

Deputy Clerk

(Seal of the Court)

[Use 60 days if the defendant is the United States or a United States agency, or is an officer or employee of the United States. Allowed 60 days by Rule 12(a)(3)].

UNITED STATES DISTRICT COURT, CENTRAL DISTRICT OF CALIFORNIA
CIVIL COVER SHEET

I (a) PLAINTIFFS (Check box if you are representing yourself <input type="checkbox"/>) PI NET INTERNATIONAL, INC.	DEFENDANTS CAL POLY FEDERAL CREDIT UNION
(b) Attorneys (Firm Name, Address and Telephone Number. If you are representing yourself, provide same.) John V. Picone III, Jennifer S. Coleman HOPKINS & CARLEY, P.O. Box 1469, San Jose, CA 95109-1469 (408) 286-9800	Attorneys (If Known)

II. BASIS OF JURISDICTION (Place an X in one box only.) <input type="checkbox"/> 1 U.S. Government Plaintiff <input checked="" type="checkbox"/> 3 Federal Question (U.S. Government Not a Party) <input type="checkbox"/> 2 U.S. Government Defendant <input type="checkbox"/> 4 Diversity (Indicate Citizenship of Parties in Item III)	III. CITIZENSHIP OF PRINCIPAL PARTIES - For Diversity Cases Only (Place an X in one box for plaintiff and one for defendant.) <table style="width:100%; border-collapse: collapse;"> <tr> <td style="width:30%;"></td> <td style="width:10%; text-align: center;">PTF</td> <td style="width:10%; text-align: center;">DEF</td> <td style="width:40%;"></td> <td style="width:10%; text-align: center;">PTF</td> <td style="width:10%; text-align: center;">DEF</td> </tr> <tr> <td>Citizen of This State</td> <td style="text-align: center;"><input type="checkbox"/> 1</td> <td style="text-align: center;"><input type="checkbox"/> 1</td> <td>Incorporated or Principal Place of Business in this State</td> <td style="text-align: center;"><input checked="" type="checkbox"/> 4</td> <td style="text-align: center;"><input checked="" type="checkbox"/> 4</td> </tr> <tr> <td>Citizen of Another State</td> <td style="text-align: center;"><input type="checkbox"/> 2</td> <td style="text-align: center;"><input type="checkbox"/> 2</td> <td>Incorporated and Principal Place of Business in Another State</td> <td style="text-align: center;"><input type="checkbox"/> 5</td> <td style="text-align: center;"><input type="checkbox"/> 5</td> </tr> <tr> <td>Citizen or Subject of a Foreign Country</td> <td style="text-align: center;"><input type="checkbox"/> 3</td> <td style="text-align: center;"><input type="checkbox"/> 3</td> <td>Foreign Nation</td> <td style="text-align: center;"><input type="checkbox"/> 6</td> <td style="text-align: center;"><input type="checkbox"/> 6</td> </tr> </table>		PTF	DEF		PTF	DEF	Citizen of This State	<input type="checkbox"/> 1	<input type="checkbox"/> 1	Incorporated or Principal Place of Business in this State	<input checked="" type="checkbox"/> 4	<input checked="" type="checkbox"/> 4	Citizen of Another State	<input type="checkbox"/> 2	<input type="checkbox"/> 2	Incorporated and Principal Place of Business in Another State	<input type="checkbox"/> 5	<input type="checkbox"/> 5	Citizen or Subject of a Foreign Country	<input type="checkbox"/> 3	<input type="checkbox"/> 3	Foreign Nation	<input type="checkbox"/> 6	<input type="checkbox"/> 6
	PTF	DEF		PTF	DEF																				
Citizen of This State	<input type="checkbox"/> 1	<input type="checkbox"/> 1	Incorporated or Principal Place of Business in this State	<input checked="" type="checkbox"/> 4	<input checked="" type="checkbox"/> 4																				
Citizen of Another State	<input type="checkbox"/> 2	<input type="checkbox"/> 2	Incorporated and Principal Place of Business in Another State	<input type="checkbox"/> 5	<input type="checkbox"/> 5																				
Citizen or Subject of a Foreign Country	<input type="checkbox"/> 3	<input type="checkbox"/> 3	Foreign Nation	<input type="checkbox"/> 6	<input type="checkbox"/> 6																				

IV. ORIGIN (Place an X in one box only.)

1 Original Proceeding
 2 Removed from State Court
 3 Remanded from Appellate Court
 4 Reinstated or Reopened
 5 Transferred from another district (specify):
 6 Multi-District Litigation
 7 Appeal to District Judge from Magistrate Judge

V. REQUESTED IN COMPLAINT: **JURY DEMAND:** Yes No (Check 'Yes' only if demanded in complaint.)

CLASS ACTION under F.R.C.P. 23: Yes No **MONEY DEMANDED IN COMPLAINT: \$** _____

VI. CAUSE OF ACTION (Cite the U.S. Civil Statute under which you are filing and write a brief statement of cause. Do not cite jurisdictional statutes unless diversity.)

35 U.S.C. 101 et seq

VII. NATURE OF SUIT (Place an X in one box only.)

OTHER STATUTES <input type="checkbox"/> 400 State Reapportionment <input type="checkbox"/> 410 Antitrust <input type="checkbox"/> 430 Banks and Banking <input type="checkbox"/> 450 Commerce/ICC Rates/etc. <input type="checkbox"/> 460 Deportation <input type="checkbox"/> 470 Racketeer Influenced and Corrupt Organizations <input type="checkbox"/> 480 Consumer Credit <input type="checkbox"/> 490 Cable/Sat TV <input type="checkbox"/> 810 Selective Service <input type="checkbox"/> 850 Securities/Commodities/Exchange <input type="checkbox"/> 875 Customer Challenge 12 USC 3410 <input type="checkbox"/> 890 Other Statutory Actions <input type="checkbox"/> 891 Agricultural Act <input type="checkbox"/> 892 Economic Stabilization Act <input type="checkbox"/> 893 Environmental Matters <input type="checkbox"/> 894 Energy Allocation Act <input type="checkbox"/> 895 Freedom of Info. Act <input type="checkbox"/> 900 Appeal of Fee Determination Under Equal Access to Justice <input type="checkbox"/> 950 Constitutionality of State Statutes	CONTRACT <input type="checkbox"/> 110 Insurance <input type="checkbox"/> 120 Marine <input type="checkbox"/> 130 Miller Act <input type="checkbox"/> 140 Negotiable Instrument <input type="checkbox"/> 150 Recovery of Overpayment & Enforcement of Judgment <input type="checkbox"/> 151 Medicare Act <input type="checkbox"/> 152 Recovery of Defaulted Student Loan (Excl. Veterans) <input type="checkbox"/> 153 Recovery of Overpayment of Veteran's Benefits <input type="checkbox"/> 160 Stockholders' Suits <input type="checkbox"/> 190 Other Contract <input type="checkbox"/> 195 Contract Product Liability <input type="checkbox"/> 196 Franchise REAL PROPERTY <input type="checkbox"/> 210 Land Condemnation <input type="checkbox"/> 220 Foreclosure <input type="checkbox"/> 230 Rent Lease & Ejectment <input type="checkbox"/> 240 Torts to Land <input type="checkbox"/> 245 Tort Product Liability <input type="checkbox"/> 290 All Other Real Property	TORTS PERSONAL INJURY <input type="checkbox"/> 310 Airplane <input type="checkbox"/> 315 Airplane Product Liability <input type="checkbox"/> 320 Assault, Libel & Slander <input type="checkbox"/> 330 Fed. Employers' Liability <input type="checkbox"/> 340 Marine <input type="checkbox"/> 345 Marine Product Liability <input type="checkbox"/> 350 Motor Vehicle <input type="checkbox"/> 355 Motor Vehicle Product Liability <input type="checkbox"/> 360 Other Personal Injury <input type="checkbox"/> 362 Personal Injury-Med Malpractice <input type="checkbox"/> 365 Personal Injury-Product Liability <input type="checkbox"/> 368 Asbestos Personal Injury Product Liability IMMIGRATION <input type="checkbox"/> 462 Naturalization Application <input type="checkbox"/> 463 Habeas Corpus-Alien Detainee <input type="checkbox"/> 465 Other Immigration Actions	TORTS PERSONAL PROPERTY <input type="checkbox"/> 370 Other Fraud <input type="checkbox"/> 371 Truth in Lending <input type="checkbox"/> 380 Other Personal Property Damage <input type="checkbox"/> 385 Property Damage Product Liability BANKRUPTCY <input type="checkbox"/> 422 Appeal 28 USC 158 <input type="checkbox"/> 423 Withdrawal 28 USC 157 CIVIL RIGHTS <input type="checkbox"/> 441 Voting <input type="checkbox"/> 442 Employment <input type="checkbox"/> 443 Housing/Accommodations <input type="checkbox"/> 444 Welfare <input type="checkbox"/> 445 American with Disabilities - Employment <input type="checkbox"/> 446 American with Disabilities - Other <input type="checkbox"/> 440 Other Civil Rights	PRISONER PETITIONS <input type="checkbox"/> 510 Motions to Vacate Sentence Habeas Corpus <input type="checkbox"/> 530 General <input type="checkbox"/> 535 Death Penalty <input type="checkbox"/> 540 Mandamus/Other <input type="checkbox"/> 550 Civil Rights <input type="checkbox"/> 555 Prison Condition FORFEITURE / PENALTY <input type="checkbox"/> 610 Agriculture <input type="checkbox"/> 620 Other Food & Drug <input type="checkbox"/> 625 Drug Related Seizure of Property 21 USC 881 <input type="checkbox"/> 630 Liquor Laws <input type="checkbox"/> 640 R.R. & Truck <input type="checkbox"/> 650 Airline Regs <input type="checkbox"/> 660 Occupational Safety/Health <input type="checkbox"/> 690 Other	LABOR <input type="checkbox"/> 710 Fair Labor Standards Act <input type="checkbox"/> 720 Labor/Mgmt. Relations <input type="checkbox"/> 730 Labor/Mgmt. Reporting & Disclosure Act <input type="checkbox"/> 740 Railway Labor Act <input type="checkbox"/> 790 Other Labor Litigation <input type="checkbox"/> 791 Empl. Ret. Inc. Security Act PROPERTY RIGHTS <input type="checkbox"/> 820 Copyrights <input checked="" type="checkbox"/> 830 Patent <input type="checkbox"/> 840 Trademark SOCIAL SECURITY <input type="checkbox"/> 861 HIA (1395ff) <input type="checkbox"/> 862 Black Lung (923) <input type="checkbox"/> 863 DIWC/DIWW (405(g)) <input type="checkbox"/> 864 SSID Title XVI <input type="checkbox"/> 865 RSI (405(g)) FEDERAL TAX SUITS <input type="checkbox"/> 870 Taxes (U.S. Plaintiff or Defendant) <input type="checkbox"/> 871 IRS-Third Party 26 USC 7609
---	--	--	---	---	--

CV12-09703

FOR OFFICE USE ONLY: Case Number: _____

AFTER COMPLETING THE FRONT SIDE OF FORM CV-71, COMPLETE THE INFORMATION REQUESTED BELOW.

**UNITED STATES DISTRICT COURT, CENTRAL DISTRICT OF CALIFORNIA
CIVIL COVER SHEET**

VIII(a). IDENTICAL CASES: Has this action been previously filed in this court and dismissed, remanded or closed? No Yes
If yes, list case number(s): _____

VIII(b). RELATED CASES: Have any cases been previously filed in this court that are related to the present case? No Yes
If yes, list case number(s): _____

Civil cases are deemed related if a previously filed case and the present case:

- (Check all boxes that apply) A. Arise from the same or closely related transactions, happenings, or events; or
 B. Call for determination of the same or substantially related or similar questions of law and fact; or
 C. For other reasons would entail substantial duplication of labor if heard by different judges; or
 D. Involve the same patent, trademark or copyright, and one of the factors identified above in a, b or c also is present.

IX. VENUE: (When completing the following information, use an additional sheet if necessary.)

(a) List the County in this District; California County outside of this District; State if other than California; or Foreign Country, in which **EACH** named plaintiff resides.
 Check here if the government, its agencies or employees is a named plaintiff. If this box is checked, go to item (b).

County in this District:*	California County outside of this District; State, if other than California; or Foreign Country
	San Mateo County

(b) List the County in this District; California County outside of this District; State if other than California; or Foreign Country, in which **EACH** named defendant resides.
 Check here if the government, its agencies or employees is a named defendant. If this box is checked, go to item (c).

County in this District:*	California County outside of this District; State, if other than California; or Foreign Country
Los Angeles County	

(c) List the County in this District; California County outside of this District; State if other than California; or Foreign Country, in which **EACH** claim arose.
Note: In land condemnation cases, use the location of the tract of land involved.

County in this District:*	California County outside of this District; State, if other than California; or Foreign Country
Los Angeles County	

* Los Angeles, Orange, San Bernardino, Riverside, Ventura, Santa Barbara, or San Luis Obispo Counties
 Note: In land condemnation cases, use the location of the tract of land involved

X. SIGNATURE OF ATTORNEY (OR PRO PER): John V. Tamm Date Nov. 9, 2012

Notice to Counsel/Parties: The CV-71 (JS-44) Civil Cover Sheet and the information contained herein neither replace nor supplement the filing and service of pleadings or other papers as required by law. This form, approved by the Judicial Conference of the United States in September 1974, is required pursuant to Local Rule 3-1 is not filed but is used by the Clerk of the Court for the purpose of statistics, venue and initiating the civil docket sheet. (For more detailed instructions, see separate instructions sheet.)

Key to Statistical codes relating to Social Security Cases:

Nature of Suit Code	Abbreviation	Substantive Statement of Cause of Action
861	HIA	All claims for health insurance benefits (Medicare) under Title 18, Part A, of the Social Security Act, as amended. Also, include claims by hospitals, skilled nursing facilities, etc., for certification as providers of services under the program. (42 U.S.C. 1935FF(b))
862	BL	All claims for "Black Lung" benefits under Title 4, Part B, of the Federal Coal Mine Health and Safety Act of 1969. (30 U.S.C. 923)
863	DIWC	All claims filed by insured workers for disability insurance benefits under Title 2 of the Social Security Act, as amended; plus all claims filed for child's insurance benefits based on disability. (42 U.S.C. 405(g))
863	DIWW	All claims filed for widows or widowers insurance benefits based on disability under Title 2 of the Social Security Act, as amended. (42 U.S.C. 405(g))
864	SSID	All claims for supplemental security income payments based upon disability filed under Title 16 of the Social Security Act, as amended.
865	RSI	All claims for retirement (old age) and survivors benefits under Title 2 of the Social Security Act, as amended. (42 U.S.C. (g))